

## 01 Industrial carbon brushes



Technical data  
Standard brush grades  
P. 04 – 07

Carbon brushes with switch off and signalling unit  
Maintenance and care of collectors and slip rings  
P. 08 – 10

Design types, basic shapes  
and cable shoe shapes  
P. 11 – 17

# Industrial carbon brushes

## Foreword

Carbon brushes have many applications in the industrial and private sectors.

A multitude of applications determine the geometry and designs of our industrial carbon brushes.

In an electric motor the carbon brushes take on the task to apply the voltage on to the collector and thus transfer the electric current through the armature winding.

For the energy transmission to rotating slip rings or linear conductor lines, primarily graphite materials and metal graphites are used. Metal graphites can conduct higher current loads due to their metal content.

Static charges caused by the rotating shafts are safely diverted by our carbon brushes made of metal and silver graphite.

Industrial carbon brushes made of metal graphite are also used in the grounding area.

Due to the very good physical characteristics, outstanding chemical and thermal resistance and their excellent gliding properties, our graphite materials are also used in the mechanical sector as bearing and sealing materials.

According to the area of application graphite and carbon materials are manufactured with various quality features. Based on our decades of experience, we develop solution suggestions together with our customers, and thereby consider the individual wishes and requirements.





**Industrial carbon brushes for wind turbines.**

# Standard brush grades for carbon blocks

## Hard carbon

Hard carbons are produced from amorphous types of carbon such as retort coke and soot. They have a firm structure, high hardness and a good cleaning effect. Hard carbons are used in commutators with flush and sometimes recessed mica insulation.

The physical properties of these grades can be optimised by the use of special impregnations.

### Areas of use:

Current collector carbon brushes, contacts, universal motors, power tools, domestic appliances.

## Carbon graphite

For difficult commutation, high peripheral speeds and minimizing radiointerference, carbon brushes have high electrical resistance. In connection with the good strength values these carbon brushes work in very diverse areas.

### Areas of use:

Many domestic appliances, electrical power tools such as drilling machines, angle grinders and electrical chainsaws.

## Natural Graphite carbons

Natural graphite carbons are made from various graphites and carbons. Due to the mineral content, the good glide properties are combined with a slight grinding effect. The mica insulation of the collector must be recessed.

Carbon brushes made of these materials are able to remove weak burrs on the collector and sliprings.

### Areas of use:

Machines with high peripheral speeds, turbo generators, small and medium sized motors, universal motors or alternators.



T3i graphite carbon

## Resin bonded graphite carbons

They form an extension of the graphite carbons and primarily stand out due to their high resistance, high transient voltages and large ratio of leak to series resistance. This has a positive effect on the attenuation of commutating currents.

### Areas of use:

Small and medium sized generators up to 30 kW, auxiliary brushes for quadrature excitation, three phase current commutator motors, regulating motors, frequency converters and universal motors.

## Electrographite carbon grades

Electrographite carbon brushes are produced from pre-annealed and solidified carbon material. At temperatures of over 2500°C the conversion from carbon to electrographite occurs in the graphitisation furnace. During the graphitisation the material is mostly freed of impurities. The high grade carbon brushes stand out due to their good physical values. They have good commutation characteristics, high short circuit security, high combustion resistance and good thermal conductivity. The mica insulation must be recessed.

### Areas of use:

Direct current motors of any power output, three phase current commutator motors, alternating current motors, drive motors for trains and trams, idle power machines, slip ring power transmissions, welding converters, universal motors, synthesisers.

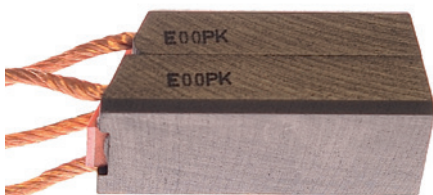

E00PK electrographite carbon brush

## Metalgraphite carbons

Carbon brushes containing metal are produced from graphite and other carbons, with the addition of metals. Due to the metal content they have significantly higher conductivity and lower specific resistance and a higher electrical capacity.

Carbon brushes with a high copper content can be used on slip rings or shafts for energy transmission or current derivation.

### Areas of use:

Earthing brushes, direct current low voltage machines, car starter motors, slip and exciter rings, synchronised asynchronous motors and conductor lines.

## Hot pressed metal carbon brushes

Grades with a high metal content are suitable for the transfer of very high energy densities. For this purpose we recommend our grades, which are produced in a special manufacturing process. Hot pressed metal carbon brushes stand out due to their excellent physical running characteristics and their high electrical capacity.

### Areas of use:

High load carbon brushes for galvanics, welding machines, moving welding current transmissions, annealing systems, automotive carbon brushes, slip rings and conductor lines.

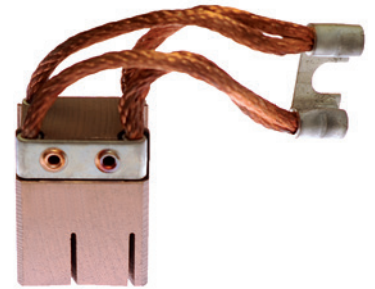

N51 hot pressed metal carbon

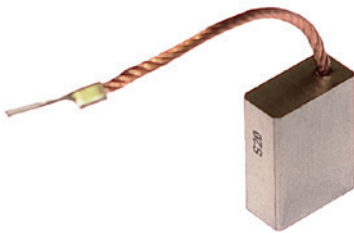

S20 silver graphite carbon

## Silver graphite carbons

Silver graphite materials are produced from high purity graphite and silver powder.

The chemical resistance of silver has a particularly positive effect when used under various climatic conditions.

### Areas of use:

Shaft earthing, small motors with low voltages, tachogenerators, transfer of measurement, regulating and control currents.

## Proofing

The characteristics of our grades can be improved using various additional treatments. According to the type of proofing the carbon brushes can for example have better gliding properties, higher strengths or lower spark formation.

# Standard brush grades for carbon plates

## Hard carbon brushes

Brand	Specific resistance (Ohm* mm <sup>2</sup> /m)	Density (g/cm <sup>3</sup> )	Flexural strength (N/mm <sup>2</sup> )	Rockwell hardness HR <sub>10/40</sub>	Continuous load (A/cm <sup>2</sup> )	Speed (m/s)	Voltage drop (V)	Friction coefficient μ	Metal content %
H2	40	1,45	18	110	7	25	n	m	
H4	45	1,52	24	110	8	40	n	n	
H4S2	45	1,53	23	112	8	40	n	m	
H6	40	1,53	38	115	8	30	n	n	
H47	250	1,46	20	102	8	40	h	m	
H67	250	1,48	18	110	8	40	h	m	
H6K*	5	2,20	50	124	12	25	n	h	30
H6Sb*	9	2,80	60	128	14	25	n	h	45
H6Mb*	5	3,40	70	130	15	25	n	h	55

\* impregnated with metal

## Carbon graphite brushes

V12	250	1,56	25	112	8	45	h	n	
H12	800	1,55	24	110	8	45	h	s.n.	
H16	500	1,34	18	60	8	45	h	s.n.	
H20	100	1,52	35	120	8	40	m	m	
H22	1000	1,60	28	120	8	45	h	n	

## Graphite carbon brushes

G3	35	1,45	18	95	8	20	n	n	
G4	35	1,40	15	90	10	25	n	n	
G6	25	1,55	12	85	10	25	n	n	
G1	7	1,80	18	100*	10	35	n	n	
T1	12	1,48	15	100*	10	45	n	n	
TU	12	1,40	5	30*	10	60	n	n	
T3	25	1,45	7	75*	10	75	n	n	
G47	400	1,38	12	75	8	25	m	h	
G67	250	1,45	10	70	8	25	m	n	

\* HR<sub>10/20</sub>

## Graphite carbon brushes, resin bonded

UG75	15	1,80	16	100	8	30	n	n	
UG	80	1,75	15	100	8	35	m	n	
UG1	450	1,70	31	110	5	35	s.h.	n	
UG2	600	1,65	37	115	5	35	s.h.	n	
UG8	120	1,75	18	100	8	40	h	n	
UG9	190	1,52	10	60	8	40	h	n	
UG12	220	1,75	22	105	8	40	h	n	
UG91	300	1,52	12	80	8	40	h	n	
V421	220	1,62	18	90	10	40	h	n	
V434*	2400	1,55	-	-	5	35	h	n	
UC4	350	1,75	25	110	9	40	h	n	
UC15	14	1,85	27	120	12	35	h	n	
UG25	-	1,55	20	110	8	35	Lubricating brushes	n	

\* available as pellets

## Silver graphite brushes\*\*

Brand	Specific resistance (Ohm* mm <sup>2</sup> /m)	Density (g/cm <sup>3</sup> )	Rockwell hardness HR <sub>10/40</sub>	Continuous load (A/cm <sup>2</sup> )	Speed (m/s)	Voltage drop (V)	Friction coefficient μ	Metal content (%)
S5	0,03	7,80	118	35	20	s.n.	h	95
S10	0,05	6,80	110	30	20	s.n.	h	90
S20	1,00	5,20	105	28	25	s.n.	m	80
S30	2,00	4,30	103	25	25	s.n.	n	70
S35	4,00	4,00	100	20	30	s.n.	n	65
S50	5,00	3,20	95	20	30	n	n	50
S60	6,00	2,90	85	20	40	n	s.n.	40

\*\* further silver grades on request



## Electrographite carbon brushes

Brand	Specific resistance (Ohm* mm <sup>2</sup> /m)	Density (g/cm <sup>3</sup> )	Flexural strength (N/mm <sup>2</sup> )	Rockwell hardness HR <sub>10/40</sub>	Continuous load (A/cm <sup>2</sup> )	Speed (m/s)	Voltage drop (V)	Friction coefficient μ
ET2	9	1,32	5	20	10	60	n	n
E	16	1,57	20	110	12	50	n	n
E00	20	1,46	20	105	12	40	n	n
E02	22	1,57	22	110	12	40	n	n
E04	28	1,60	23	112	12	40	n	n
E06	32	1,63	26	115	12	50	n	n
E08	45	1,58	28	118	12	50	m	n
E09	49	1,62	25	120	12	50	h	n
E09 G5*	48	1,62	24	118	12	50	h	n
E010	52	1,60	27	120	12	50	h	n
E012	90	1,42	20	115	12	50	h	n
E31	45	1,60	26	115	12	50	h	m
E661	35	1,60	17	110	12	40	s.h.	n
E861	40	1,60	14	115	12	40	s.h.	n
E961	48	1,62	18	115	12	40	s.h.	n
E062	52	1,62	15	118	12	45	s.h.	h

\* formerly V436

## Metal graphite brushes, cold pressed

Brand	Specific resistance (Ohm* mm <sup>2</sup> /m)	Density (g/cm <sup>3</sup> )	Flexural strength (N/mm <sup>2</sup> )	Rockwell-hardness HR <sub>10/40</sub>	Continuous load (A/cm <sup>2</sup> )	Speed (m/s)	Voltage drop (V)	Friction coefficient μ	Metal content (%)
K	10	2,40	20	80	12	30	n	n	47
K3	8	2,80	27	90	13	25	n	n	60
K4	7	3,00	30	90	15	20	n	n	70
KM1	2	3,10	36	100	13	25	n	n	63
2378	0,5	3,90	28	100	15	35	n	n	70
3316	1,0	3,60	25	95	13	40	n	n	65
3344	1,2	3,50	21	95	13	40	n	n	60
4350	2,2	3,00	19	90	13	40	n	n	50
5246	5,0	2,70	17	85	12	40	n	n	40
6235	6,0	2,50	16	80	12	40	n	s.n.	30
7274	8,0	2,20	15	80	12	45	n	s.n.	20
065	0,5	4,00	26	100	15	35	n	n	70
N46	3,0	3,10	20	90	13	40	n	n	50
V444	0,5	4,00	30	110	15	35	n	n	75

## Metal graphite brushes, hot pressed

0555	0,06	5,50	80	125	30	-	-	-	95
1503	0,08	5,30	62	110	25	-	-	-	90
1531	0,09	5,00	60	100	22	20	s.n.	n	87
BR	0,10	4,90	55	100	22	20	s.n.	n	85
2454	0,12	4,30	50	98	18	30	s.n.	n	75
3402	0,15	4,20	40	95	16	35	s.n.	s.h.	70
3450	0,15	4,00	30	90	15	40	s.n.	s.h.	65
085	0,3	5,40	90	110	30	20	n	n	96
N6	0,3	6,00	140	110	40	20	s.n.	m	91
N8	0,6	5,00	110	85	35	20	s.n.	n	86
N10	0,1	6,10	70	80	40	20	s.n.	n	93
N51	0,1	5,50	30	50	40	25	s.n.	n	90
N52	0,1	6,70	90	105	40	20	s.n.	m	95,5
N55	0,1	6,60	85	100	40	20	s.n.	m	95
N91	0,1	5,20	30	50	35	30	s.n.	m	86
V682	0,2	5,65	25	112	30	30	n	n	88
V816i	2	3,00	24	100	13	40	n	n	50

### Key

#### Voltage drop:

s.n. (very low) = < 1,0 V  
n (low) = 1,0 – 1,8 V

m (medium) = 1,8 – 2,5 V  
h (high) = 2,5 – 3,5 V  
s.h. (very high) = > 3,5 V

#### Friction coefficient:

s.n. (very low) = < 0,15  
n (low) = 0,15 – 0,20

m (medium) = 0,20 – 0,26  
h (high) = > 0,26

# Carbon brushes with switch off and signalling unit

## 1. Switch off unit = AB

The switch off unit is automatically effective, if the wear on the carbon is great enough that a replacement is necessary. This means that checking and monitoring the carbon brush are omitted. Our switch off device is largely temperature resistant. It can be used both for motors with low current load (power supply via carbon with spring), and for motors with high current load (power supply via carbon with strand); e.g. power tools, domestic appliances etc.

Functioning: If the carbon brush has achieved its wear limit, the switch off nipple suddenly protrudes from inside it, and safely and quickly lifts the brush off from the collector. The current flow is interrupted and the machine comes to a standstill. Further damage to collector is avoided.

With our smallest switch off device the switch off point is at a residual carbon length of approx. 5.5 mm, for the medium one at approx. 7 mm and for the largest between 9 and 13 mm. The size of the switch off device depends on the carbon brush cross section.

This should be at least 2 cm<sup>2</sup>. For larger carbon cross sections we recommend using our signalling device.

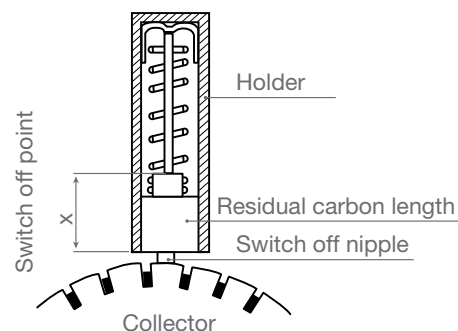

## 2. Signalling device

Brush monitoring brings optimum operating security for electromotors and generators. In order to reduce the continual maintenance of current transmission systems, it was necessary to find a device which signals the upcoming breakdown of the carbon brush caused by wear, in advance.

### Design shape

The signal contact occurs via the copper strand and the collector or slip ring. This design saves space. The carbon brush should not continue to be in operation for significantly longer after the signal. The copper strand can cause breakdown of the patina, and can also slightly attack the collector or slip ring.

Maintenance and switching units for the signalling units are available from us.

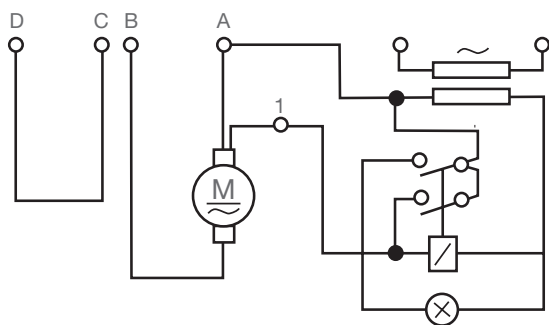
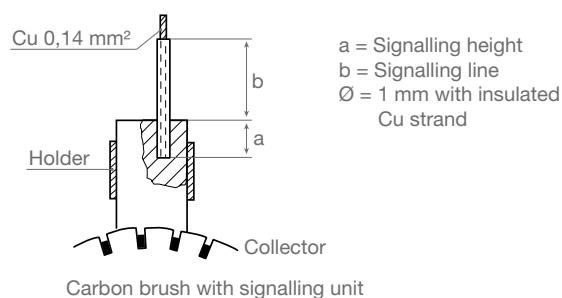

Switching with auxiliary circuit

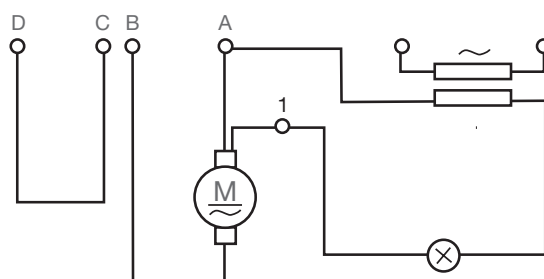

Switching without auxiliary circuit



# Maintenance and care of collectors and slip rings

## Commutators and slip rings

To avoid mechanical disturbances the slip rings and collectors must run smoothly. In this way brush sparking and serious burn off of the carbon brush and burning in of the running surface can be avoided. In the case of recessed mica insulation the utmost care should be taken during milling works. The following image shows what you should look out for.

### Image 1:

- a: bevel too strong, smooth operation of brush will be influenced negatively.
- b: recess too wide, serious brush imbalance.
- c: remaining residual insulation (mica) can not be worn away by soft carbon material.

### Image 2:

Here it is clear how it should be milled; a bevel is not necessary in most cases, if the collector is turned precisely.

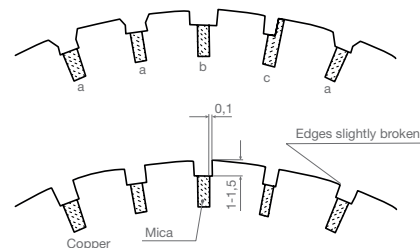

Cleanliness should be ensured, so that wear dust from the carbon brush and foreign impurities do not settle in the recessed insulation slots and hereby cause operational disturbances.

## Brush assembly

Correct allocation of the carbon brushes on the commutator is necessary. The brush division should be as precise as possible so that good commutation, reduction of lamella sparking and balance of the polar and electrolytic effect are ensured. The carbon brushes sitting on a bolt must be aligned exactly, taking into consideration a possible designated gradation.

Recommended gap of holder-collector: 2,5 to 3 mm

As cathodic brushes (plus brush generator/minus brush motor) are almost always responsible for an electrical weakening of the grinding body, it should be ensured that they are distributed as evenly as possible across its width.

The distribution of the anodic carbon brushes is not significant, however it is good from a mechanical point of view, if the carbon brushes of two neighbouring bolts are precisely behind each other. This is particularly electrically necessary in the case of reverse motors, as the polarity often changes here. An axial staggering of the brushes (see image) is necessary, so that no untraveled strips emerge. In order to achieve an evenly coloured patina, the same number of brushes should be ensured in all runways as far as possible.

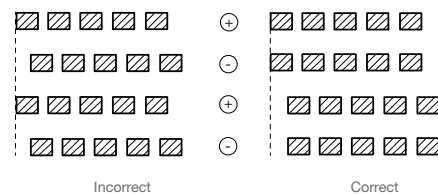

## Attaching carbon brushes

Carbon brushes for larger overlaps (t larger than 6mm) should continually be ground in. Pull a longer strip of emery cloth, which is laid out on a large part of the grinding wheel, back and forth underneath the carbon brushes. The grinding in takes place at normal brush pressure, which is given by the holder. Under no circumstances should the pressure be increased by additional pressing on by hand. For machines that run only in one direction of rotation, the emery cloth should only be pulled underneath the overlying carbon brush in the same direction of rotation.

When withdrawing the brush must be lifted. The grinding in can be carried out quicker using an artificial pumice stone. This is placed in front of the carbon brush when the machine is running, so that the grains flying off cope with the grinding in procedure. In just a short time the correct radius is ground in and a flush fitting of the carbon running surface is guaranteed. After grinding in, the grinding wheel and the running surface of the carbon brush should be carefully cleaned. Hereby, it should be ensured that the dust is not blown into the winding. Artificial pumice stones (commutator grinders) are available from us.

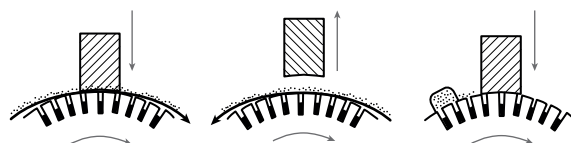

Seating in with emery cloth and pumice stone

## Brush pressure

The brush pressure significantly influences the correct working of the carbon brushes and is therefore an important factor, which is often not given enough consideration. The electrical and mechanical wear of the carbon brushes are significantly influenced by this.

Assuming normal conditions, the brush pressures for various machines are shown in the table below as rough reference values.

Machine type	Spec. brush pressure N/cm <sup>2</sup>	Machine type	Spec. brush pressure N/cm <sup>2</sup>
Universal motor (FHP)	2,0 – 4,0	Tram way motors	3,5 – 5,0
Stationary converters	1,8 – 3,0	Trolley bus motors	3,0 – 4,5
Slip ring motors	1,5 – 2,5	Traction motors	2,5 – 4,0
Steel slip rings	1,2 – 1,4	Mine railways and crane motors	4,5 – 6,0

In individual cases the brush pressure depends on the brush operating conditions and the brush grade. In case of uncertainty we can provide information about the relevant suitable brush pressure.

# Request and order details for carbon brushes

## The following details are necessary

### 1. Dimensions of the carbon brushes

Tangential direction = t  
 Axial direction = a  
 Radial direction = r

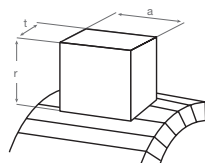

Commutator

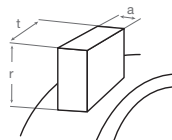

Slip ring

Dimensions and tolerances are designed in accordance with DIN IEC 43000 sheet 1 + 2.

### 2. Design of carbon brushes

2.1. Design types table page 11 (processing the head and running surface)

2.2. Basic shapes according to tables page 12 – 16

2.3. See image for details of visible cable length!

The cable diameter is determined according to DIN 43002. Each cable can be provided with insulation.

Standard: silicone tubing, other designs according to details, e.g. Diolen tubing etc.

If tin plated or silver plated cable is desired, then this must be stated on ordering.

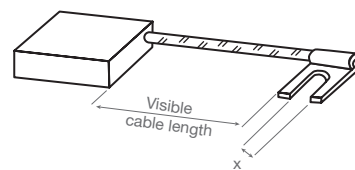

2.4. Cable shoes and plug according to table page 17. Measurements for slot width and/or hole diameter or plug diameter must be stated.

2.5. Details on copper plating, tin plating or silver plating of the contact surfaces are desired.

2.6. If the stability of the carbon material and the cross section of the carbon brush allow it, the fastening of the cable will be carried out by tamping contact (standard design). The well designed tamping contact offers a low voltage drop and mechanically a high strain.

If the carbon brushes are provided with a fitting (metal parts, bracket, support frame etc.), the fastening is carried out with rivets. If another cable fastening is required, e.g. soldering, then this must be stated.

### 3. Special design

If carbon brushes are required, which are not included in the table, of course a delivery is possible. In such cases we ask that you send a sample or a drawing with the dimensions and designs of the carbon brush. Details about the brush grade, make and quality description, description of the purpose and details of the operating data currently being used are necessary for the correct selection of the carbon brush.

### 4. Mounting questions

Our technical departments will help and support you in clarifying special questions about mounting and design of carbon brushes on electrical machines, power transmission equipment etc.

### 5. Ordering examples

Example	Quality	Dimensions t x a x r	Basic form image no.	Design type	Visible cable length mm	Cable shoe image no.	Remark
1	E09	12,5 x 32 x 32	305	D	80	53	Radius 100 mm Angel 45° insul. = i
2	3450	40 x 20 x 40	718	B	90	4	

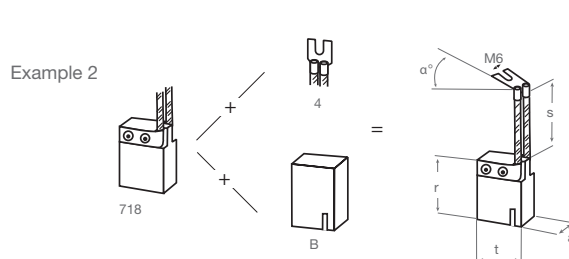
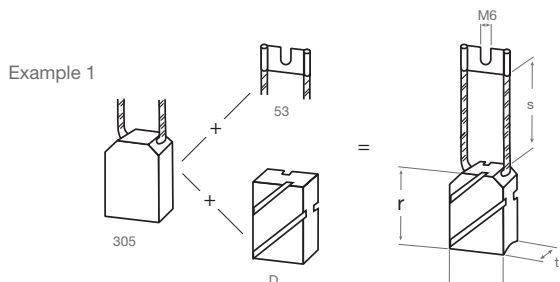

E09	12,5 x 32 x 32	305	D	80	53	M6	R=100	3450	40 x 20 x 40	718	B	90i	4	45°	M6
-----	----------------	-----	---	----	----	----	-------	------	--------------	-----	---	-----	---	-----	----

# Design types

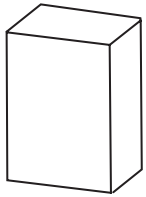

A  
Standard

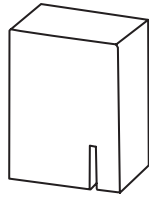

B  
Dust groove

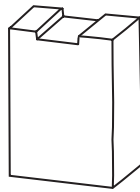

C  
Head slot

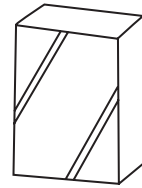

D  
Dust groove

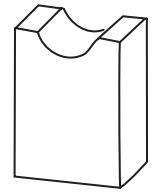

E  
Head slot

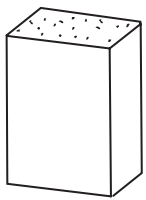

F  
Head hardening

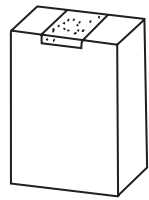

G  
Head plates

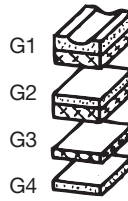

 Laminate  
 Rubber

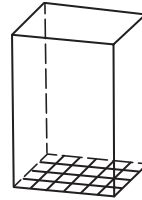

H  
Fluting

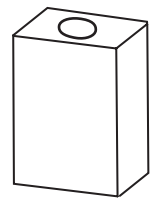

J  
Head drill hole

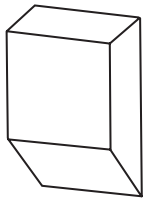

K  
Contact bevel

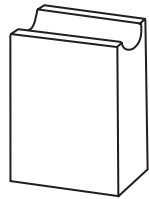

L  
U-slot

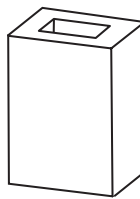

M  
Head mould

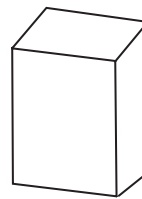

N  
Top bevel

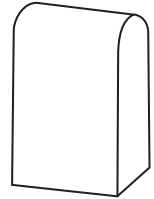

O  
Top radius

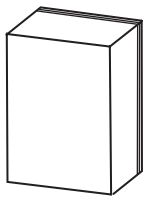

P  
Carbon brush layer

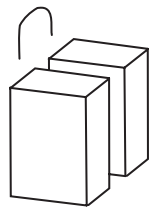

Q  
Pair of carbon brushes

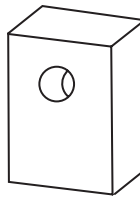

R  
Drill hole

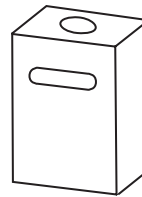

S  
Nut insert

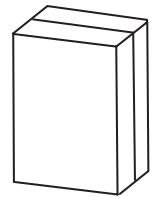

T  
Twin

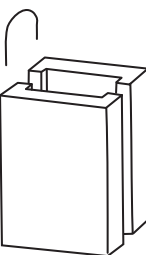

U  
Twin and cooling slot

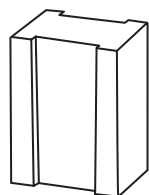

V  
Dust groove

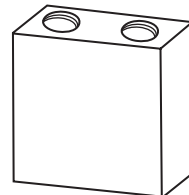

W  
Threads

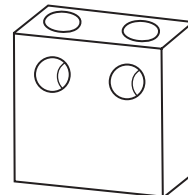

X  
Nut insert

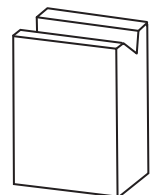

Y  
Head notch

# Basic shape

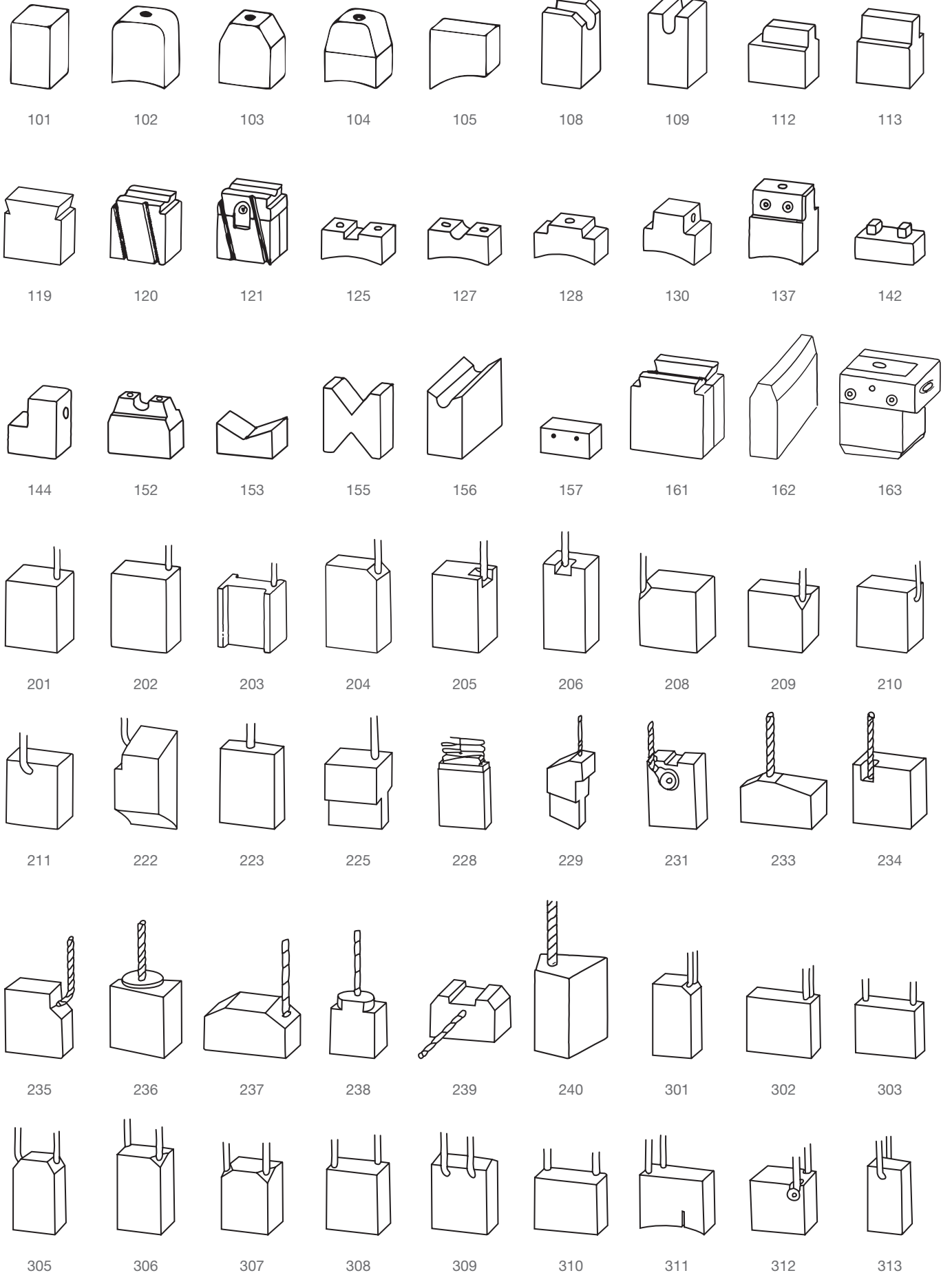

# Basic shape



# Basic shape

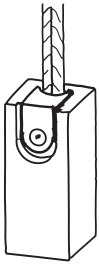

543

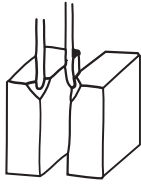

605

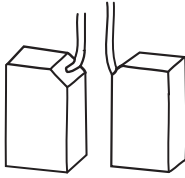

607

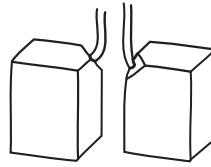

608

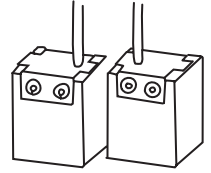

610

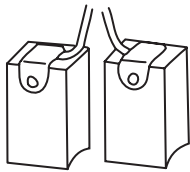

612

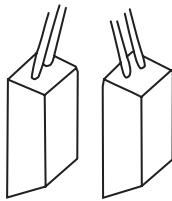

613

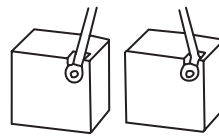

614

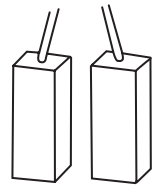

615

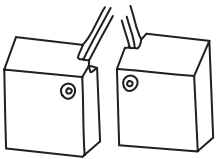

616

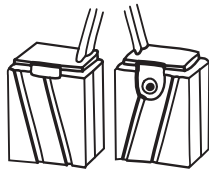

617

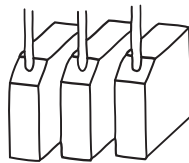

618

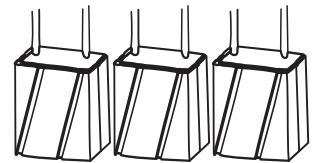

619

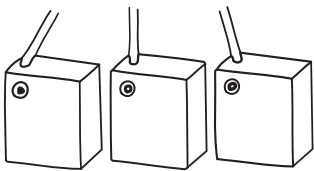

620

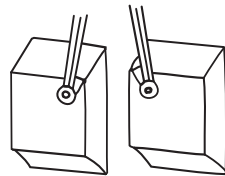

621

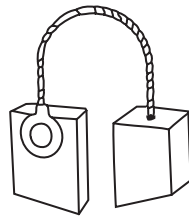

622

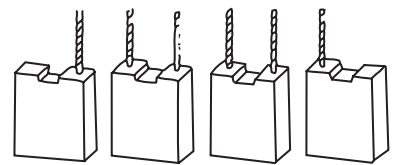

623

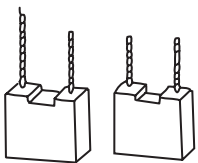

624

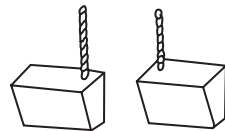

625

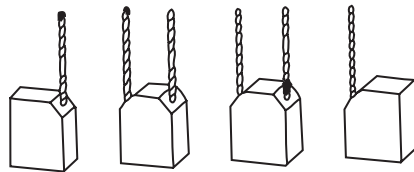

626

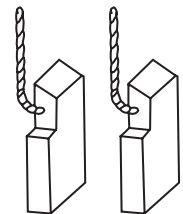

627

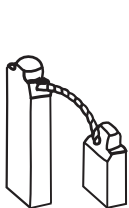

628

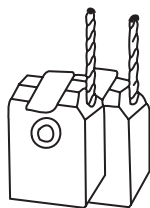

629

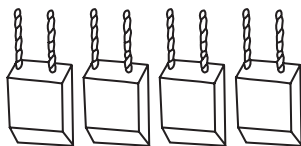

630

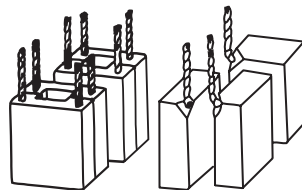

631

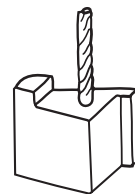

632

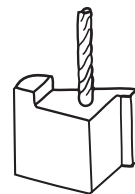

633

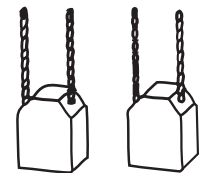

634

# Basic shape

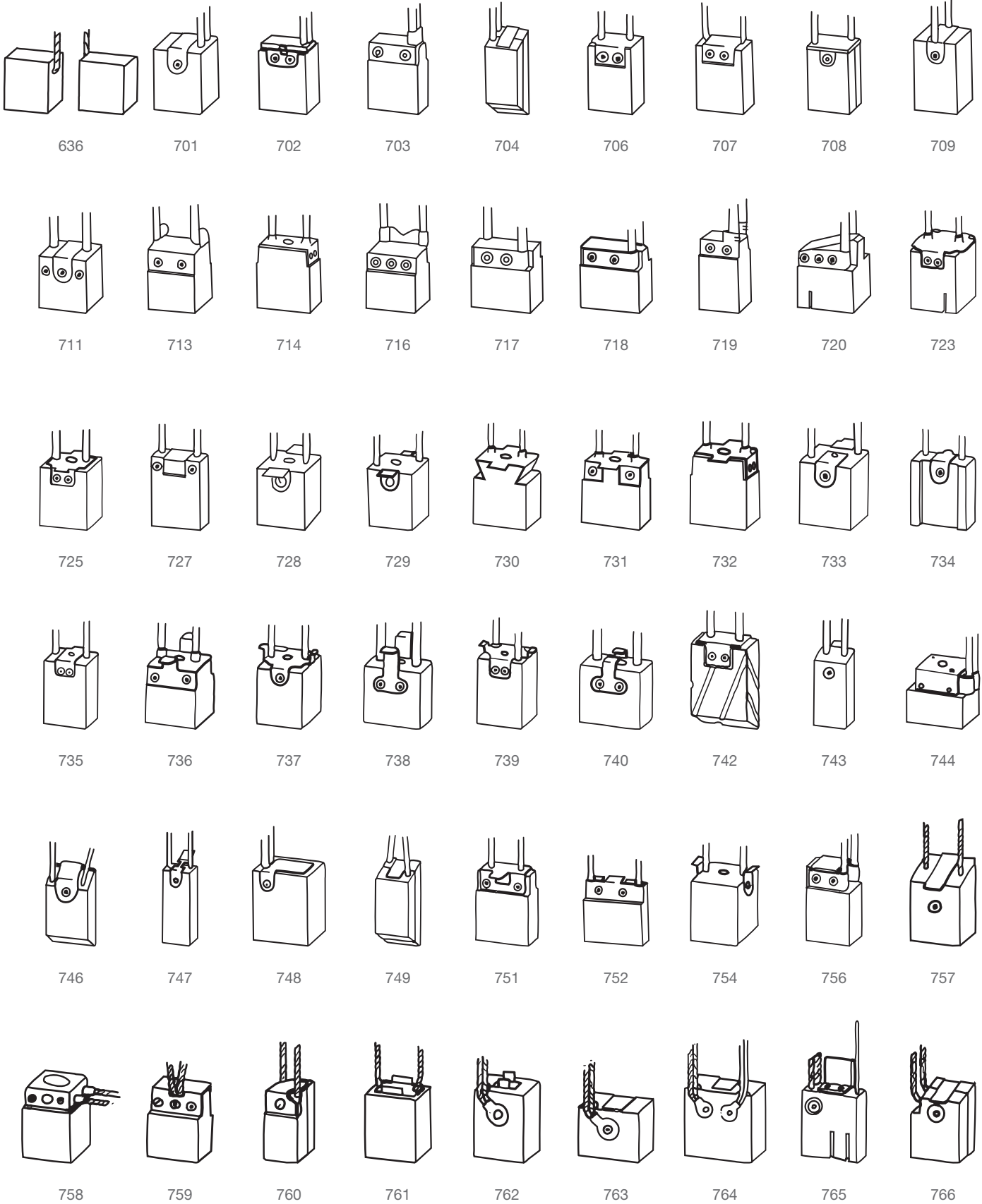

# Basic shape

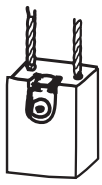

767

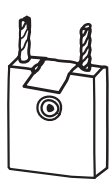

768

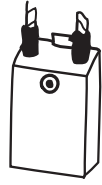

769



770



771

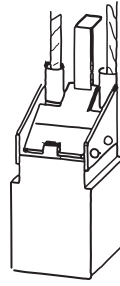

772

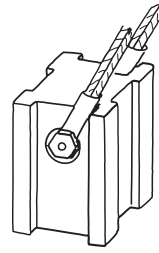

773

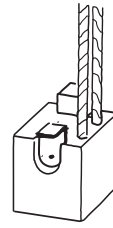

774

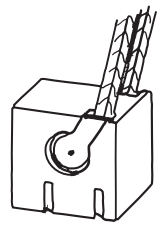

775

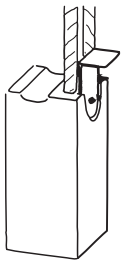

776

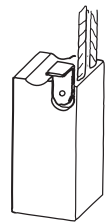

777

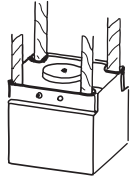

778

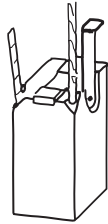

779

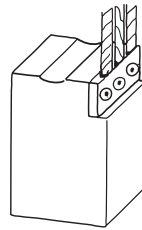

780

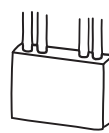

801

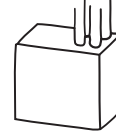

803

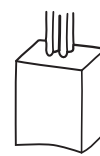

804

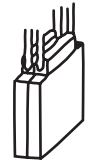

808



809

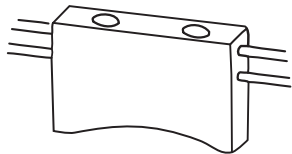

810



811



812

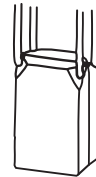

813



814

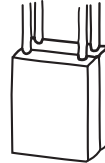

815

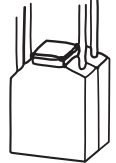

816



817

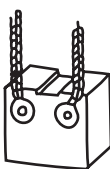

818



819

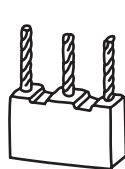

823

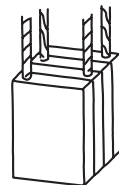

828



901

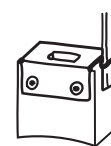

902



903

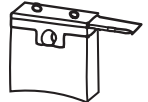

904

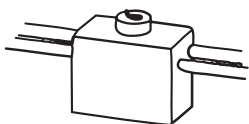

906

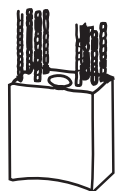

909



910

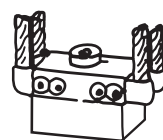

911

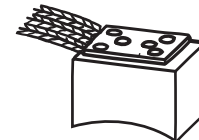

912

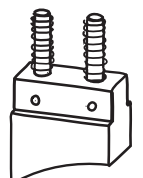

913

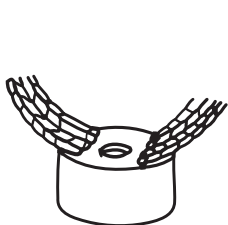

914

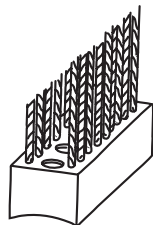

915

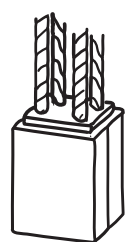

916

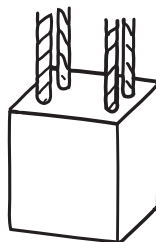

917

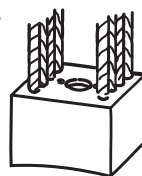

918

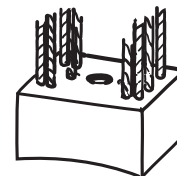

919



920



# Cable shoe shape



1



2



3



4



5



6



7



8



9



10



11



12



13



14



15



16



17



18



19



20



21



22

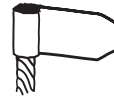

23



24

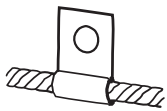

25

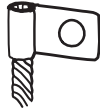

26



27



28

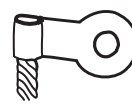

29

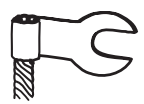

30

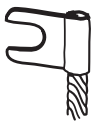

31

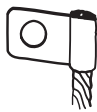

32



33

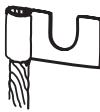

34



35

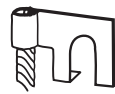

36

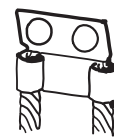

37

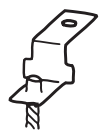

38



39



40

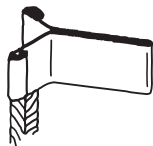

41

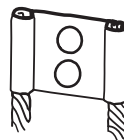

42

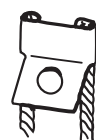

43

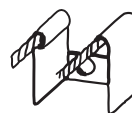

44

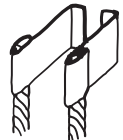

45

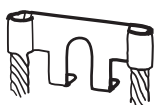

46

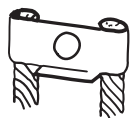

47

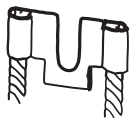

48

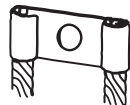

49

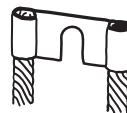

50

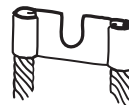



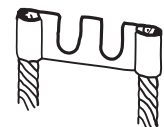







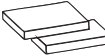







51



52



# Our range of products

00	Carbon blocks	
01	Industrial carbon brushes	
02	Midget carbon brushes	
03	Micro carbon brushes	
04	Automotive carbon brushes	
05	Carbon contacts   carbon rolls	
06	High current carbon brushes	
07	Carbon inserts	
08	Carbon profiles	
09	Carbon vanes	
10	Graphite lubricating brushes	
11	Carbon bearings	
12	Thermistors	
13	Special armatures for brushes	
14	Flexible copper conductors	
15	Carbon welding rods	
16	Carbon brushes for fork lift trucks	
17	Holders for carbon brushes	
18	Special carbon brushes	

# Schmidthammer Elektrokohle GmbH

Walpersdorfer Str. 33-39  
D-91126 Schwabach

**Fon:** +49 (0)9122 - 18 06-0

**Fax:** +49 (0)9122 - 18 06-60

**Mail:** [mega@schmidthammer.com](mailto:mega@schmidthammer.com)

[www.schmidthammer.com](http://www.schmidthammer.com)

