



# VARVEL®

MOTION CONTROL SINCE 1955

technology made in Italy



IT  
EN  
DE

## RS·RT



## Tecnologia Made in Italy

IT

Dal 1955 il Gruppo Varvel progetta e realizza riduttori e variatori per applicazioni fisse di piccola e media potenza. Partner affidabile nella produzione e vendita di organi di trasmissione grazie a un elevato livello di servizio, offre anche soluzioni personalizzate operando nel rispetto dei valori dell'impresa socialmente responsabile. Modularità e flessibilità guidano la progettazione dei prodotti Varvel nella realizzazione di kit comuni a tutte le famiglie di riduttori, agevolando così l'attività di distributori e rivenditori che possono configurare in pochi minuti il prodotto richiesto dal singolo cliente.

## Technology Made in Italy

EN

Since 1955 the Varvel Group has been making speed reducers and variators for light industry applications. Reliable partner in power transmission equipment offers also customized solutions always according to a socially responsible company values. Modularity and flexibility lead Varvel products by a unique kit form, common to all gearbox series. This feature allows distributors an easier job to set up required products in few minutes.

## Technologie Made in Italy

DE

Seit 1955 plant und stellt die Varvel-Gruppe Getriebe und Verstellgetriebe für feste Kleinleistungsanwendungen her. Dank dem hohen Dienstniveau ist Varvel ein zuverlässiger Partner für Herstellung und Verkauf von Getriebewerkteilen und bietet maßgeschneiderte Lösungen an, in Verbindung mit sozialverträglicher Handlungsweise. Modularität und Flexibilität sind Kennzeichen für Varvel-Produkte. Die Firma produziert Teile, die sich für alle Getriebetypen eignen. Verteiler und Verkäufer können somit den Kundenanforderungen gerecht werden.



- UNI EN ISO 9001:2008
- UNI EN ISO 14001:2004
- BS OHSAS 18001:2007



- EC DIRECTIVE 2014/34/EU (ATEX)



# RS-RT

## RIDUTTORI A VITE SENZA FINE

- singolo stadio
- con precoppia cilindrica
- doppio stadio



## WORM GEAR BOXES

- single-stage worm
- helical / worm
- two-stage worm

## SCHNECKENGETRIEBE

- Einstufige
- mit Stirnradvorstufe
- Doppelstufige



INDICE 	CONTENTS 	INDEX 
Descrizione ..... 2-4	Product description ..... 2-4	Produkte ..... 2-4
Simboli ..... 5	Symbols ..... 5	Abkürzungen ..... 5
Modularità ..... 6-7	Modular system ..... 6-7	Modularsystem ..... 6-7
Giunto elastico „G“ ..... 8	Flexible coupling „G“ ..... 8	Kupplung „G“ ..... 8
Selezione Giunto elastico ..... 9	Flexible coupling Selection ..... 9	Kupplungsauswahl ..... 9
Flange IEC & Giunto ..... 10	IEC Flanges & flexible coupling ..... 10	IEC-Flansch u. Kupplung ..... 10
Flange NEMA & Giunto ..... 11	NEMA Flanges & flexible coupling ..... 11	NEMA-Flansch u. Kupplung ..... 11
Designazione Riduttore e Motore ..... 12	Gearbox & Motor Designation ..... 12	Getriebe- u. Motorbezeichnungen ..... 12
Catalogo elettronico VARsize ..... 13	VARsize electronic catalogue ..... 13	Elektronischer Katalog VARsize ..... 13
Posizioni di montaggio ..... 14-16	Mounting positions ..... 14-16	Einbaulage ..... 14-16
SF - Pesi - Olio - Carichi entrata ..... 17	SF - Weights - Oil - Input loads ..... 17	BF - Gewichte - Öl - Eingangkräfte ..... 18
Carichi uscita ..... 18	Output loads ..... 18	Ausgangkräfte ..... 18
Accoppiamenti motori ..... 19-20	Motor fitting ..... 19-20	Motorbaugröße ..... 19-20
<b>Tabelle di Selezione</b>	<b>Selection tables</b>	<b>Auswahltabelle</b>
Vite RS-RT ..... 21-24	Worm RS-RT ..... 21-24	Schneckengetriebe RS-RT ..... 21-24
Precoppia/vite RA-TA ..... 25-27	Helical/worm RA-TA ..... 25-27	Stirnrad/Schnecke RA-TA ..... 25-27
Doppio stadio RS/RS-RT/RT ..... 28	Two-stage RS/RS-RT/RT ..... 28	Doppelstufige RS/RS-RT/RT ..... 28
Motorriduttori ..... 29-32	Geared motors ..... 29-32	Getriemotoren ..... 29-32
<b>Dimensioni</b>	<b>Dimensions</b>	<b>Abmessungen</b>
Motori IEC ..... 33	IEC Motors ..... 33	IEC-Motoren ..... 33
RS ..... 34-35	RS ..... 34-35	RS ..... 34-35
RA ..... 36-37	RA ..... 36-37	RA ..... 36-37
RS/RS ..... 38-39	RS/RS ..... 38-39	RS/RS ..... 38-39
Montaggi alternativi ..... 40-41	Alternative mountings ..... 40-41	Ausführungsvarianten ..... 40-41
Accessori RS ..... 42-43	RS Accessories ..... 42-43	RS-Zubehöre ..... 42-43
RT ..... 44-45	RT ..... 44-45	RT ..... 44-45
TA ..... 46-47	TA ..... 46-47	TA ..... 46-47
RT/RT ..... 48-49	RT/RT ..... 48-49	RT/RT ..... 48-49
Accessori RT ..... 50-51	RT Accessories ..... 50-51	RT-Zubehöre ..... 50-51
XA ..... 52	XA ..... 52	XA ..... 52
<b>Informazioni generali</b>	<b>General information</b>	<b>Allgemeine Informationen</b>
Reversibilità-Irreversibilità ..... 53	Back-driving & Self-locking ..... 53	Umkehrbarkeit u. Selbsthemmung ..... 53
Dati di dentatura ..... 54	Gearing data ..... 54	Verzahnungsdaten ..... 54
Senso di rotazione ..... 55	Direction of rotation ..... 55	Drehrichtungen ..... 55
Uso e Manutenzione ..... 56	Operation and Maintenance ..... 56	Betriebs u. Wartungsanweisung ..... 56

## RS-RT Riduttori - Gearboxes - Getriebe

### Descrizione - Description - Produkte

#### RS, RT - Vite senza fine

I riduttori della serie RS-RT sono costruiti con carcassa e coperchi in alluminio presso fuso fino alla grandezza 85 e in ghisa dalla grandezza 110.

Le coppie indicate nelle tabelle di selezione sono coppie di uscita relative alla grandezza considerata e le potenze sono riferite a 1440 min<sup>-1</sup>.

I paraolio entrata montati su richiesta in Viton per azionamenti con motori a 2 poli o motori c.c. a 3000 min<sup>-1</sup> oppure in Silicone per applicazioni a basse temperature.

I riduttori sono spediti già riempiti con lubrificante sintetico a lunga durata (senza tappi), nelle quantità indicate a pag. 17 e valide per qualunque posizione di funzionamento.

I valori delle tabelle di selezione sono intesi per fattore di servizio FS1.0, vale a dire con funzionamento di 8-10 ore al giorno, con carico uniforme, avviamenti inferiori a 6 all'ora e temperatura ambiente fra 15 e 35 °C.

#### RS, RT - Single-stage worm gear boxes

The worm gearboxes, RS and RT series, specifically designed for universal mounting, are manufactured with die cast housings and covers in aluminium up to size 85 and cast iron from the 110.

Torques listed in selection tables are output torque values and motor powers are always referred to 1440 rpm.

On request, input Viton oil seals allow trouble-free operation with 2-pole standard AC, brushless or 3000 rpm DC motors and Silicone oil seals are recommended for low temperatures.

Gearboxes are delivered filled with synthetic long-life oil (without plugs), see filling quantities at page 17, and valid for all mounting positions.

Selection table data are intended for service factor SF1.0, i.e. 8-10 running hours per day, uniform load, less than 6 start/stops per hour, and room temperature ranging from 15 to 35 °C.

#### RS, RT - Einstufige Schneckengetriebe

Die Getriebe der Serien RS u. RT, eigens für die universelle Montageanordnung entwickelt, haben bis zur Baugröße 85 Gehäuse und Deckel aus Aluminium-Druckguß und aus Guß bei Baugröße 110. Die in den Auswahltabellen genannten Drehmomente sind jeweils die Ausgangsdrehmomente der entsprechenden Baugröße, und die Leistungen beziehen sich auf eine Nenndrehzahl von 1440 1/min. Wellendichtringe aus Viton, auf Anfrage auf der Eingangsseite montiert, ermöglichen einen problemlosen Einsatz von 2-poligen Motoren oder Gleichstrommotoren bis 3000 1/min im Dauerbetrieb. Die Getriebe werden ausgeliefert mit Langzeitschmiermittelfüllung (ohne zusätzliche Verschlussschrauben) und sind für alle Montagepositionen ausreichend befüllt. Die Tabellenwerte berücksichtigen einen Betriebsfaktor von FS 1.0, d.h. Betrieb 8-10 Stunden/Tag, gleichmäßige Belastung, weniger als 6 Schaltvorgängen (Start und Halt) je Stunde und Umgebungstemperaturen zwischen 15 und 35 °C.



#### RA, TA - Vite senza fine con precoppia

I riduttori della serie RA-TA, composti da un riduttore FXA indipendente a una coppia di ingranaggi montato su un riduttore standard del tipo FRS o FRT, forniscono una maggior coppia di uscita ed un più elevato rendimento degli equivalenti rapporti del tipo RS-RT.

#### RS/RS, RT/RT - Vite senza fine doppio stadio

I riduttori della serie RS/RS o RT/RT sono composti di due riduttori della serie RS o RT e forniscono un'ampia scelta di elevati rapporti a completamento della serie RA-TA per ottenere rotazioni alle più basse velocità.

#### RA, TA - Helical worm gear boxes

The helical/worm gearboxes, RA and TA series, made of an independent single stage helical gearbox FXA fitted to a standard FRS or FTR gearbox, allow greater output torques and higher efficiency than the FRS and FRT gearbox with equivalent ratios.

#### RS/RS, RT/RT - Two-stage worm gear boxes

The gearboxes, RS/RS and RT/RT series, are made of two gearboxes RS or RT and offer a full selection of high reduction ratios to obtain low output speeds and high output torques.

#### RS, TA - Schneckengetriebe mit Stirnradvorstufe

Die Getriebe der Serien RA u. TA, bestehen aus einer Kombination eines separaten einstufigen Stirnradgetriebes FXA, mit einem Standard FRS oder FRT Schneckengetriebe und erlauben ein größeres Abtriebsdrehmoment bei besserem Wirkungsgrad als einstufige FRS- u. FRT- Schneckengetriebe mit gleicher Übersetzung.

#### RS/RS, RT/RT - Doppelstufige Schneckengetriebe

Die Getriebe der Serie RS/RS u. RT/RT sind eine Kombination zweier Schneckengetriebe der RS oder RT Baureihe und bieten eine weitgehende Auswahlmöglichkeit an hohen Untersetzungen und somit sehr kleinen Abtriebsdrehzahlen.

# Getriebe - Gearboxes - Riduttori RS-RT

Prodotti - Description - Descrizione

## AS, AD - Albero di uscita

Tutti i tipi di riduttori sono normalmente costruiti con albero uscita cavo e, a richiesta, l'albero lento sporgente in acciaio C43 può essere fornito semplice AS o doppio AD. Su richiesta è disponibile una protezione di sicurezza ASC dell'estremità non utilizzata dell'albero AS.

## BR, BT - Braccio di reazione

I riduttori standard sono forniti normalmente su entrambi i lati con coperchi che permettono il fissaggio del braccio di reazione, quando essi debbono funzionare come riduttori pendolari. Il braccio reazione BR-BT o BRV-BTV (con boccola antivibrante in Vulkollan) è costruito in lamiera ad elevato spessore e zincato bianco.

## TLI/TLE - Limitatore di coppia

Il dispositivo limitatore di coppia - TLI realizzato all'interno del riduttore e TLE installabile esternamente - permette la regolazione della coppia trasmissibile, la protezione del motoriduttore in caso d'ostacolo accidentale, il semplice sblocco del sistema e la manovra manuale in caso di mancanza di corrente. Il valore della coppia di slittamento, tarato in fabbrica, è regolabile in diminuzione dal valore di coppia massima a zero e la rotazione dell'albero di uscita riprende quando la coppia ridiscende al disotto del valore prefissato. Le quantità d'olio del limitatore TLI sono riportate a pagina 42 e 50.

## SL - Limitatore di giri

Il dispositivo SL arresta - per mezzo di fine corsa interni - il funzionamento del motoriduttore dopo un tempo prefissato. La filettatura standard permette circa 40 giri dell'albero di uscita. L'escursione dei fine corsa è regolabile e il tempo di funzionamento varia da 12 a 170 secondi in relazione al rapporto utilizzato.

## Direttiva ATEX

I riduttori VARVEL-ATEX, fornibili su richiesta, sono progettati e costruiti in accordo alla Direttiva 2014/34/UE "Atex" e sono pertanto idonei alla installazione in atmosfere potenzialmente esplosive:

- Zone di Gruppo II,
- Categoria 2 (o 3),
- Pericolo di esplosione in presenza di Gas (Zona 1 o 2),
- Pericolo di esplosione in presenza di Polveri combustibili (Zona 21 o 22).

La serie VARVEL-ATEX viene identificata mediante la marcatura supplementare.

## AS, AD - Output shafts

All gearboxes are manufactured with hollow output shaft as standard. Optionally, a single AS or double AD solid output shaft - made of steel C43 - can be supplied.

An ASC safety shield for the opposite side of a single output shaft AS, is available on demand.

## BR, BT - Torque arms

Standard gearboxes are normally supplied with covers on each side to allow the torque arm fixing when gearboxes have to operate as shaft mounted units.

The torque arm, standard or with Vulkollan vibration damping, is made of extra thick plate and white galvanized.

## TLI/TLE - Torque limiters

The torque limiter and safeguard device - TLI built-in inside the gearbox and TLE fitted outside - allows easy torque adjustments, full gearbox safeguard against unexpected overload conditions, simple hand release, and manual operation in case of power supply failure.

The factory preset slipping torque can be adjusted from the maximum preset torque down to zero. Shaft rotation restarts automatically as soon as torque value is lower than the preset value. Oil quantity of torque limiters TLI are listed on page 42 and 50.

## SL - Travel limiters

The SL travel limiter device stops - by means of built-in limit switches - the gearbox after a given operation time.

Standard thread allows approx. 40 turns of the output shaft. Limit switch travel is adjustable and operation time varies upon the used reduction ratio from min. 12 to max. 170 seconds.

## Directive ATEX

The gearboxes VARVEL-ATEX, supplied on demand, are designed and manufactured according to Directive 2014/34/UE "Atex" and therefore, they are qualified for installation in potentially explosive atmospheres:

- Zones of Group II,
- Category 2 (or 3),
- Explosion hazard with gas presence (Zone 1 or 2),
- Explosion hazard with combustible dust presence (Zone 21 or 22).

The units VARVEL-ATEX are identified by the additional marking.

## AS, AD - Ausgangswelle

Alle Getriebe werden in Hohlwellen-Ausführung hergestellt. Als Zubehör können Einsteckwellen in der Version AS als einseitige Welle oder AD als beidseitige Welle geliefert werden. Diese Einsteckwellen sind aus C43 Stahl gefertigt. Auf Anfrage ist auch ein Wellenschutz ASC als Abdeckung eines Hohlwellenendes lieferbar.

## BR, BT - Drehmomentstütze

Die Getriebe werden normalerweise mit Deckeln auf beiden Abtriebsseiten geliefert, die Bohrungen und Zentrierung für die Befestigung einer Drehmomentstütze besitzen, wenn das Getriebe in der Aufsteckversion eingesetzt wird. Die Drehmomentstütze, Standard oder mit Dämpfungsbuchse aus Vulkollan, ist aus starkem verzinkten Blech hergestellt.

## TLI/TLE-Drehmomentbegrenzer

Die TL Einrichtung ermöglicht die Einstellung der übertragbaren Drehmomente, die Absicherung vom Getriebe gegen Spitzenbelastungen, die einfache Ausschaltung der Antriebseinheit und die manuelle Bedienung im Falle eines Stromausfalles. Das Rutschmoment ist vom max. Einstellmoment bis zum Nullwert einstellbar und die Drehbewegung der Abtriebswelle setzt wieder ein, sobald das Drehmoment wieder kleiner als das eingestellte Moment wird. Ölmenge: Seite 42 u. 50.

## SL - Drehzahlbegrenzer

Die SL-Einrichtung stoppt, mittels eingebauten Wegschalter, das Getriebe nach einer bestimmten Zeit. Die Standardgewindespindel, ermöglicht ca. 40 Umdrehungen der Ausgangswelle. Die Wegschalter sind einstellbar und die Betriebszeit ist, abhängig von der Untersetzung, zwischen min. 12" bis max. 170".

## ATEX Richtlinien

Die Getriebe Varvel-Atex, ausschließlich auf Anfrage geliefert, sind entsprechend den ATEX-Richtlinien 2014/34/UE "ATEX" konstruiert und hergestellt und somit zugelassen für die Installation in potentiell zündfähigen Atmosphäre:

- Gefahrenbereiche der Gruppe II
- Kategorie 2 (oder 3)
- Explosionsgefährdeter Bereich mit Gase (Gefahrenbereiche 1 oder 2)
- Explosionsgefährdeter Bereich mit zündfähigen Stäube (Gefahrenbereiche 21 oder 22).

Die Varvel-Atex Produkte sind mit folgenden zusätzlichen Stempelung versehen.

 II 2 GD ck IP66 T<sub>max</sub>=135 °C

## RS-RT Riduttori - Gearboxes - Getriebe

### Descrizione - Description - Produkte



	SPECIFICHE GENERALI	GENERAL SPECIFICATIONS	ALLGEMEINE EIGENSCHAFTEN
Gamma Range Bereich	Grandezze : 9 RS + 7 RT 55 rapporti di riduzione 3020 Nm coppia uscita max	Sizes: 9 RS + 7 RT 55 reduction ratios 3020 Nm max. output torque	Baugrößen: 9 RS + 7 RT 55 Übersetzungen 3020 Nm max. Abtriebsmoment
Dimensionamento Sizing Auslegung	Secondo BS721. Vita media 15.000 ore con fattore di servizio SF1	According to BS721. 15,000 hrs average lifetime with service factor SF1	Entsprechend BS721 15T Stunden Lebensdauer für Verzahnung und Lagerung bei einem Bfaktor SF1
Carcassa, Coperchi Housing, Covers Gehäuse, Flansche	Pressofusione in alluminio fino grandezza 85 e ghisa dalla grandezza 110.	Pressure die cast aluminium till size 85 and cast iron from size 110.	Aluminium-Druckguss bis Größe 85 und G25 vom Größe 110.
Entrata con giunto G Coupling G input Kupplungseingang G	Pressofusione in alluminio	Pressure die cast aluminium	Aluminium-Druckguss
Parti dentate Toothed parts Verzahnung	Viti in acciaio cmt / tmp con profilo rettificato. Ruote in bronzo su mozzo in ghisa.	Worms of steel CH and tooth profile ground. Wheels of bronze on cast iron hub.	Stahl einsatzgehärtet. Zahnprofil geschliffen. Schnecken-rad in Bronze HW Roheisen
Alberi & Linguette Shafts & Keys Wellen u. Passfedern	Acciaio Alberi h6 - Fori E8 Linguette secondo DIN6885 B1	Steel Shafts h6 - Bores E8 Keys according to DIN6885 B1	Stahl Wellen h6 – Bohrungen E8 Passfedern nach DIN6885 B1
Albero uscita cavo Hollow output shaft Abtriebshohlwelle	Acciaio, ghisa grigia o sferoidale secondo grandezza riduttore	Steel, gray or ferritic cast iron according to gearbox size	Stahl, Grauguß oder GGG nach Getriebegröße
Cuscinetti Bearings Lagerung	Sfere o rulli secondo grandezza e specifiche tecniche	Ball- or roller-types according to sizes and technical requirements	Kugel- oder Rollenlager entsprechend den technischen Vorschriften
Paraolio Oil seals Dichtungen	Tipo NBR - nitril-butadiene con secondo labbro parapolvere secondo DIN 3760	Type NBR - nitril-butadiene with additional anti-dust lip according to DIN 3760	Typ NBR – Nitril-Butadien mit zusätzlicher Staublippe entsprechend DIN 3760
Lubrificante Lubricant Schmierung	Olio sintetico a lunga durata Gradazione ISO VG 320	Synthetic long-life oil Grade ISO VG 320	Synthetisches Getriebeöl ISO VG 320 als Langzeit-Füllung
Verniciatura Coating Lackierung	RS/RT ≥110: vernice a polveri epossidiche, RAL 7012. RS/RT28-85: alluminio.	RS/RT ≥110: epoxy powder paint, std colour RAL 7012. RS/RT28-85: real aluminium.	RS/RT ≥110: Epoxypulverfarbe Standardfarbton RAL 7012 RS/RT28-85: Aluminium.
Grado di Protezione Protection Grade Schutzklasse	Corpo riduttore IP66. Flange motore e collegamenti IP20; aumentata a richiesta.	Gearbox body IP66. Motor and connection flanges IP20; increased protection on demand.	Getriebekörper IP66. Motor- und Verbindungs-Flansche IP20; erhöhter Schutz auf Anfrage

## Getriebe - Gearboxes - Riduttori RS-RT

### Simboli - Symbols - Abkürzungen

Simbolo Symbol Abkürzung	Descrizione	Description	Beschreibung
$F_r$ [N]	Carico radiale dell'applicazione	Application radial load	Radialkraft der Anwendung
$F_{r1}$ [N]	Carico radiale di catalogo (entrata)	Catalogue radial load (input)	Radialkraft aus dem Katalog (Eingang).
$F_{r2}$ [N]	Carico radiale di catalogo (uscita)	Catalogue radial load (output)	Radialkraft aus dem Katalog (Ausgang).
FS	Fattore di servizio Service factor Betriebsfaktor	$FS = \frac{M_2}{M_{(app)}}$	
$i_n$	Rapporto di riduzione nominale	Nominal reduction ratio	Nominelle Übersetzung
$i$	Rapporto di riduzione reale	Actual reduction ratio	Wirklich Übersetzung
Lub [l]	Lubrificante (litri)	Lubricant (litres)	Schmierstoff (Liter)
$J_1$ [kgm <sup>2</sup> ]	Momento di inerzia del riduttore all'albero di entrata	Moment of inertia of the gearbox at input shaft	Trägheitsmoment des Getriebe an der Eingangswelle
$M_2$ [Nm]	Coppia massima di uscita del riduttore	Gearbox maximum output torque	Abtriebsdrehmoment des Getriebes
$M_{(app)}$ [Nm]	Coppia dell'applicazione	Application torque	Erforderliches Drehmoment der Anwendung
$n_1$ [min <sup>-1</sup> ]	Velocità di entrata	Input speed	Eingangsdrehzahl
$n_2$ [min <sup>-1</sup> ]	Velocità di uscita	Output speed	Ausgangsdrehzahl
$P_1$ [kW]	Potenza in entrata Input power Motorleistung	$P_1 = \frac{M_2 * n_2}{9550 * \eta}$	
$P_{(kg)}$ [kg]	Peso	Weight	Gewicht
$\eta$	Rendimento	Efficiency	Wirkungsgrad

# RS-RT Riduttori - Gearboxes - Getriebe

Sistema modulare - Modular System - Modularesystem

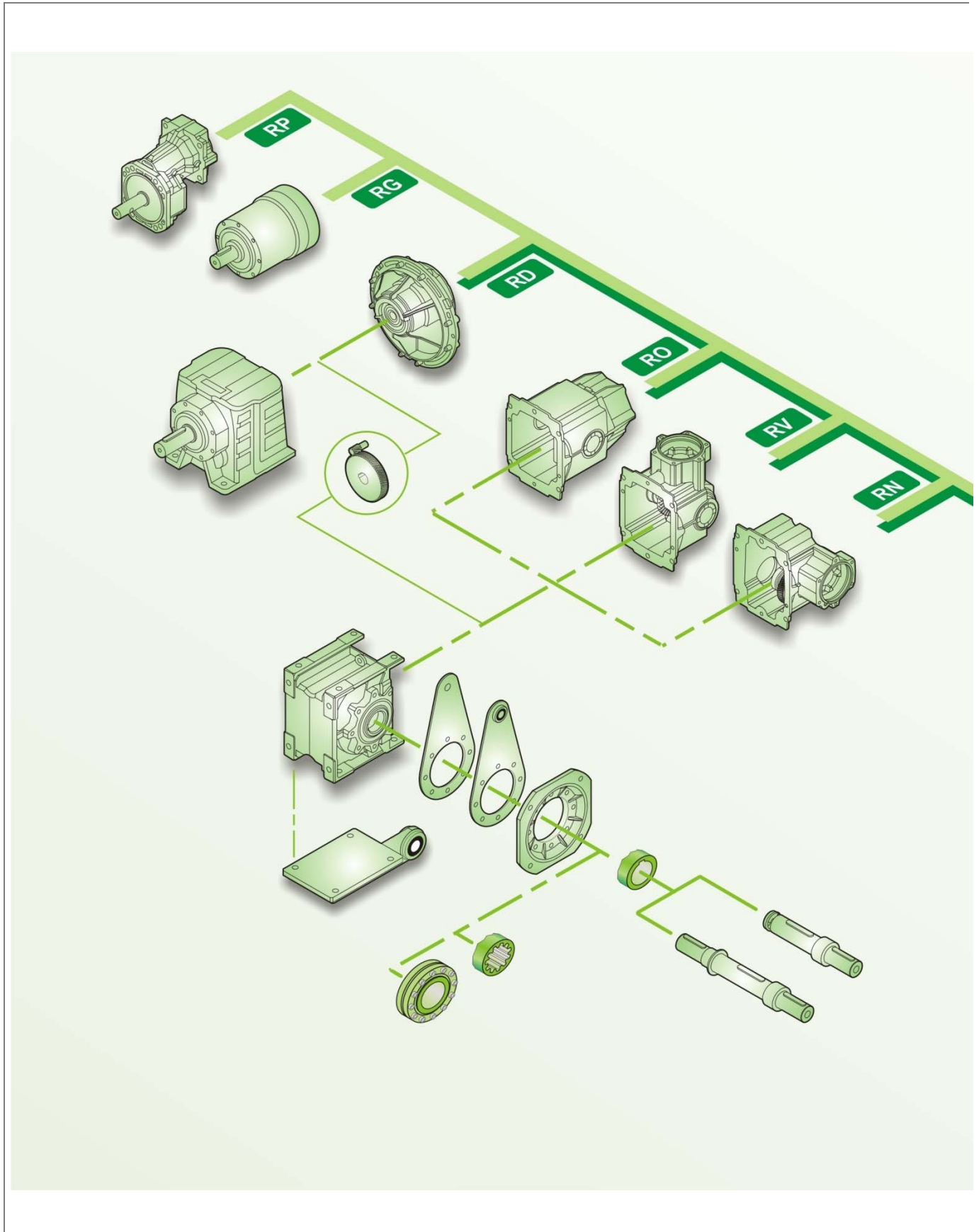



# Getriebe - Gearboxes - Riduttori RS-RT

Modularsystem - Modular System - Sistema modulare

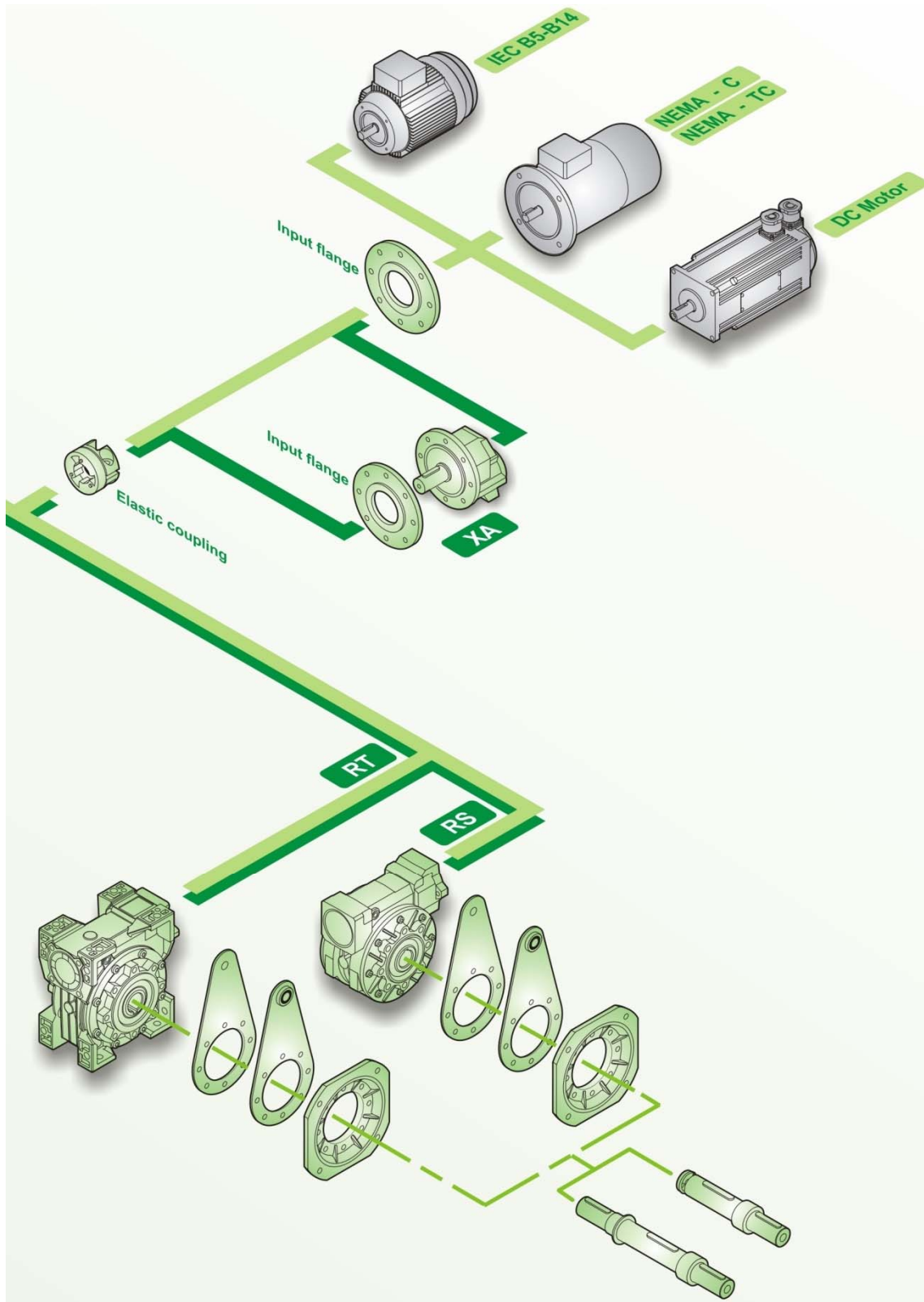

# RS-RT Riduttori - Gearboxes - Getriebe

## Descrizione Giunto "G" - Coupling "G" Description - Kupplung "G" Beschreibung

- **Semi-giunto riduttore**
  - Materiale: acciaio
  - Integrale con albero entrata
  - Supportato con due cuscinetti
  - Dimensioni lato entrata invariate
- **Anello elastico**
  - Denti: collegati esternamente
  - Materiale: Elastomero Termoplastico Ixef<sup>®</sup> - Polirilamide
  - Durezza 90 Shore D
  - Temperatura -30/+135° C (-22/+275°F)
- **Semi-giunto motore**
  - Materiale: Alluminio pressofuso (G3, G5, G6) Acciaio (GS8) Acciaio su richiesta (GS3, GS5, GS6)
  - Bilanciatura dinamica
  - Calettamento: Morsetto (G3, G5, G6) Chiavetta (GS3, GS5, GS6)
  - Fori disponibili secondo: IEC 72 / DIN42948 NEMA C e TC
- **Vantaggi:**
  - Un solo riduttore per rapporto di riduzione
  - Maggiore flessibilità
  - Aumentata rotazione dello stock
  - Eliminazione sfregamento fra chiavetta e cava (tribocorrosione)
  - Collegamento riduttore / motore con gioco zero
  - Disallineamento angolare ammesso <1°
  - Elevata rigidità torsionale
  - Elevato smorzamento delle vibrazioni
- **Flange entrata:**
  - Materiale: Alluminio fino IEC112 e NEMA TC180 Ghisa da IEC 132 e NEMA TC200

- **Reducer Half-coupling**
  - Material: steel
  - One piece machined on Input shaft
  - Two bearing setting
  - Unchanged casing dimensions
- **Spider**
  - External tooth connection
  - Material: Thermoplastic Elastomer: Ixef<sup>®</sup> - Plyarilamide
  - Hardness 90 Shore D
  - Temperature -30/+135°C (-22/+275°F)
- **Motor Half-coupling**
  - Material: Alu pressure die cast (G3, G5, G6) Steel (GS8) Steel on demand (GS3, GS5, GS6)
  - Dynamic balancing
  - Fitting: Clamp (G3, G5, G6) Key (GS3, GS5, GS6)
  - Bores, available according to: IEC 72 / DIN42948 NEMA C and TC
- **Advantages:**
  - One gearbox only for each reduction ratio
  - Greater flexibility
  - Increased stock rotation
  - Elimination of fretting corrosion between key and keyway
  - Gearbox / motor connection with zero backlash
  - Allowed angular misalignment 1° max.
  - High torsional rigidity
  - High vibration damping
- **Input flanges:**
  - Material: Aluminium up to IEC112 & NEMA TC180 Cast iron from IEC 132 & NEMA TC200

- **Getriebekupplungshäfte**
  - Material: Stahl
  - integrierte Eingangswelle
  - Zwei-Lager-Anordnung
  - unveränderte Eingang Abmessungen
- **Kupplungsscheibe**
  - Außerliche Zahnverbindung
  - Material Thermoplastische Elastomer: Ixef<sup>®</sup> - Polyirilamide
  - Härte 90Shore D
  - Temperatur -30/+135° C (-22/+275°F)
- **Motorkupplungshäfte**
  - Material: Aluminium Druckguss (G3, G5, G6) Stahl (GS8) Stahl aus Anfrage (GS3, GS5, GS6)
  - dynamische Auswuchtung
  - Verkeilung: Klammer (G3, G5, G6) Keil (GS3, GS5, GS6)
  - Bohrungen, nach: IEC 72 / DIN42948 NEMA C u. TC
- **Vorzüge:**
  - nur eine Getriebekomponente je Übersetzung
  - gesteigerte Flexibilität
  - höher Lagerumschlag
  - Vermeidung von Passungsost zwischen Keil u. Keil Einschnitt
  - Getriebe / Motor Spielfrei Verkeilung
  - erlaubt Winkelausgleich bis 1°
  - hohe Verdrehsteifigkeit
  - hohe Dämpfung vonSchwingungen
- **Eingangsflansche:**
  - Material: Aluminium bis IEC112 u. NEMA C180 Grauguss IEC 132 u. NEMA C200

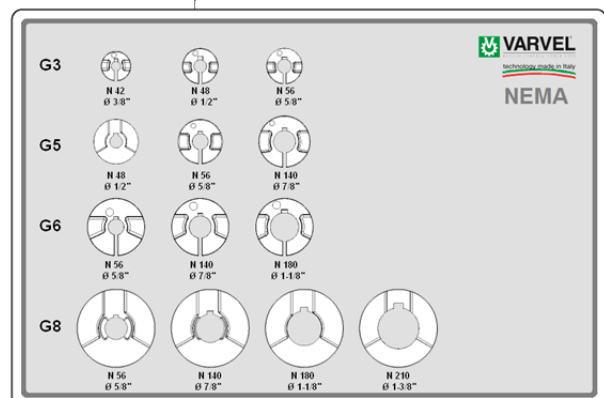
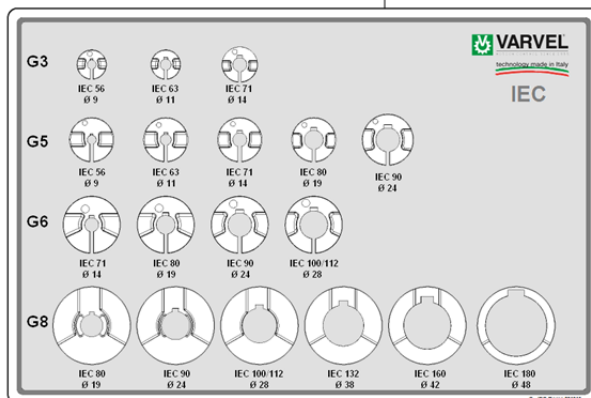

## Getriebe - Gearboxes - Riduttori RS-RT

### Kupplungsauswahl "G" - Elastic Coupling Selection "G" - Selezione Giunto "G"

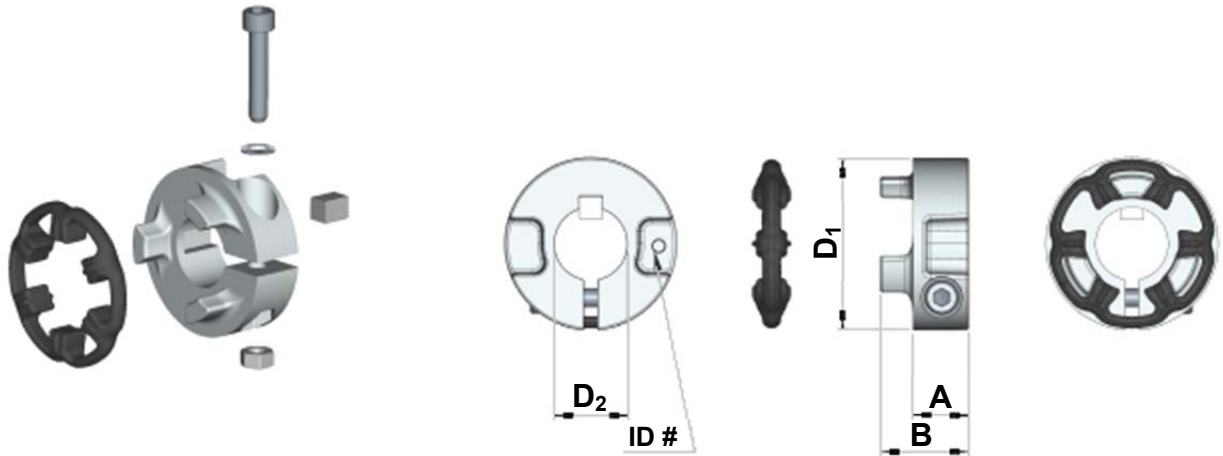

Giunto Coupling Kupplung	IEC NEMA	Codice Kit Kit Code	RS - RT	Mt [Nm]	Mt <sub>1</sub> [Nm]	Mt <sub>2</sub> [Nm]	A [mm]	B [mm]	D1 [mm]	D <sub>2</sub> [mm/inch]	ID#
G3	IEC	KG3.009	28-40	4.5 - 6	15	8-10	11	19	30	9	309
		KG3.011	28-40	4.5 - 6	15	8-10			30	11	311
		KG3.014	40	7 - 8.5	28	18-22			36	14	314
	NEMA	KG3.N42	28-40	4.5 - 6	16	8-10			30	3/8"	3N42
		KG3.N48	40	4.5 - 6	18	10-12			36	1/2"	3N48
		KG3.N56	40	7 - 8.5	30	20-24			36	5/8"	3N56
G5	IEC	KG5.011	50-60	8.9 - 10	15	8-10	14.5	23	45	11	511
		KG5.014	50-60		30	12-17			45	14	514
		KG5.019	50-60		40	20-25			45	19	519
		KG5.024	60		70	30-40			52	24	524
	NEMA	KG5.N56	50-60		45	30-35			45	5/8"	5N56
		KG5.N140	60		60	40-45			52	7/8"	5N140
G6	IEC	KG6.014	70	15.3 - 18	60	30-40	19.5	31.5	58	14	614
		KG6.019	70-85-110		90	50-65				19	619
		KG6.024	70-85-110		130	85-100				24	624
		KG6.028	70-85-110		180	100-120				28	628
	NEMA	KG6.N56	70-85-110		50	---				5/8"	6N56
		KG6.N140	70-85-110		85	---				7/8"	6N140
KG6.N180	70-85-110	200	---	1-1/8"	6N180						

Mt - Coppia serraggio vite

Mt<sub>1</sub> - Coppia trasmissibile con chiavetta

Mt<sub>2</sub> - Coppia trasmissibile senza chiavetta

Mt - Screw locking torque

Mt<sub>1</sub> - Transmissible torque with key

Mt<sub>2</sub> - Transmissible torque without key

Mt - Schraubenklemmendrehmoment

Mt<sub>1</sub> - übertragbar Drehmoment mit Keil

Mt<sub>2</sub> - übertragbar Drehmoment ohne Keil

## RS-RT Riduttori - Gearboxes - Getriebe

### IEC - Selezione Flangia - Flange Selection - Flanschauswahl

RS - RT - XA	Flangia Flange Flansch	IEC	Codice Kit / Kit Code		Giunto - Coupling - Kupplung	
			Flange B5	Flange B14	Tipo - Type - Typ	Kit Code
RS-RT 28	FM 28	IEC56 IEC63	K530.206.120 K530.206.140	K530.206.080 K530.206.090	G3 ø9 G3 ø11	KG3.009 KG3.011
RS-RT 40	FM 40	IEC56 IEC63 IEC71	K531.206.120 K531.206.140 K531.206.160	K531.206.080 K531.206.090 K531.206.105	G3 ø9 G3 ø11 G3 ø14	KG3.009 KG3.011 KG3.014
RS-RT 50	FM 50	IEC63 IEC71 IEC80	K532.206.140 K532.206.160 K532.206.200	K532.206.090 K532.206.105 K532.206.120	G5 ø11 G5 ø14 G5 ø19	KG5.011 KG5.014 KG5.019
RS-RT 60	FM 60	IEC71 IEC80 IEC90	K539.206.160 K539.206.200 K539.206.200	K539.206.105 K539.206.120 K539.206.140	G5 ø14 G5 ø19 G5 ø24	KG5.014 KG5.019 KG5.024
RS-RT 70	FM 70	IEC71 IEC80 IEC90 IEC100	K533.206.160 K533.206.200 K533.206.200 K533.206.250	K533.206.105 K533.206.120 K533.206.140 K533.206.160	G6 ø14 G6 ø19 G6 ø24 G6 ø28	KG6.014 KG6.019 KG6.024 KG6.028
RS-RT 85	FM 85	IEC80 IEC90 IEC100/112	K534.206.200 K534.206.200 K534.206.250	K534.206.120 K534.206.140 K534.206.160	G6 ø19 G6 ø24 G6 ø28	KG6.019 KG6.024 KG6.028
RS-RT 110	FM 110	IEC90 IEC100/112 IEC132	K535.206.200 K535.206.250 K535.206.300	--- K535.206.160 K535.206.200	G6 ø24 G6 ø28 # ø38	KG6.024 KG6.028 ---
RS 130	FM 130	IEC100/112 IEC 132	K536.206.250 K537.206.300	--- K536.206.200	# ø28 # ø38	--- ---
RS 150	FM 150	IEC100/112 IEC 132 IEC 160	K536.206.250 K537.206.300 K537.206.350	K536.206.200 K536.206.250 ---	# ø28 # ø38 # ø42	--- --- ---
XA 63	FM 40	IEC56 IEC63	K531.206.120 K531.206.140	K531.206.080 K531.206.090	# ø9 # ø11	--- ---
XA 71	FM 50	IEC71	K532.206.160	K532.206.105	# ø14	---
XA 80	FM 70	IEC80 IEC90	K533.206.200 K533.206.200	K533.206.120 K533.206.140	# ø19 # ø24	--- ---
XA 100	FM 85	IEC80 IEC90 IEC100/112	K534.206.200 K534.206.200 K534.206.250	K534.206.120 K534.206.140 K534.206.160	G6 ø19 G6 ø24 G6 ø28	KG6.019 KG6.024 KG6.028

# - Accoppiamento motore con chiavetta

# - Key/keyway motor fitting

# - Motormontage mit Keil/Keilriemen

## Getriebe - Gearboxes - Riduttori RS-RT

Flanschwahl - Flange Selection - Selezione Flangia - NEMA

RS - RT	Flangia Flange Flansch	NEMA	Codice Kit / Kit Code  Flange	Giunto - Coupling - Kupplung	
				Tipo - Type - Typ	Kit Code
RS-RT 28	FM 28	42 C 48 C	K530.207.N048 K530.207.N048	G3 ø 3/8" G3 ø 1/2"	KG3.N042 KG3.N048
RS-RT 40	FM 40	42 C 48 C 56 C	K531.227.N048 K531.227.N048 K531.227.N056	G3 ø 3/8" G3 ø 1/2" G3 ø 5/8"	KG3.N042 KG3.N048 KG3.N056
RS-RT 50	FM 50	56 C	K532.227.N056	G5 ø 5/8"	KG5.N056
RS-RT 60	FM 60	56 C 140 TC	K539.227.N056 K539.227.N056	G5 ø 5/8" G5 ø 7/8"	KG5.N056 KG5.N140
RS-RT 70	FM 70	56 C 140 TC 180 TC	K533.227.N056 K533.227.N056 K533.227.N180	G6 ø 5/8" G6 ø 7/8" G6 ø 1-1/8"	KG6.N056 KG6.N140 KG6.N180
RS-RT 85	FM 85	56 C 140 TC 180 TC	K534.227.N056 K534.227.N056 K534.227.N180	G6 ø 5/8" G6 ø 7/8" G6 ø 1-1/8"	KG6.N056 KG6.N140 KG6.N180
RS-RT 110	FM 110	56 C 140 TC 180 TC	K535.227.N056 K535.227.N056 K535.227.N180	G6 ø 5/8" G6 ø 7/8" G6 ø 1-1/8"	KG6.N056 KG6.N140 KG6.N180
RS 130	FM 130	56 C 140 TC 180 TC	K536.227.N056 K536.227.N056 K536.227.N180	# ø 5/8" # ø 7/8" # ø 1-1/8"	--- --- ---
RS 150	FM 130	56 C 140 TC 180 TC 210 TC	K537.227.N056 K537.227.N056 K537.227.N180 K537.227.N180	# ø 5/8" # ø 7/8" # ø 1-1/8" # ø 1-1/8"	--- --- --- ---
XA 63	FM 40	* IEC56 * IEC63	K531.206.120 K531.206.140	# ø9 mm # ø11 mm	--- ---
XA 71	FM 50	* IEC71	K532.206.160	# ø14 mm	---
XA 80	FM 70	* IEC80 * IEC90	K533.206.200 K533.206.200	# ø19 mm # ø24 mm	--- ---
XA 100	FM 85	56 C 140 TC 180 TC	K334.227.N056 K334.227.N056 K334.227.N180	G6 ø 5/8" G6 ø 7/8" G6 ø 1-1/8"	KG6.N056 KG6.N140 KG6.N180

# - Accoppiamento motore con chiavetta

\* - Entrata solo IEC

# - Key/keyway motor fitting

\* - IEC input only

# - Motormontage mit Keil/Keilriemen

\* - Nur IEC-Eingang

# RS-RT Riduttori - Gearboxes - Getriebe

## Designazione Riduttore e Motore - Gearbox & Motor Designation - Getriebe- u. Motorbezeichnungen

### DESIGNAZIONE DEL RIDUTTORE

### GEARBOX DESIGNATION

### BEZEICHNUNG GETRIEBE

**F RT - G [./] 40 B3 28 IEC71 B14 (OPS, OPP)**

OPS= Opzioni standard pag.42 e 50 - *Standard options pages*

42 & 50 - Standard Optionen Seite 42 u. 50

OPP= Opzioni piè pagina – *Options listed at the foot of the page* -

Optionen siehe Seitenende

B5, B14 = Forma motore - *Motor form* - Motorbauform

Grandezza motore elettrico - *Electric motor frame* - Motorbaugröße

Rapporto di riduzione - *Reduction ratio* - Untersetzungsverhältnis

Forma costruttiva - *Mounting form* - Einbaulage

28, 40, 50, 60, 70, 85, 110, 130, 150 = Grandezza riduttore - *Gearbox size* - Baugröße

63/, 71/, 80/ (RX) = Grandezza precoppia - *Helical stage size* - Baugröße Vorstufe

28/, 40/, 50/ = Grandezza 1° riduttore - *1st gearbox size* - Baugröße Getriebe 1.

Con giunto G / Cava & chiavetta - *With Coupling G / Keyway & key* - mit Kupplung G / Keil Einschnitt u. Keil

RS, RA, RS/RS, RT, TA, RT/RT = Tipo riduttore - *Gearbox type* - Getriebetyp

M = Motoriduttore - *Geared motor* - Getriebemotor

F = Con flangia entrata - *With input flange* - mit Eingangsflansch

S = Senza flangia entrata - *Without input flange* - ohne Eingangsflansch

... = Albero entrata - *Free input shaft* - freie Eingangswelle

### DESIGNAZIONE DEL MOTORE

### MOTOR DESIGNATION

### BEZEICHNUNG MOTOR

**MT 0.37kW 71B 4 B14 230/400/50 IP55 F X1**

Posizione morsetti - *Terminal box position* - Klemmenkastenlage

Cl. F (std) = Classe isolamento - *Insulation class* - Isolationsklasse

IP55 (std) = Grado protezione - *Protection class* - Schutzart

Tensione/frequenza - *Voltage/frequency* - Spannung/Frequenz

Forma costruttiva - *Mounting* - Bauform

Numero poli - *Number of poles* - Polzahl

Grandezza IEC motore - *IEC motor size* - Baugröße Motor

Potenza motore - *Motor power* - Leistung Motor

MT = Motore trifase - *Three-phase motor* - Dreiphasen-Motor

MM= Motore monofase - *Single-phase motor* - Einphasen-Motor

MA = Motore autofrenante - *Brake motor* - Bremsmotor

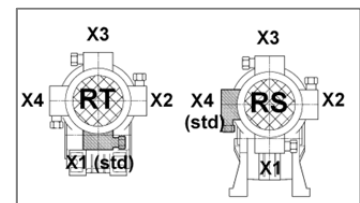

### OPZIONI OPP

L'allestimento standard, ove non diversamente richiesto, è montato sul lato destro visto dall'entrata.

ACØ - Albero cavo non std Ø..  
CS - Cuscinetti uscita non std  
F, FL - Flangia uscita aggiuntiva  
GRM - Gioco ridotto montaggio  
LNS - Lubrificazione non std  
VB - Vite bisporgente

### OPTIONS OPP

Standard fitting side, unless otherwise requested, is the right side of the gearbox when seen from the input side.

ACØ - Non-standard hollow shaft Ø..  
CS - Heavy duty output bearings  
F, FL - Additional output flange  
GRM - Reduced end play  
LNS - Non-standard lubrication  
VB - NDE wormshaft extension

### OPTIONEN OPP

Die Standardausführung, wenn nicht gesondert angefragt, wird auf die rechte Seite, vom Eingang her betrachtet, montiert.

ACØ - Sonderhohlwelle Ø..  
CS - Sonderlager Ausgang  
F, FL - zusätzlicher FL Ausgangsflansch  
GRM - spielarme Montage  
LNS - Sonderschmierung  
VB - Schneckenwelle beidseitig

# Getriebe - Gearboxes - Riduttori RS-RT

Elektronischer Katalog - Electronic Catalogue - Catalogo elettronico



## Modularità e flessibilità

hanno guidato la progettazione dei prodotti Varvel dagli anni 2000: così, la disponibilità di riduttori in kit ha permesso il montaggio in pochi minuti e con una normale attrezzatura.

Ciò permette la massima flessibilità ai distributori e rivenditori Varvel che, grazie ad un assortimento limitato di kit, possono configurare all'istante il prodotto richiesto dal loro cliente.

Il programma di selezione **VARsize®** disponibile sul sito

[www.varvel.com](http://www.varvel.com)

permette un agevole dimensionamento dei prodotti Varvel.

## Modelli 2D/3D

Tramite configurazione assistita vengono generati i modelli 3D/disegni 2D nei formati CAD più diffusi.

## Selezione guidata

Individua, fra tutte le serie, i riduttori idonei a soddisfare i parametri delle prestazioni richieste (potenza, coppia, numero giri, fattore di applicazione, ecc.). Definita la grandezza del riduttore è generato un documento con i dati prestazionali ed il disegno dimensionale quotato, così come il modello 3D e il disegno 2D.

## Modularity and flexibility

have been leading the design of Varvel products since 2000. The gearbox-kit concept was carried out allowing anyone to assemble the unit in a few minutes with standard tooling.

This feature provides the highest flexibility to Varvel's distributors and resellers who - thanks to a limited kit selection - are able to immediately configure the required product.

**VARsize®** selection program, available from our site

[www.varvel.com](http://www.varvel.com)

allows easy sizing selection from the Varvel product range.

## 2D/3D Drawings

A guided selection allows 2D/3D models to be downloaded for the most popular CAD systems.

## Guided selection

The suitable product configuration returns upon a given sequence of application parameters (power, output torque, rpm, service factor, etc.) a PDF data sheet including performance data, and 2D dimensional drawings are generated accordingly. A 3D model is also available as alternative output.

## Bausteinprinzip und Flexibilität

bestimmen die Gestaltung der Varvel Produkte seit 2000. Dieses Konzept ermöglicht jedermann in kurzer Zeit mit Standardwerkzeugen das gewünschte Getriebe zu montieren. Damit wird allen Verkäufern von Varvelantrieben ein Höchstmaß an Flexibilität gegeben, um mit wenigen Bauteilen ein gewünschtes Getriebe zu konfigurieren.

**VARsize®** als Auswahlprogramm auf unserer Internetseite

[www.varvel.com](http://www.varvel.com)

bietet eine angepasste Antriebsauslegung.

## 2D/3D Drawings

Die unterstützte Auswahl bietet die Möglichkeit 2D/3D Modelle für die gängigen CAD Systeme zu laden.

## Unterstützte Auswahl

Mit diesem Dienst wird eine Liste möglicher Produktvarianten erzeugt, bestimmt durch Parameter (Leistung, Moment, Drehzahl, Betriebsfaktor usw.); ein PDF Datenblatt mit Leistungsdaten und Maßbild ist für jede dieser Konfigurationen verfügbar, ebenso wie 3D Modelle and 2D Zeichnungen.

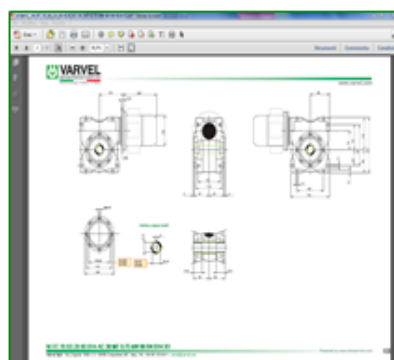
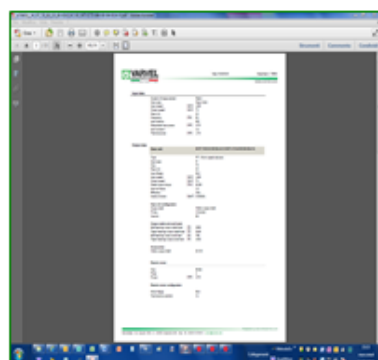







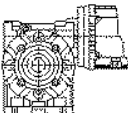
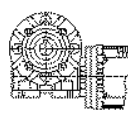
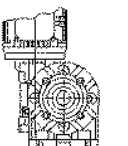
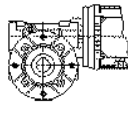
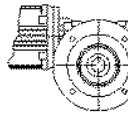
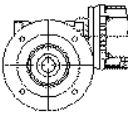
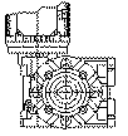
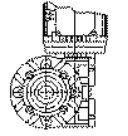
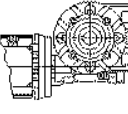
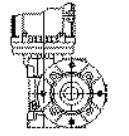
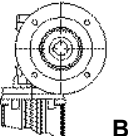
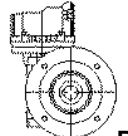
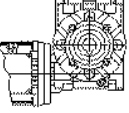
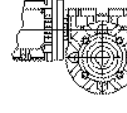
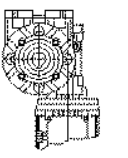
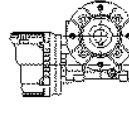
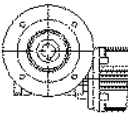
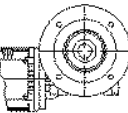
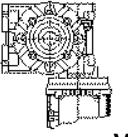
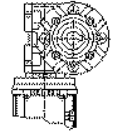
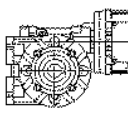
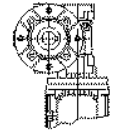
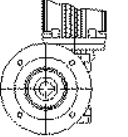
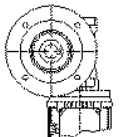
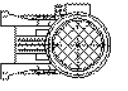

# RS-RT Riduttori - Gearboxes - Getriebe

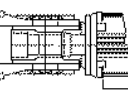
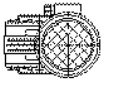
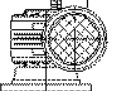
Posizioni di montaggio - Standard mounting positions - Montageposition



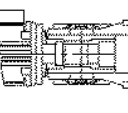

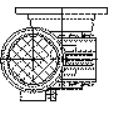
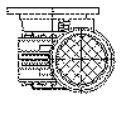

## RS , RA , RS/RS

Uscita - Output - Ausgang

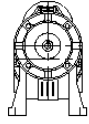
S ( SA )	I ( IA )	D ( DA )	PC - PC	FL ( FA,FB ) & ( PA,PB )	
<b>B3 (std)</b> 	 <b>B3 (std)</b>	 <b>B3 (std)</b>	 <b>B5 (std)</b>	 <b>B5 (std)</b>	 <b>B5i</b>
 <b>V5</b>	 <b>V5</b>	 <b>V5</b>	 <b>B5</b>	 <b>B5a</b>	 <b>B5ai</b>
 <b>B8</b>	 <b>B8</b>	 <b>B8</b>	 <b>B5</b>	 <b>B5b</b>	 <b>B5bi</b>
 <b>V6</b>	 <b>V6</b>	 <b>V6</b>	 <b>B5</b>	 <b>B5c</b>	 <b>B5ci</b>
 <b>B6</b>	 <b>B6</b>	 <b>B6</b>	 <b>V1</b>	 <b>V1</b>	 <b>V1i</b>
 <b>B7</b>	 <b>B7</b>	 <b>B7</b>	 <b>V3</b>	 <b>V3</b>	 <b>V3i</b>

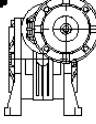
## RA

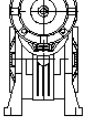
Entrata - Input - Eingang

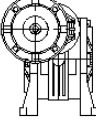
10 (Std)	11	12	13		
 	 	 	 		



# Getriebe - Gearboxes - Riduttori RS-RT

Montageposition - Standard mounting positions - Posizioni di montaggio

## RS/RS

Uscita - Output - Ausgang

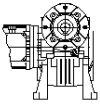
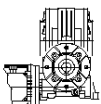
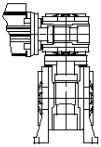
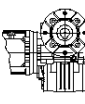
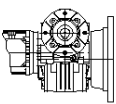
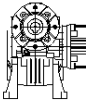
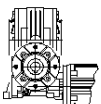
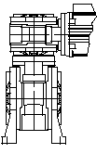
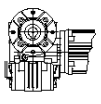
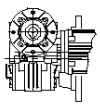
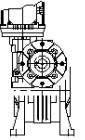
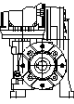
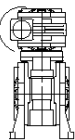
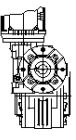
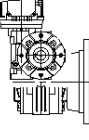
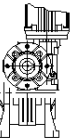
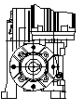
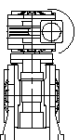
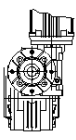
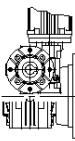
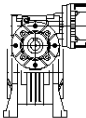
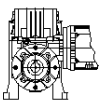
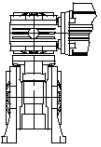
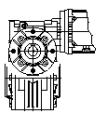
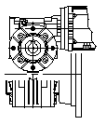
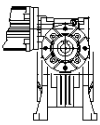
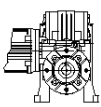
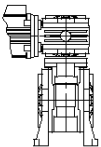
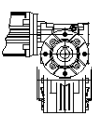
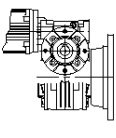
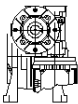
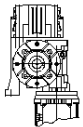
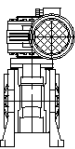
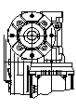
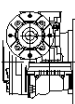
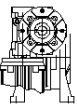
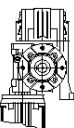
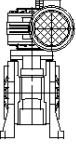
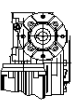
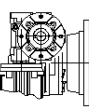
	S ( SA )	I ( IA )	D ( DA )	PC ( PA, PB )	FL ( FA, FB )
11					
12					
13					
14					
15					
16					
17					
18					

## RS-RT Riduttori - Gearboxes - Getriebe

Posizioni di montaggio - Standard mounting positions - Montageposition

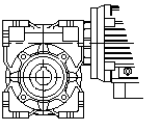
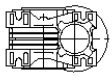
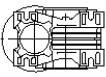
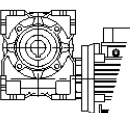
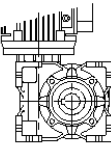
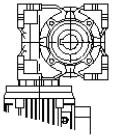
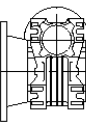
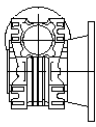
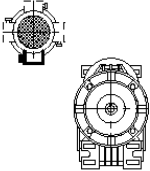
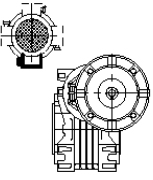
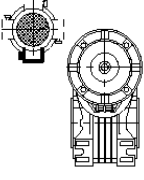
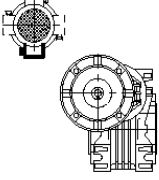
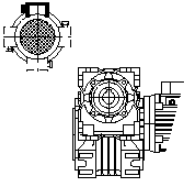
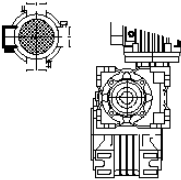
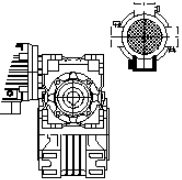
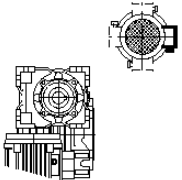
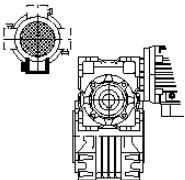
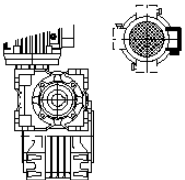
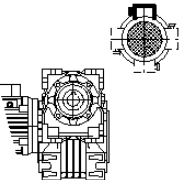
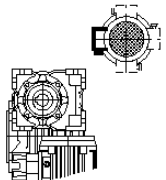
<b>RT</b> <b>TA</b> <b>RT/RT</b> Uscita Output Ausgang	 <p>B3 (std)</p>	 <p>B6</p>	 <p>B7</p>	 <p>B8</p>
	 <p>V5</p>	 <p>V6</p>	 <p>F (std)</p>	 <p>Fi</p>
<b>TA</b> Entrata Input Eingang	 <p>10 (std)</p>	 <p>11</p>	 <p>12</p>	 <p>13</p>
<b>RT/RT</b> Entrata Input Eingang	 <p>20 (std)</p>	 <p>21</p>	 <p>22</p>	 <p>23</p>
	 <p>24</p>	 <p>25</p>	 <p>26</p>	 <p>27</p>

# Getriebe - Gearboxes - Riduttori RS-RT

Betriebsfaktoren - Service factors - Fattori di servizio

- FATTORI DI SERVIZIO
- SERVICE FACTORS
- BETRIEBSFAKTOREN

$$FS = FS_1 \times FS_2$$

h	FS <sub>1</sub>			FS <sub>2</sub>	
	a	b	c	a/h	d
3 - 4 h	0.8	1.0	1.5	6 a/h	1.0
8 - 10 h	1.0	1.2	1.8	60 a/h	1.2
10 - 24 h	1.4	1.6	2.0	120 a/h	1.4

- a = Carico uniforme / Uniform load / gleichmäßige Belastung
- b = Carico variabile / Variable load / variable Belastung
- c = Carico ad urti / Shock load / Stoßbelastung
- d = Avviamenti/ora / Start/stops per hour / Schaltungen/Stunde

- PESI & LUBRIFICANTI (litri)
- WEIGHTS & LUBRICANTS (litres)
- GEWICHT u. SCHMIERMITTEL (liter)

RS - RT	kg	l	RA - TA	kg	l <sub>1/2</sub>	RS / RS RT / RT	kg	l <sub>1/2</sub>
28	1.1	0.03	63 / 40	4.0	0.04/0.08	28 / 28	2.5	0.03/0.03
40	2.5	0.08	63 / 50	5.3	0.04/0.13	28 / 40	3.9	0.03/0.08
50	3.8	0.13	63 / 60	8.0	0.04/0.25	28 / 50	5.2	0.03/0.13
60	6.5	0.25	71 / 50	6.6	0.05/0.13	28 / 60	7.9	0.03/0.25
70	9.0	0.35	71 / 60	9.3	0.05/0.25	40 / 70	12.0	0.08/0.35
85	13.5	0.60	71 / 70	11.8	0.05/0.35	40 / 85	16.5	0.08/0.60
110	39.0	1.50	71 / 85	16.3	0.05/0.60	50 / 110	45.0	0.13/1.50
RS 130	50.0	2.75	80 / 60	10.5	0.10/0.25	RS60 / 130	57.0	0.23/2.75
RS 150	80.0	4.40	80 / 70	13.0	0.10/0.35	RS70 / 150	90.0	0.35/4.40
			80 / 85	17.5	0.10/0.60			
			80 / 110	43.0	0.10/1.50			
			100 / 110	46.0	0.20/1.50			
			RS100/130	64.0	0.20/2.75			
			RS 100/150	94.0	0.20/4.40			

- CARICHI RADIALI ENTRATA R<sub>1</sub> [daN]
- INPUT RADIAL LOADS R<sub>1</sub> [daN]
- RADIALKRÄFTE EINGANG R<sub>1</sub> [daN]

$$A_1 = 0.2 \times R_1$$

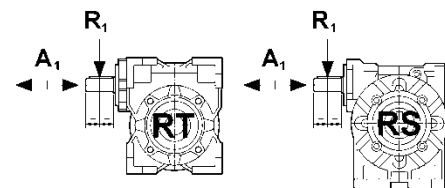

rpm	2800	1400	900	700	500	300
RS-RT 28	5	7	8	9	10	12
RS-RT 40	11	15	16	17	18	20
RS-RT 50	15	20	22	25	28	30
RS-RT 60	23	30	33	35	37	40
RS-RT 70	26	35	40	44	47	50
RS-RT 85	34	45	52	58	62	70
RS-RT 110	57	75	80	85	92	100
RS 130	70	100	105	110	115	120
RS 150	90	120	125	130	140	150

# RS-RT Riduttori - Gearboxes - Getriebe

## Carichi esterni - Output loads - Ausgangskräfte

- CARICHI RADIALI  $R_2$  [daN] CON CUSCINETTI STANDARD
- RADIAL LOADS  $R_2$  [daN] WITH STANDARD BEARINGS
- RADIALKRÄFTE  $R_2$  [daN] MIT STANDARDLAGERUNG

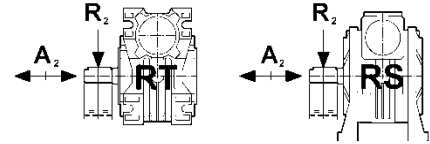

$$A_2 = 0.2 \times R_2$$

rpm	280	200	140	93	70	50	35	29	25	20	18	14	Brg No.
RS-RT28	---	45	50	55	60	62	70	75	80	90	95	100	16005
RS-RT40	100	100	110	120	135	150	160	170	180	190	200	230	16006
RS-RT50	145	125	145	170	190	200	230	240	260	280	290	320	16008
RS-RT60	225	240	250	290	330	360	390	430	460	500	530	560	①
RS-RT70	260	270	290	360	390	420	450	520	550	590	630	670	②
RS-RT85	330	330	370	440	470	540	550	630	660	710	750	830	③
RS-RT110	---	390	415	520	540	590	570	750	780	800	880	980	④
RS130	---	500	585	615	650	660	780	880	950	970	1050	1150	6015
RS150	---	650	770	830	880	900	1100	1200	1250	1300	1400	1500	6216

① RS: 6008 / RT: 6208

③ RS: 6010 / RT: 6210

② RS: 6009 / RT: 6209

④ RS: 6012 / RT: 6212

- CARICHI RADIALI  $R_2$  [daN] CON CUSCINETTI RINFORZATI
- RADIAL LOADS  $R_2$  [daN] WITH HEAVY DUTY BEARINGS
- RADIALKRÄFTE  $R_2$  [daN] MIT VERSTÄRKTER LAGERUNG

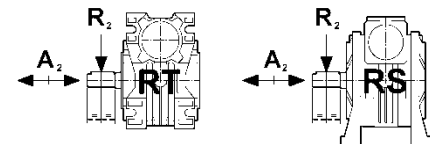

$$A_2 = 0.2 \times R_2$$

rpm <sup>1</sup>	280	200	140	93	70	50	35	29	25	20	18	14	Brg No.
RS-RT28	---	65	75	82	90	93	105	112	120	130	130	130	6005
RS-RT40	140	150	155	165	190	210	225	240	250	260	260	260	32006
RS-RT50	200	175	200	240	260	300	340	360	390	420	420	420	32008
RS-RT60	290	300	320	370	420	480	510	570	610	660	660	660	30208
RS-RT70	335	330	370	450	516	560	610	690	730	790	790	790	⑤
RS-RT85	410	420	460	550	630	720	730	840	870	940	940	940	⑥
RS-RT110	---	500	540	670	750	800	930	1050	1110	1110	1110	1110	⑦
RS130	---	700	790	860	970	990	1170	1290	1420	1450	1450	1450	32015
RS150	---	900	1080	1160	1320	1350	1650	1800	1870	1950	1950	1950	30216

⑤ RS:32009 / RT: 30209

⑥ RS: 32010 / RT: 30210

⑦ RS:32012 / RT: 30212

# RS-RT

# Getriebe - Gearboxes - Riduttori RS-RT

Baugrößen motor - Motor frames - Grandezze motori

FRS FRT	rpm	i = 5	7	10	15	20	28	40	49	56	70	80	100
	IEC	280	200	140	93	70	50	35	29	25	20	18	14
28	56	---	⊙	⊙	⊙	⊙	⊙	⊙	⊙	⊙	⊙	⊙	⊙
	63	---	⊙	⊙	⊙	⊙	⊙	⊙	⊙	⊙	⊙	⊙	⊙
40	56	⊙	⊙	⊙	⊙	⊙	⊙	⊙	⊙	⊙	⊙	⊙	⊙
	63	⊙	⊙	⊙	⊙	⊙	⊙	⊙	⊙	⊙	⊙	⊙	⊙
	71	⊙	⊙	⊙	⊙	⊙	⊙	⊙	⊙	⊙	⊙	⊙	⊙
50	63	⊙	⊙	⊙	⊙	⊙	⊙	⊙	⊙	⊙	⊙	⊙	⊙
	71	⊙	⊙	⊙	⊙	⊙	⊙	⊙	⊙	⊙	⊙	⊙	⊙
	80	⊙	⊙	⊙	⊙	⊙	⊙	⊙	⊙	⊙	⊙	⊙	⊙
60	71	⊙	⊙	⊙	⊙	⊙	⊙	⊙	⊙	⊙	⊙	⊙	⊙
	80	⊙	⊙	⊙	⊙	⊙	⊙	⊙	⊙	⊙	⊙	⊙	⊙
	90	⊙	⊙	⊙	⊙	⊙	⊙	⊙	⊙	⊙	⊙	⊙	⊙
70	71	⊙	⊙	⊙	⊙	⊙	⊙	⊙	⊙	⊙	⊙	⊙	⊙
	80	⊙	⊙	⊙	⊙	⊙	⊙	⊙	⊙	⊙	⊙	⊙	⊙
	90	⊙	⊙	⊙	⊙	⊙	⊙	⊙	⊙	⊙	⊙	⊙	⊙
	100	⊙	⊙	⊙	⊙	⊙	⊙	⊙	⊙	⊙	⊙	⊙	⊙
85	80	⊙	⊙	⊙	⊙	⊙	⊙	⊙	⊙	⊙	⊙	⊙	⊙
	90	⊙	⊙	⊙	⊙	⊙	⊙	⊙	⊙	⊙	⊙	⊙	⊙
	100/112	⊙	⊙	⊙	⊙	⊙	⊙	⊙	⊙	⊙	⊙	⊙	⊙
110	90	---	⊙	⊙	⊙	⊙	⊙	⊙	⊙	⊙	⊙	⊙	⊙
	100/112	---	⊙	⊙	⊙	⊙	⊙	⊙	⊙	⊙	⊙	⊙	⊙
	132	---	○	○	○	○	---	---	---	---	---	---	---
RS 130	100/112	---	○	○	○	○	○	○	○	○	○	○	○
	132	---	○	○	○	○	○	○	---	---	---	---	---
RS 150	100/112	---	○	○	○	○	○	○	○	○	○	○	○
	132	---	○	○	○	○	○	○	○	○	---	---	---
	160	---	○	○	○	○	○	○	○	---	---	---	---

Entrata - Input - Eingang

- ⊙ - B5 & B14 (Giunto G - Coupling G - Kupplung G)
- ⊙ - B5 (Giunto G - Coupling G - Kupplung G)
- - B5 & B14 (Foro e chiavetta - Bore and key - Bohrung u. Keil)
- - B5 (Foro e chiavetta - Bore and key - Bohrung u. Keil)

FRA FTA	IEC *	7 **	10 **	15 **	20 **	28 **	40 **	49 **	56 **	70 **	80 **	100 **
63/40	56	①	①	①	①	①	①	①	①	①	①	①
63/50	B5&B14	①	①	①	①	①	①	①	①	①	①	①
63/60		---	---	---	---	①	①	①	①	①	①	①
63/40	63	①	①	①	①	①	①	①	①	①	①	①
63/50	B5&B14	①	①	①	①	①	①	①	①	①	①	①
63/60		---	---	---	---	①	①	①	①	①	①	①
71/50	71	②	②	②	②	②	②	②	⑦	⑦	⑦	⑦
71/60	B5&B14	②	②	②	②	②	②	②	②	②	②	②
71/70		②	②	②	②	②	②	②	②	②	②	②
71/85		---	---	---	---	---	②	②	②	②	②	②
80/60	80	③	③	③	③	③	⑧	⑧	⑧	⑧	⑧	⑧
80/70	B5&B14	③	③	③	③	③	③	③	⑧	⑧	⑧	⑧
80/85		③	③	③	③	③	③	③	③	③	③	③
80/110		④	④	④	④	③	③	③	③	③	③	③
80/60	90	③	③	③	③	③	⑧	⑧	⑧	⑧	⑧	⑧
80/70	B5&B14	③	③	③	③	③	③	③	⑧	⑧	⑧	⑧
80/85		③	③	③	③	③	③	③	③	③	③	③
80/110		④	④	④	④	③	③	③	③	③	③	③
100/110		④	④	④	④	③	③	③	③	③	③	③
FRA 100/130	90 B5&B14	⑤	⑤	⑤	⑤	⑤	⑤	⑤	⑤	⑤	⑤	⑤
	100 B5&B14	⑤	⑤	⑤	⑤	⑤	⑤	⑤	⑤	⑤	⑤	⑤
FRA 100/150	90 B5&B14	⑥	⑥	⑥	⑤	⑤	⑤	⑤	⑤	⑤	⑤	⑤
	100 B5&B14	⑥	⑥	⑥	⑤	⑤	⑤	⑤	⑤	⑤	⑤	⑤

\* - Entrata precoppia FXA  
\*\* - Uscita precoppia FXA  
& Entrata FRS/FRT

- ① - ø105 x 14
- ② - ø120 x 19
- ③ - ø140 x 24
- ④ - ø140 x 28
- ⑤ - ø200 x 28
- ⑥ - ø200 x 28 (Foro vite ø38 mm  
& Boccia ø38/ø28)

\* - FXA helical stage input  
\*\* - FXA helical stage output  
& FRS/FRT input

- ① - ø105 x 14
- ② - ø120 x 19
- ③ - ø140 x 24
- ④ - ø140 x 28
- ⑤ - ø200 x 28
- ⑥ - ø200 x 28 (Wormshaft bore ø38 mm  
& Adapter ø38/ø28)

\* - Eingang der Vorstufe FXA  
\*\* - Ausgang der Vorstufe FXA  
u. Eingang der Getriebe FRS/FRT

- ① - ø105 x 14
- ② - ø120 x 19
- ③ - ø140 x 24
- ④ - ø140 x 28
- ⑤ - ø200 x 28
- ⑥ - ø200 x 28 (Schneckebohrung ø38 mm  
u. Buchse ø38/ø28)

# RS-RT

# Getriebe - Gearboxes - Riduttori RS-RT

(2800 rpm)

Auswahltabelle - Selection table - Tabella selezione

RS RT	i =	5	7	10	15	20	28	40	49	56	70	80	100
	rpm	560	400	280	187	140	100	70	57	50	40	35	28
RS - RT 28	kW	---	0,63	0,49	0,35	0,25	0,23	0,16	0,13	0,12	0,09	0,08	0,04
	Nm	---	13	14	14	13	15	14	13	12	11	10	7
	eff.	---	0,86	0,83	0,79	0,77	0,69	0,64	0,61	0,54	0,49	0,49	0,46
	$J_1 \times 10^{-6}$	---	6,0100	5,5500	5,3000	5,2100	5,1600	5,1300	5,1200	5,1200	5,1100	5,1100	5,1100
RS - RT 40	kW	2,1	1,5	1,2	0,82	0,56	0,49	0,36	0,30	0,26	0,21	0,19	0,15
	Nm	32	31	34	34	30	34	32	31	30	29	28	26
	eff.	0,89	0,87	0,85	0,81	0,78	0,72	0,66	0,62	0,6	0,57	0,54	0,51
	$J_1 \times 10^{-5}$	2,2750	2,2130	2,0040	1,8920	1,8530	1,8280	1,8150	1,8110	1,8090	1,8060	1,8050	1,8040
RS - RT 50	kW	3,8	3,0	2,0	1,5	0,95	0,92	0,63	0,51	0,43	0,33	0,31	0,23
	Nm	58	62	59	61	52	66	59	56	53	46	49	40
	eff.	0,90	0,88	0,86	0,82	0,8	0,75	0,69	0,66	0,64	0,58	0,58	0,52
	$J_1 \times 10^{-5}$	7,1680	6,0680	5,3610	4,9830	4,8510	4,7680	4,7240	4,7100	4,7030	4,6950	4,6920	4,6880
RS - RT 60	kW	5,8	4,4	3,5	2,6	1,9	1,6	1,1	0,72	0,73	0,60	0,52	0,34
	Nm	90	93	104	110	108	116	105	85	92	92	85	68
	eff.	0,90	0,88	0,87	0,84	0,82	0,76	0,73	0,71	0,66	0,64	0,6	0,58
	$J_1 \times 10^{-4}$	1,3740	1,3443	1,1860	1,1016	1,0720	1,0534	1,0435	1,0403	1,0388	1,0371	1,0364	1,0355
RS - RT 70	kW	8,1	5,7	4,3	3,2	2,4	2,2	1,5	1,2	1,0	0,80	0,69	0,54
	Nm	126	122	130	139	136	161	155	142	130	120	115	107
	eff.	0,91	0,89	0,88	0,85	0,83	0,78	0,74	0,7	0,68	0,63	0,61	0,58
	$J_1 \times 10^{-4}$	3,3190	3,0626	2,7418	2,5706	2,5107	2,4729	2,4529	2,4464	2,4434	2,4399	2,4384	2,4367
RS - RT 85	kW	13,0	9,6	7,5	5,3	4,3	3,1	2,4	2,0	1,7	1,3	1,1	0,93
	Nm	202	205	225	234	237	235	250	242	229	210	200	190
	eff.	0,91	0,89	0,88	0,86	0,8	0,8	0,76	0,72	0,71	0,67	0,64	0,6
	$J_1 \times 10^{-4}$	5,0250	4,8911	4,1250	3,7160	3,5729	3,4828	3,4349	3,4196	3,4124	3,4039	3,4004	3,3963
RS - RT 110	kW	---	17,5	14,8	10,7	8,6	7,0	5,0	4,5	3,6	3,1	3,0	2,1
	Nm	---	375	445	470	490	530	520	545	490	525	540	450
	eff.	---	0,9	0,88	0,86	0,84	0,79	0,76	0,73	0,71	0,7	0,67	0,62
	$J_1 \times 10^{-3}$	---	2,2160	1,9420	1,7960	1,7450	1,7130	1,6960	1,6910	1,6880	1,6850	1,6840	1,6820
RS 130	kW	---	26,3	21,6	15,8	12,2	9,4	7,7	6,0	5,3	3,9	3,3	2,4
	Nm	---	565	655	705	715	715	815	740	780	670	620	560
	eff.	---	0,9	0,89	0,87	0,86	0,8	0,78	0,74	0,77	0,72	0,68	0,68
	$J_1 \times 10^{-3}$	---	3,9443	3,2820	2,9284	2,8047	2,7268	2,6854	2,6721	2,6659	2,6586	2,6555	2,6520
RS 150	kW	---	37,0	29,6	22,8	17,1	13,6	10,7	8,5	6,6	5,5	4,9	3,6
	Nm	---	795	900	1015	1005	1065	1170	1090	970	950	915	845
	eff.	---	0,9	0,89	0,87	0,86	0,82	0,8	0,77	0,77	0,72	0,68	0,68
	$J_1 \times 10^{-3}$	---	8,1739	6,9606	6,3130	6,0863	5,9436	5,8678	5,8435	5,8321	5,8187	5,8131	5,8066

RS RT	i =	5	7	10	15	20	28	40	49	56	70	80	100
	rpm	280	200	140	93	70	50	35	29	25	20	18	14
RS - RT 28	kW	---	0,45	0,33	0,23	0,16	0,16	0,10	0,09	0,08	0,06	0,05	0,03
	Nm	---	18	18	18	16	20	17	17	15	12	12	8
	eff.	---	0,84	0,81	0,77	0,74	0,66	0,62	0,57	0,51	0,45	0,45	0,43
	$J_1 \times 10^{-6}$	---	6,0100	5,5500	5,3000	5,2100	5,1600	5,1300	5,1200	5,1200	5,1100	5,1100	5,1100
RS - RT 40	kW	1,5	1,1	0,81	0,55	0,38	0,37	0,25	0,21	0,18	0,14	0,12	0,09
	Nm	45	45	46	44	39	48	42	41	38	36	32	29
	eff.	0,87	0,85	0,83	0,78	0,75	0,68	0,61	0,58	0,56	0,52	0,50	0,46
	$J_1 \times 10^{-5}$	2,2750	2,2130	2,0040	1,8920	1,8530	1,8280	1,8150	1,8110	1,8090	1,8060	1,8050	1,8040
RS - RT 50	kW	2,7	1,8	1,3	0,93	0,63	0,63	0,41	0,37	0,31	0,25	0,20	0,13
	Nm	81	75	75	74	65	85	72	76	71	63	58	43
	eff.	0,88	0,86	0,84	0,78	0,76	0,71	0,64	0,62	0,60	0,53	0,52	0,47
	$J_1 \times 10^{-5}$	7,1680	6,0680	5,3610	4,9830	4,8510	4,7680	4,7240	4,7100	4,7030	4,6950	4,6920	4,6880
RS - RT 60	kW	4,1	2,8	2,3	1,6	1,2	1,0	0,75	0,62	0,54	0,46	0,37	0,25
	Nm	125	113	133	130	122	139	135	128	123	122	106	83
	eff.	0,89	0,86	0,84	0,81	0,77	0,71	0,66	0,62	0,60	0,55	0,53	0,49
	$J_1 \times 10^{-4}$	1,3740	1,3443	1,1860	1,1016	1,0720	1,0534	1,0435	1,0403	1,0388	1,0371	1,0364	1,0355
RS - RT 70	kW	5,7	4,0	3,1	2,2	1,8	1,5	1,2	0,84	0,74	0,58	0,50	0,37
	Nm	176	166	180	188	194	216	238	189	180	163	154	130
	eff.	0,89	0,88	0,86	0,83	0,81	0,75	0,71	0,67	0,64	0,59	0,56	0,52
	$J_1 \times 10^{-4}$	3,3190	3,0626	2,7418	2,5706	2,5107	2,4729	2,4529	2,4464	2,4434	2,4399	2,4384	2,4367
RS - RT 85	kW	9,1	6,2	4,6	3,4	2,9	2,2	1,6	1,4	1,2	0,96	0,86	0,55
	Nm	279	259	268	289	322	319	325	316	305	290	280	210
	eff.	0,90	0,88	0,86	0,83	0,82	0,76	0,72	0,67	0,68	0,63	0,60	0,56
	$J_1 \times 10^{-4}$	5,0250	4,8911	4,1250	3,7160	3,5729	3,4828	3,4349	3,4196	3,4124	3,4039	3,4004	3,3963
RS - RT 110	kW	---	12,5	9,0	6,5	5,7	4,4	3,5	2,7	2,2	2,0	1,5	1,1
	Nm	---	525	532	560	647	642	691	631	595	635	525	469
	eff.	---	0,88	0,87	0,84	0,83	0,76	0,73	0,71	0,70	0,67	0,66	0,61
	$J_1 \times 10^{-3}$	---	2,2160	1,9420	1,7960	1,7450	1,7130	1,6960	1,6910	1,6880	1,6850	1,6840	1,6820
RS 130	kW	---	19,0	15,0	11,0	8,5	7,5	5,5	3,9	3,7	2,7	2,4	1,8
	Nm	---	807	890	960	975	1100	1140	950	1005	865	810	750
	eff.	---	0,89	0,87	0,85	0,84	0,77	0,76	0,72	0,71	0,67	0,63	0,61
	$J_1 \times 10^{-3}$	---	3,9443	3,2820	2,9284	2,8047	2,7268	2,6854	2,6721	2,6659	2,6586	2,6555	2,6520
RS 150	kW	---	24,9	21,0	16,0	12,5	9,5	8,0	5,9	5,1	3,8	3,3	2,6
	Nm	---	1060	1260	1410	1430	1435	1680	1440	1420	1230	1170	1120
	eff.	---	0,89	0,88	0,86	0,84	0,79	0,77	0,73	0,73	0,68	0,65	0,63
	$J_1 \times 10^{-3}$	---	8,1739	6,9606	6,3130	6,0863	5,9436	5,8678	5,8435	5,8321	5,8187	5,8131	5,8066



# RS-RT

# Getriebe - Gearboxes - Riduttori RS-RT

(900 rpm)

Auswahltabelle - Selection table - Tabella selezione

RS RT	i =	5	7	10	15	20	28	40	49	56	70	80	100
	rpm	180	128	90	60	45	32	23	19	16	13	11	9
RS - RT 28	kW	---	0,36	0,24	0,18	0,13	0,12	0,08	0,07	0,06	0,04	0,03	0,02
	Nm	---	22	20	21	19	22	20	19	16	13	11	8
	eff.	---	0,82	0,78	0,72	0,70	0,61	0,56	0,52	0,45	0,43	0,40	0,37
	$J_1 \times 10^{-6}$	---	6,0100	5,5500	5,3000	5,2100	5,1600	5,1300	5,1200	5,1200	5,1100	5,1100	5,1100
RS - RT 40	kW	1,2	0,84	0,64	0,44	0,30	0,28	0,19	0,16	0,14	0,12	0,10	0,08
	Nm	54	52	54	52	45	52	46	43	41	40	39	36
	eff.	0,86	0,83	0,80	0,74	0,70	0,63	0,56	0,52	0,49	0,46	0,44	0,42
	$J_1 \times 10^{-5}$	2,2750	2,2130	2,0040	1,8920	1,8530	1,8280	1,8150	1,8110	1,8090	1,8060	1,8050	1,8040
RS - RT 50	kW	2,1	1,5	1,1	0,75	0,52	0,51	0,35	0,28	0,25	0,19	0,17	0,12
	Nm	96	95	95	91	79	99	85	81	80	67	67	55
	eff.	0,86	0,85	0,81	0,76	0,72	0,65	0,58	0,56	0,54	0,47	0,46	0,42
	$J_1 \times 10^{-5}$	7,1680	6,0680	5,3610	4,9830	4,8510	4,7680	4,7240	4,7100	4,7030	4,6950	4,6920	4,6880
RS - RT 60	kW	3,2	2,4	1,9	1,4	1,0	0,87	0,56	0,43	0,40	0,32	0,28	0,19
	Nm	150	150	163	166	161	175	152	135	130	125	115	94
	eff.	0,87	0,85	0,83	0,75	0,76	0,68	0,64	0,61	0,55	0,53	0,480	0,47
	$J_1 \times 10^{-4}$	1,3740	1,3443	1,1860	1,1016	1,0720	1,0534	1,0435	1,0403	1,0388	1,0371	1,0364	1,0355
RS - RT 70	kW	4,5	3,2	2,4	1,7	1,3	1,2	0,87	0,64	0,53	0,42	0,38	0,30
	Nm	212	202	211	218	207	242	240	205	187	170	160	147
	eff.	0,88	0,86	0,83	0,79	0,77	0,70	0,654	0,62	0,59	0,54	0,50	0,46
	$J_1 \times 10^{-4}$	3,3190	3,0626	2,7418	2,5706	2,5107	2,4729	2,4529	2,4464	2,4434	2,4399	2,4384	2,4367
RS - RT 85	kW	7,2	5,0	3,9	3,0	2,1	1,8	1,5	1,0	0,83	0,73	0,64	0,51
	Nm	338	320	350	378	355	373	410	350	332	300	290	260
	eff.	0,88	0,86	0,84	0,80	0,78	0,71	0,66	0,672	0,671	0,55	0,53	0,48
	$J_1 \times 10^{-4}$	5,0250	4,8911	4,1250	3,7160	3,5729	3,4828	3,4349	3,4196	3,4124	3,4039	3,4004	3,3963
RS - RT 110	kW	---	9,8	8,0	5,7	4,4	3,7	2,7	2,3	1,9	1,7	1,5	0,94
	Nm	---	635	720	745	745	795	780	780	690	765	715	500
	eff.	---	0,87	0,85	0,82	0,79	0,73	0,68	0,64	0,62	0,59	0,57	0,50
	$J_1 \times 10^{-3}$	---	2,2160	1,9420	1,7960	1,7450	1,7130	1,6960	1,6910	1,6880	1,6850	1,6840	1,6820
RS 130	kW	---	14,9	11,7	8,4	6,5	5,1	4,1	3,1	2,8	2,1	1,8	1,3
	Nm	---	975	1070	1115	1115	1145	1215	1095	1145	960	890	805
	eff.	---	0,88	0,86	0,83	0,81	0,75	0,70	0,67	0,68	0,63	0,58	0,57
	$J_1 \times 10^{-3}$	---	3,9443	3,2820	2,9284	2,8047	2,7268	2,6854	2,6721	2,6659	2,6586	2,6555	2,6520
RS 150	kW	---	20,8	15,9	12,2	9,3	7,3	5,6	4,5	3,3	2,9	2,5	2,0
	Nm	---	1360	1470	1635	1625	1660	1740	1600	1370	1390	1290	1230
	eff.	---	0,88	0,87	0,84	0,82	0,77	0,73	0,69	0,69	0,64	0,61	0,58
	$J_1 \times 10^{-3}$	---	8,1739	6,9606	6,3130	6,0863	5,9436	5,8678	5,8435	5,8321	5,8187	5,8131	5,8066

# RS-RT Riduttori - Gearboxes - Getriebe

# RS-RT

Tabella selezione - Selection table - Auswahltable

(700 rpm)

RS RT	i =	5	7	10	15	20	28	40	49	56	70	80	100
	rpm	140	100	70	47	35	25	18	15	13	10	8.7	7
RS - RT 28	kW	---	0,29	0,21	0,14	0,10	0,10	0,06	0,05	0,04	0,03	0,02	0,01
	Nm	---	23	23	22	21	24	21	20	17	13	11	8
	eff.	---	0.81	0.77	0.71	0.69	0.60	0.55	0.51	0.44	0.40	0.39	0.36
	$J_1 \times 10^{-6}$	---	6,0100	5,5500	5,3000	5,2100	5,1600	5,1300	5,1200	5,1200	5,1100	5,1100	5,1100
RS - RT 40	kW	1.00	0,74	0,54	0,39	0,26	0,24	0,17	0,14	0,12	0,10	0,09	0,07
	Nm	59	58	58	58	49	55	49	46	45	43	41	38
	eff.	0.85	0.82	0.79	0.73	0.68	0.59	0.53	0.50	0.48	0.44	0.42	0.39
	$J_1 \times 10^{-5}$	2,2750	2,2130	2,0040	1,8920	1,8530	1,8280	1,8150	1,8110	1,8090	1,8060	1,8050	1,8040
RS - RT 50	kW	1.8	1,4	0,92	0,65	0,44	0,43	0,29	0,24	0,21	0,16	0,15	0,12
	Nm	106	110	100	99	86	106	91	87	83	70	72	62
	eff.	0.86	0.83	0.80	0.75	0.71	0.64	0.57	0.542	0.52	0.45	0.44	0.39
	$J_1 \times 10^{-5}$	7,1680	6,0680	5,3610	4,9830	4,8510	4,7680	4,7240	4,7100	4,7030	4,6950	4,6920	4,6880
RS - RT 60	kW	2.8	2,0	1,6	1,1	0,87	0,73	0,49	0,35	0,34	0,26	0,24	0,17
	Nm	165	164	177	178	175	187	165	140	139	128	120	100
	eff.	0.87	0.84	0.81	0.77	0.74	0.67	0.62	0.59	0.54	0.51	0.46	0.44
	$J_1 \times 10^{-4}$	1,3740	1,3443	1,1860	1,1016	1,0720	1,0534	1,0435	1,0403	1,0388	1,0371	1,0364	1,0355
RS - RT 70	kW	3.9	2,7	2,1	1,4	1,1	1,0	0,71	0,55	0,46	0,36	0,32	0,24
	Nm	234	216	233	231	225	256	245	220	197	176	167	150
	eff.	0.87	0.85	0.82	0.78	0.75	0.68	0.63	0.60	0.56	0.51	0.48	0.45
	$J_1 \times 10^{-4}$	3,3190	3,0626	2,7418	2,5706	2,5107	2,4729	2,4529	2,4464	2,4434	2,4399	2,4384	2,4367
RS - RT 85	kW	6.2	4,6	3,5	2,5	1,9	1,5	1,2	0,93	0,78	0,59	0,56	0,44
	Nm	372	370	400	408	388	400	420	379	353	310	305	275
	eff.	0.87	0.85	0.83	0.79	0.76	0.69	0.65	0.61	0.59	0.55	0.50	0.46
	$J_1 \times 10^{-4}$	5,0250	4,8911	4,1250	3,7160	3,5729	3,4828	3,4349	3,4196	3,4124	3,4039	3,4004	3,3963
RS - RT 110	kW	---	8,5	6,8	4,9	3,9	3,3	2,3	2,0	1,7	1,5	1,2	0,79
	Nm	---	700	780	795	815	890	820	840	770	815	720	515
	eff.	---	0.86	0.84	0.80	0.77	0.71	0.66	0.62	0.60	0.57	0.55	0.48
	$J_1 \times 10^{-3}$	---	2,2160	1,9420	1,7960	1,7450	1,7130	1,6960	1,6910	1,6880	1,6850	1,6840	1,6820
RS 130	kW	---	12,8	10,3	7,4	5,6	4,4	3,6	2,7	2,4	1,8	1,6	1,1
	Nm	---	1060	1200	1230	1215	1200	1320	1185	1215	1030	955	855
	eff.	---	0.87	0.85	0.81	0.80	0.72	0.68	0.65	0.66	0.61	0.56	0.55
	$J_1 \times 10^{-3}$	---	3,9443	3,2820	2,9284	2,8047	2,7268	2,6854	2,6721	2,6659	2,6586	2,6555	2,6520
RS 150	kW	---	18,0	13,7	10,6	8,1	6,2	4,9	3,8	3,0	2,6	2,3	1,7
	Nm	---	1475	1610	1805	1780	1790	1890	1710	1535	1500	1425	1275
	eff.	---	0.87	0.86	0.83	0.81	0.75	0.71	0.68	0.67	0.61	0.58	0.56
	$J_1 \times 10^{-3}$	---	8,1739	6,9606	6,3130	6,0863	5,9436	5,8678	5,8435	5,8321	5,8187	5,8131	5,8066

# RA-TA

# Getriebe - Gearboxes - Riduttori RS-RT

(1400 rpm)

Auswahltabelle - Selection table - Tabella selezione

<b>XA</b>	$i_n =$	3.5	6.3	8
	rpm	400	225	175
XA63	$i_r =$	3.5	6.2	7.8
	kW	0.50	0.23	0.18
	Nm	12	10	9
	$R_2$ [N]	390	450	450
XA71	$i_r =$	3.5	6.4	8.0
	kW	1.1	0.52	0.37
	Nm	26	22	20
	$R_2$ [N]	490	560	560
XA80	$i_r =$	3.4	6.4	8.3
	kW	3.1	1.5	1.1
	Nm	68	65	60
	$R_2$ [N]	610	700	700
XA100	$i_r =$	3.9	6.2	7.5
	kW	8.7	4.0	2.2
	Nm	235	163	136
	$R_2$ [N]	1500	2500	2500

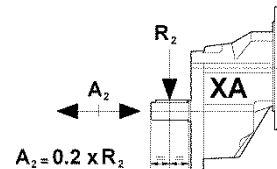

Dimensioni XA: pagina 52

XA Dimensions: page 52

XA Abmessungen: Seite 52

<b>RA TA</b>	$i = i_n \times i_2$	25	35	53	70	98	140	172	196	245	280	350
	rpm	57	40	27	20	14	10	8	7	6	5	4
	$i_2$	7	10	15	20	28	40	49	56	70	80	100
63/40	kW	0.55	0.40	0.28	0.20	0.19	0.13	0.11	0.10	0.06	0.05	0.03
	Nm	72	72	70	60	70	64	58	56	42	35	25
	eff.	0.78	0.75	0.70	0.63	0.56	0.50	0.46	0.44	0.41	0.40	0.35
63/50 71/50	kW	1.02	0.70	0.50	0.33	0.32	0.21	0.20	0.16	0.11	0.09	0.06
	Nm	135	127	125	105	125	105	115	100	80	70	50
	eff.	0.79	0.76	0.70	0.66	0.59	0.52	0.50	0.46	0.42	0.40	0.35
63/60 71/60 80/60	kW	1.53	1.18	0.83	0.57	0.53	0.33	0.27	0.23	0.19	0.15	0.10
	Nm	205	217	215	192	217	177	170	152	145	110	85
	eff.	0.80	0.77	0.72	0.70	0.61	0.57	0.54	0.49	0.45	0.38	0.36
71/70 80/70	kW	1.96	1.48	1.08	0.77	0.72	0.50	0.43	0.36	0.30	0.26	0.19
	Nm	265	275	285	260	310	270	270	235	225	200	180
	eff.	0.81	0.78	0.74	0.71	0.64	0.57	0.54	0.49	0.45	0.41	0.39
71/85 80/85	kW	3.14	2.39	1.77	1.37	1.11	0.80	0.65	0.58	0.49	0.40	0.26
	Nm	430	450	475	470	475	445	420	410	390	340	250
	eff.	0.82	0.79	0.75	0.72	0.64	0.58	0.55	0.53	0.48	0.44	0.40
80/110 100/110	kW	6.02	4.63	3.58	2.61	2.18	1.60	1.27	1.12	0.86	0.86	0.54
	Nm	835	895	950	910	960	950	850	820	750	740	540
	eff.	0.83	0.81	0.74	0.73	0.66	0.62	0.57	0.55	0.52	0.45	0.42
100/130	kW	7.0	6.8	5.5	3.8	3.1	2.3	1.7	1.5	1.3	1.1	0.8
	Nm	975	1320	1495	1350	1430	1380	1300	1250	1200	1080	880
	eff.	0.83	0.81	0.77	0.75	0.67	0.63	0.64	0.62	0.60	0.50	0.48
100/150	kW	7.9	7.8	7.5	5.7	4.5	3.3	2.7	2.4	1.8	1.6	1.0
	Nm	1115	1535	2090	2060	2130	2050	2040	2025	1700	1459	1200
	eff.	0.84	0.82	0.79	0.76	0.69	0.66	0.64	0.62	0.60	0.52	0.50

RA TA $i_n=6.3$	$i = i_1 \times i_2$	44	63	95	126	176	252	309	353	441	504	630
	rpm	32	22	15	11	8	5.5	4.6	4	3.2	2.8	2.2
	$i_2$	7	10	15	20	28	40	49	56	70	80	100
63/40	kW	0.35	0.25	0.17	0.12	0.11	0.08	0.06	0.06	0.05	0.04	0.03
	Nm	79	78	74	63	69	63	57	55	53	51	46
	eff.	0.76	0.72	0.67	0.60	0.52	0.45	0.43	0.39	0.35	0.34	0.31
63/50 71/50	kW	0.62	0.42	0.30	0.20	0.20	0.14	0.11	0.10	0.09	0.07	0.05
	Nm	145	133	130	113	138	115	108	100	92	89	72
	eff.	0.78	0.74	0.67	0.63	0.55	0.48	0.45	0.42	0.36	0.36	0.31
63/60 71/60 80/60	kW	0.92	0.74	0.52	0.40	0.35	0.23	0.16	0.16	0.11	0.10	0.08
	Nm	218	237	235	230	238	210	160	175	141	130	122
	eff.	0.79	0.75	0.70	0.67	0.57	0.53	0.49	0.45	0.42	0.37	0.35
71/70 80/70	kW	1.2	0.95	0.68	0.50	0.44	0.32	0.26	0.23	0.18	0.17	0.12
	Nm	289	310	310	292	320	259	272	254	221	210	190
	eff.	0.80	0.76	0.71	0.68	0.60	0.54	0.50	0.46	0.42	0.37	0.36
71/85 80/85	kW	2.0	1.6	1.1	0.84	0.69	0.53	0.43	0.37	0.28	0.26	0.22
	Nm	490	526	516	495	501	500	466	449	391	380	345
	eff.	0.80	0.77	0.72	0.69	0.60	0.55	0.51	0.50	0.46	0.42	0.36
80/110 100/110	kW	4.3	3.2	2.4	1.8	1.6	1.1	1.0	0.80	0.66	0.51	0.32
	Nm	1030	1100	1150	1100	1170	1110	1100	995	950	780	550
	eff.	0.81	0.79	0.74	0.71	0.63	0.57	0.53	0.52	0.48	0.45	0.39
100/130	kW	6.41	4.94	3.72	2.71	2.37	1.65	1.47	1.25	1.02	0.82	0.47
	Nm	1600	1700	1800	1700	1800	1700	1700	1600	1600	1300	900
	eff.	0.83	0.80	0.75	0.73	0.63	0.60	0.55	0.53	0.52	0.46	0.45
100/150	kW	8.41	6.61	5.04	3.77	3.02	2.31	1.82	1.41	1.24	1.09	0.84
	Nm	2100	2300	2500	2400	2400	2500	2300	2000	1800	1800	1700
	eff.	0.83	0.81	0.77	0.74	0.66	0.63	0.60	0.59	0.81	0.48	0.47

# RA-TA

# Getriebe - Gearboxes - Riduttori RS-RT

(1400 rpm)

Auswahltabelle - Selection table - Tabella selezione

RA TA $i_n=8$	$i = i_1 \times i_2$	56	80	120	160	224	320	392	448	560	640	800
	rpm	25	18	12	9	6	4	3.5	3	2.5	2.2	1.75
	$i_2$	7	10	15	20	28	40	49	56	70	80	100
63/40	kW	0.32	0.23	0.16	0.11	0.11	0.08	0.06	0.05	0.03	0.03	0.02
	Nm	93	89	84	72	85	75	69	59	45	38	27
	eff.	0.75	0.72	0.65	0.59	0.50	0.44	0.41	0.38	0.36	0.34	0.31
63/50 71/50	kW	0.58	0.41	0.28	0.20	0.18	0.13	0.10	0.09	0.06	0.05	0.03
	Nm	170	165	154	130	150	130	120	115	86	73	53
	eff.	0.77	0.73	0.67	0.61	0.55	0.47	0.45	0.41	0.36	0.37	0.31
63/60 71/60 80/60	kW	0.87	0.68	0.49	0.34	0.31	0.21	0.16	0.15	0.10	0.08	0.05
	Nm	260	280	275	240	270	235	220	200	155	125	92
	eff.	0.78	0.75	0.69	0.65	0.57	0.51	0.50	0.43	0.41	0.37	0.35
71/70 80/70	kW	1.26	0.88	0.63	0.44	0.48	0.28	0.24	0.20	0.16	0.12	0.05
	Nm	380	365	360	325	440	320	320	275	245	200	145
	eff.	0.79	0.76	0.70	0.67	0.60	0.53	0.50	0.45	0.41	0.38	0.35
71/85 80/85	kW	1.76	1.42	1.07	0.85	0.65	0.48	0.40	0.33	0.26	0.20	0.13
	Nm	530	595	620	620	600	560	550	510	450	360	260
	eff.	0.79	0.77	0.71	0.67	0.60	0.54	0.52	0.50	0.45	0.41	0.37
80/110 100/110	kW	3.42	2.75	1.97	1.52	1.29	0.97	0.73	0.64	0.52	0.43	0.27
	Nm	1045	1170	1180	1160	1200	1180	1020	980	920	850	550
	eff.	0.80	0.78	0.73	0.70	0.61	0.56	0.52	0.50	0.46	0.45	0.38
100/130	kW	3.3	3.0	3.2	2.3	1.8	1.2	1.1	0.9	0.7	0.7	0.5
	Nm	1000	1240	1840	1765	1760	1700	1660	1600	1435	1330	1160
	eff.	0.80	0.78	0.73	0.72	0.62	0.58	0.56	0.54	0.51	0.45	0.43
100/150	kW	3.7	3.4	3.6	3.4	2.7	2.0	1.7	1.4	1.1	1.0	0.8
	Nm	1130	1425	2150	2580	2675	2860	2550	2490	2110	1970	1855
	eff.	0.81	0.79	0.75	0.72	0.63	0.61	0.56	0.57	0.49	0.46	0.45

# RS-RT Riduttori - Gearboxes - Getriebe

# RS/RS-RT/RT

Tabella selezione - Selection table - Auswahltable

(1400 rpm)

RS / RS RT / RT	$i = i_1 \times i_2$	420	560	784	1120	1568	2240	2800	4000	5600	8000	10000
	rpm	3.3	2.5	1.8	1.25	0.9	0.6	0.5	0.35	0.25	0.17	0.14
	$i_1 =$	15	20	28	40	56	56	70	100	100	100	100
	$i_2 =$	28	28	28	28	28	40	40	40	56	80	100
28 / 28	W	32	25	21	16	13	9	8	6	3	1.8	1.3
	Nm	35	36	36	36	35	30	30	30	16	12	11
	eff.	0.38	0.37	0.32	0.30	0.25	0.21	0.20	0.18	0.14	0.12	0.13
28 / 40	W	75	60	46	34	30	22	22	14	11	5	3
	Nm	85	85	80	80	80	73	76	70	62	41	25
	eff.	0.39	0.37	0.33	0.31	0.25	0.21	0.18	0.18	0.15	0.14	0.12
28 / 50	W	133	106	91	74	60	36	36	28	20	10	6
	Nm	150	150	160	175	160	125	131	147	125	78	49
	eff.	0.39	0.37	0.33	0.31	0.25	0.22	0.19	0.19	0.16	0.14	0.12
28 / 60	W	197	157	132	91	91	67	54	30	32	16	10
	Nm	240	240	245	230	260	245	217	164	195	128	91
	eff.	0.42	0.40	0.35	0.33	0.27	0.23	0.21	0.20	0.16	0.14	0.13
40 / 70	W	298	249	198	157	119	86	72	60	42	24	16
	Nm	380	400	400	395	380	370	345	360	321	201	154
	eff.	0.44	0.42	0.38	0.33	0.30	0.27	0.25	0.22	0.20	0.15	0.14
40 / 85	W	447	372	276	224	180	138	120	90	72	39	26
	Nm	595	625	585	625	610	615	595	565	550	373	264
	eff.	0.46	0.44	0.40	0.35	0.32	0.28	0.26	0.23	0.20	0.17	0.15
50 / 110	W	865	756	579	453	382	292	235	163	128	82	51
	Nm	1190	1300	1300	1280	1350	1340	1210	1070	980	810	560
	eff.	0.48	0.45	0.42	0.37	0.33	0.30	0.27	0.24	0.20	0.18	0.16
RS 60 / 130	kW	1.5	1.1	0.75	0.55	0.55	0.37	0.25	0.25	0.25	0.25	0.25
	Nm	2015	1930	1670	1530	2015	1830	1410	1770	1850	1420	1225
	eff.	0.50	0.46	0.43	0.40	0.35	0.33	0.30	0.27	0.25	0.21	0.20
RS 70 / 150	kW	1.8	1.5	1.1	0.75	0.75	0.55	0.37	0.37	0.25	0.25	0.25
	Nm	2570	2830	2570	2460	2850	3020	2325	2875	2670	2135	1995
	eff.	0.52	0.50	0.46	0.43	0.39	0.36	0.33	0.31	0.27	0.23	0.22

# MRS-MRT

# Getriebe - Gearboxes - Riduttori RS-RT

(1400 rpm)

Auswahltabelle - Selection table - Tabella selezione

0.06 kW						0.09 kW					
	rpm	i =	Nm	SF	kg		rpm	i =	Nm	SF	kg
MRS-MRT28	200	7	2,4	>3	3,6	MRS-MRT 40	20	70	22	1,6	5,1
MRS-MRT 28	140	10	3,3	>3	3,6	MRS-MRT 40	18	80	25	1,3	5,1
MRS-MRT 28	93	15	4,7	>3	3,6	MRA-MTA 63/40	15	95	39	1,9	6,6
MRS-MRT 28	70	20	6,1	2,6	3,6	MRS-MRT 40	14	100	28	1,0	5,1
MRS-MRT 28	50	28	7,6	2,6	3,6	MRA-MTA 63/40	11	126	46	1,4	6,6
MRS-MRT 28	35	40	10	1,7	3,6	MRS-MRT 28 / 40	9,3	150	48	1,3	6,5
MRA-MTA 63/40	32	44	14	>3	6,5	MRA-MTA 63/40	8,0	176	56	1,2	6,6
MRS-MRT 28	29	49	11	1,5	3,6	MRS-MRT 28 / 40	7,0	200	60	1,3	6,5
MRS-MRT 28	25	56	12	1,3	3,6	MRA-MTA 63/40	5,5	252	70	0,9	6,6
MRA-MTA 63/40	22	63	19	>3	6,5	MRS-MRT 28 / 40	5,0	280	70	1,0	6,5
MRS-MRT 28	20	70	13	0,9	3,6	MRA-MTA 63/50	4,6	309	86	1,3	7,9
MRS-MRT 40	18	80	16	2,0	5,0	MRA-MTA 63/50	4,0	353	91	1,1	7,9
MRA-MTA 63/40	15	95	26	2,8	6,5	MRS-MRT 28 / 50	3,3	420	101	1,5	7,8
MRS-MRT 40	14	100	19	1,5	5,0	MRA-MTA 63/50	3,2	441	97	0,9	7,9
MRA-MTA 63/40	11	126	31	2,0	6,5	MRS-MRT 28 / 50	2,5	560	127	1,2	7,8
MRS-MRT 28 / 28	9,3	150	31	1,1	5,0	MRS-MRT 28 / 50	1,8	784	159	1,0	7,8
MRA-MTA 63/40	8,0	176	37	1,8	6,5	MRS-MRT 28 / 50	1,3	1120	213	0,8	7,8
MRS-MRT 28 / 28	7,0	200	30	0,8	5,0	MRS-MRT 28 / 60	0,9	1568	260	1,0	11
MRA-MTA 63/40	5,5	252	46	1,4	6,5	MRS-MRT 40 / 70	0,6	2240	371	1,0	15
MRS-MRT 28 / 28	5,0	280	35	0,8	5,0	MRS-MRT 40 / 85	0,5	2800	447	1,3	19
MRA-MTA 63/40	4,6	309	54	1,0	6,5	MRS-MRT 40 / 85	0,4	4000	565	1,0	19
MRA-MTA 63/40	4,0	353	56	1,0	6,5	MRS-MRT 40 / 85	0,3	5600	688	0,8	19
MRS-MRT 28 / 40	3,3	420	67	1,3	6,4						
MRA-MTA 63/50	3,2	441	65	1,4	7,8						
MRA-MTA 63/50	2,8	504	74	1,2	7,8						
MRS-MRT 28 / 40	2,5	560	85	1,0	6,4						
MRA-MTA 63/50	2,2	630	80	0,9	7,8						
MRS-MRT 28 / 50	1,8	784	106	1,5	7,7						
MRS-MRT 28 / 50	1,3	1120	142	1,2	7,7						
MRS-MRT 28 / 50	0,9	1560	160	1,0	7,7						
MRS-MRT 28 / 60	0,6	2240	211	1,2	10						
MRS-MRT 28 / 60	0,5	2800	241	0,9	10						
MRS-MRT 40 / 70	0,4	4000	360	1,0	15						
MRS-MRT 40 / 70	0,3	5600	458	0,7	15						
MRS-MRT 40 / 85	0,2	8000	557	0,7	19						
MRS-MRT 40 / 85	0,1	10000	614	0,4	19						
0,09 kW						0,12 kW					
	rpm	i =	Nm	SF	kg		rpm	i =	Nm	SF	kg
MRS-MRT 28	200	7	3,6	>3	3,7	MRS-MRT 28	200	7	4,8	>3	4,8
MRS-MRT 28	140	10	5,0	>3	3,7	MRS-MRT 28	140	10	6,6	2,7	4,8
MRS-MRT 28	93	15	7,1	2,5	3,7	MRS-MRT 28	93	15	9,5	1,9	4,8
MRS-MRT 28	70	20	9,1	1,8	3,7	MRS-MRT 28	70	20	12	1,3	4,8
MRS-MRT 28	50	28	11	1,8	3,7	MRS-MRT 28	50	28	15	1,3	4,8
MRS-MRT 28	35	40	15	1,1	3,7	MRS-MRT 40	35	40	20	2,1	6,2
MRA-MTA 63/40	32	44	21	>3	6,6	MRA-MTA 63/40	32	44	27	2,9	7,7
MRS-MRT 28	29	49	17	1,0	3,7	MRS-MRT 40	29	49	23	1,8	6,2
MRS-MRT 40	25	56	20	2,1	5,1	MRS-MRT 40	25	56	26	1,5	6,2
MRA-MTA 63/40	22	63	28	2,8	6,6	MRA-MTA 63/40	22	63	37	2,1	7,7
						MRS-MRT 40	20	70	30	1,2	6,2
						MRS-MRT 40	18	80	33	1,0	6,2
						MRA-MTA 63/40	15	95	52	1,4	7,7
						MRS-MRT 50	14	100	38	1,1	7,5
						MRA-MTA 63/40	11	126	62	1,0	7,7
						MRS-MRT 28 / 40	9,3	150	64	1,4	7,6
						MRA-MTA 63/40	8,0	176	75	0,9	7,7
						MRS-MRT 28 / 40	7,0	200	77	1,0	7,6
						MRA-MTA 63//50	5,5	252	99	1,2	9,0
						MRS-MRT 28 / 40	5,0	280	94	0,8	7,6
						MRA-MTA 63//50	4,6	309	114	0,9	9,0
						MRS-MRT 28 / 50	3,3	420	134	1,2	8,9
						MRS-MRT 28 / 50	2,5	560	170	0,9	8,9
						MRS-MRT 28 / 60	1,8	784	225	1,1	12

# RS-RT Riduttori - Gearboxes - Getriebe

# MRS-MRT

Tabella selezione - Selection table - Auswahltable

(1400 rpm)

0,12 kW						0,25 kW					
	rpm	i =	Nm	SF	kg		rpm	i =	Nm	SF	kg
MRS-MRT 28 / 60	1,3	1120	303	0,8	12	MRS-MRT 60	14	100	88	1,0	12
MRS-MRT 40 / 70	0,9	1568	385	1,0	16	MRA-MTA 71/60	11	126	144	1,6	15
MRS-MRT 40 / 85	0,6	2240	513	1,2	20	MRS-MRT 40 / 70	9,3	150	146	1,5	18
MRS-MRT 40 / 85	0,5	2800	596	1,0	20	MRA-MTA 71/60	8,0	176	171	1,4	15
MRS-MRT 40 / 85	0,4	4000	753	0,8	20	MRS-MRT 40 / 70	7,0	200	188	1,5	18
						MRA-MTA 71/70	5,5	252	232	1,3	18
0,18 kW						0,37 kW					
	rpm	i =	Nm	SF	kg		rpm	i =	Nm	SF	kg
MRS-MRT 28	200	7	7,2	2,5	5,4	MRS-MRT 40 / 70	5,0	280	224	1,5	18
MRS-MRT 28	140	10	9,9	1,8	5,4	MRA-MTA 71/70	4,6	309	263	1,0	18
MRS-MRT 28	93	15	14	1,3	5,4	MRA-MTA 71/70	4,0	353	277	0,9	18
MRS-MRT 28	70	20	18	0,8	5,4	MRS-MRT 40 / 70	3,3	420	315	1,2	18
MRS-MRT 40	50	28	23	2,1	6,8	MRS-MRT 40 / 70	2,5	560	401	1,0	18
MRS-MRT 40	35	40	30	1,4	6,8	MRS-MRT 40 / 85	1,8	784	535	1,1	22
MRA-MTA 63/40	32	44	41	1,9	8,3	MRS-MRT 50 / 110	1,3	1120	707	1,8	46
MRS-MRT 40	29	49	35	1,2	6,8	MRS-MRT 50 / 110	0,9	1568	882	1,5	46
MRS-MRT 40	25	56	39	1,0	6,2	MRS-MRT 50 / 110	0,6	2240	1146	1,2	46
MRA-MTA 63/40	22	63	56	1,4	8,3	MRS-MRT 50 / 110	0,5	2800	1289	0,9	46
MRS-MRT 50	20	70	46	1,4	8,1	0,55 kW					
MRS-MRT 50	18	80	51	1,1	8,1		rpm	i =	Nm	SF	kg
MRA-MTA 63/40	15	95	78	0,9	8,3	MRS-MRT 40	280	5	11	>3	8,7
MRS-MRT 50	14	100	43	0,8	8,1	MRS-MRT 40	200	7	15	3,0	8,7
MRA-MTA 63/50	11	126	97	1,2	9,6	MRS-MRT 40	140	10	21	2,2	8,7
MRS-MRT 28 / 50	9,3	150	93	1,6	9,5	MRS-MRT 40	93	15	30	1,5	8,7
MRA-MTA 63/50	8,0	176	119	1,2	9,6	MRS-MRT 40	70	20	38	1,0	8,7
MRS-MRT 28 / 50	7,0	200	120	1,1	9,5	MRS-MRT 40	50	28	48	1,0	8,7
MRS-MRT 28 / 50	5,0	280	141	1,1	9,5	MRS-MRT 50	35	40	65	1,1	10
MRS-MRT 28 / 60	3,3	420	217	1,1	12	MRA-MTA 71/50	32	44	87	1,7	13
MRS-MRT 40 / 70	2,5	560	289	1,4	16	MRS-MRT 50	29	49	77	1,0	10
MRS-MRT 40 / 70	1,8	784	366	1,1	16	MRS-MRT 60	25	56	85	1,5	13
MRS-MRT 40 / 85	1,3	1120	481	1,3	21	MRA-MTA 71/50	22	63	118	1,1	13
MRS-MRT 40 / 85	0,9	1568	616	1,0	21	MRS-MRT 60	20	70	97	1,3	13
MRS-MRT 40 / 85	0,6	2240	770	0,8	21	MRS-MRT 60	18	80	107	1,0	13
0,25 kW						MRA-MTA 71/60	15	95	168	1,4	16
	rpm	i =	Nm	SF	kg	MRS-MRT 70	14	100	130	1,0	15
MRS-MRT 40	280	5	7,5	>3	8,3	MRA-MTA 71/60	11	126	213	1,1	15
MRS-MRT 40	200	7	10	>3	8,3	MRS-MRT 40 / 70	9,3	150	217	2,1	18
MRS-MRT 40	140	10	14	>3	8,3	MRA-MTA 71/60	8,0	176	253	0,9	15
MRS-MRT 40	93	15	20	2,2	8,3	MRS-MRT 40 / 70	7,0	200	278	1,3	18
MRS-MRT 40	70	20	26	1,5	8,3	MRA-MTA 71/70	5,5	252	343	0,9	18
MRS-MRT 40	50	28	32	1,5	8,3	MRS-MRT 40 / 70	5,0	280	332	1,1	18
MRS-MRT 40	35	40	42	1,0	8,3	MRS-MRT 40 / 85	3,3	420	488	1,2	23
MRA-MTA 71/50	32	44	59	2,5	12	MRS-MRT 40 / 85	2,5	560	622	1,0	23
MRS-MRT 50	29	49	52	1,5	9,6	MRS-MRT 50 / 110	1,3	1120	1046	1,2	47
MRS-MRT 50	25	56	57	1,3	9,6	MRS-MRT 50 / 110	0,9	1568	1306	1,1	47
MRA-MTA 71/50	22	63	80	1,7	12	0,55 kW					
MRS-MRT 50	20	70	63	1,0	9,6		rpm	i =	Nm	SF	kg
MRS-MRT 60	18	80	72	1,5	12	MRS-MRT 40	280	5	16	2,8	10,7
MRA-MTA 71/50	95	95	109	1,2	12	MRS-MRT 50	200	7	23	>3	12
						MRS-MRT 50	140	10	32	2,4	12



# MRS-MRT

# Getriebe - Gearboxes - Riduttori RS-RT

(1400 rpm)

Auswahltable - Selection table - Tabella selezione

0,55 kW						1,1 kW					
	rpm	i =	Nm	SF	kg		rpm	i =	Nm	SF	kg
MRS-MRT 50	93	15	44	1,7	12	MRS-MRT 60	200	7	45	2,5	19
MRS-MRT 50	70	20	57	1,1	12	MRS-MRT 60	140	10	63	2,1	19
MRS-MRT 50	50	28	75	1,1	12	MRS-MRT 60	93	15	91	1,4	19
MRS-MRT 60	35	40	99	1,4	15	MRS-MRT 60	70	20	116	1,1	19
MRA-MTA 80/60	32	44	130	1,7	19	MRS-MRT 70	50	28	158	1,4	21
MRS-MRT 60	29	49	114	1,1	15	MRS-MRT 70	35	40	213	1,1	21
MRS-MRT 60	25	56	126	1,0	15	MRA-MTA 80/70	32	44	264	1,1	25
MRA-MTA 80/60	22	63	177	1,2	19	MRS-MRT 85	29	49	246	1,3	26
MRS-MRT 70	20	70	155	1,1	18	MRS-MRT 85	25	56	286	1,1	26
MRS-MRT 70	18	80	168	1,0	18	MRA-MTA 80/85	22	63	364	1,4	30
MRA-MTA 80/60	15	95	249	1,0	19	MRS-MRT 110	20	70	352	1,8	48
MRS-MRT 85	14	100	210	1,0	22	MRS-MRT 110	18	80	396	1,3	48
MRA-MTA 80/70	11	126	321	1,1	22	MRA-MTA 80/85	15	95	513	1,0	30
MRA-MTA 80/85	8,0	176	396	1,3	26	MRS-MRT 110	14	100	458	1,0	48
MRA-MTA 80/85	5,5	252	520	1,0	26	MRA-MTA 80/110	11	126	671	1,6	52
MRA-MTA 8 0/110	4,6	309	614	1,8	49	MRA-MTA 80/110	8,0	176	832	1,4	52
MRA-MTA 80/110	4,0	353	689	1,4	49	MRA-MTA 80/110	5,5	252	1078	1,0	52
MRS-MRT 50 / 110	3,3	420	756	1,1	49	MRA-MTA 80/110	4,6	309	1229	0,9	52
MRA-MTA 80/110	3,2	441	794	1,2	49	MRA 110/130	3,5	400	1681	1,0	94
MRA-MTA 80/110	2,8	504	851	0,9	49	MRS-MRT 60 / 130	3,3	420	1576	1,3	69
MRS-MRT 50 / 110	2,5	570	962	1,3	49	MRA 110/150	3,0	448	1916	1,3	99
MRS-MRT 50 / 110	1,8	784	1235	1,5	49	MRA 110/150	2,5	560	2059	1,0	99
						MRA 110/150	2,2	640	2209	0,9	99
						MRS-MRT 70 / 150	1,8	784	2706	0,9	102
0,75 kW						1,5 kW					
	rpm	i =	Nm	SF	kg		rpm	i =	Nm	SF	kg
MRS-MRT 50	200	5	23	>3	14	MRS-MRT 60	280	5	46	2,7	20
MRS-MRT 50	200	7	31	2,4	14	MRS-MRT 60	200	7	62	1,8	20
MRS-MRT 50	140	10	43	1,7	14	MRS-MRT 60	140	10	86	1,5	20
MRS-MRT 50	93	15	60	1,2	14	MRS-MRT 60	93	15	124	1,0	20
MRS-MRT 60	70	20	79	1,5	17	MRS-MRT 60	70	20	166	1,2	23
MRS-MRT 60	50	28	102	1,4	17	MRS-MRT 70	70	20	166	1,2	23
MRS-MRT 60	35	40	135	1,0	17	MRS-MRT 70	50	28	215	1,0	23
MRA-MTA 80/60	32	44	178	1,2	20	MRS-MRT 85	35	40	295	1,4	27
MRS-MRT 70	29	49	168	1,1	19	MRA-MTA 80 / 85	32	44	360	1,4	31
MRS-MRT 70	25	56	183	1,0	19	MRS-MRT 85	29	49	336	0,9	27
MRA-MTA 80/60	22	63	242	1,0	20	MRS-MRT 110	29	49	356	1,8	50
MRS-MRT 85	20	70	226	1,3	23	MRS-MRT 110	25	56	401	1,5	50
MRS-MRT 85	18	80	246	1,1	23	MRA-MTA 80 / 85	22	63	496	1,1	31
MRA-MTA 8 70	11	126	341	0,9	23	MRS-MRT 110	20	70	480	1,3	50
MRA-MTA 80/85	8,0	176	540	0,9	27	MRS-MRT 110	18	80	540	1,0	50
MRA-MTA 80/110	5,5	252	735	1,5	50	MRA-MTA 80/110	15	95	719	1,6	54
MRA-MTA 80/110	4,6	309	838	1,3	50	MRS130	14	100	624	1,2	64
MRA-MTA 80/110	4,0	353	939	1,1	50	MRA-MTA 80/110	11	126	915	1,2	54
MRS-MRT 50 / 110	3,3	420	1031	1,2	50	MRA-MTA 80/110	8,0	176	1135	1,0	54
MRA-MTA 80/110	3,2	441	1083	0,9	50	MRA100/130	7,0	200	1269	1,0	71
MRS-MRT 50 / 110	2,5	570	1289	1,0	50	MRA100/130	6,3	224	1421	1,2	71
1,1 kW						MRA100/150					
	rpm	i =	Nm	SF	kg		rpm	i =	Nm	SF	kg
MRS-MRT 60	200	5	34	>3	19	MRA100/150	5,0	280	1490	1,1	101
						MRA100/150	3,5	400	2292	1,1	101

# RS-RT Riduttori - Gearboxes - Getriebe

# MRS-MRT

Tabella selezione - Selection table - Auswahltable

(1400 rpm)

<b>1.5 kW</b>						<b>4 kW</b>					
	rpm	i =	Nm	SF	kg		rpm	i =	Nm	SF	kg
MRA110/150	3,0	448	2613	1,0	106	MRS-MRT 110	70	20	453	1,4	65
						MRS-MRT 110	50	28	581	1,1	65
<b>2,2 kW</b>						<b>5,5 kW</b>					
	rpm	i =	Nm	SF	kg		rpm	i =	Nm	SF	kg
MRS-MRT 70	280	5	92	1,9	28	MRS130	35	40	829	1,4	79
MRS-MRT 70	200	7	92	1,8	28	MRS130	29	49	963	1,0	79
MRS-MRT 70	140	10	129	1,4	28	MRS130	25	56	1085	0,9	79
MRS-MRT 70	93	15	187	1,0	28	MRS150	25	56	1115	1,3	109
MRS-MRT 85	70	20	246	1,3	33	MRS150	20	70	1299	0,9	109
MRS-MRT 85	50	28	319	1,0	33	MRA100/130	20	70	1433	0,9	86
MRS-MRT 110	35	40	438	1,6	55	MRA100/150	18	80	1724	0,9	116
MRS-MRT 110	29	49	522	1,2	55	MRA100/150	14	98	1845	1,2	116
MRS-MRT 110	25	56	588	1,0	55	MRA100/150	12	120	2456	0,9	116
MRS-MRT 110	20	70	704	0,9	55						
MRS130	18	80	756	1,1	69	MRS-MRT 110	200	7	231	2,3	79
MRS150	14	100	945	1,2	99	MRS-MRT 110	140	10	326	1,6	79
MRA100/130	14	98	985	1,5	78	MRS-MRT 110	93	15	473	1,2	79
MRA100/130	12	125	1369	1,3	78	MRS-MRT 110	70	20	623	1,0	79
MRA100/130	10	140	1324	1,0	78	MRS130	50	28	809	1,4	93
MRA100/130	8,9	160	1729	1,0	78	MRS130	35	40	1141	1,0	93
MRA100/150	7,0	200	1861	1,1	108	MRS150	29	49	1342	1,1	123
MRA100/150	6,3	230	2175	1,2	108	MRS150	25	56	1534	0,9	123
<b>3 kW</b>						<b>7,5 kW</b>					
	rpm	i =	Nm	SF	kg		rpm	i =	Nm	SF	kg
MRS-MRT 70	280	5	91	1,9	30	MRS-MRT 110	200	7	315	1,7	88
MRS-MRT 70	200	7	126	1,3	30	MRS-MRT 110	140	10	445	1,2	88
MRS-MRT 70	140	10	176	1,0	30	MRS-MRT 110	93	15	645	0,9	88
MRS-MRT 85	93	15	255	1,1	35	MRS130	93	15	652	1,5	102
MRS-MRT 85	70	20	336	1,1	35	MRS 130	70	20	860	1,1	102
MRS-MRT 110	50	28	435	1,5	57	MRS130	50	28	1103	1,0	102
MRS-MRT 110	35	40	598	1,2	57	MRS150	35	40	1576	1,1	132
MRS-MRT 110	29	49	712	0,9	57						
MRS130	29	49	722	1,3	71	<b>11 kW</b>					
MRS130	25	56	814	1,2	71		rpm	i =	Nm	SF	kg
MRS150	20	70	974	1,3	101	MRS150	200	7	467	2,3	148
MRA100/130	20	70	1074	1,3	78	MRS150	140	10	660	1,9	148
MRS150	18	80	1064	1,1	101	MRS150	93	15	968	1,5	148
MRA100/130	18	80	1277	1,0	78	MRS150	70	20	1261	1,1	148
MRA100/130	14	98	1344	1,1	78	<b>15 kW</b>					
MRS150	14	100	1289	0,9	101		rpm	i =	Nm	SF	kg
MRA100/130	12	120	1793	1,0	78	MRS150	200	7	637	1,7	158
MRA100/150	10	140	1891	1,1	108	MRS150	140	10	900	1,4	158
MRA100/150	8,9	160	2357	1,1	108	MRS150	93	15	1320	1,1	158
<b>4kW</b>											
	rpm	i =	Nm	SF	kg						
MRS-MRT 85	280	5	122	2,3	43						
MRS-MRT 85	200	7	168	1,5	43						
MRS-MRT 85	140	10	235	1,1	43						
MRS-MRT 110	93	15	344	1,6	65						

## Getriebe - Gearboxes - Riduttori RS-RT

Motorkurzreferenz Tabelle - Motor Quick-Reference Chart - Tabella di Riferimento Rapido Motori

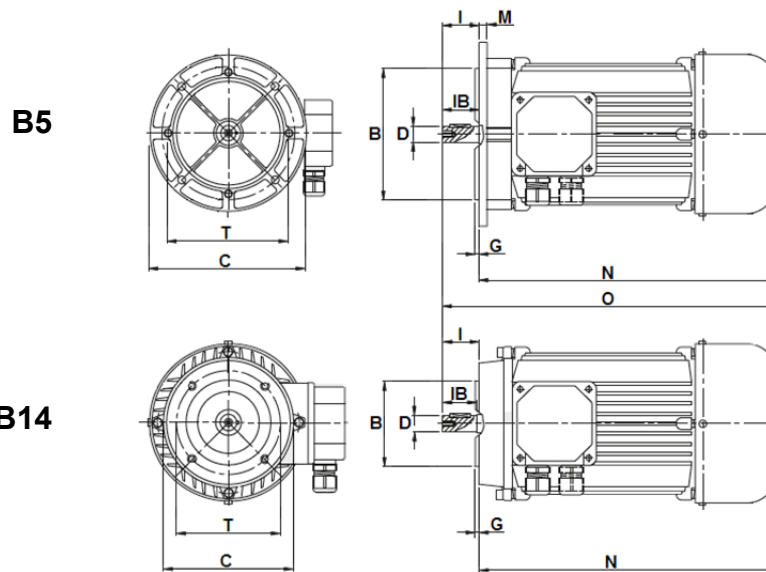

Taglia Size Größe	4 poli / poles / Polen			2 poli / poles / Polen			Flangia Flange Flansch  C / T / B	Albero Shaft Welle  D x l	G	IB	M	N	O
	kW	rpm	kg (B3)	kW	rpm	kg (B3)							
T56A	0.06	1410	2.5	0.09	2730	2.6	B5 - 120 / 100 / 80	9 x 20	2.5	20	8.5	168	188
T56B	0.09	1340	2.6	0.14	2750	3.2	B14 - 80 / 65 / 50					125	145
T63A	0.13	1340	3.7	0.18	2770	3.7	B5 - 140 / 115 / 95	11 x 23	2.5	23	10	190.5	213.5
T63B	0.18	1360	4.3	0.25	2820	4.3	B14 - 90 / 75 / 60					140	161
T71A	0.25	1410	5.8	0.37	2860	5.8	B5 - 160 / 130 / 110	14 x 30	3.0	30	10	218	248
T71B	0.37	1370	6.2	0.55	2860	6.2	B14 - 105 / 85 / 70					168	188
T80A	0.55	1430	8.5	0.75	2860	8.5	B5 - 200 / 165 / 130	19 x 40	3.0	40	11	248	282
T80B	0.75	1430	9.8	1.1	2850	9.8	B14 - 120 / 100 / 80						
T90S	1.1	1430	12.0	1.5	2880	12.0	B5 - 200 / 165 / 130	24 x 50	3.5	50	10	255	305
T90L	1.5	1430	13.5	2.2	2850	13.5	B14 - 140 / 115 / 95					280	330
T100A	2.2	1430	19.0	3	2910	18.5	B5 - 250 / 215 / 180	28 x 60	4.0	60	14	312	372
T100B	3	1430	21.0	4	2920	21.0	B14 - 160 / 130 / 110						
T112A	4	1440	29.0	5.5	2920	32.0	B5 - 250 / 215 / 180 B14 - 160 / 130 / 110	28 x 60	4.0	60	14	330	390
T132S	5.5	1460	43	7.5	2920	48	B5 - 300 / 265 / 230	38 x 80	4.0	80	20	380.5	460.5
T132M	7.5	1460	52	11	2940	54	B14 - 200 / 165 / 130					418.5	498.5
T132ML	9.2	1460	54	15	2940	58							
T160M	11	1470	90	---	---	---	B5 - 350 / 300 / 250	42 x 110	4.0	110	20	491	601
T160L	15	1480	100	18.5	2960	99	B14 - 250 / 215 / 180					535	645

Dimensioni e pesi non impegnativi

Not binding dimensions and weights

unverbindliche Abmessungen u. Gewichte



# RS

# Getriebe - Gearboxes - Riduttori RS-RT

Abmessungen - Overall dimensions - Dimensioni di ingombro

RS	28	40	50	60	70	85	110	130	150
A	70	100	120	138	158	193	250	286	336
A <sub>1</sub>	52	70	85	95	120	140	200	235	260
AA	99	138	163	192	221	252	333	400	454
B	78	102	119	136	#	168	200	230	250
B <sub>1</sub>	66	84	99	111	116	140	162	190	210
C	30	41	49	60	60	61	77,5	90	105
C <sub>1</sub>	26,5	26	30,5	39	37,5	38,5	52,5	85	100
D <sup>(H7)</sup>	14	18-19-20	24-25	25	25-28-30	32-35	42	48	55
D <sub>2</sub> <sup>(h6)</sup>	9	11	14	19	19	24	28	38	42
E	34	50	61	70	80	98	125	143	168
F	70	140	160	180	200	200	250	300	350
F <sub>1</sub>	5,5	7	9	11	11	13	14	15	19
G <sup>(H8)</sup>	40	95	110	115	130	130	180	230	250
G <sub>1</sub> <sup>(f8)</sup>	42	60	70	70	80	110	130	180	180
H	52	71	85	100	115	135	172	200	230
H <sub>1</sub>	47	67	78	92	106	117	161	200	224
H <sub>2</sub>	9	15	17,5	21,5	19	26,5	25	25,5	38
H <sub>4</sub>	40	50	60	72	86	103	139	159	183
I	28	40	50	60	70	85	110	130	150
K	57,5	70,5	83-88*	93-94*	117-118*	134-137*	151-153*	173	191-211*
L	20	23	30	40	40	50	60	80	100
M	50	65	75	87	110	123,5	146	166	195
M <sub>1</sub>	16,3	21,8	27,3	28,3	31,3	35,3	45,3	51,8	59,3
M <sub>2</sub>	10,2	12,5	16	22,5	22,5	27	31	41	45
N <sub>1</sub>	5	6	8	8	8	10	12	14	16
N <sub>2</sub>	3	4	5	6	6	8	8	10	12
O	37	52	60	70	70	80	90	120	120
O <sub>1</sub>	2,5	3,5	3,5	4,75	4,75	5	6	9	9
P	49	82	91,5	116	111	100	150	150	160
P <sub>1</sub>	67	94	100	102	118	150	200	234	250
P <sub>2</sub>	19	41	42,5	56	51	39	72,5	60	55
Q	30°	60°	55°	60°	60°	60°	60°	60°	60°
R	56	115	130	150	165	165	215	265	300
R <sub>1</sub>	56	83	85	85	100	130	165	215	215
S	32	38	49	57,5	57	56,5	74,5	87	102
S <sub>1</sub>	6	9	12	12	14	15	17	19	20
S <sub>2</sub>	-3	2	2,5	2,5	3	3	2,5	5	5
U	4	6	10	10	12	6	5	5	6
V	6,5 (4)	9 (4)	9 (4)	11 (4)	13 (4)	13 (4)	15 (8)	15 (8)	19 (8)
V <sub>1</sub>	M6x6 (4)	M6x9 (4)	M8x12 (4)	M8x15 (8)	M8x18 (8)	M10x20 (8)	M12x21 (8)	M12x24 (8)	M14x30 (8)
V <sub>2</sub>	M4x10	M4x10	M6x15	M8x20	M8x20	M8x20	M8x20	M10x22	M12x25
Y <sub>1</sub>	47	61	70	80	85	100	106	140	140
Y <sub>2</sub>	M5x8,5 (6)	M5x10 (6)	M6x10 (6)	M6x12 (6)	M8x16 (6)	M8x15 (6)	M8x15,5	M10x20 (6)	M10x20 (6)
Z	6	10	10	11	14	14	16	22	20

\* - IEC71-B14 (FRS50) - IEC71-B14 (FRS60) - IEC 80-B14 (FRS70) - IEC 90-B14 (FRS85) - IEC100/112-B14 (FRS110)  
- IEC 100/112-B5 (FRS130) - IEC 160-B5 (FRS150)

# - 137 - Versione piedi riportati (std)  
- 142 - Versione piedi integrali

Dimensioni motore: vedi pag, 33

Dimensioni non impegnative

**Nota:** le dimensioni L, M, O, O<sub>1</sub>, Y<sub>1</sub>, Y<sub>2</sub> si riferiscono anche all'entrata SRS

# - 137 - Bolted feet version (std)  
- 142 - Integral feet version

Motor dimensions: see page 33

Not binding dimensions

**Note:** dimensions L, M, O, O<sub>1</sub>, Y<sub>1</sub>, Y<sub>2</sub> also apply to SRS input

# - 137 - geschraubt Füße Ausführung Std  
- 142 - integral Füße Ausführung

Abmessungen Motor: siehe Seite 33

unverbindliche Abmessungen

**Anmerkung:** die Abmessungen L, M, O, O<sub>1</sub>, Y<sub>1</sub>, Y<sub>2</sub> entsprechen auch die SRS-Eingang

**RS-RT Riduttori - Gearboxes - Getriebe**

**RA**

Con precoppia - Helical/worm - mit Stirnradvorstufe

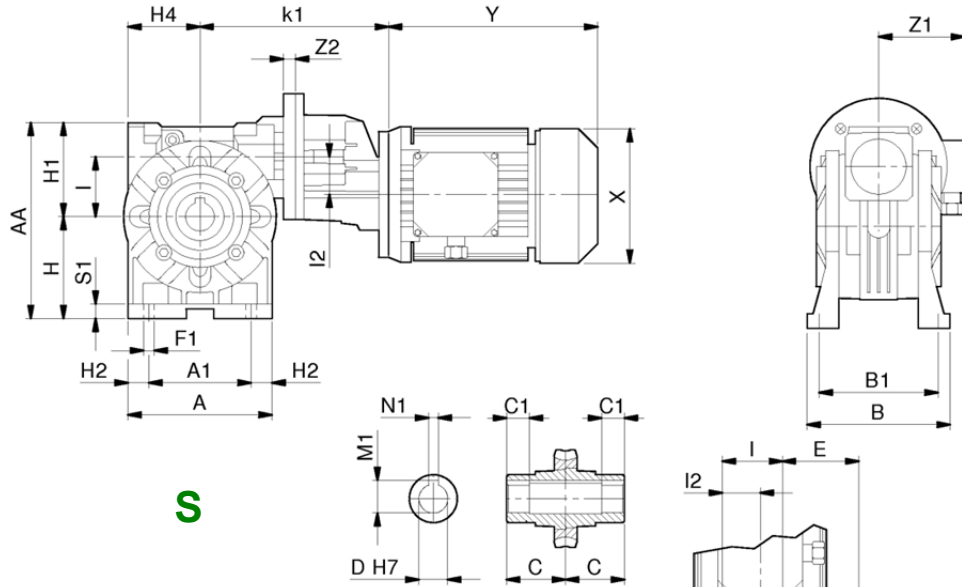

**S**

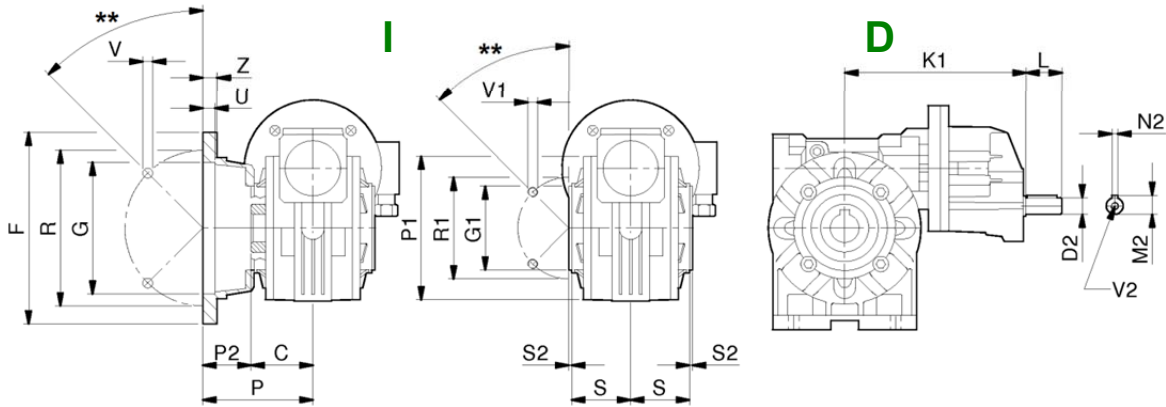
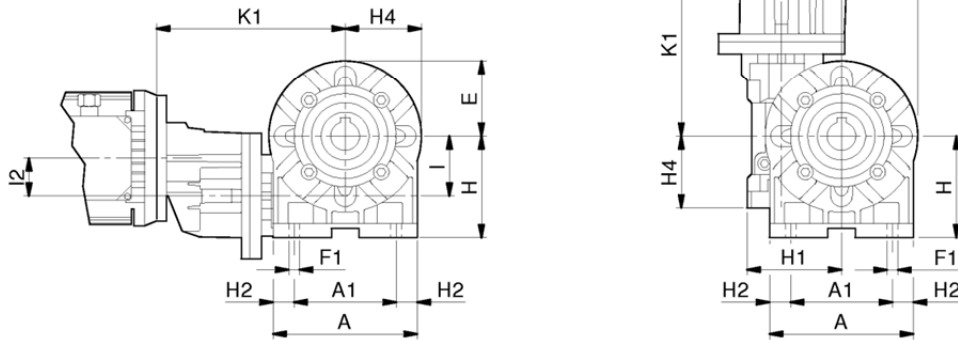

**FL**

**PC**

**RA**

# RA

# Getriebe - Gearboxes - Riduttori RS-RT

Abmessungen - Overall dimensions - Dimensioni di ingombro

RA	63/40	63/50	63/60	71/50	71/60	71/70	71/85	80/60	80/70	80/85	80/110	100/110	100/130	100/150
A	100	120	138	120	138	158	193	138	158	193	250	250	286	336
A <sub>1</sub>	70	85	95	85	95	120	140	95	120	140	200	200	235	260
AA	138	163	192	163	192	221	252	192	221	252	333	333	400	454
B	102	119	136	119	136	#	168	136	#	168	200	200	230	250
B <sub>1</sub>	84	99	111	99	111	116	140	111	116	140	162	162	190	210
C	41	49	60	49	60	60	61	60	60	61	77,5	77,5	90	105
C <sub>1</sub>	26	30,5	39	30,5	39	37,5	38,5	39	37,5	38,5	52,5	52,5	85	100
D <sub>(H7)</sub>	18-19- 20	24-25 ---	25 ---	24-25 ---	25 ---	25-28- 30	32 35	25 ---	25-28 30	32-35 ---	42 ---	42 ---	48 ---	55 ---
D <sub>2</sub>	11	11	11	14	14	14	14	19	19	19	19	24	24	24
E	50	61	70	61	70	80	98	70	80	98	125	125	143	168
F	140	160	180	160	180	200	200	180	200	200	250	250	300	350
F <sub>1</sub>	7	9	11	9	11	11	13	11	11	13	14	14	15	19
G	95	110	115	110	115	130	130	115	130	130	180	180	230	250
G <sub>1</sub>	60	70	70	70	70	80	110	70	80	110	130	130	180	180
H	71	85	100	85	100	115	135	100	115	135	172	172	200	230
H <sub>1</sub>	67	78	92	78	92	106	117	92	106	117	161	161	200	224
H <sub>2</sub>	15	17,5	21,5	17,5	21,5	19	26,5	21,5	19	26,5	25	25	25,5	38
H <sub>4</sub>	50	60	72	60	72	86	103	72	86	103	139	139	159	189
I	40	50	60	50	60	70	85	60	70	85	110	110	130	150
I <sub>2</sub>	32	32	32	40	40	40	40	50	50	50	50	63	63	63
K <sub>1</sub>	153,5 ---	171 ---	177 ---	173 178*	183 188*	209 214*	224 229*	207 ---	232,5 ---	250,5 ---	264,5 ---	328 ---	342 ---	368 ---
L	23	23	23	30	30	30	30	40	40	40	40	50	50	50
M <sub>1</sub>	21,8	27,3	28,3	27,3	28,3	31,3	35,3	28,3	31,3	35,3	45,3	45,3	51,8	59,3
M <sub>2</sub>	12,5	12,5	12,5	16	16	16	16	22,5	22,5	22,5	22,5	27	27	27
N <sub>1</sub>	6	8	8	8	8	8	10	8	8	10	12	12	14	16
N <sub>2</sub>	4	4	4	5	5	5	5	6	6	6	6	8	8	8
P	82	91,5	116	91,5	116	111	100	116	111	100	150	150	150	160
P <sub>1</sub>	94	100	102	100	102	118	150	102	118	150	200	200	234	250
P <sub>2</sub>	41	42,5	56	42,5	56	51	39	56	51	39	72,5	72,5	60	55
R	115	130	150	130	150	165	165	150	165	165	215	215	265	300
R <sub>1</sub>	83	85	85	85	85	100	130	85	100	130	165	165	215	215
S	38	49	57,5	49	57,5	57	56,5	57,5	57	56,5	74,5	74,5	87	102
S <sub>1</sub>	9	12	12	12	12	14	15	12	14	15	17	17	19	20
S <sub>2</sub>	2	2,5	2,5	2,5	2,5	3	3	2,5	3	3	2,5	2,5	5	5
U	6	10	10	10	10	12	6	10	12	6	5	5	5	6
V	9	9	11	9	11	13	13	11	13	13	15	15	15	19
V <sub>1</sub>	(4) M6x9	(4) M8x12	(4) M8x15	(4) M8x12	(4) M8x15	(4) M8x18	(4) M10x20	(4) M8x15	(4) M8x18	(4) M10x20	(8) M12x21	(8) M12x21	(8) M12x24	(8) M14x30
V <sub>2</sub>	M4x10	M4x10	M4x10	M6x15	M6x15	M6x15	M6x15	M8x20	M8x20	M8x20	M8x20	M8x20	M8x20	M8x20
Y <sub>1</sub>	105	105	105	120	120	120	120	140	140	140	140	140	200	200
Z	10	10	11	10	11	14	14	11	14	14	16	16	22	20

\* - IEC71-B14 (FRA 71/50, FRA 71/60, FRA 71/70, FRA 71/85) - IEC100-B5 (FRA 100/130) - IEC100-B5 (FRA 100/150)

\*\* - 90° per RS28 / 45° per altri tipi

\*\* - 90° for RS28 / 45° for other sizes

\*\* - 90° für RS28 / 45° für die andere Type

# - 137 - Piedi riportati (std)

# - 137 - Bolted feet version (std)

# - 137 - geschraubt Füße Ausführung Std

- 142 - Piedi integrali

- 142 - Integral feet version

- 142 - integral Füße

Dimensioni motore: vedi pag. 33

Motor dimensions: see page 33

Abmessungen Motor: siehe Seite 33

Dimensioni non impegnative

Not binding dimensions

unverbindliche Abmessungen

# RS-RT Riduttori - Gearboxes - Getriebe

# RS/RS

Doppio stadio - Two stages - Doppelstufige

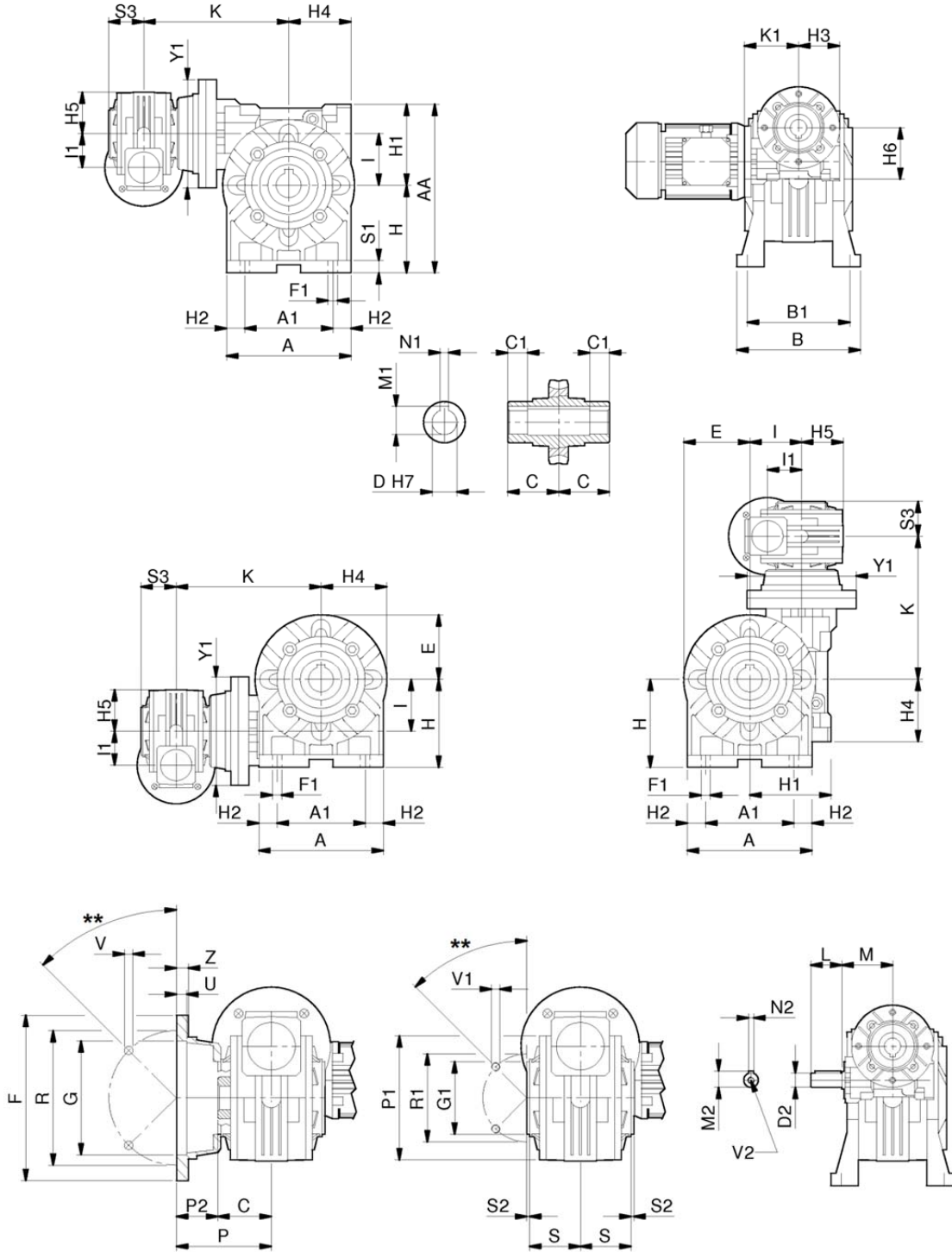



# RS/RS

# Getriebe - Gearboxes - Riduttori RS-RT

Abmessungen - Overall dimensions - Dimensioni di ingombro

RS/RS	28/28	28/40	28/50	28/60	40/70	40/85	50/110	60/130	70/150
A	70	100	120	138	158	193	250	286	336
A <sub>1</sub>	52	70	85	95	120	140	200	235	260
AA	99	138	163	192	221	252	333	400	454
B	78	102	119	136	#	168	200	230	250
B <sub>1</sub>	66	84	99	111	116	140	162	190	210
C	30	41	49	60	60	61	77,5	90	105
C <sub>1</sub>	26.5	26	30.5	39	37.5	38.5	52.5	85	100
D <sup>(H7)</sup>	14	18-19-20	24-25	25	25-28-30	32-35	42	48	55
D <sub>2</sub> <sup>(h6)</sup>	9	9	9	9	11	11	14	38	42
E	34	50	61	70	80	98	125	143	168
F	70	140	160	180	200	200	250	300	350
F <sub>1</sub>	5,5	7	9	11	11	13	14	15	19
G <sup>(H8)</sup>	40	95	110	115	130	130	180	230	250
G <sub>1</sub> <sup>(f8)</sup>	42	60	70	70	80	110	130	180	180
H	52	71	85	100	115	135	172	200	230
H <sub>1</sub>	47	67	78	92	106	117	161	200	224
H <sub>2</sub>	9	15	17,5	21,5	19	26,5	25	25,5	38
H <sub>3</sub>	40	40	40	40	50	50	60	72	86
H <sub>4</sub>	40	50	60	72	86	103	139	159	189
H <sub>5</sub>	34	34	34	34	50	50	61	70	80
H <sub>6</sub>	47	47	47	47	67	67	78	92	106
I	28	40	50	60	70	85	110	130	150
I <sub>2</sub>	28	28	28	28	40	40	50	60	70
K	99,5	123	138,5	146	182	199	246	246	300
K <sub>1</sub>	57,5	57,5	57,5	57,5	70,5	70,5	83 - 88*	93 - 94*	117-118*
L	20	20	20	20	23	23	30	40	40
M	50	50	50	50	65	65	75	87	110
M <sub>1</sub>	16,3	21,8	27,3	28,3	31,3	35,3	45,3	51,8	59,3
M <sub>2</sub>	10,2	10,2	10,2	10,2	12,5	12,5	16	22,5	22,5
N <sub>1</sub>	5	6	8	8	8	10	12	14	16
N <sub>2</sub>	3	3	3	3	4	4	5	6	6
P	49	82	91,5	116	111	100	150	150	160
P <sub>1</sub>	67	94	100	102	118	150	200	234	250
P <sub>2</sub>	19	41	42,5	56	51	39	72,5	60	55
R	56	115	130	150	165	165	215	265	300
R <sub>1</sub>	56	83	85	85	100	130	165	215	215
S	32	38	49	57,5	57	56,5	74,5	87	102
S <sub>1</sub>	6	9	12	12	14	15	17	19	20
S <sub>2</sub>	-3	2	2,5	2,5	3	3	2,5	5	5
S <sub>3</sub>	30	30	30	30	41	41	49	60	60
U	4	6	10	10	12	6	5	5	6
V	6,5 (4)	9 (4)	9 (4)	11 (4)	13 (4)	13 (4)	15 (8)	15 (8)	19 (8)
V <sub>1</sub>	M6x6 (4)	M6x9 (4)	M8x12 (4)	M8x15 (8)	M8x18 (8)	M10x20 (8)	M12x21 (8)	M12x24 (8)	M14x30 (8)
V <sub>2</sub>	M4x10	M4x10	M4x10	M4x10	M4x10	M4x10	M6x15	M8x20	M8x20
Y <sub>1</sub>	80	80	80	90	115	115	110	180	200
Z	6	10	10	11	14	14	16	22	20

\* - IEC71-B14 (FRS50) - IEC71-B14 (FRS60) - IEC 80-B14 (FRS70)

\*\* - 90° per RS28 / 45° per altri tipi

# - 137 - Piedi riportati (std)  
- 142 - Piedi integrali

Dimensioni motore: vedi pag. 33  
Dimensioni non impegnative

- 90° for RS28 / 45° for other sizes

- 137 - Bolted feet (std)  
- 142 - Integral feet

Motor dimensions: see page 33  
Not binding dimensions

- 90° für RS28 / 45° für die andere Type

- 137 - geschraubt Füße Ausführung (Std)  
- 142 - integral Füße Ausführung

Abmessungen Motor: siehe Seite 33  
unverbindliche Abmessungen

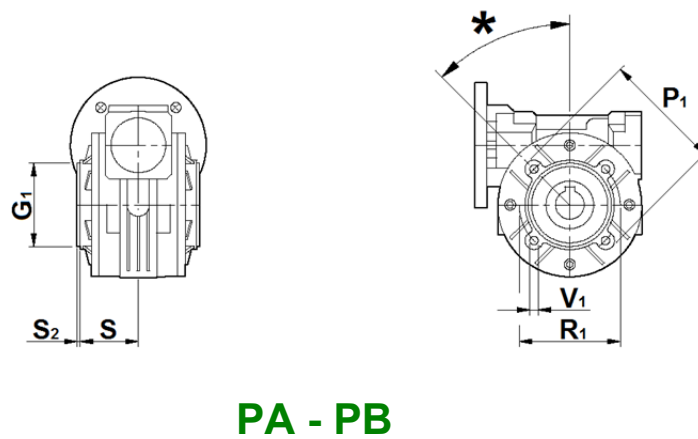
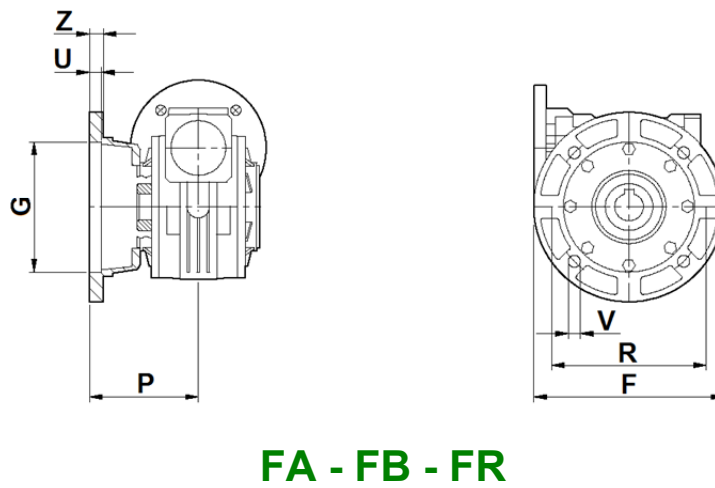
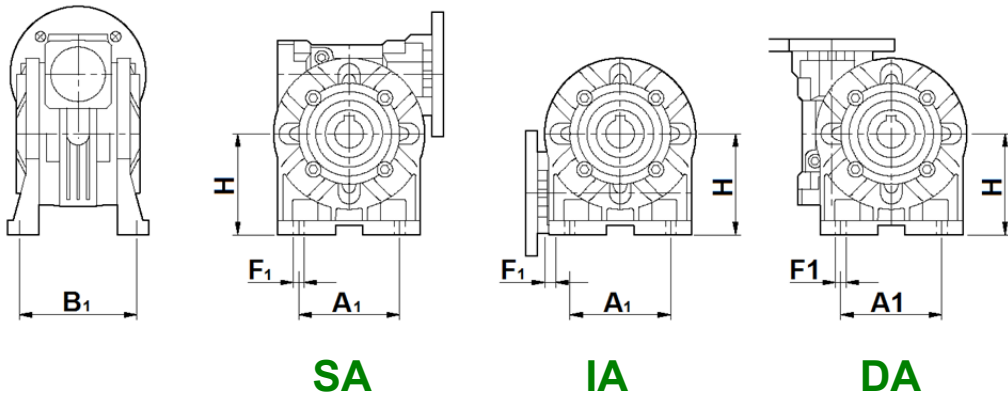

# RS

# Getriebe - Gearboxes - Riduttori RS-RT

Abmessungen - Overall dimensions - Dimensioni di ingombro

RS	28	40	50	60	70	85	110	130	150
<b>SA - IA - DA</b>									
A <sub>1</sub>	---	52	63	---	---	140	---	---	---
B <sub>1</sub>	---	81	98,5	---	---	146	---	---	---
F <sub>1</sub>	---	8,5	9	---	---	11	---	---	---
H	---	72	82	---	---	142	---	---	---
<b>FA</b>									
F	80	114	125	165	165	---	---	---	---
G <sub>(H8)</sub>	50	60	70	110	115	---	---	---	---
P	50,5	69	93	90	116	---	---	---	---
R	68	87	90	130	150	---	---	---	---
U	3,5	5	5	10	4,5	---	---	---	---
V	6,5 (4)	9 (4)	11 (4)	10,5 (4)	11 (4)	---	---	---	---
Z	7	8	10	15	10	---	---	---	---
<b>FB</b>									
F	---	120	---	180	---	210	270	---	---
G <sub>(H8)</sub>	---	80	---	115	---	152	170	---	---
P	---	62	---	86	---	119,5	131,5	---	---
R	---	100	---	150	---	176	230	---	---
U	---	4	---	3,5	---	5	5	---	---
V	---	9 (4)	---	11 (4)	---	11 (4)	13 (4)	---	---
Z	---	9	---	12	---	14	18	---	---
<b>FR</b>									
F	---	---	---	---	160	---	---	---	---
G <sub>(H8)</sub>	---	---	---	---	110	---	---	---	---
P	---	---	---	---	84,5	---	---	---	---
R	---	---	---	---	130	---	---	---	---
U	---	---	---	---	4,5	---	---	---	---
V	---	---	---	---	11 (4)	---	---	---	---
Z	---	---	---	---	14	---	---	---	---
<b>PA</b>									
G <sub>1 (H8)</sub>	---	50	68	75	90	---	---	---	---
P <sub>1</sub>	---	95	110	104	125	---	---	---	---
R <sub>1</sub>	---	65	94	90	110	---	---	---	---
S	---	38	49	47,5	55	---	---	---	---
S <sub>2</sub>	---	2	2,5	5,5	3	---	---	---	---
V <sub>1</sub>	---	M6x8 (4)	M6x12,5(4)	M8x14 (4)	M8x14 (4)	---	---	---	---
<b>PB</b>									
G <sub>1 (H8)</sub>	---	---	60	---	70	---	---	---	---
P <sub>1</sub>	---	---	110	---	116	---	---	---	---
R <sub>1</sub>	---	---	75	---	85	---	---	---	---
S	---	---	49	---	67	---	---	---	---
S <sub>2</sub>	---	---	2,5	---	4	---	---	---	---
V <sub>1</sub>	---	---	M6x12,5(4)	---	M8x14 (4)	---	---	---	---

\* - 45° std / 90° su richiesta  
Dimensioni non impegnative

\* - 45° std / 90° on demand  
Not binding dimensions

\* - 45° std. / 90° auf Anfrage  
unverbindliche Abmessungen

**AS**

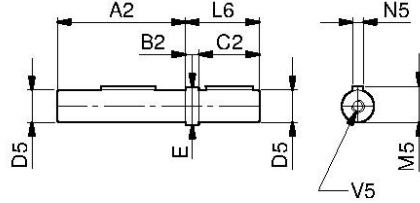

**AD**

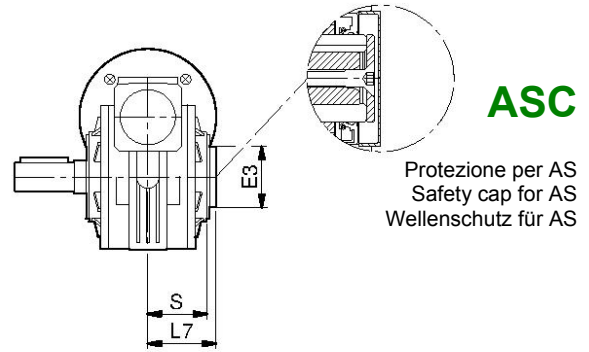
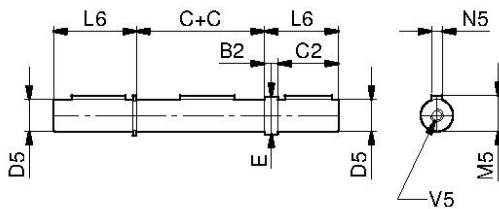

**ASC**  
 Protezione per AS  
 Safety cap for AS  
 Wellenschutz für AS

**BR**

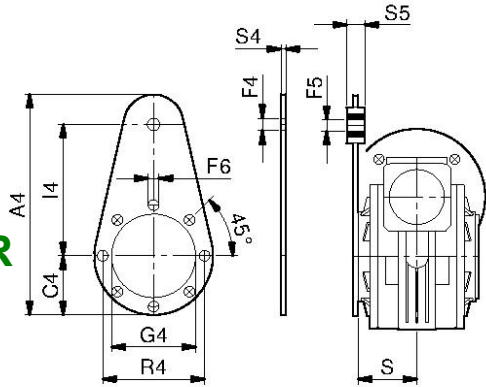

**BRV**

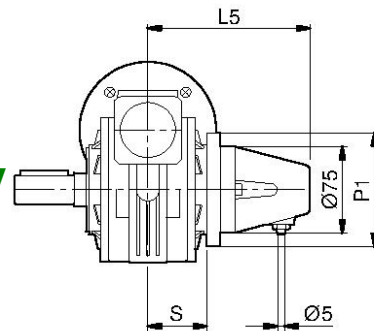

**SL**

**TLE**

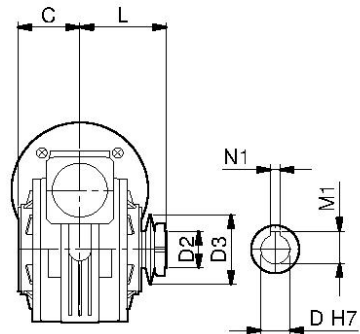
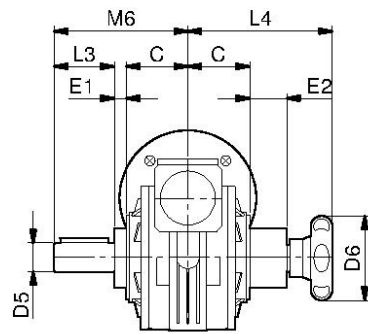

**TLI**

**VB**

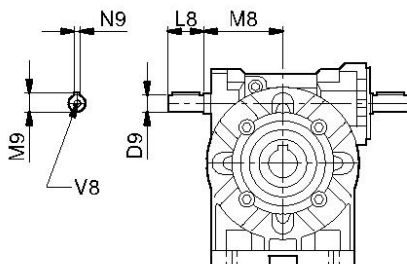

**TLI**  
**Olio - Oil - Öl**  
 Litri / Litres / Liter

RS 28	0.04
RS 40	0.10
RS 50	0.13
RS 60	0.30
RS 70	0.45
RS 85	0.75
RS 110	2.25

# RS

# Getriebe - Gearboxes - Riduttori RS-RT

Abmessungen - Overall dimensions - Dimensioni di ingombro

RS	28	40	50	60	70	85	110	130	150
<b>AS &amp; AD</b> A <sub>2</sub>	58	80	95	117	117	119	153	177	207
B <sub>2</sub>	1	10	10	10	10	10	10	20	20
C	30	41	49	60	60	61	77,5	90	105
C <sub>2</sub>	30	40	45	50	60	70	100	110	110
D <sub>5</sub> (g6)	14	19 (18)	24 (25)	25	28	32 (35)	42	48	55
E	14	22	28	30	34	38	50	58	63
L <sub>6</sub>	31	50	55	60	70	80	110	130	130
M <sub>5</sub>	16	21,5	27	28	31	35	45	51,5	59
N <sub>5</sub> (h9)	5	6	8	8	8	10	12	14	16
V <sub>5</sub>	M5x10	M8x20	M8x20	M8x20	M8x20	M10x25	M10x25	---	---
<b>ASC</b> E <sub>3</sub>	42	55	62	62	72	90	120	---	---
L <sub>7</sub>	36	48,5	55,5	68,5	67	77	85	---	---
S	27,5	38,5	46,5	57	57	67	74	---	---
<b>BR &amp; BRV</b> A <sub>4</sub>	133,5	168	185	230	240	313	388	465	525
C <sub>4</sub>	33,5	43	60	50	60	75	100	120	125
F <sub>4</sub>	10,5	10,5	10,5	10,5	10,5	20,5	20,5	26	26
F <sub>5</sub> (0/+0.4)	10	10	10	10	10	20	20	25	25.2
F <sub>6</sub>	7	7	9	9	9	11	13	13	15
G <sub>4</sub>	42	60	70	70	80	110	130	180	180
I <sub>4</sub>	80	90	100	150	150	200	250	300	350
R <sub>4</sub>	56	83	85	85	100	130	165	215	215
S <sub>4</sub>	4	4	4	6	6	6	6	6	6
S <sub>5</sub>	15	15	15	20	20	25	25	30	30
<b>SL</b> L <sub>5</sub>	97	114	129	137	133	133	151	---	---
P <sub>1</sub>	67	100	110	102	120	150	200	---	---
S	32	38	49	57,5	57	56,5	74,5	---	---
<b>TLE</b> D <sub>6</sub>	52	70	70	70	80	100	100	---	---
E <sub>1</sub>	10	12	12	15	14	19	24	---	---
E <sub>2</sub>	28	37	31	40	46	57	71	---	---
L <sub>3</sub>	30	40	50	50	60	70	80	---	---
L <sub>4</sub>	94	116	118	128	146	168	201	---	---
M <sub>6</sub>	70	93	111	125	134	150	181	---	---
<b>TLI</b> D (H7)	14	18-19	24/25	25	28	32/35	42	---	---
D <sub>2</sub>	14,2 x 20	19,5 x 20,5	24,5 x 28	25,5 x 26	28,5 x 22	32,5 x 27	42,5 x 38,5	---	---
D <sub>3</sub>	40	56	71	71	80	92	125	---	---
L	45	61,5	77	86,5	89	94	112,5	---	---
M <sub>1</sub>	15,4*	21,8	27,3	27,3*	31,3	35,3	45,3	---	---
N <sub>1</sub> (h9)	5	6	8	8	8	10	12	---	---
<b>VB</b> D <sub>9</sub>	9	11	14	19	19	24	28	38	42
L <sub>8</sub>	20	23	30	40	40	50	60	80	100
M <sub>8</sub>	43	55	65	77	84	106,5	145	166	195
M <sub>9</sub>	10,2	12,5	16	22,5	22,5	27	31	41	45
N <sub>9</sub> (h9)	3	4	5	6	6	8	8	10	12
V <sub>8</sub>	M4x10	M4x10	M6x15	M8x20	M8x20	M8x20	M8x20	M10x22	M12x25

\* = Chiavetta ribassata  
D<sub>5</sub>(..) = Diametro a richiesta  
Dimensioni non impegnative

\* = Undersized key  
D<sub>5</sub>(..) = Diameter on demand  
Not binding dimensions

\* = Passfedernut mit geringerer Tiefe  
D<sub>5</sub>(..)= Durchmesser auf Anfrage  
unverbindliche Abmessungen

# RS-RT Riduttori - Gearboxes - Getriebe

**RT**

Vite senza fine - Worm box - Schneckengetriebe

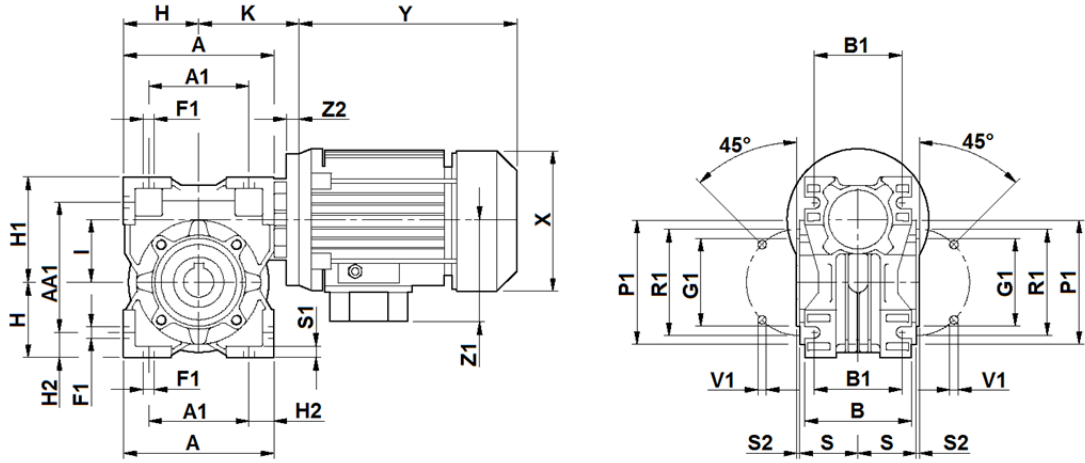

**B3**

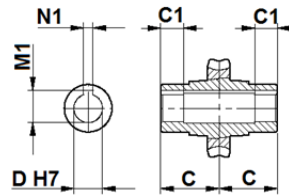

**F, [FV], {FL}**

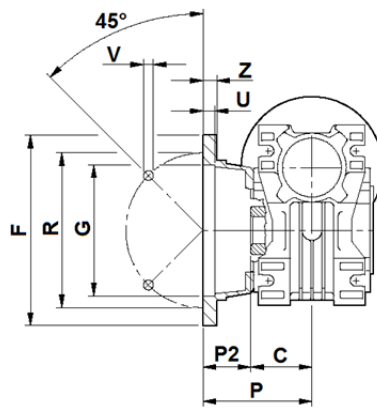

**RT**

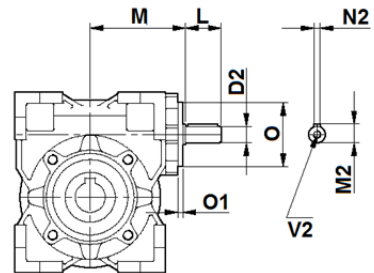
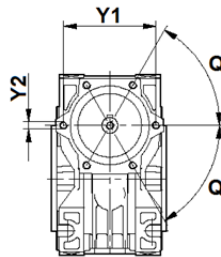
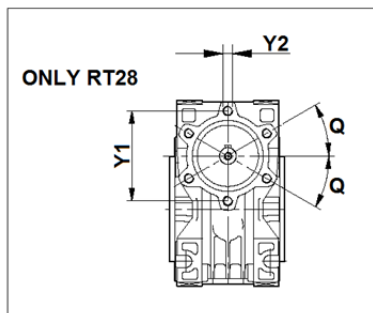

# RT

# Getriebe - Gearboxes - Riduttori RS-RT

Abmessungen - Overall dimensions - Dimensioni di ingombro

RT	28	40	50	60	70	85	110
A	80	100	120	144	172	206	255
A <sub>1</sub>	54	70	80	100	120	140	170
AA	97	121,5	144	174	205	238	295
AA <sub>1</sub>	71	91,5	104	130	153	172	210
B	53	71	85	100	112	130	144
B <sub>1</sub>	44	60	70	85	90	100	115
C	30	41	49	60	60	61	77,5
C <sub>1</sub>	26,5	26	30,5	39	37,5	38,5	52,5
D <sup>(H7)</sup>	14	18-19-20	24-25	25	25-28-30	32-35	42
D <sub>2</sub> <sup>(h6)</sup>	9	11	14	19	19	24	28
F	80	110 {110}	125 [160] 125}	180 {180}	200	210	270
F <sub>1</sub>	7	7	9	9	11	13	15
G <sup>(H8)</sup>	50	60 {60}	70 [110] {70}	115 {115}	130	152	170
G <sub>1</sub> <sup>(h8)</sup>	55	60	70	80	95	110	130
H	40	50	60	72	86	103	127,5
H <sub>1</sub>	57	71,5	84	102	119	135	167,5
H <sub>2</sub>	13	15	20	22	26	33	42,5
I	28	40	50	60	70	85	110
K	57,5	70,5	83-88*	93-94*	117-118*	134-137*	151-153*
L	20	23	30	40	40	50	60
M	50	65	75	87	110	123,5	146
M <sub>1</sub>	16,3	21,8	27,3	28,3	31,3	35,3	45,3
M <sub>2</sub>	10,2	12,5	16	22,5	22,5	27	31
N <sub>1</sub>	5	6	8	8	8	10	12
N <sub>2</sub>	3	4	5	6	6	8	8
O	37	52	60	70	70	80	90
O <sub>1</sub>	2,5	3,5	3,5	4,75	4,75	5	6
P	53	69 {99}	93 [90,5] {123}	86 {116}	111	111	131
P <sub>1</sub>	75	86	100	110	130	160	200
P <sub>2</sub>	23	28 {58}	44 [41,5] {74}	25 {56}	51	50	53,5
Q	30°	60°	55°	60°	60°	60°	60°
R	68	87 {87}	90 [130] {90}	150,5 {150,5}	165	175	230
R <sub>1</sub>	65	75	85	95	115	130	165
S	27,5	38,5	46,5	57	57	67	74
S <sub>1</sub>	6	7	8	10	11	14	13
S <sub>2</sub>	2,5	2,5	3	3	3	3	3,5
U	10	4 {4}	5 [11] {5}	6,5 {6,5}	12	6	5
V	7	9 {9}	11 [9] {9}	11 {11}	13	13	14
V <sub>1</sub>	M6x10 (4)	M6x8,5 (4)	M8x10 (4)	M8x16 (8)	M8x16 (8)	M10x18 (8)	M10x21 (8)
V <sub>2</sub>	M4x10	M4x10	M6x15	M8x20	M8x20	M8x20	M8x20
Y <sub>1</sub>	47	61	70	80	85	100	106
Y <sub>2</sub>	M5x8,5 (6)	M5x10 (6)	M6x10 (6)	M6x10 (6)	M8x16 (6)	M8x15 (6)	M8x15,5 (6)
Z	7	6 {8}	10 [13] {10}	10 {10}	14	16	18
Z <sub>2</sub>	13	13	13 - 18,5	14 - 15	15,5 - 17,5	15,5 - 18,5	18-20

\* - IEC71-B14 (FRT50) - IEC71-B14 (FRT60) - IEC 80-B14 (FRT70) - IEC 90-B14 (FRT85) - IEC100/112-B14 (FRT110)

\*\* - 90° per RS28 / 45° per altri tipi

Dimensioni motore: vedi pag. 33

Dimensioni non impegnative

**Nota:** le dimensioni L, M, O, O<sub>1</sub>, Y<sub>1</sub>, Y<sub>2</sub> si riferiscono anche all'entrata SRT

\*\* - 90° for RS28 / 45° for other sizes

- Motor dimensions: see page 33

- Not binding dimensions

**Note:** dimensions L, M, O, O<sub>1</sub>, Y<sub>1</sub>, Y<sub>2</sub> also apply to SRT input

\*\* - 90° für RS28 / 45° für die andere Type

- Abmessungen Motor: siehe Seite 33

- unverbindliche Abmessungen

**Anmerkung:** die Abmessungen L, M, O, O<sub>1</sub>, Y<sub>1</sub>, Y<sub>2</sub> entsprechen auch dem SRT-Eingang

**RS-RT Riduttori - Gearboxes - Getriebe**

**TA**

Con precoppia - Helical/worm - mit Stirnradvorstufe

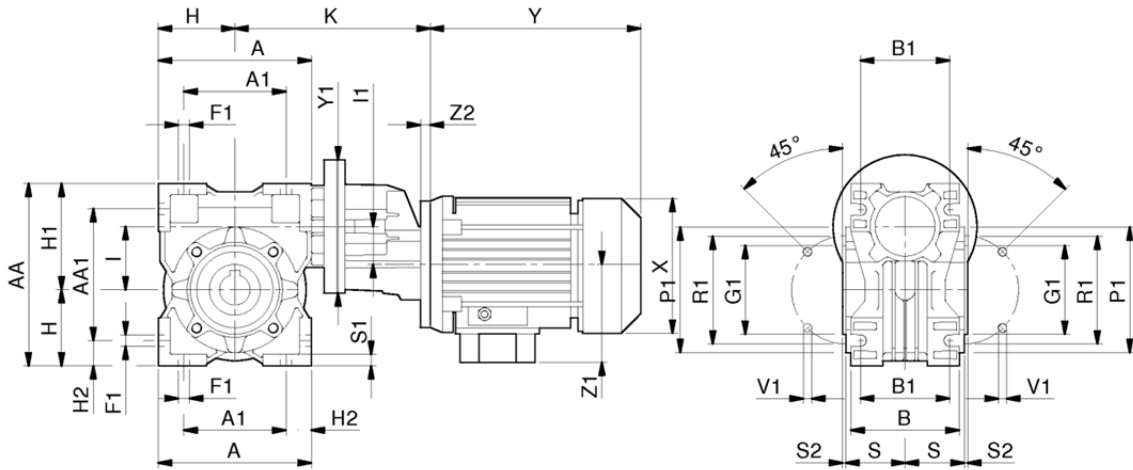

**B3**

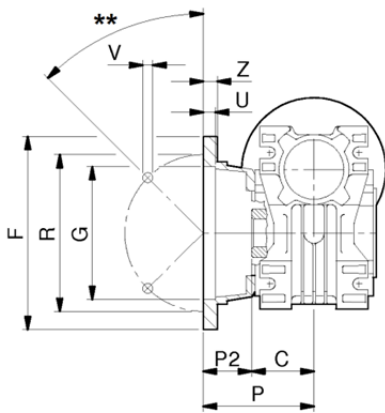
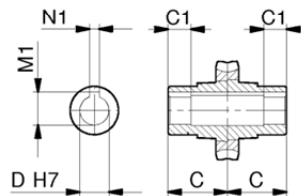

**F, [FV], {FL}**

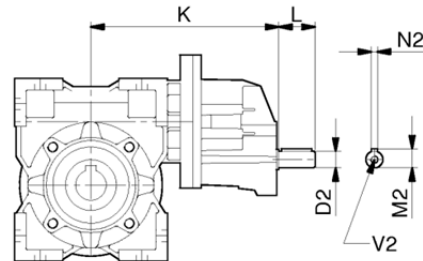

**TA**



# TA

# Getriebe - Gearboxes - Riduttori RS-RT

## Abmessungen - Overall dimensions - Dimensioni di ingombro

TA	63/40	63/50	63/60	71/50	71/60	71/70	71/85	80/60	80/70	80/85	80/110	100/110
A	100	120	144	120	144	172	206	144	172	206	255	255
A <sub>1</sub>	70	80	100	80	100	120	140	100	120	140	170	170
AA	121,5	144	174	144	174	205	238	174	205	238	295	295
AA <sub>1</sub>	91,5	104	130	104	130	153	172	130	153	172	210	210
B	71	85	100	85	100	112	130	100	112	130	144	144
B <sub>1</sub>	60	70	85	70	85	90	100	85	90	100	115	115
C	41	49	60	49	60	60	61	60	60	61	77,5	77,5
C <sub>1</sub>	26	30,5	39	30,5	39	37,5	38,5	39	37,5	38,5	52,5	52,5
D <sub>(H7)</sub>	18-19-	24-25	25	24-25	25	25-28-	32-35	25	25-28-	32-35	42	42
	20	---	---	---	---	30	---	---	30	---	---	---
D <sub>2</sub>	11	11	11	14	14	14	14	19	19	19	19	24
F	110 {110}	125 [160]	180 {180}	125 [160]	180 {180}	200	210	180 {180}	200	210	270	270
	---	{125}	---	{125}	---	---	---	---	---	---	---	---
F <sub>1</sub>	7	9	9	9	9	11	13	9	11	13	15	15
G <sub>(H8)</sub>	60 {60}	70 [110]	115 {115}	70 [110]	115 {115}	130	152	115 {115}	130	152	170	170
	---	{70}	---	{70}	---	---	---	---	---	---	---	---
G <sub>1(h8)</sub>	60	70	80	70	80	95	110	80	95	110	130	130
H	50	60	72	60	72	86	103	72	86	103	127,5	127,5
H <sub>1</sub>	71,5	84	102	84	102	119	135	102	119	135	167,5	167,5
H <sub>2</sub>	15	20	22	20	22	26	33	22	26	33	42,5	42,5
I	40	50	60	50	60	70	85	60	70	85	110	110
I <sub>1</sub>	32	32	32	40	40	40	40	50	50	50	50	50
K	153,5	171	177	173-178*	183 188*	209-214*	224 229*	207	232,5	250,5	264,5	328
L	23	23	23	30	30	30	30	40	40	40	40	50
M <sub>1</sub>	21,8	27,3	28,3	27,3	28,3	31,3	35,3	28,3	31,3	35,3	45,3	45,3
M <sub>2</sub>	12,5	12,5	12,5	16	16	16	16	22,5	22,5	22,5	22,5	27
N <sub>1</sub>	6	8	8	8	8	8	10	8	8	10	12	12
N <sub>2</sub>	4	4	4	5	5	5	5	6	6	6	6	8
P	69 {99}	93 [90,5]	86 {116}	93 [90,5]	86 {116}	111	111	86 {116}	111	111	131	131
	---	{123}	---	{123}	---	---	---	---	---	---	---	---
P <sub>1</sub>	86	100	110	100	110	130	160	110	130	160	200	200
P <sub>2</sub>	28 {58}	44 [41,5]	25 {56}	44 [41,5]	25 {56}	51	50	25 {56}	51	50	53,5	53,5
	---	{74}	---	{74}	---	---	---	{56}	---	---	---	---
R	87 {87}	90 [130]	150,5	90 [130]	150,5	165	175	150,5	165	175	230	230
		{90}	{150,5}	{90}	{150,5}			{150,5}				
R <sub>1</sub>	75	85	95	85	95	115	130	95	115	130	165	165
S	38,5	46,5	57	46,5	57	57	67	57	57	67	74	74
S <sub>1</sub>	7	8	10	8	10	11	14	10	11	14	13	13
S <sub>2</sub>	2,5	3	3	3	3	3	3	3	3	3	3,5	3,5
U	4 {4}	5 [11] {5}	6,5 {6,5}	5 [11] {5}	6,5 {6,5}	12	6	6,5 {6,5}	12	6	5	5
V	9 {9}	11 [9] {9}	11 {11}	11 [9] {9}	11 {11}	13	13	11 {11}	13	13	14	14
V <sub>1</sub>	M6x8 (4)	M8x10 (4)	M8x16 (8)	M8x10 (4)	M8x16 (8)	M8x16 (8)	M10x18 (8)	M8x16 (8)	M8x16 (8)	M10x18 (8)	M10x21 (8)	M10x21 (8)
V <sub>3</sub>	M4 x 10	M4 x 10	M4 x 10	M6 x 15	M6 x 15	M6 x 15	M6 x 15	M8 x 20	M8 x 20	M8 x 20	M8 x 20	M8 x 20
Y <sub>1</sub>	105	105	105	120	120	120	120	140	140	140	140	140
Z	6 {8}	10 [13] {10}	10 {10}	10 [13] {10}	10 {10}	14	16	10 {10}	14	16	18	18
Z <sub>2</sub>	13	13	13	13 - 18,5	13 - 18,5	13 - 18,5	13 - 18,5	14 - 15	14 - 15	14 - 15	14 - 15	14 - 15

\* - IEC71-B14 (FTA 71/50, FTA71/60, FTA71/70, FTA71/85)

\*\* - 90° per RS28 / 45° per altri tipi

Dimensioni motore: vedi pag. 33

Dimensioni non impegnative

\*\* - 90° for RS28 / 45° for other sizes

Motor dimensions: see page 33

Not binding dimensions

\*\* - 90° für RS28 / 45° für die andere Type

Abmessungen Motor: siehe Seite 33

unverbindliche Abmessungen

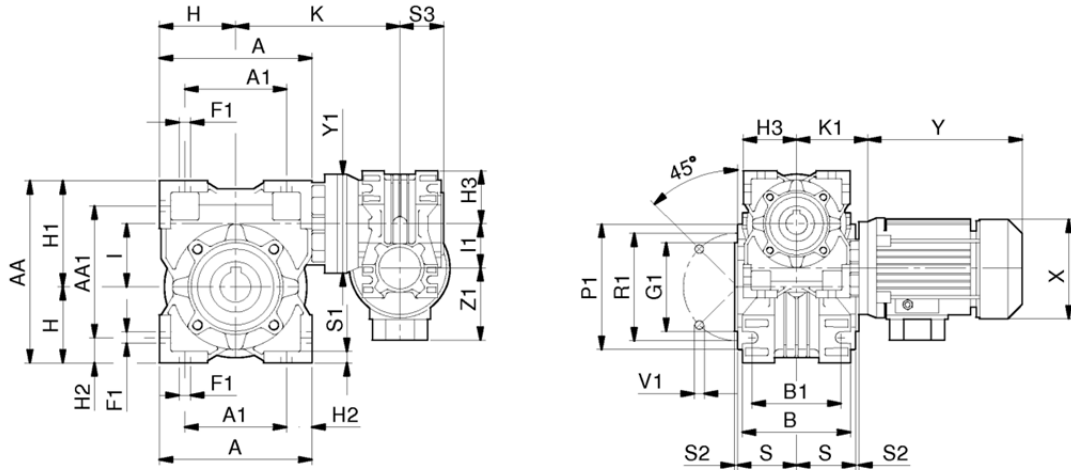

**B3**

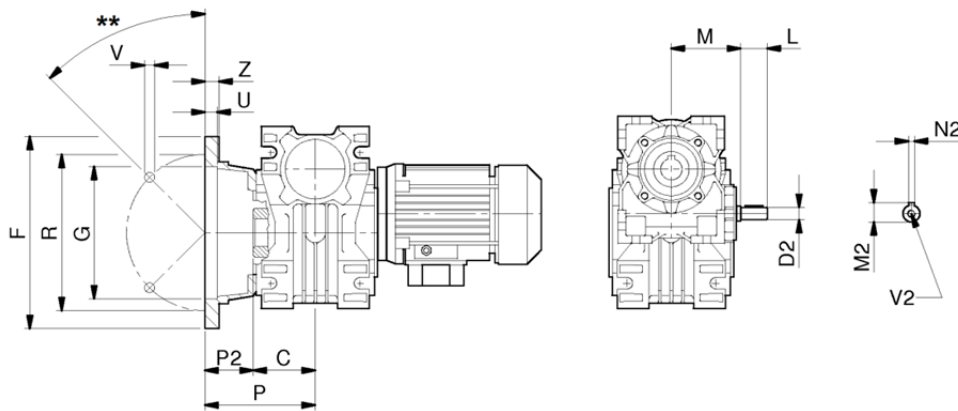
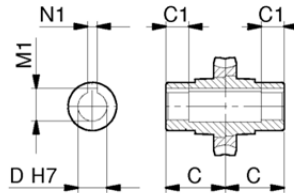

**F, [FV], {FL}**

**RT/RT**

# RT/RT

# Getriebe - Gearboxes - Riduttori RS-RT

Abmessungen - Overall dimensions - Dimensioni di ingombro

RT/RT	28/28	28/40	28/50	28/60	40/70	40/85	50/110
A	80	100	120	144	172	206	255
A <sub>1</sub>	54	70	80	100	120	140	170
AA	97	121,5	144	174	205	238	295
AA <sub>1</sub>	71	91,5	104	130	153	172	210
B	53	71	85	100	112	130	144
B <sub>1</sub>	44	60	70	85	90	100	115
C	30	41	49	60	60	61	77,5
C <sub>1</sub>	26,5	26	30,5	39	37,5	38,5	52,5
D (H7)	14	18-19-20	24-25	25	25-28-30	32-35	42
D <sub>2</sub> (h6)	9	9	9	9	11	11	14
F	80	110 {110}	125 [160] {125}	180 {180}	200	210	270
F <sub>1</sub>	7	7	9	9	11	13	15
G (H8)	50	60 {60}	70 [110] {70}	115 {115}	130	152	170
G <sub>1</sub> (h8)	55	60	70	80	95	110	130
H	40	50	60	72	86	103	127,5
H <sub>1</sub>	57	71,5	84	102	119	135	167,5
H <sub>2</sub>	13	15	20	22	26	33	42,5
H <sub>3</sub>	40	40	40	40	50	50	60
I	28	40	50	60	70	85	110
I <sub>1</sub>	28	28	28	28	40	40	50
K	79,5	115,5	134	145,5	182	199	203
K <sub>1</sub>	57,5	57,5	57,5	57,5	70,5	70,5	83 - 88*
L	20	20	20	20	23	23	30
M	50	50	50	50	65	65	75
M <sub>1</sub>	16,3	21,8	27,3	28,3	31,3	35,3	45,3
M <sub>2</sub>	10,2	10,2	10,2	10,2	12,5	12,5	16
N <sub>1</sub>	5	6	8	8	8	10	12
N <sub>2</sub>	3	3	3	3	4	4	5
P	53	69 {99}	93 [90,5] {123}	86 {116}	111	111	131
P <sub>1</sub>	75	86	100	110	130	160	200
P <sub>2</sub>	23	28 {58}	44 [41,5] {74}	25 {56}	51	50	53,5
R	68	87 {87}	90 [130] {90}	150,5 {150,5}	165	175	230
R <sub>1</sub>	65	75	85	95	115	130	165
S	27,5	38,5	46,5	57	57	67	74
S <sub>1</sub>	6	7	8	10	11	14	13
S <sub>2</sub>	2,5	2,5	3	3	3	3	3,5
S <sub>3</sub>	30	30	30	30	41	41	49
U	10	4 {4}	5 [11] {5}	6,5 {6,5}	12	6	5
V	7	9 {9}	11 [9] {9}	11 {11}	13	13	14
V <sub>1</sub>	M6x10 (4)	M6x8,5 (4)	M8x10 (4)	M8x16 (8)	M8x16 (8)	M10x18 (8)	M10x21 (8)
V <sub>2</sub>	M4x10	M4x10	M4x10	M4x10	M4x10	M4x10	M6x15
Y <sub>1</sub>	80	90	90	90	120	120	120
Z	7	6 {8}	10 [13] {10}	10 {10}	14	16	18

\* - IEC71-B14 (FRT50)

\*\* - 90° per RS28 / 45° per altri tipi

Dimensioni motore: vedi pag, 33

Dimensioni non impegnative

\*\* - 90° for RS28 / 45° for other sizes

- Motor dimensions: see page 33

- Not binding dimensions

\*\* - 90° für RS28 / 45° für die andere Type

- Abmessungen Motor: siehe Seite 33

- unverbindliche Abmessungen

# RS-RT Riduttori - Gearboxes - Getriebe

# RT

Accessori - Accessories - Zubehöre

**AS**

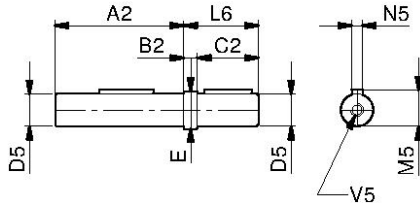

**AD**

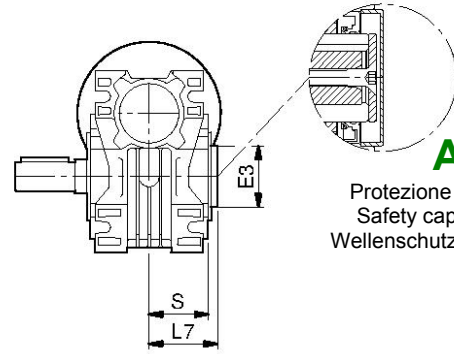
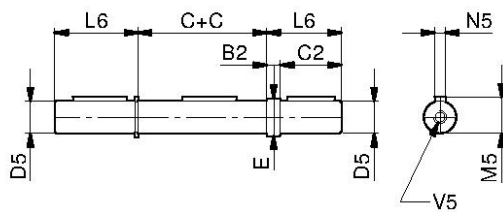

**ASC**

Protezione per AS  
Safety cap for AS  
Wellenschutz für AS

**BT**

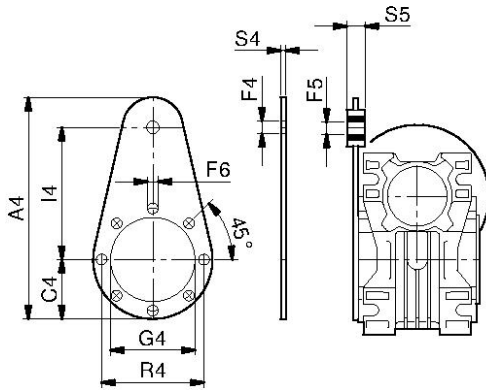

**BTV**

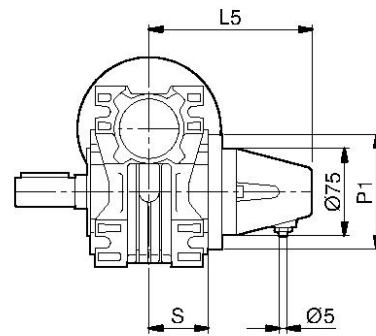

**SL**

**TLE**

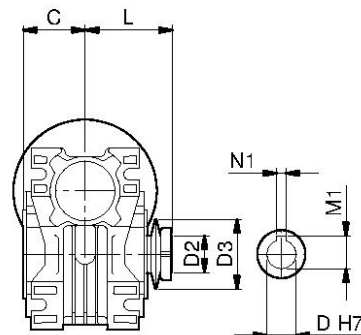
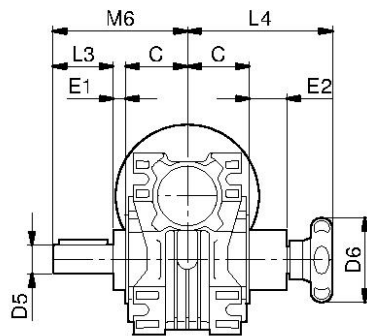

**TLI**

**VB**

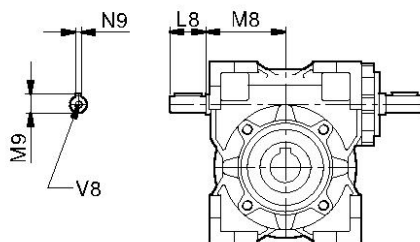

**TLI**

**Olio - Oil - Öl**

Litri / Litres / Liter

RT 28 0.04

RT 40 0.10

RT 50 0.13

RT 60 0.30

RT 70 0.45

RT 85 0.75

RT 110 2.25

# RT

# Getriebe - Gearboxes - Riduttori RS-RT

Abmessungen - Overall dimensions - Dimensioni di ingombro

RT	28	40	50	60	70	85	110
<b>AS &amp; AD</b> A <sub>2</sub>	58	80	95	117	117	119	153
B <sub>2</sub>	1	10	10	10	10	10	10
C	30	41	49	60	60	61	77,5
C <sub>2</sub>	30	40	45	50	60	70	110
D <sub>5</sub> (g6)	14	19 (18)	24 (25)	25	28	32 (35)	42
E	14	22	28	30	34	38	50
L <sub>6</sub>	31	50	55	60	70	80	110
M <sub>5</sub>	16	21,5	27	28	31	35	45
N <sub>5</sub> (h9)	5	6	8	8	8	10	12
V <sub>5</sub>	M5x10	M8x20	M8x20	M8x20	M8x20	M10x25	M10x25
<b>ASC</b> E <sub>3</sub>	50	52	62	75	90	100	120
L <sub>7</sub>	36	48,5	55,5	68,5	67	77	85
S	27,5	38,5	46,5	57	57	67	74
<b>BT &amp; BTV</b> A <sub>4</sub>	138	168	185	235	295	313	388
C <sub>4</sub>	38	43	60	55	65	75	100
F <sub>4</sub>	10,5	10,5	10,5	10,5	10,5	20,5	20,5
F <sub>5</sub> (0/+0.4)	10	10	10	10	10	20	20
F <sub>6</sub>	7	7	9	9	9	12	13
G <sub>4</sub>	55	60	70	80	95	110	130
I <sub>4</sub>	80	100	100	150	200	200	250
R <sub>4</sub>	65	75	85	95	115	130	165
S <sub>4</sub>	4	4	4	6	6	6	6
S <sub>5</sub>	15	15	15	20	20	25	25
<b>SL</b> L <sub>5</sub>	96	113	123	133	133	139	150
P <sub>1</sub>	78	90	100	110	130	160	200
S	27,5	38,5	46,5	57	57	67	74
<b>TLE</b> D <sub>6</sub>	52	70	70	70	80	100	100
E <sub>1</sub>	10	12	12	15	14	19	24
E <sub>2</sub>	28	37	31	40	46	57	71
L <sub>3</sub>	30	40	50	50	60	70	80
L <sub>4</sub>	94	116	118	128	146	168	201
M <sub>6</sub>	70	93	111	125	134	150	181
<b>TLI</b> D <sub>(H7)</sub>	14	18/19	24/25	25	28	32/35	42
D <sub>2</sub>	14,2 x 20	19,5 x 20,5	24,5 x 28	25,5 x 26	28,5 x 22	32,5 x 27	42,5 x 38,5
D <sub>3</sub>	40	56	71	71	80	90	125
L	45	61,5	77	86,5	89	94	112,5
M <sub>1</sub>	15,4*	21,8	27,3	27,3*	31,3	35,3	45,3
N <sub>1</sub> (h9)	5	6	8	8	8	10	12
<b>VB</b> D <sub>9</sub>	9	11	14	19	19	24	28
L <sub>8</sub>	20	23	30	40	40	50	60
M <sub>8</sub>	43	55	65	77	89	106,5	145
M <sub>9</sub>	10,2	12,5	16	22,5	22,5	27	31
N <sub>9</sub> (h9)	3	4	5	6	6	8	8
V <sub>8</sub>	M4x10	M4x10	M6x15	M8x20	M8x20	M8x20	M8x20

D<sub>5</sub> (,,) = Diametro a richiesta  
Dimensioni non impegnative

D<sub>5</sub> (,,) = Diameter on demand  
Not binding dimensions

D<sub>5</sub> (,,) = Durchmesser auf Anfrage  
unverbindliche Abmessungen

# RS-RT Riduttori - Gearboxes - Getriebe

**XA**

Dimensioni di ingombro e Pesì - Overall dimensions and Weights - Abmessungen u. Gewichte

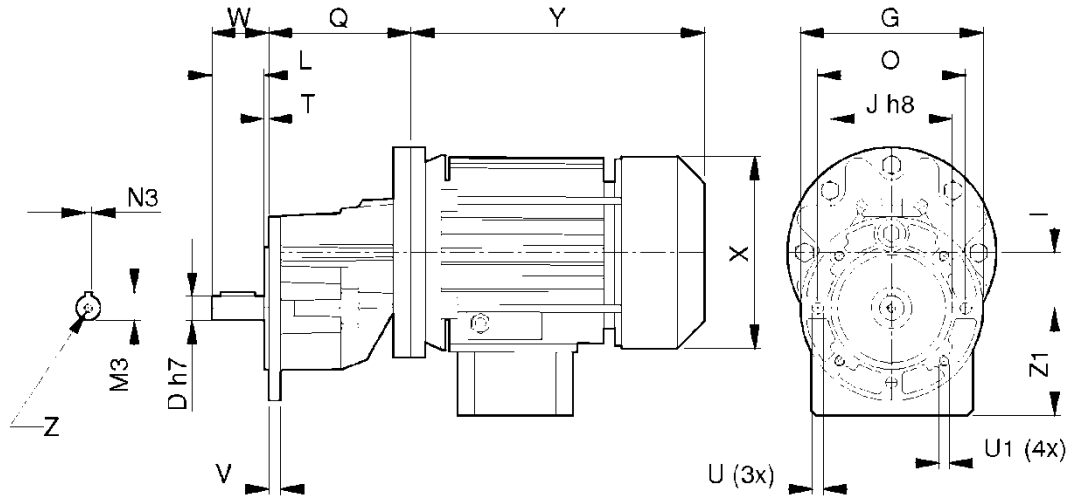

XA	D <sub>H7</sub>	G	I	J <sub>h8</sub>	L	M <sub>3</sub>	N <sub>3 h9</sub>	O	Q	U	U1	T	V	W	Z
63	14	105	32	70	30	16	5	85	83	6,5	M6	2,5	7	32,5	M5x10
71	19	120	40	80	40	22.5	6	100	90	5,5	M6	2,5	7,5	42,5	M8x20
80	24	140	50	95	49,5	27	8	115	114	9	M8	2,5	10,5	52	M8x20
100	28	200	63	130	57,5	31	8	165	177	10,5	10,5	2,5	12	60	M10 x 22

IEC B5	56	63	71	80	S <sup>90</sup>	L	100	112
X	110	123	137	156	176	176	194	218
Y	168	190.5	218	242	255	280	312	330
Z <sub>1</sub> + I	95	100	109	123	128	128	140	148

XA	Peso - Weight - Gewicht kg	Olio - Oil - Öl litri/litres/liter
63	1.5	0.04
71	2.2	0.06
80	3.0	0.10
100	7.0	0.20

- Dimensioni e pesi non impegnativi  
 - Not binding dimensions and weights  
 - unverbindliche Abmessungen und Gewichte

## Getriebe - Gearboxes - Riduttori RS-RT

### Umkehrbarkeit u. Selbsthemmung - Back-Driving and Self-Locking - Reversibilità e Irreversibilità

Azionando al contrario un riduttore a vite senza fine con la ruota come organo motore, il rendimento è inferiore a quello di un azionamento con vite motrice e, agendo sui dati di progetto, il rendimento può essere ridotto a zero, ottenendo l'irreversibilità dell'ingranamento.

In quest'azionamento al contrario, l'attrito interno tende a bloccare l'ingranamento e, quanto maggior coppia è applicata alla ruota motrice, tanto più l'attrito d'ingranamento aumenta proporzionalmente ostacolando la rotazione.

L'esempio più ovvio è dato dalla frenatura o dall'abbassamento del carico per inerzia, dove la coppia esterna azionerà al contrario la vite.

Un riduttore a vite senza fine è considerato irreversibile quando l'angolo d'elica è inferiore all'angolo d'attrito (arcotangente del coefficiente d'attrito).

Il contatto sulla dentatura è dinamico anche quando la velocità d'ingranamento è zero, in quanto le vibrazioni su un ingranaggio non rotante possono originare il moto nella zona di contatto.

Si consiglia come fattore di sicurezza la scelta di un angolo d'elica di 3° quale condizione di massima irreversibilità e di 10° quale condizione di minima irreversibilità, secondo la tabella delle relazioni fra angolo d'elica ed irreversibilità.

When back-driving a worm gear set using the worm wheel as input, the efficiency is lower than forward-driving and, by varying the design data, back-drive efficiency can be reduced to zero obtaining a self-locking, or irreversible, gear set.

When back-driving the worm gear, internal friction tends to lock the mesh, and the bigger the applied torque is, the more mesh friction increases proportionally augmenting the lockage at the same time.

The most obvious example is during braking or slowing-down where the inertial load will try to back-drive the worm shaft.

A worm gear is intended as a self-locking unit when the lead angle is less than the friction angle (arc tangent of friction coefficient).

Tooth contact is dynamic even when the mesh velocity is zero, as vibrations in a non-rotating gear set can induce motion in the tooth contact.

To provide a safety factor, a 3° lead angle is recommended for full self-locking condition, and 10° lead angle for poor self-locking condition, according to the table of relations between lead angles and self-locking.

Wird das Schneckengetriebe über die Abtriebswelle angetrieben, ist der Wirkungsgrad des Getriebes schlechter als bei Antrieb über die Eingangswelle. Dabei kann in Abhängigkeit von der Verzahnung der Wirkungsgrad bis Null reduziert sein, was eine auftretende Selbsthemmung bis hin zur vollständigen Blockierung zur Folge hat.

Dieser Fall kann beispielsweise bei Abbremsung oder Senkung einer Last auftreten, wenn die Abtriebswelle durch die Last angetrieben wird.

Ein Schneckengetriebe wird als selbsthemmend bezeichnet, wenn der Spiralwinkel kleiner ist als der Reibungswinkel (Arkustangens vom Reibungskoeffizient).

Der Verzahnungseingriff ist dynamisch, auch wenn die Eingriffsgeschwindigkeit Null ist, da Vibrationen auf ein nicht drehendes Rad eine Bewegung hervorrufen können.

Empfohlen wird, als Sicherheitsfaktor, die Wahl eines Spiralwinkels von 3° als Bedingung einer maximalen Selbsthemmung und von 10° als Bedingung einer geringen Selbsthemmung, wie aus der folgenden Tabelle ersichtlich wird.

Elica Lead angle Spiralwinkel	Irreversibilità statica	Static self-locking	Statische Selbsthemmung
$\beta > 20^\circ$	Reversibilità piena	Full back-driving	Volle Umkehrbarkeit
$10^\circ < \beta < 20^\circ$	Reversibilità elevata	High back-driving	Hohe Umkehrbarkeit
$5^\circ < \beta < 10^\circ$	Reversibilità buona Irreversibilità scarsa	Good back-driving Poor self-locking	Gute Umkehrbarkeit Schwache Selbsthemmung
$3^\circ < \beta < 5^\circ$	Reversibilità scarsa Irreversibilità buona	Poor back-driving Good self-locking	Schwache Umkehrbarkeit Gute Selbsthemmung
$1^\circ < \beta < 3^\circ$	Irreversibilità piena	Full self-locking	Volle Selbsthemmung

## RS-RT Riduttori - Gearboxes - Getriebe

### Dati di dentatura - Gearing data - Verzahnungsdaten

	i =	5	7	10	15	20	28	40	49	56	70	80	100
<b>RS/RT 28</b>	$m_x$ $\beta$ $z_1$	---	1,50 23°11'	1,40 16°41'	1,40 11°18'	1,10 10°23'	1,50 6°06'	1,10 5°14'	0,90 4°19'	0,75 3°03'	0,60 2°27'	0,55 2°37'	0,45 2°20'
			4	3	2	2	1	1	1	1	1	1	1
<b>RS/RT 40</b>	$m_x$ $\beta$ $z_1$	2,00 30°57'	2,10 21°36'	2,00 16°41'	2,00 11°18'	1,50 8°31'	2,10 5°39'	1,50 4°17'	1,25 3°48'	1,10 3°25'	0,90 3°01'	0,80 2°51'	0,65 2°38'
		6	4	3	2	2	1	1	1	1	1	1	1
<b>RS/RT 50</b>	$m_x$ $\beta$ $z_1$	2,50 30°57'	2,70 23°52'	2,50 16°41'	2,50 11°18'	1,90 8°59'	2,70 6°19'	1,90 4°31'	1,60 4°14'	1,40 3°42'	1,10 2°44'	1,00 2°51'	0,80 2°17'
		6	4	3	2	2	1	1	1	1	1	1	1
<b>RS/RT 60</b>	$m_x$ $\beta$ $z_1$	3,15 36°32'	3,30 25°33'	3,10 19°0'	3,10 12°55'	2,40 11°18'	3,30 6°49'	2,40 5°42'	2,00 5°11'	1,70 3°55'	1,40 3°38'	1,20 2°51'	1,00 2°51'
		6	4	3	2	2	1	1	1	1	1	1	1
<b>RS/RT 70</b>	$m_x$ $\beta$ $z_1$	3,60 34°01'	3,90 26°51'	3,60 18°38'	3,60 12°40'	2,80 11°18'	3,90 7°12'	2,80 5°42'	2,30 4°48'	2,00 4°05'	1,60 3°16'	1,40 2°51'	1,15 2°38'
		6	4	3	2	2	1	1	1	1	1	1	1
<b>RS/RT 85</b>	$m_x$ $\beta$ $z_1$	4,40 34°47'	4,70 26°05'	4,40 19°09'	4,40 13°02'	3,40 11°18'	4,70 6°58'	3,40 5°52'	2,80 4°52'	2,50 4°45'	2,00 3°48'	1,74 3°14'	1,40 2°40'
		6	4	3	2	2	1	1	1	1	1	1	1
<b>RS/RT 110</b>	$m_x$ $\beta$ $z_1$	---	6,10 26°22'	5,80 20°43'	5,80 14°09'	4,40 11°18'	6,10 7°04'	4,40 5°42'	3,60 4°43'	3,20 4°29'	2,60 3°54'	2,30 3°39'	1,80 2°34'
			4	3	2	2	1	1	1	1	1	1	1
<b>RS 130</b>	$m_x$ $\beta$ $z_1$	---	7,25 26°57'	6,90 21°20'	6,85 14°06'	5,35 13°05'	7,25 7°14'	5,30 6°18'	4,35 5°18'	4,00 6°20'	3,15 4°33'	2,70 3°30'	2,25 3°40'
			4	3	2	2	1	1	1	1	1	1	1
<b>RS 150</b>	$m_x$ $\beta$ $z_1$	---	8,25 25°33'	8,00 21°48'	8,15 16°22'	6,20 13°24'	8,45 7°35'	6,25 7°07'	5,10 5°48'	4,60 6°11'	3,60 4°17'	3,15 3°45'	2,60 3°43'
			4	3	2	2	1	1	1	1	1	1	1

$m_x$  = Modulo assiale  
 $z_1$  = N, principi  
 $\beta$  = Angolo d'elica (dx)  
 $20^\circ$  = Angolo di pressione

$m_x$  = Axial module  
 $z_1$  = Number of starts  
 $\beta$  = Lead angle (r.h.)  
 $20^\circ$  = Pressure angle

$m_x$  = Axialmodul  
 $z_1$  = Steigungen  
 $\beta$  = Spiralwinkel (rechts)  
 $20^\circ$  = Eingriffswinkel



# Getriebe - Gearboxes - Riduttori RS-RT

Drehrichtungen - Direction of rotation - Senso di rotazione

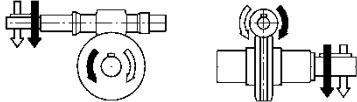
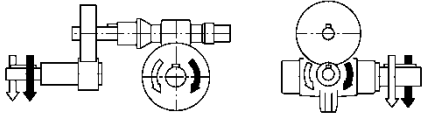
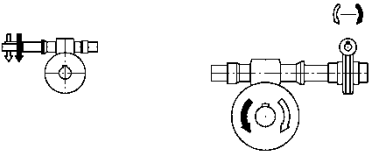
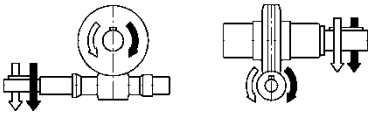
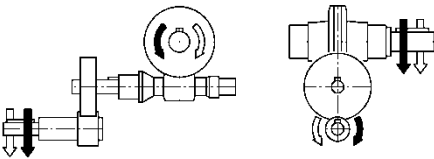
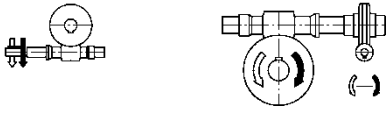
<p>- VITE in alto WORMSHAFT upwards oben SCHNECKE</p>	<p><b>RS-RT</b></p>  <p><b>RA-TA</b></p>  <p><b>RS-RS RT/RT</b></p> 
<p>- VITE in basso WORMSHAFT downwards unten SCHNECKE</p>	<p><b>RS-RT</b></p>  <p><b>RA-TA</b></p>  <p><b>RS-RS RT/RT</b></p> 

# RS-RT Riduttori - Gearboxes - Getriebe

## Estratto delle ISTRUZIONI D'USO E MANUTENZIONE

(manuale completo su [www.varvel.com](http://www.varvel.com))

I riduttori e i variatori di velocità non ricadono nel campo d'applicazione della Direttiva Macchine, art.1(2) e non possono essere messi in servizio finché la macchina nella quale devono essere incorporati, sia stata dichiarata conforme all'art. 4(2), all. II(B) delle Direttive Macchine 98/37/CEE/22,6,98 e, solo per l'Italia, al DL 459/24,7,96.

### Installazione

Accertarsi che il gruppo da installare abbia le caratteristiche atte a svolgere la funzione richiesta e che la posizione di montaggio sia coerente con quanto ordinato. Tali caratteristiche sono deducibili dalla targhetta d'identificazione apposta sul riduttore. Effettuare la verifica della stabilità del montaggio affinché non si verifichino vibrazioni o sovraccarichi durante il funzionamento.

### Funzionamento

Il riduttore può essere collegato per rotazione oraria o antioraria. Arrestare immediatamente il riduttore in caso di funzionamento difettoso o di rumorosità anomala, rimuovere il difetto o ritornare l'apparecchio alla fabbrica per un'adeguata revisione. Se la parte difettosa non è sostituita, anche altri componenti possono essere danneggiati con conseguenti ulteriori danneggiamenti e più scarsa possibilità di risalire alle cause.

### Manutenzione

Sebbene i gruppi siano provati con funzionamento senza carico prima della spedizione, è consigliabile non usarli a carico massimo durante le prime 20-30 ore di funzionamento affinché le parti interne possano adattarsi reciprocamente. I riduttori sono spediti già riempiti con olio sintetico a lunga durata e, se occorre sostituire o rabboccare il lubrificante, non mescolare oli a base sintetica con oli a base minerale.

### Movimentazione

In caso di sollevamenti con paranco, utilizzare posizioni di aggancio sulla struttura della carcassa, golfari ove esistenti, fori dei piedi o sulle flange, evitando tutte le parti mobili.

### Verniciatura

Qualora il gruppo subisca una verniciatura successiva, è necessario proteggere accuratamente gli anelli di tenuta, i piani di accoppiamento e gli alberi sporgenti.

### Conservazione prolungata a magazzino

Per permanenze maggiori di tre mesi, è consigliata l'applicazione di antiossidanti su alberi esterni e piani lavorati, e di grasso protettivo sui labbri dei paraolio.

### Gestione Ambientale del prodotto

In conformità alla Certificazione Ambientale ISO 14001, sono suggerite le seguenti indicazioni per lo smaltimento del nostro prodotto:

- i componenti del gruppo che vengono rottamati debbono essere consegnati a centri di raccolta autorizzati per i materiali metallici;
- gli oli ed i lubrificanti raccolti dal gruppo devono essere smaltiti consegnandoli ai Consorzi Oli esausti;
- gli imballi a corredo dei gruppi (pallet, cartone, carta, plastica, ecc.) vanno avviati per quanto più possibile al recupero/riciclo, consegnandoli a ditte autorizzate per le singole classi di rifiuto.

## Abstract of OPERATION AND MAINTENANCE INSTRUCTIONS

(complete manual on [www.varvel.com](http://www.varvel.com))

Variable speed and reduction gearboxes are not part of the field of application of the Machinery Directive, art.1(2), and they must not be put into service until the machinery into which they are to be incorporated, has been declared in conformity with the provision of art.4(2), annex II(B) of Machinery Directives 98/37/CEE/22,6,98 and for Italy only, of DL 459/24,7,96.

### Installation

Check if the unit to be installed is properly selected to perform the required function and that its mounting position complies with the order. The nameplate reports such information. Check mounting stability to ensure the unit runs without vibrations or overloads.

### Running

The unit may be connected for clockwise or counter-clockwise rotation.

Immediately stop the unit, as soon as defective running or unexpected noise occur, remove the faulty part or return the unit to the factory for checking.

If the faulty part is not replaced, other parts can also be affected, causing more severe damage and making the identification of initial cause more difficult.

### Maintenance

Although the units are tested with no load in the factory before despatch, it is recommended not to run them at maximum load for the first 20-30 working hours to allow the proper running in.

The gearboxes are delivered already filled with long-life synthetic oil and, in case of replacement or top up, this type of oil cannot be mixed with mineral lubricants.

### Handling

When hoisting, use relevant housing locations or eyebolts if provided, or foot or flange holes. Never hoist on any moving part.

### Painting

Carefully protect oil seals, coupling surfaces and shafts when units are repainted.

### Long-term storage

For storage longer than three months, apply antioxidants onto shafts and machined surfaces, and protective grease on oil seal lips.

### Product's Environmental Management

In conformity with Environmental Certification ISO 14001, we recommend the following to dispose of our products:

- scraped components of the units to be delivered to authorized centres for metal object collection;
- oils and lubricants drained from the units to be delivered to Exhausted Oil Unions;
- packages (pallets, carton boxes, paper, plastic, etc.) to be placed in the appropriate bins, in order for authorized companies to pick them up according to the waste types.

## Zusammenfassung der BETRIEBS- u. WARTUNGSANWEISUNGEN

(vollständiges Handbuch auf [www.varvel.com](http://www.varvel.com))

Varvel-Getriebe und Variatoren fallen nicht unter den Geltungsbereich der Maschinenrichtlinien, Artikel 1 (2): Sie dürfen jedoch nicht in Betrieb gesetzt werden, bevor sich nicht Maschinen, in die sie eingebaut werden, mit Artikel 4 (2), Anhang II (B) der Maschinenrichtlinien 98/37/ CEE/22,6,98, und (nur für Italien) DL 459/ 24,07,96, in Übereinstimmung befinden.

### Aufstellung

Vor der Aufstellung ist zu prüfen, dass die Antriebseinheit in bezug auf die Betriebsbedingungen richtig ausgewählt wurde und die Einbaulage mit der Bestellung übereinstimmt. Angaben hierüber sind auf dem Typenschild zu finden. Die Stützkonstruktion für die Getriebe ist so stabil auszuführen, dass keine Schwingungen oder Überlastungen auftreten, eventuell sind elastische Kupplungen oder Drehmomentbegrenzer zu verwenden.

### Inbetriebnahme

Die Antriebseinheit kann in beiden Drehrichtungen eingesetzt werden. Die Einheit müsst sofort angehalten werden, wenn ein unzulässiger Lauf oder unerwartete Geräusche auftreten.

Das fehlerhafte Teil ist zu ersetzen oder die Einheit ist zur Überprüfung einzuschicken, Falls das fehlerhafte Teil nicht ersetzt wird, kann dies zu weiteren Schäden an anderen Bauteilen führen, was eine Feststellung der Ursachen sehr schwierig machen kann.

### Wartung

Obwohl die Einheiten vor der Auslieferung im Leerlauf getestet wurden, ist es ratsam sie in den ersten 20-30 Stunden nicht mit Vollast zu betreiben, um ein einwandfreies Einlaufen zu gewährleisten. Die Einheiten werden entsprechend den Angaben auf dem Typenschild mit synthetischem Schmierstoff Lebensdauer geschmiert ausgeliefert. Bei einem eventuellen Ölwechsel oder Nachfüllen darf der Schmierstoff nicht mit Mineralöl vermischt werden.

### Handhabung und Transport

Beim Heben und Transport ist auf standsichere Lage und sorgfältige Befestigung geeigneter Hebevorrichtungen zu achten, Bewegliche Teile dürfen nicht zum Anheben benutzt werden.

### Anstrich

Beim Erneuern oder dem zusätzlichen Aufbringen eines Anstriches sind die Dichtungen, Kupplungssitze und Wellen sorgfältig zu schützen.

### Langzeitlagerung

Die Einlagerung der Einheiten muss trocken und staubfrei erfolgen. Bei einer Einlagerungszeit über 3 Monate sind bearbeitete Flächen und Wellen mit Rostschutzmitteln zu besprühen, Dichtlippen sind mit Fett zu schützen.

### Entsorgung

In Übereinstimmung mit ISO 14001 weisen wir darauf hin, im Falle des Verschrottens die einzelnen Metallteile getrennt zu behandeln und Schmiermittel bei den befügten Stellen zu entsorgen. Verpackungen sollten soweit wie möglich wieder verwendet werden.

ARGENTINA  
AUSTRALIA  
AUSTRIA  
BELARUS  
BELGIUM  
BRAZIL  
BULGARIA  
CANADA  
CHILE  
CHINA  
COLOMBIA  
COSTA RICA  
CROATIA  
CYPRUS  
CZECH REPUBLIC  
DENMARK  
ECUADOR  
EGYPT  
ESTONIA  
FINLAND  
FRANCE  
GERMANY  
GREECE  
HOLLAND  
HONG KONG  
HUNGARY  
ICELAND  
**INDIA - Branch**  
INDONESIA  
IRAN  
IRELAND  
ISRAEL  
**ITALY - Headquarters**  
KENYA  
KOREA (SOUTH)  
LEBANON  
LIBYA  
LITHUANIA  
MALAYSIA  
MAURITIUS  
MEXICO  
MOROCCO  
NEW ZEALAND  
NORWAY  
PAKISTAN  
PARAGUAY  
PERU  
POLAND  
PORTUGAL  
ROMANIA  
RUSSIA  
SAUDI ARABIA  
SERBIA  
SINGAPORE  
SLOVAKIA  
SLOVENIA  
SOUTH AFRICA  
SPAIN  
SWEDEN  
SWITZERLAND  
TAIWAN  
THAILAND  
TUNISIA  
TURKEY  
UKRAINE  
UNITED ARAB EMIRATES  
UNITED KINGDOM  
URUGUAY  
USA  
VIETNAM



Branch:

**MGM-VARVEL** Power Transmission Pvt Ltd  
Warehouse N. G3 and G4 ▪ Ground Floor  
Indus Valley's Logistic Park ▪ Unit 3  
Mel Ayanambakkam ▪ Vellala Street  
Chennai - 600 095 ▪ Tamil Nadu, INDIA  
info@mgmvarvelindia.com  
www.mgmvarvelindia.com



# VARVEL®

MOTION CONTROL SINCE 1955

technology made in Italy



**VARVEL** SpA

Via 2 Agosto 1980, 9 ▪ Loc. Crespellano  
40053 Valsamoggia (BO) ▪ Italy

☎ +39 051 6721811

☎ +39 051 6721825

varvel@varvel.com

www.varvel.com