



Main catalog

Motor protection and control

Manual motor starters, contactors and overload relays

Power and productivity
for a better world™



Motor rated operational powers and currents

The currents given below concern standard three-phase four-pole cage motors (1500 r.p.m. at 50 Hz 1800 r.p.m. at 60 Hz). These values are given for guidance and may vary according to the motor manufacturer and depending on the number of poles.

IEC Motor power kW	Motor nominal current: standardized values in blue colour (according to IEC 60947-4-1 Annex G)									
	220 V	230 V	240 V	380 V	400 V	415 V	440 V	500 V	660 V	690 V
0.06	0.37	0.35	0.34	0.21	0.2	0.19	0.18	0.16	0.13	0.12
0.09	0.54	0.52	0.50	0.32	0.3	0.29	0.26	0.24	0.18	0.17
0.12	0.73	0.7	0.67	0.46	0.44	0.42	0.39	0.32	0.24	0.23
0.18	1	1	1	0.63	0.6	0.58	0.53	0.48	0.37	0.35
0.25	1.6	1.5	1.4	0.9	0.85	0.82	0.74	0.68	0.51	0.49
0.37	2.0	1.9	1.8	1.2	1.1	1.1	1	0.88	0.67	0.64
0.55	2.7	2.6	2.5	1.6	1.5	1.4	1.3	1.2	0.91	0.87
0.75	3.5	3.3	3.2	2.0	1.9	1.8	1.7	1.5	1.15	1.1
1.1	4.9	4.7	4.5	2.8	2.7	2.6	2.4	2.2	1.7	1.6
1.5	6.6	6.3	6	3.8	3.6	3.5	3.2	2.9	2.2	2.1
2.2	8.9	8.5	8.1	5.2	4.9	4.7	4.3	3.9	2.9	2.8
3	11.8	11.3	10.8	6.8	6.5	6.3	5.7	5.2	4	3.8
4	15.7	15	14.4	8.9	8.5	8.2	7.4	6.8	5.1	4.9
5.5	20.9	20	19.2	12.1	11.5	11.1	10.1	9.2	7	6.7
7.5	28.2	27	25.9	16.3	15.5	14.9	13.6	12.4	9.3	8.9
11	39.7	38	36.4	23.2	22	21.2	19.3	17.6	13.4	12.8
15	53.3	51	48.9	30.5	29	28	25.4	23	17.8	17
18.5	63.8	61	58.5	36.8	35	33.7	30.7	28	22	21
22	75.3	72	69	43.2	41	39.5	35.9	33	25.1	24
30	100	96	92	57.9	55	53	48.2	44	33.5	32
37	120	115	110	69	66	64	58	53	40.8	39
45	146	140	134	84	80	77	70	64	49.1	47
55	177	169	162	102	97	93	85	78	59.6	57
75	240	230	220	139	132	127	116	106	81	77
90	291	278	266	168	160	154	140	128	97	93
110	355	340	326	205	195	188	171	156	118	113
132	418	400	383	242	230	222	202	184	140	134
160	509	487	467	295	280	270	245	224	169	162
200	637	609	584	368	350	337	307	280	212	203
250	782	748	717	453	430	414	377	344	261	250
315	983	940	901	568	540	520	473	432	327	313
355	1109	1061	1017	642	610	588	535	488	370	354
400	1255	1200	1150	726	690	665	605	552	418	400
500	1545	1478	1416	895	850	819	745	680	515	493
560	1727	1652	1583	1000	950	916	832	760	576	551
630	1928	1844	1767	1116	1060	1022	929	848	643	615
710	2164	2070	1984	1253	1190	1147	1043	952	721	690
800	2446	2340	2243	1417	1346	1297	1179	1076	815	780
900	2760	2640	2530	1598	1518	1463	1330	1214	920	880
1000	3042	2910	2789	1761	1673	1613	1466	1339	1014	970

UL/CSA Motor power hp	Motor nominal current: single and three phase (according to UL 60947-4-1A)									
	120 V 1-ph	200 V 1-ph	200 V 3-ph	208 V 1-ph	208 V 3-ph	220- 240 V 1-ph	220- 240 V 3-ph	380- 415 V 3-ph	440- 480 V 3-ph	550- 600 V 3-ph
1/10	3	-	-	-	-	1.5	-	-	-	-
1/8	3.8	-	-	-	-	1.9	-	-	-	-
1/6	4.4	2.5	-	2.4	-	2.2	-	-	-	-
1/4	5.8	3.3	-	3.2	-	2.9	-	-	-	-
1/3	7.2	4.1	-	4	-	3.6	-	-	-	-
1/2	9.8	5.6	2.5	5.4	2.4	4.9	2.2	1.3	1.1	0.9
3/4	13.8	7.9	3.7	7.6	3.5	6.9	3.2	1.8	1.6	1.3
1	16	9.2	4.8	8.8	4.6	8	4.2	2.3	2.1	1.7
1-1/2	20	11.5	6.9	11	6.6	10	6	3.3	3	2.4
2	24	13.8	7.8	13.2	7.5	12	6.8	4.3	3.4	2.7
3	34	19.6	11	18.7	10.6	17	9.6	6.1	4.8	3.9
5	56	32.2	17.5	30.8	16.7	28	15.2	9.7	7.6	6.1
7-1/2	80	46	25.3	44	24.2	40	22	14	11	9
10	100	57.5	32.2	55	30.8	50	28	18	14	11
15	135	-	48.3	-	46.2	68	42	27	21	17
20	-	-	62.1	-	59.4	88	54	34	27	22
25	-	-	78.2	-	74.8	110	68	44	34	27
30	-	-	92	-	88	136	80	51	40	32
40	-	-	120	-	114	176	104	66	52	41
50	-	-	150	-	143	216	130	83	65	52
60	-	-	177	-	169	-	154	103	77	62
75	-	-	221	-	211	-	192	128	96	77
100	-	-	285	-	273	-	248	165	124	99
125	-	-	359	-	343	-	312	208	156	125
150	-	-	414	-	396	-	360	240	180	144
200	-	-	552	-	528	-	480	320	240	192
250	-	-	-	-	-	-	604	403	302	242
300	-	-	-	-	-	-	722	482	361	289
350	-	-	-	-	-	-	828	560	414	336
400	-	-	-	-	-	-	954	636	477	382
450	-	-	-	-	-	-	1030	-	515	412
500	-	-	-	-	-	-	1180	786	590	472

Motor protection and control

Manual motor starters, contactors and overload relays

Overview	1
Manual motor starters	2
B mini contactors	3
AS contactors with screw terminals	4
AF and EK contactors with screw terminals	5
AS and AF contactors with spring terminals	6
Overload relays	7
DRAS and DRAF enclosed starters	8
R contactors	9
Motor management system	10
S800 self resetting current limiting module	11
Certifications and approvals - General technical data	12
Index	13
Marketing material	14

ABB sets a new standard in motor control and power switching

1

Featuring AF technology as standard, the latest range of ABB's contactors establishes a new industry benchmark. The electronically controlled coil offers multiple benefits over conventional alternatives, and together with ABB's wide product offering – an optimal configuration, every time.



Access Global Support

The contactor and motor protection range from ABB is compatible with all major national and international standards and is available worldwide via a global distribution network. One contactor coil now handles 100 V – 250 V, AC / DC for use in Europe or Asia as well as North America.



Simplify design

By reducing contactor coil energy consumption by up to 80 %, panels can be built smaller and transformers more compact. All the features of the AF technology, along with access to drawings and coordination tables online, simplifies your design and assembly process.



Optimize logistics

With its contactor and motor protection range, ABB has managed to reduce the number of contactor coils to just four. The total number of product variants has been reduced by up to 90 %. This simplifies the customers' logistics and cuts administration costs.



Secure uptime

Time to prevent stoppages caused by voltage fluctuations. The AF contactor ensures distinct operation in unstable networks and signifies a major advance in motor control and power switching. Voltage sags, dips and surges pose no threat. The AF contactor secures your uptime.

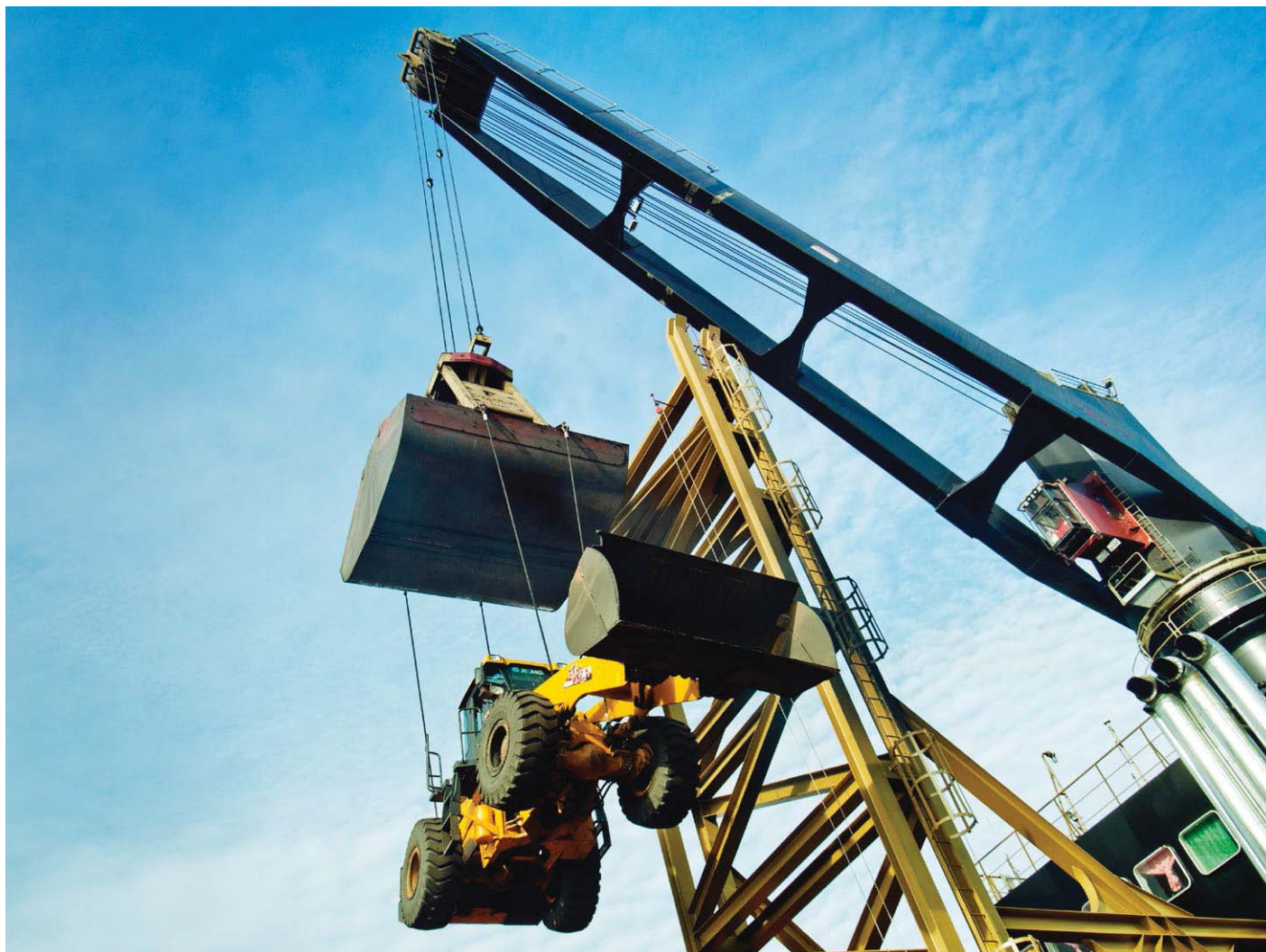

MacGregor. Keeping turnarounds brief.

Until the AF range was installed, voltage sags were affecting MacGregor's deck cranes.

Conventional contactors welded shut, leading to several stoppages a week. No longer. Known for superior quality and an ability to operate in the most hostile environments, MacGregor deck cranes enjoy a global reputation for reliability. A small but vital component, the AF contactor helps maintain this reputation.

To keep things moving, you need Control. Connect to Control.

Explore all our case studies at www.abb.com/connecttocontrol

SSAB
Making certainty
standard

Gamesa
Taming the wind

LKAB
Providing fresh air

Contactors and motor protection

For a wide variety of segments

1

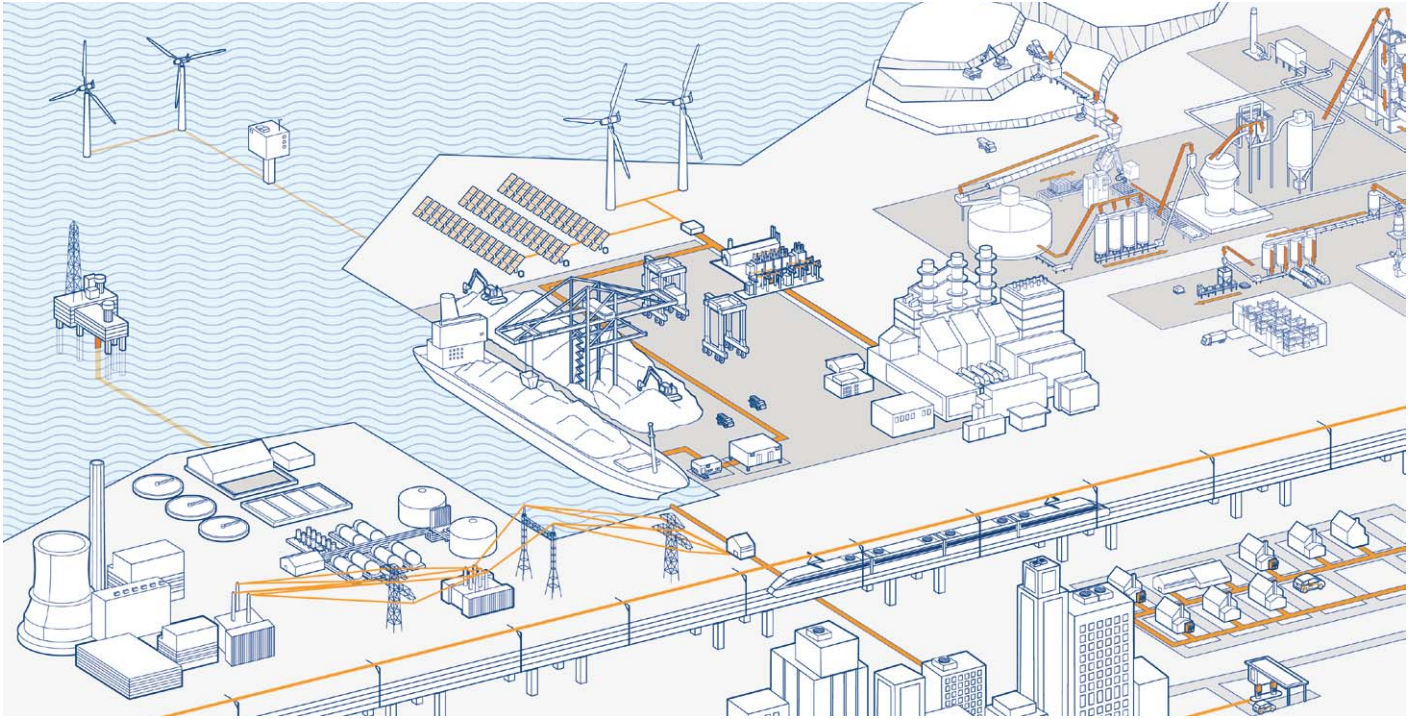

HVAC, General Machinery, Rail, Critical Power, Wind, Solar, Marine and Water & Wastewater

Contactors for any use

The AF contactor range covers small motor starting solutions from 4 kW / 5 hp up to big power switching solutions with our unique AF2650, the biggest single case block contactor in the world.

The contactor and motor protection range is part of one of the widest product offerings on the market meaning that ABB not only can provide the contactor but the full solution.

In addition to the standard product range ABB also offer products for special needs such as Bar contactors, GAF and contactors for capacitor switching.

Cooperating with customers

ABB cooperates closely with its customers to ensure that products meet requirements from their specific segments and applications. With over 100 years' experience in motor control and power switching ABB knows how to create efficient solutions for its customers.

AF technology

Benefits



Reliable in all networks

The electronic system within the AF contactor rectifies the AC or DC control circuit voltage to a DC control voltage that is applied on the coil. The contactor is safely operated in an always optimized condition making it virtually noise free.

Four coils for the entire voltage range

The AF contactor features both AC and DC support. With the complete AF contactor range, functionality is improved. Still, the total number of product variants compared to a conventional range is reduced by 90 %. Only four coils are required to cover 24 V AC, 20 V DC - 500 V AC / DC.

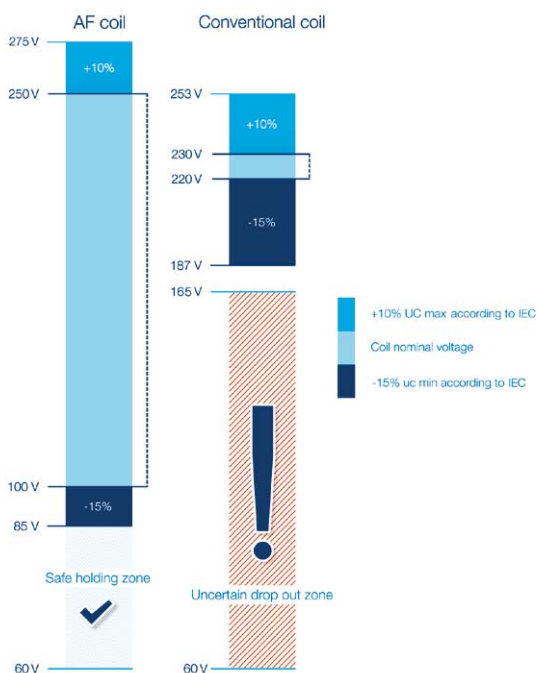

Wide control voltage range

With conventional contactor technology, different contactors were needed for different network voltages. Thanks to the wide operating range of the AF contactor it can operate just as well in Europe as in Asia or North America. The core coil of the AF contactor range covers 100-250 V AC / DC 50/60 Hz.



Built-in surge suppression

With conventional contactor technology it is recommended to use an external surge suppressor, an accessory that could cost as much as half the contactor itself. With the AF technology the surges are handled by the contactor itself and the surge never reaches the control circuit. Neither the surge suppressor nor the actual surge has to be considered anymore. One less product and one less complication to worry about.

Contactors and motor protection

Advanced but simple

1

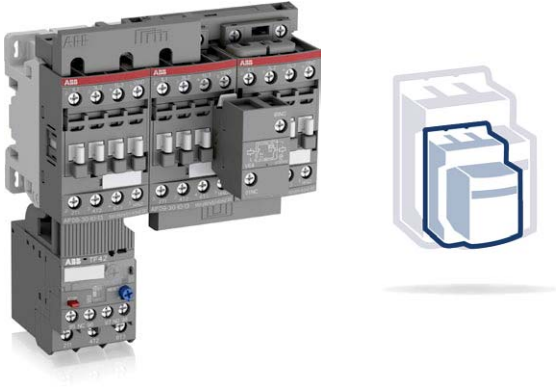

The AF contactor is compact

The AF contactor is compact in size and has had its width reduced by up to 30 % thanks to an 80 % reduction of the coil's energy consumption.



The AF contactor is flexible

AF09 ... AF370 is perfect for motor starting applications and for solutions where space is limited. Interlocked reversing pairs require no spacing between contactors meaning you can fit more functionality into cabinets or other small enclosures.



Coil terminal access in the front

The AF contactor has its coil terminals accessible from the front. The cables or bars do not have to be disconnected in order to perform voltage measurement or servicing work.



More functionality without adding width

The AF116 ... AF2650 can take up to 2 side mounted auxiliary contact blocks without adding to its width and are delivered with 1 N.O. + 1 N.C. as standard.

Contactors and motor protection

Mechanical features

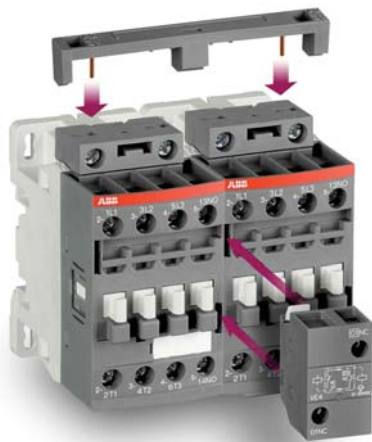

Top-mounted



Bottom-mounted

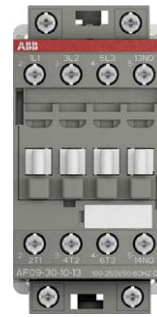

Additional LDC4
coil terminal block



Front-mounted

Easy-to-use accessories

Contactors up to 96 A offer free choice of coil terminal access and can take side and front mounted auxiliary contact blocks. All the accessories: Coil connection terminals, mechanical and electrical interlocks and electronic timers are easily connected through the snap-to-connect function.



Safe control circuit with:

- Mirror contact according to IEC 60947-4-1
- Mechanically linked contacts according to IEC 60947-5-1
- Sealable and transparent protective covers on AF09 ... AF96 and overload relays TF/EF

3-pole contactors

Mini contactors

Contactors for motor control and

1



IEC (1)	AC-3 Rated operational power	$\theta \leq 60^\circ\text{C}$ (2), 400 V	kW	4	5.5
UL/CSA	3-phase motor rating	480 V	hp	3	5
AC / DC Control supply		Type	—	—	—
AC Control supply		Type	B6	B7	—
DC Control supply		Type	BC6	BC7	—
IEC	AC-3 Rated operational current	$\theta \leq 60^\circ\text{C}$ (2), 400 V	A	8.5	11.5
	AC-1 Rated operational current	$\theta \leq 40^\circ\text{C}$, 690 V	A	20 (400 V)	20 (400 V)
UL/CSA	General use rating	600 V	A	12 (300 V)	16
NEMA	NEMA Size			—	—

4	5.5	7.5	4	5.5	7.5	11	15	18.5
5	7.5	10	5	7.5	10	15	20	25
—	—	—	AF09	AF12	AF16	AF26	AF30	AF38
AS09	AS12	AS16	AF09	AF12	AF16	AF26	AF30	AF38
ASL09	ASL12	ASL16	AF09	AF12	AF16	AF26	AF30	AF38
9	12	15.5	9	12	18	26	32	38
22	24	24	25	28	30	45	50	50
20	20	20	25	28	30	45	50	50
00	00	0	00	0	—	1	—	—

(1) 1000 V IEC ratings available for AF80, AF96 and AF146 ... AF2650 contactors.
 (2) $\theta \leq 55^\circ\text{C}$ for mini contactors and AF400 ... AF2650 contactors.

Main accessories

Auxiliary contact blocks	Front mounting	CAF6
	Side mounting	CA6
Timers	Electronic	
	Mechanical	
Interlocking units (3)	Mechanical / Electrical	
Connection sets	For reversing contactors	BSM6-30
Surge suppressors	Varistor (AC/DC)	RV-BC6
	RC type (AC)	
	Transil diode (DC)	RD7

CA3-10 (1 x N.O.)	CA4-10 (1 x N.O.)	
CA3-01 (1 x N.C.)	CA4-01 (1 x N.C.)	
	CAL4-11 (1 x N.O. + 1 x N.C.)	
TEF3-ON	TEF4-ON	
TEF3-OFF	TEF4-OFF	
VM3	VM4	
	VEM4	
BER16C-3	BER16-4	BER38-4
RV5 (24...440 V)	Built-in surge protection	
RC5-1 (24...440 V)		
RT5 (12...264 V)		

(3) See available reversing contactors VB6, VB7 and VAS09 ... VAS16.

Overload relays

Thermal relays	Class 10 (Class 10A for TF140, TA200DU)	T16 (0.10...16 A)
Electronic relays	Class 10E, 20E, 30E	E16DU (0.10...18.9 A)

T16 (0.10...16 A)	TF42 (0.10...38 A)		
	EF19 (0.10...18.9 A)	EF19 (0.10...18.9 A)	EF45 (9...45 A)

Manual motor starters

Thermal / magnetic protection Class 10	MS116 (0.10...32 A) lcs up to 50 kA for class 10A
	MS132 (0.10...32 A) lcs up to 100 kA
Magnetic only types	MO132 (0.16...32 A)

MS116 (0.10...32 A) lcs up to 50 kA for class 10A	MS165 (4) (10...65 A) lcs up to 100 kA
MS132 (0.10...32 A) lcs up to 100 kA	MS497 (22...100 A) lcs up to 100 kA
MO132 (0.16...32 A) lcs up to 100 kA	MO165 (4) (16...65 A) lcs up to 100 kA



Accessories	For contactor mounting	BEA7/132	BEA16-3	BEA16-4	BEA38-4
-------------	------------------------	----------	---------	---------	---------

(4) MS165/MO165 are suitable for use with AF09 ... AF30 for North american applications.
 (5) BEA65-4 suitable for MS165 and MO165 only.

4-pole contactors

Mini contactors

1



IEC	AC-1 Rated operational current	$\theta \leq 40^\circ\text{C}$, 690 V	A	16	20
UL/CSA	General use rating	600 V	A	12 (300 V)	16
AC / DC Control supply			Type	—	—
AC Control supply			Type	B6	B7
DC Control supply			Type	BC6	BC7

Contactor relays

Mini contactor relays



IEC	AC-15 Rated operational current	400 V	A	3
UL/CSA	Pilot duty			A600
AC Control supply			Type	K6-22Z K6-31Z K6-40E
DC Control supply			Type	KC6-22Z KC6-31Z KC6-40E
AC / DC Control supply			Type	— — —

R contactors

DC Circuit switching



DC-1 Rated current up to 5000 A
 DC-3/DC-5 Rated current up to 2000 A
 1500 V with poles in series

IOR.. 63-...-CC to IOR.. 5100-...-CC

Specific contactors

DC Circuit switching



100 A, 440 V, DC-1
GA75, GAE75 types



275 to 2050 A, 1000 V, DC-1
GAF185 to GAF2050 types

Contactors



25	30	45	55	70	100	125	160	200	275	350	400	500	525	800	1000
25	30	45	55	60	80	105	160	175	230	250	300	350	420	540	—
AF09	AF16	AF26	AF38	AF40	AF52	AF80	AF116	AF140	AF190	AF205	AF265	AF305	AF370	—	—
AF09	AF16	AF26	AF38	AF40	AF52	AF80	AF116	AF140	AF190	AF205	AF265	AF305	AF370	EK550	EK1000
AF09	AF16	AF26	AF38	AF40	AF52	AF80	AF116	AF140	AF190	AF205	AF265	AF305	AF370	EK550	EK1000

Contactor relays



3			3		
A600, Q300			A600, Q600		
NS22E	NS31E	NS40E	NF22E	NF31E	NF40E
NSL22E	NSL31E	NSL40E	NF22E	NF31E	NF40E
—	—	—	NF22E	NF31E	NF40E

AC Circuit switching

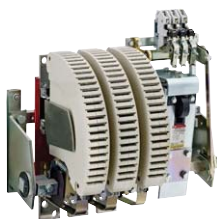

AC-1 Rated current up to 5000 A
AC-3 Rated power up to 1500 kW
(1520 A - 440 V)

IOR.. 63-...-MT to IOR.. 5100-...-MT

Special versions

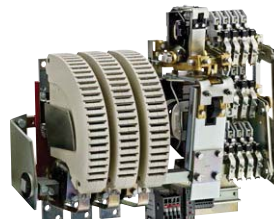

AC/DC Coupling: LOR.. contactors
Slip ring motor control: FOR .. contactors
Field discharge: AM(F)-CC-JORE contactors
AC/DC Switching (N.C./N.O. main poles):
NOR & JOR contactors
Latching contactors for energy saving
and safety requirements: AMA or AME contactors

Capacitor switching



12.5 to 80 kvar
UA16..RA to UA110..RA types
UA16 to UA110 types

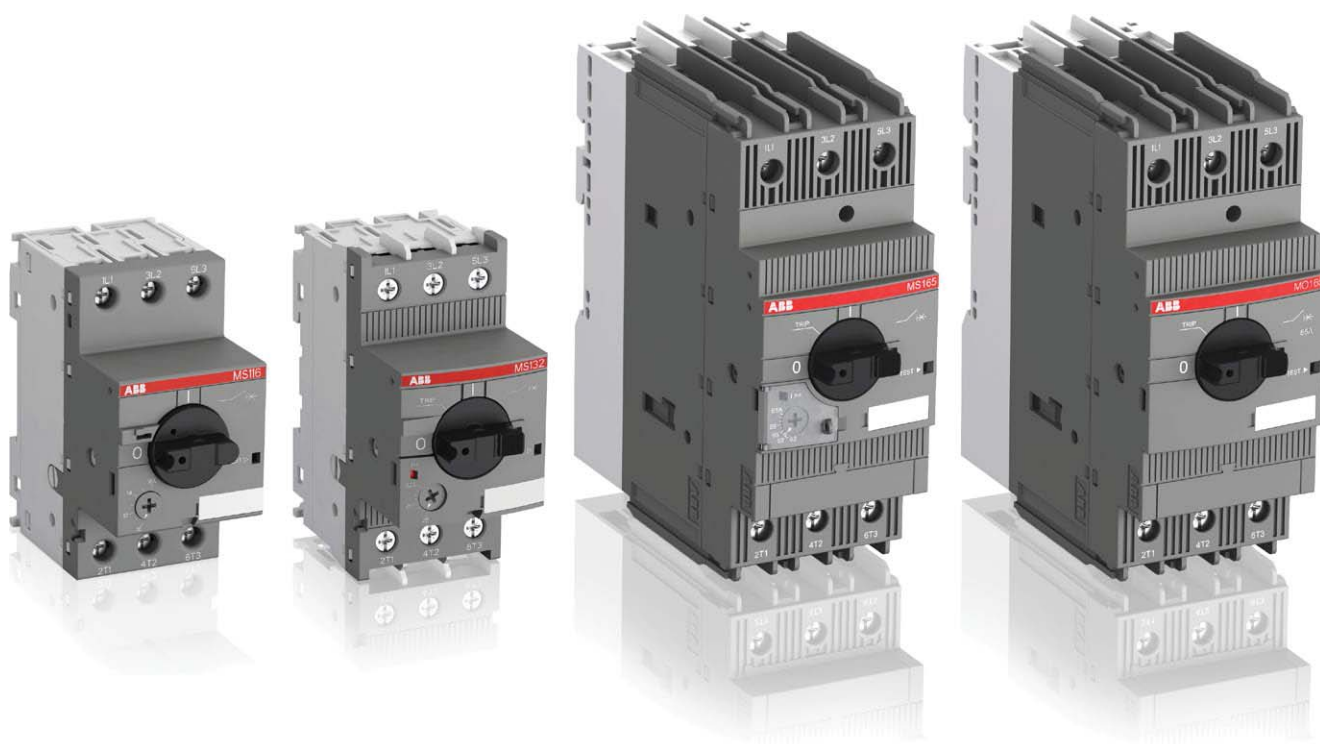

Manual motor starters

Overview	
Benefits	2/2
Features	2/3
Overview	2/4
<hr/>	
0.10 to 65 A – with thermal and electromagnetic protection	
MS116 manual motor starters	2/6
MS132 manual motor starters	2/7
MS165 manual motor starters	2/8
<hr/>	
0.16 to 65 A – with electromagnetic protection	
MO132 manual motor starters magnetic only	2/9
MO165 manual motor starters magnetic only	2/10
<hr/>	
0.10 to 25 A – with thermal and electromagnetic protection	
MS132-T circuit breakers for transformer protection	2/11
<hr/>	
Technical data	2/12
<hr/>	
Main accessories	2/22
<hr/>	
22 to 100 A – with thermal and electromagnetic protection	
MS5100, MS495, MS497 manual motor starters	2/32
<hr/>	
Technical data	2/33
<hr/>	
32 to 100 A – with electromagnetic protection	
MO5100, MO495, MO496 manual motor starters magnetic only	2/37
<hr/>	
Technical data	2/38
<hr/>	
Main accessories	2/42
<hr/>	
General accessories	2/47

Manual motor starters

Benefits

2

Manual motor starters (MMS) are protection devices for the main circuit. They combine motor control and protection in a single device. MMS are used mainly to switch motors manually ON/OFF and protect them and the installation fuse-less against short-circuit, overload and phase failures. Fuse-less protection with a manual motor starter saves costs, space and ensures a quick reaction under short-circuit condition, by switching off the motor within milliseconds.

Safe, compact, and cost-saving solution

Various motor protection functions in one device

- Overload
- Short-circuit
- Phase loss sensitivity

Efficient planning and installation perfectly matching the ABB contactor family, leads to high flexibility and increased exchangeability. Simple connecting links ensure the electrical and mechanical connection.

Products range for different applications available

- Short-circuit breaking capacity up to 100 kA
- Magnetic-only devices (only short-circuit protection)
- Selected types are certified according to ATEX
- Special version for transformer protection

The manual motor starter range is compatible with all major national and international standards.



Product range

Comprehensive accessory range

Manual motor starters can be equipped with busbars, auxiliary contacts, signalling contacts, undervoltage releases and shunt trips. Moreover it is possible to order IP65 (UL/CSA Type 12) door mounting kits, IP65 (UL/CSA Type 12) enclosures and shafts for doors.

MS116, MS132, MS165, MO132, MO165 and MS132-T share almost the same accessory range. Customers can optimize administration costs and inventory costs through reduced number of order codes by benefiting from a compatible range of accessories.



Manual motor starters with busbar connection



Accessory range



Direct-on-line starters



Door mounting kits

Manual motor starters

Features

Features

- Manual control
- Disconnect function
- Handle can be locked in the off position
- Remote control via undervoltage release or shunt trip
- Trip indication
- Temperature compensation
- Adjustable current setting

- Magnetic trip indication for several types available (MS132, MS165, and MS132-T)
- One product family in 45 mm width (MS116, MS132, MO132, and MS132-T)
- Variants from 0.1 up to 100 A available
- Short-circuit service breaking capacity I_{CS} up to 100 kA

- 1 Terminals (1L1, 3L2, 5L3)
- 2 Switch position TRIP
- 3 Lockable handle
- 4 Test function
- 5 Status indication for short-circuit
- 6 Current setting range
- 7 Terminals 2T1, 4T2, 6T3

- 1 Clear trip indication
- 2 Handle in TRIP position
- 3 Optical indication for short-circuit
- 4 Easy locking

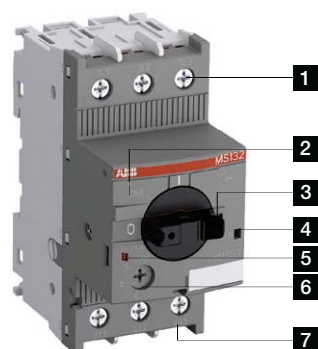

Features of type MS132

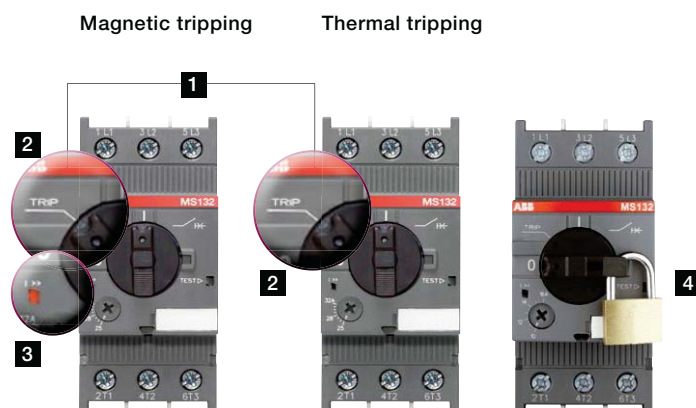

TRIP indication

2CDC131072C0201

Manual motor starters

Overview

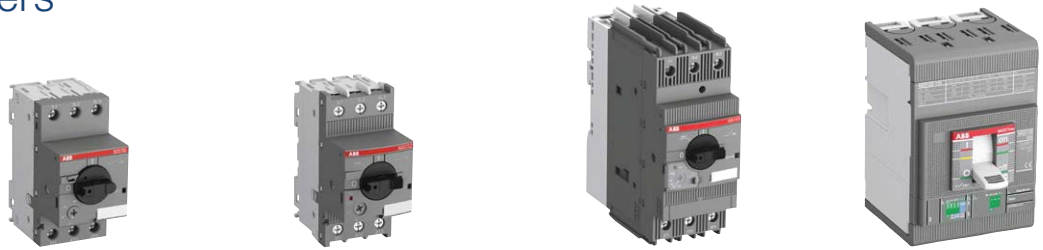

Type	MS116	MS132	MS165	MS5100
Thermal and electromagnetic protection	Yes	Yes	Yes	Yes
Electromagnetic protection	-	-	-	-
Phase loss sensitivity	Yes	Yes	Yes	-
Switch position	ON/OFF	ON/OFF/TRIP	ON/OFF/TRIP	ON/OFF/TRIP
Magnetic trip indication	-	Yes	Yes	-
Lockable handle without accessories	-	Yes	Yes	Yes
Disconnecting feature	Yes	Yes	Yes	Yes
Width	45 mm	45 mm	55 mm	90 mm
Rated operational current I_n	0.16 ... 32 A	0.16 ... 32 A	16 ... 65 A	100 A
Setting range	0.1 ... 32 A	0.1 ... 32 A	10 ... 65 A	40 ... 100 A ²⁾
Ambient air temperature	-25 ... +55 °C ¹⁾	-25 ... +60 °C ¹⁾	-20 ... +60 °C ¹⁾	-25 ... +70 °C

¹⁾ Compensated

²⁾ For motor loads only up to 80 A

Accessories

Auxiliary contact	HKF1, HK1		AUX
Signalling contact for tripped alarm	SK1		-
Signalling contact for short-circuit alarm	-	CK1	-
Shunt trip	AA1		SOR-C
Undervoltage release	UA1		UVR-C

Table for short-circuit ratings for 400/415 V

	Standard range MS116	Performance range MS132, MS165, MS5100
--	-------------------------	---

Selection parameters

Rated operational power	Setting range for thermal release	Type	Short-circuit breaking capacity		Type	Short-circuit breaking capacity	
			I_{cu}	I_{cs}		I_{cu}	I_{cs}
0.03 kW ¹⁾	0.1 ... 0.16 A	MS116-0.16	50 kA	50 kA	MS132-0.16	100 kA	100 kA
0.06 kW	0.16 ... 0.25 A	MS116-0.25	50 kA	50 kA	MS132-0.25	100 kA	100 kA
0.09 kW	0.25 ... 0.4 A	MS116-0.4	50 kA	50 kA	MS132-0.4	100 kA	100 kA
0.18 kW	0.4 ... 0.63 A	MS116-0.63	50 kA	50 kA	MS132-0.63	100 kA	100 kA
0.25 kW	0.63 ... 1.0 A	MS116-1.0	50 kA	50 kA	MS132-1.0	100 kA	100 kA
0.55 kW	1.0 ... 1.6 A	MS116-1.6	50 kA	50 kA	MS132-1.6	100 kA	100 kA
0.75 kW	1.6 ... 2.5 A	MS116-2.5	50 kA	50 kA	MS132-2.5	100 kA	100 kA
1.5 kW	2.5 ... 4.0 A	MS116-4.0	50 kA	50 kA	MS132-4.0	100 kA	100 kA
2.2 kW	4.0 ... 6.3 A	MS116-6.3	50 kA	50 kA	MS132-6.3	100 kA	100 kA
4.0 kW	6.3 ... 10 A	MS116-10	50 kA	50 kA	MS132-10	100 kA	100 kA
5.5 kW	8 ... 12 A	MS116-12	25 kA	25 kA	MS132-12	100 kA	100 kA
7.5 kW	10 ... 16 A	MS116-16	16 kA	16 kA	MS132-16 / MS165-16	100 kA	100 kA
7.5 kW	14 ... 20 A				MS165-20	100 kA	100 kA
7.5 kW	16 ... 20 A	MS116-20	15 kA	10 kA	MS132-20	100 kA	100 kA
11 kW	18 ... 25 A				MS165-25	100 kA	100 kA
11 kW	20 ... 25 A	MS116-25	15 kA	10 kA	MS132-25	50 kA	50 kA
15 kW	25 ... 32 A	MS116-32	10 kA	10 kA	MS132-32	50 kA	25 kA
15 kW	23 ... 32 A				MS165-32	100 kA	75 kA
22 kW	30 ... 42 A				MS165-42	50 kA	25 kA
22 kW	40 ... 54 A				MS165-54	50 kA	25 kA
25 kW	-						
30 kW	52 ... 65 A				MS165-65	50 kA	25 kA
37 kW	40 ... 100 A				MS5100-100	70 kA	70 kA
45 kW	40 ... 100 A				MS5100-100	70 kA	70 kA

¹⁾ 690 V



MO132	MO165	MO5100	MS132-T
-	-	-	Yes
Yes	Yes	Yes	-
-	-	-	Yes
ON/OFF/TRIP	ON/OFF/TRIP	ON/OFF/TRIP	ON/OFF/TRIP
-	-	-	Yes
Yes	Yes	Yes	Yes
Yes	Yes	Yes	Yes
45 mm	55 mm	76.2 mm	45 mm
0.16 ... 32 A	16 ... 65 A	70 ... 100 A	0.16 ... 32 A
-	-	-	0.1 ... 25 A
-25 ... +60 °C	-25 ... +60 °C	-25 ... +70 °C	-25 ... +60 °C ¹⁾

HKF1, HK1	AUX	HKF1
SK1	-	SK1
-	-	CK1
AA1	SOR-C	AA1
UA1	UVR-C	UA1

Standard range MO132	Performance range MO132, MO165, MO5100	Transformer protection MS132-T
-------------------------	---	-----------------------------------

Type	Short-circuit breaking capacity		Type	Short-circuit breaking capacity		Type	Short-circuit breaking capacity
	I_{CU}	I_{CS}		I_{CU}	I_{CS}		
MO132-0.16	100 kA	100 kA	MO132-0.16	100 kA	100 kA	MS132-0.16T	100 kA
MO132-0.25	100 kA	100 kA	MO132-0.25	100 kA	100 kA	MS132-0.25T	100 kA
MO132-0.4	100 kA	100 kA	MO132-0.4	100 kA	100 kA	MS132-0.4T	100 kA
MO132-0.63	100 kA	100 kA	MO132-0.63	100 kA	100 kA	MS132-0.63T	100 kA
MO132-1.0	100 kA	100 kA	MO132-1.0	100 kA	100 kA	MS132-1.0T	100 kA
MO132-1.6	100 kA	100 kA	MO132-1.6	100 kA	100 kA	MS132-1.6T	100 kA
MO132-2.5	100 kA	100 kA	MO132-2.5	100 kA	100 kA	MS132-2.5T	100 kA
MO132-4.0	100 kA	100 kA	MO132-4.0	100 kA	100 kA	MS132-4.0T	100 kA
MO132-6.3	100 kA	100 kA	MO132-6.3	100 kA	100 kA	MS132-6.3T	100 kA
MO132-10	100 kA	100 kA	MO132-10	100 kA	100 kA	MS132-10T	100 kA
MO132-12	100 kA	100 kA	MO132-12	100 kA	100 kA	MS132-12T	100 kA
MO132-16	100 kA	100 kA	MO132-16 / MO165-16	100 kA	100 kA	MS132-16T	100 kA
			MO165-20	100 kA	100 kA		
MO132-20	100 kA	100 kA	MO132-20	100 kA	100 kA	MS132-20T	100 kA
MO132-25	50 kA	50 kA	MO132-25 / MO165-25	50 kA / 100 kA	50 kA / 100 kA	MS132-25T	50 kA
MO132-32	50 kA	25 kA	MO132-32	50 kA	25 kA	Transformer protection: The instantaneous short-circuit current setting is 20 times the rated operational current.	
			MO165-32	100 kA	50 kA		
			MO165-42	50 kA	25 kA		
			MO165-54	50 kA	25 kA		
			MO5100-70	36 kA	36 kA		
			MO165-65	50 kA	25 kA		
			MO5100-80	36 kA	36 kA		
			MO5100-100	36 kA	36 kA		

MS116 manual motor starters

0.10 to 32 A – with thermal and electromagnetic protection

2



2CDC241010F0011

MS116-16



2CDC2410011F0011

MS116-25



2CDC241013F0011

MS116-0.16-HKF1-11



2CDC241012F0011

MS116-32-HKF1-11

Description

MS116 is a compact and economic range for motor protection up to 15 kW (400 V) / 32 A in width of 45 mm. Further features are the build-in disconnect function, temperature compensation, trip-free mechanism and a rotary handle with a clear switch position indication. The manual motor starter is suitable for three- and single-phase applications. Auxiliary contacts, signaling contacts, undervoltage releases, shunt trips, power in-feed blocks and locking devices for protection against unauthorized changes are available as accessory. These are suitable throughout the MS116/MS132/MS165-range.

Ordering details

Rated operational power 400 V AC-3 kW	Setting range A	Short-circuit breaking capacity I_{cs} at 400 V AC kA	Rated instantaneous short-circuit current setting I_i A	Type	Order code	Weight (1 pc) kg
0.03 ²⁾	0.10 ... 0.16	50	2.00 ¹⁾	MS116-0.16	1SAM250000R1001	0.225
0.06	0.16 ... 0.25	50	3.10 ¹⁾	MS116-0.25	1SAM250000R1002	0.225
0.09	0.25 ... 0.40	50	5.00 ¹⁾	MS116-0.4	1SAM250000R1003	0.225
0.18	0.40 ... 0.63	50	7.90 ¹⁾	MS116-0.63	1SAM250000R1004	0.225
0.25	0.63 ... 1.00	50	12.5 ¹⁾	MS116-1.0	1SAM250000R1005	0.225
0.55	1.00 ... 1.60	50	20.0 ¹⁾	MS116-1.6	1SAM250000R1006	0.265
0.75	1.60 ... 2.50	50	31.3 ¹⁾	MS116-2.5	1SAM250000R1007	0.265
1.50	2.50 ... 4.00	50	50.0	MS116-4.0	1SAM250000R1008	0.265
2.20	4.00 ... 6.30	50	78.8	MS116-6.3	1SAM250000R1009	0.265
4.00	6.30 ... 10.0	50	150	MS116-10	1SAM250000R1010	0.265
5.50	8.00 ... 12.0	25	180	MS116-12	1SAM250000R1012	0.265
7.50	10.0 ... 16.0	16	240	MS116-16	1SAM250000R1011	0.265
7.50	16.0 ... 20.0	10	300	MS116-20	1SAM250000R1013	0.310
11.0	20.0 ... 25.0	10	375	MS116-25	1SAM250000R1014	0.310
15.0	25.0 ... 32.0	10	480	MS116-32	1SAM250000R1015	0.310
0.03 ²⁾	0.10 ... 0.16	50	2.00 ¹⁾	MS116-0.16-HKF1-11	1SAM250005R1001	0.240
0.06	0.16 ... 0.25	50	3.10 ¹⁾	MS116-0.25-HKF1-11	1SAM250005R1002	0.240
0.09	0.25 ... 0.40	50	5.00 ¹⁾	MS116-0.4-HKF1-11	1SAM250005R1003	0.240
0.18	0.40 ... 0.63	50	7.90 ¹⁾	MS116-0.63-HKF1-11	1SAM250005R1004	0.240
0.25	0.63 ... 1.00	50	12.5 ¹⁾	MS116-1.0-HKF1-11	1SAM250005R1005	0.240
0.55	1.00 ... 1.60	50	20.0 ¹⁾	MS116-1.6-HKF1-11	1SAM250005R1006	0.280
0.75	1.60 ... 2.50	50	31.3 ¹⁾	MS116-2.5-HKF1-11	1SAM250005R1007	0.280
1.50	2.50 ... 4.00	50	50.0	MS116-4.0-HKF1-11	1SAM250005R1008	0.280
2.20	4.00 ... 6.30	50	78.8	MS116-6.3-HKF1-11	1SAM250005R1009	0.280
4.00	6.30 ... 10.0	50	150	MS116-10.0-HKF1-11	1SAM250005R1010	0.280
5.50	8.00 ... 12.0	25	180	MS116-12.0-HKF1-11	1SAM250005R1012	0.280
7.50	10.0 ... 16.0	16	240	MS116-16.0-HKF1-11	1SAM250005R1011	0.280
7.50	16.0 ... 20.0	10	300	MS116-20-HKF1-11	1SAM250005R1013	0.326
11.0	20.0 ... 25.0	10	375	MS116-25-HKF1-11	1SAM250005R1014	0.326
15.0	25.0 ... 32.0	10	480	MS116-32-HKF1-11	1SAM250005R1015	0.326

Note: Manual motor starters should always be selected so that the actual motor current is within the setting range.

¹⁾ The data is valid for products, produced after week 34, 2014.

²⁾ 690 V

Main dimensions mm, inches

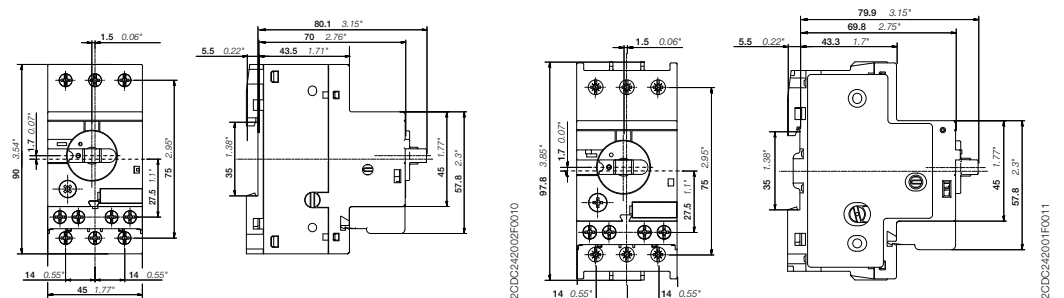

MS116 ≤ 16 A & MS116-HKF1-11 ≤ 16 A

MS116 ≥ 20 A & MS116-HKF1-11 ≥ 20 A

MS132 manual motor starters

0.10 to 32 A – with thermal and electromagnetic protection



1SBC101232F0010

MS132-10



2CDC241001F0011

MS132-32



2CDC241014F0011

MS132-0.16-HKF1-11



2CDC241015F0011

MS132-32-HKF1-11

Description

MS132 is a compact and powerful range for motor protection up to 15 kW (400 V) / 32 A in width of 45 mm. This type has also a clear and reliable indication of fault in a separate window in the event of short-circuit tripping. Further features are the build-in disconnect function, temperature compensation, trip-free mechanism and a rotary handle with a clear switch position indication. The manual motor starter is suitable for three- and single-phase applications. The handle is lockable to protect against unauthorized changes. Auxiliary contacts, signaling contacts, undervoltage releases, shunt trips, power in-feed blocks are available as accessory. These are suitable throughout the MS116/MS132/MS165-range.

Ordering details

Rated operational power 400 V AC-3	Setting range	Short-circuit breaking capacity I_{cs} at 400 V AC	Rated instantaneous short-circuit current setting I_i	Type	Order code	Weight (1 pc)
0.03 ²⁾	0.10 ... 0.16	100	2.00 ¹⁾	MS132-0.16	1SAM350000R1001	0.215
0.06	0.16 ... 0.25	100	3.10 ¹⁾	MS132-0.25	1SAM350000R1002	0.215
0.09	0.25 ... 0.40	100	5.00 ¹⁾	MS132-0.4	1SAM350000R1003	0.215
0.18	0.40 ... 0.63	100	7.90 ¹⁾	MS132-0.63	1SAM350000R1004	0.215
0.25	0.63 ... 1.00	100	12.5 ¹⁾	MS132-1.0	1SAM350000R1005	0.215
0.55	1.00 ... 1.60	100	20.0 ¹⁾	MS132-1.6	1SAM350000R1006	0.265
0.75	1.60 ... 2.50	100	31.3 ¹⁾	MS132-2.5	1SAM350000R1007	0.265
1.50	2.50 ... 4.00	100	50.0	MS132-4.0	1SAM350000R1008	0.265
2.20	4.00 ... 6.30	100	78.8	MS132-6.3	1SAM350000R1009	0.265
4.00	6.30 ... 10.0	100	150	MS132-10	1SAM350000R1010	0.265
5.50	8.00 ... 12.0	100	180	MS132-12	1SAM350000R1012	0.310
7.50	10.0 ... 16.0	100	240	MS132-16	1SAM350000R1011	0.310
7.50	16.0 ... 20.0	100	300	MS132-20	1SAM350000R1013	0.310
11.0	20.0 ... 25.0	50	375	MS132-25	1SAM350000R1014	0.310
15.0	25.0 ... 32.0	25	480	MS132-32	1SAM350000R1015	0.310
0.03 ²⁾	0.10 ... 0.16	100	2.00 ¹⁾	MS132-0.16-HKF1-11	1SAM350005R1001	0.231
0.06	0.16 ... 0.25	100	3.10 ¹⁾	MS132-0.25-HKF1-11	1SAM350005R1002	0.231
0.09	0.25 ... 0.40	100	5.00 ¹⁾	MS132-0.4-HKF1-11	1SAM350005R1003	0.231
0.18	0.40 ... 0.63	100	7.90 ¹⁾	MS132-0.63-HKF1-11	1SAM350005R1004	0.231
0.25	0.63 ... 1.00	100	12.5 ¹⁾	MS132-1.0-HKF1-11	1SAM350005R1005	0.231
0.55	1.00 ... 1.60	100	20.0 ¹⁾	MS132-1.6-HKF1-11	1SAM350005R1006	0.281
0.75	1.60 ... 2.50	100	31.3 ¹⁾	MS132-2.5-HKF1-11	1SAM350005R1007	0.281
1.50	2.50 ... 4.00	100	50.0	MS132-4.0-HKF1-11	1SAM350005R1008	0.281
2.20	4.00 ... 6.30	100	78.8	MS132-6.3-HKF1-11	1SAM350005R1009	0.281
4.00	6.30 ... 10.0	100	150	MS132-10.0-HKF1-11	1SAM350005R1010	0.281
5.50	8.00 ... 12.0	100	180	MS132-12.0-HKF1-11	1SAM350005R1012	0.326
7.50	10.0 ... 16.0	100	240	MS132-16.0-HKF1-11	1SAM350005R1011	0.326
7.50	16.0 ... 20.0	100	300	MS132-20-HKF1-11	1SAM350005R1013	0.326
11.0	20.0 ... 25.0	50	375	MS132-25-HKF1-11	1SAM350005R1014	0.326
15.0	25.0 ... 32.0	25	480	MS132-32-HKF1-11	1SAM350005R1015	0.326

Note: Manual motor starters should always be selected so that the actual motor current is within the setting range.

¹⁾ The data is valid for products, produced after week 34, 2014.

²⁾ 690 V

Main dimensions mm, inches

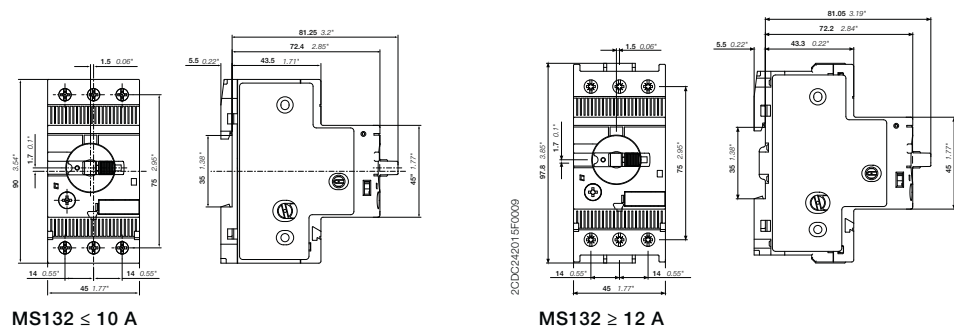

MS165 manual motor starters

10 to 65 A – with thermal and electromagnetic protection

2



MS165-65

2CDC241004V0015

Description

MS165 is a compact and powerful range for motor protection up to 30 kW (400 V) / 65 A in width of 55 mm. This type has also a clear and reliable indication of fault in a separate window in the event of short-circuit tripping. Further features are the build-in disconnect function, temperature compensation, trip-free mechanism and a rotary handle with a clear switch position indication. The manual motor starter is suitable for three- and single-phase applications. The handle is lockable to protect against unauthorized changes. Auxiliary contacts, signaling contacts, undervoltage releases, shunt trips, power in-feed blocks are available as accessory. These are suitable throughout the MS116/MS132/MS165-range.

Ordering details

Rated operational power 400 V AC-3	Setting range	Short-circuit breaking capacity I_{cs} at 400 V AC	Rated instantaneous short-circuit current setting I_i	Type	Order code	Weight (1 pc)
kW	A	kA	A			kg
7.5	10 ... 16	100	240	MS165-16	1SAM451000R1011	0.950
7.5	14 ... 20	100	300	MS165-20	1SAM451000R1012	0.950
11	18 ... 25	100	375	MS165-25	1SAM451000R1013	0.960
15	23 ... 32	75	480	MS165-32	1SAM451000R1014	0.970
22	30 ... 42	25	630	MS165-42	1SAM451000R1015	0.970
22	40 ... 54	25	810	MS165-54	1SAM451000R1016	0.970
30	52 ... 65	25	975	MS165-65	1SAM451000R1017	0.980

Note: Manual motor starters should always be selected so that the actual motor current is within the setting range.

Main dimensions mm, inches

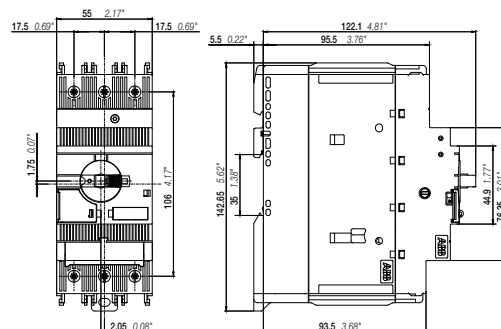

MS165

2CDC242001F0014

2CDC131062C0201

MO132 manual motor starters magnetic only 0.16 to 32 A – with electromagnetic protection



MO132-6.3

2CDC241008F0011



MO132-32

2CDC241008F0011

Description

Manual motor starters magnetic only are electromechanical protection devices for the main circuit. They are used mainly to switch motors manually ON/OFF and protect them fuse-less against short-circuit.

Fuse-less protection with a manual motor starter saves costs, space and ensures a quick reaction under short-circuit condition, by switching off the motor within milliseconds. Fuse-less starter combinations are setup together with contactors and overload relays.

Ordering details

Rated operational power 400 V AC-3 ¹⁾	Rated operational current	Short-circuit breaking capacity I_{cs} at 400 V AC	Rated instantaneous short-circuit current setting I_i	Type	Order code	Weight (1 pc)
kW	A	kA	A			kg
0.03 ³⁾	0.16	100	2.00 ²⁾	MO132-0.16	1SAM360000R1001	0.215
0.06	0.25	100	3.10 ²⁾	MO132-0.25	1SAM360000R1002	0.215
0.09	0.40	100	5.00 ²⁾	MO132-0.4	1SAM360000R1003	0.215
0.12	0.63	100	7.90 ²⁾	MO132-0.63	1SAM360000R1004	0.215
0.25	1.0	100	12.5 ²⁾	MO132-1.0	1SAM360000R1005	0.215
0.55	1.6	100	20.0 ²⁾	MO132-1.6	1SAM360000R1006	0.265
0.75	2.5	100	31.3 ²⁾	MO132-2.5	1SAM360000R1007	0.265
1.5	4.0	100	50.0	MO132-4.0	1SAM360000R1008	0.265
2.2	6.3	100	78.8	MO132-6.3	1SAM360000R1009	0.265
4.0	10	100	125	MO132-10	1SAM360000R1010	0.265
5.5	12	100	150	MO132-12	1SAM360000R1012	0.310
7.5	16	100	200	MO132-16	1SAM360000R1011	0.310
7.5	20	100	250	MO132-20	1SAM360000R1013	0.310
11	25	50	313	MO132-25	1SAM360000R1014	0.310
15	32	25	400	MO132-32	1SAM360000R1015	0.310

¹⁾ For overload protection of motors, an appropriate thermal or electronic overload relay must be used

²⁾ The data is valid for products, produced after week 34, 2014.

³⁾ 690 V

Main dimensions mm, inches

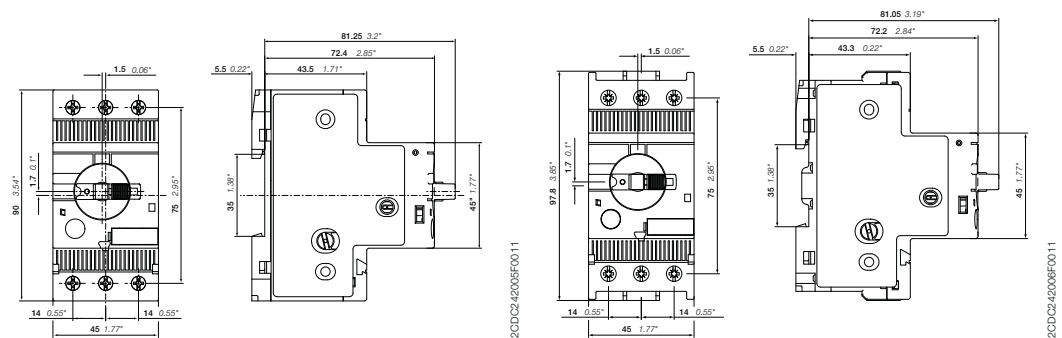

MO132 ≤ 10 A

MO132 ≥ 12 A

2CDC242005F0011

2CDC242006F0011

2CDC131062C0201

MO165 manual motor starters magnetic only 16 to 65 A – with electromagnetic protection

2



MO165-65

2CDC241005V0015

Description

Manual motor starters magnetic only are electromechanical protection devices for the main circuit. They are used mainly to switch motors manually ON/OFF and protect them fuse-less against short-circuit. Fuse-less protection with a manual motor starter saves costs, space and ensures a quick reaction under short-circuit condition, by switching off the motor within milliseconds. Fuse-less starter combinations are setup together with contactors and overload relays.

Ordering details

Rated operational power 400 V AC-3 kW	Rated operational current A	Short-circuit breaking capacity I_{cs} at 400 V AC kA	Rated instantaneous short-circuit current setting I_i A	Type	Order code	Weight (1 pc) kg
7.5	16	100	240	MO165-16	1SAM461000R1011	0.950
7.5	20	100	300	MO165-20	1SAM461000R1012	0.950
11	25	100	375	MO165-25	1SAM461000R1013	0.960
15	32	50	480	MO165-32	1SAM461000R1014	0.970
22	42	25	630	MO165-42	1SAM461000R1015	0.970
22	54	25	810	MO165-54	1SAM461000R1016	0.970
30	65	25	975	MO165-65	1SAM461000R1017	0.980

Main dimensions mm, inches

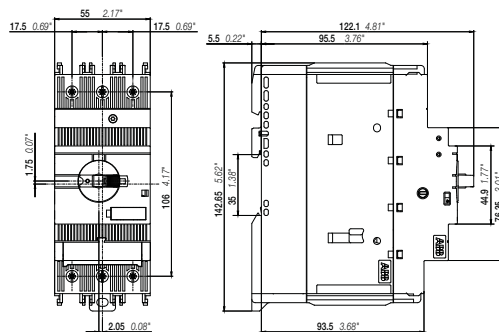

MO165

2CDC24002F0014

2CDC131062C0201

MS132-T circuit breakers for transformer protection

0.10 to 25 A – with thermal and electromagnetic protection



2CDC241001F0014

MS132-10T



2CDC241002F0014

MS132-25T

Description

Circuit breakers for transformer protection are electro mechanical protection devices specially designed to protect control transformers on the primary side. They allow fuse-less protection against overload and short-circuit, saving space and cost and ensuring a quick reaction under short-circuit condition by switching off the transformer within milliseconds. The short-circuit current setting is fixed to 20 times the operating current to handle the high inrush current generated by transformers. The device allows manual connection and disconnection of the transformer from the mains.

MS132-T is a 45 mm (width) compact and powerful range for transformer protection up to 12.5 kW (400 V) / 25 A. This type has also a clear and reliable indication of fault in a separate window in the event of short-circuit tripping. Further features are the build-in disconnect function, temperature compensation, trip-free mechanism and a rotary handle with a clear switch position indication. The handle is lockable to protect against unauthorized changes. Auxiliary contacts, signaling contacts, undervoltage releases, shunt trips, power in-feed blocks are available as accessory. These are suitable throughout the MS116/MS132/MS165-range. Moreover ABB offers special accessories for fast single-phase setup.

Ordering details

Setting range	Short-circuit breaking capacity I_{cs} at 400 V AC	Rated instantaneous short-circuit current setting I_i	Type	Order code	Weight (1 pc)
A	kA	A			kg
0.10 ... 0.16	100	3.2	MS132-0.16T	1SAM340000R1001	0.215
0.16 ... 0.25	100	5	MS132-0.25T	1SAM340000R1002	0.215
0.25 ... 0.40	100	8	MS132-0.4T	1SAM340000R1003	0.215
0.40 ... 0.63	100	12.6	MS132-0.63T	1SAM340000R1004	0.215
0.63 ... 1.00	100	20	MS132-1.0T	1SAM340000R1005	0.215
1.00 ... 1.60	100	32	MS132-1.6T	1SAM340000R1006	0.265
1.60 ... 2.50	100	50	MS132-2.5T	1SAM340000R1007	0.265
2.50 ... 4.00	100	80	MS132-4.0T	1SAM340000R1008	0.265
4.00 ... 6.30	100	126	MS132-6.3T	1SAM340000R1009	0.265
6.30 ... 10.0	100	200	MS132-10T	1SAM340000R1010	0.265
8.00 ... 12.0	100	240	MS132-12T	1SAM340000R1012	0.310
10.0 ... 16.0	100	320	MS132-16T	1SAM340000R1011	0.310
16.0 ... 20.0	100	400	MS132-20T	1SAM340000R1013	0.310
20.0 ... 25.0	50	500	MS132-25T	1SAM340000R1014	0.310

Please check for single-phase equipment chapter Main accessories.

Main dimensions mm, inches

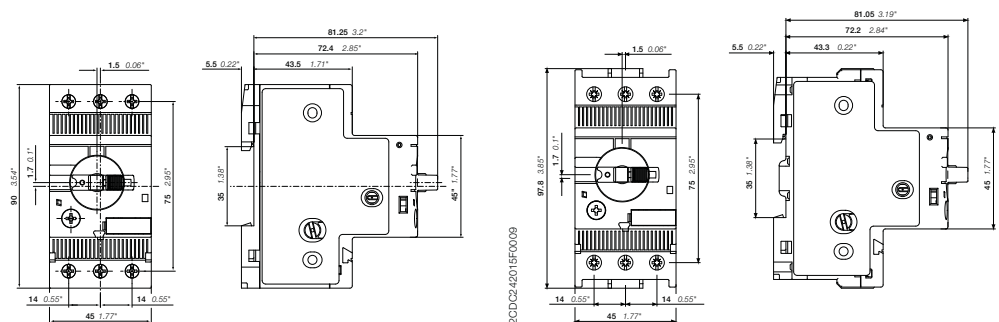

MS132T ≤ 10 A

MS132T ≥ 12 A

2CDC242015F0009

2CDC242016F0009

2CDC131062C0201

Technical data

MS116, MS132, MS165, MO132, MO165, MS132-T

Main circuit – Utilization characteristics according to IEC/EN

Type	MS116	MS132	MS165	MO132	MO165	MS132-T	
Standards	IEC/EN 60947-2, IEC/EN 60947-4-1, IEC/EN 60947-1						
Rated operational voltage U_e	690 V AC	690 V AC / 250 V DC	690 V AC	690 V AC	690 V AC	690 V AC	
Rated frequency	50/60 Hz	DC, 50/60 Hz	50/60 Hz	50/60 Hz	50/60 Hz	50/60 Hz	
Trip class	10A	10 (10A for 1SA M350000R1001)	10	-	-	10	
Number of poles	3						
Duty time	100 %						
Mechanical durability	100000 cycles	100000 cycles	50000 cycles	100000 cycles	50000 cycles	100000 cycles	
Electrical durability	up to 16 A	100000 cycles	50000 cycles	25000 cycles	50000 cycles	25000 cycles	50000 cycles
	20 ... 65 A	50000 cycles	50000 cycles	25000 cycles	50000 cycles	25000 cycles	50000 cycles
Rated impulse withstand voltage U_{imp}	6 kV	6 kV	8 kV	6 kV	8 kV	6 kV	
Rated insulation voltage U_i	690 V	690 V	1000 V	690 V	1000 V	690 V	
Rated operational current I_n	See ordering details						
Rated operational current DC-5 I_{DC-5} 3 conducting paths in series up to 250 V	-	See "Rated operational current I_n "	-	-	-	-	
Rated instantaneous short-circuit current setting I_{cs}	See ordering details						
Rated service short-circuit breaking capacity I_{cs}	See table "Short-circuit breaking capacity and back-up fuses"						
Rated ultimate short-circuit breaking capacity I_{cu}	See table "Short-circuit breaking capacity and back-up fuses"						
Rated service short-circuit breaking capacity DC I_{cs} 3 conducting paths in series up to 250 V	-	10 kA	-	-	-	-	

Short-circuit breaking capacity and back-up fuses

I_{cs} Rated service short-circuit breaking capacity

I_{cu} Rated ultimate short-circuit breaking capacity

I_{cc} Prospective short-circuit current at installation location

Note: Maximum rated current of the back-up fuses if $I_{cc} > I_{cs}$

Type	230 V AC			400 V AC			440 V AC			500 V AC			690 V AC		
	I_{cs} kA	I_{cu} kA	gG, aM A	I_{cs} kA	I_{cu} kA	gG, aM A	I_{cs} kA	I_{cu} kA	gG, aM A	I_{cs} kA	I_{cu} kA	gG, aM A	I_{cs} kA	I_{cu} kA	gG, aM A
MS116-0.16	No back-up fuse required up to $I_{cc} = 30$ kA														
MS116-0.25															
MS116-0.4															
MS116-0.63															
MS116-1.0															
MS116-1.6	No back-up fuse required up to $I_{cc} = 50$ kA														
MS116-2.5							10	10	25	10	10	25	5	5	25
MS116-4.0							6	6	25	6	6	25	2	2	25
MS116-6.3							6	6	63	6	6	63	2	2	40
MS116-10							6	6	63	6	6	63	2	2	50
MS116-12	25	25	80	25	25	80	6	6	63	6	6	63	2	2	50
MS116-16	16	16	80	16	16	80	6	6	63	4	4	63	2	2	63
MS116-20	10	15	125	10	15	125	3	6	125	3	4	125	2	2	80
MS116-25	10	15	125	10	15	125	3	6	125	3	4	125	2	2	100
MS116-32	10	10	125	10	10	125	3	6	125	3	4	125	2	2	100

MS116-10: No need for back-up fuse in networks with a prospective current of up to 50 kA at 400 V.

MS116-16: No need for back-up fuse in networks with a prospective current of up to 16 kA at 400 V.

With an appropriate 80 A type gG fuse the device can be used in a network with a prospective current of up to 100 kA.

MS116-32: No need for back-up fuse in networks with a prospective current of up to 10 kA at 400 V.

Technical data

MS116, MS132, MS165, MO132, MO165, MS132-T

Type	230 V AC			400 V AC			440 V AC			500 V AC			690 V AC		
	I_{CS} kA	I_{CU} kA	gG, aM A	I_{CS} kA	I_{CU} kA	gG, aM A	I_{CS} kA	I_{CU} kA	gG, aM A	I_{CS} kA	I_{CU} kA	gG, aM A	I_{CS} kA	I_{CU} kA	gG, aM A
MS132-0.16	No back-up fuse required up to $I_{cc} = 100$ kA														
MS132-0.25															
MS132-0.4															
MS132-0.63															
MS132-1.0															
MS132-1.6															
MS132-2.5															
MS132-4.0				20	20	35	20	20	35	20	20	35	3	3	32
MS132-6.3				20	20	63	20	20	63	20	20	63	3	3	50
MS132-10				20	20	100	20	20	100	20	20	100	3	3	50
MS132-12				20	20	100	20	20	100	20	20	100	3	3	63
MS132-16				20	20	125	20	20	125	20	20	125	3	3	63
MS132-20				20	20	125	20	20	125	20	20	125	3	3	80
MS132-25	50	50	125	50	50	125	20	20	125	10	10	125	3	3	100
MS132-32	25	50	125	25	50	125	20	20	125	10	10	125	3	3	100

MS132-16: No need for back-up fuse in networks with a prospective current of up to 100 kA at 400 V.

MS132-32: No need for back-up fuse in networks with a prospective current of up to 50 kA at 400 V.

With an appropriate 125 A type gG fuse the device can be used in a network with a prospective current of up to 100 kA.

Type	230 V AC			400 V AC			440 V AC			500 V AC			690 V AC		
	I_{CS} kA	I_{CU} kA	gG A	I_{CS} kA	I_{CU} kA	gG A	I_{CS} kA	I_{CU} kA	gG A	I_{CS} kA	I_{CU} kA	gG A	I_{CS} kA	I_{CU} kA	gG A
MS165-16	100	100	-	100	100	-	8	8	125	8	8	125	8	8	63
MS165-20	100	100	-	100	100	-	8	8	125	8	8	125	8	8	63
MS165-25	100	100	-	100	100	-	8	8	125	8	8	125	8	8	80
MS165-32	75	100	-	75	100	-	5	5	125	5	5	125	5	5	100
MS165-42	25	50	125	25	50	125	5	5	125	5	5	125	5	5	100
MS165-54	25	50	125	25	50	125	5	5	125	5	5	125	5	5	100
MS165-65	25	50	125	25	50	125	5	5	125	5	5	125	5	5	100

Type	230 V AC			400 V AC			440 V AC			500 V AC			690 V AC		
	I_{CS} kA	I_{CU} kA	gG, aM A	I_{CS} kA	I_{CU} kA	gG, aM A	I_{CS} kA	I_{CU} kA	gG, aM A	I_{CS} kA	I_{CU} kA	gG, aM A	I_{CS} kA	I_{CU} kA	gG, aM A
MO132-0.16	No back-up fuse required up to $I_{cc} = 100$ kA														
MO132-0.25															
MO132-0.4															
MO132-0.63															
MO132-1.0															
MO132-1.6															
MO132-2.5															
MO132-4.0				20	20	35	20	20	35	20	20	35	3	3	32
MO132-6.3				20	20	63	20	20	63	20	20	63	3	3	50
MO132-10				20	20	100	20	20	100	20	20	100	3	3	50
MO132-12				20	20	100	20	20	100	20	20	100	3	3	63
MO132-16				20	20	125	20	20	125	20	20	125	3	3	63
MO132-20				20	20	125	20	20	125	20	20	125	3	3	80
MO132-25	50	50	125	50	50	125	10	10	125	10	10	125	3	3	100
MO132-32	25	50	125	25	50	125	10	10	125	10	10	125	3	3	100

MO132-20: No need for back-up fuse in networks with a prospective current of up to 100 kA at 400 V.

MO132-32: No need for back-up fuse in networks with a prospective current of up to 50 kA at 400 V.

With an appropriate 125 A type gG fuse the device can be used in a network with a prospective current of up to 100 kA.

Technical data

MS116, MS132, MS165, MO132, MO165, MS132-T

2

Type	230 V AC			400 V AC			440 V AC			500 V AC			690 V AC		
	I_{CS} kA	I_{CU} kA	gG A	I_{CS} kA	I_{CU} kA	gG A	I_{CS} kA	I_{CU} kA	gG A	I_{CS} kA	I_{CU} kA	gG A	I_{CS} kA	I_{CU} kA	gG A
MO165-16	100	100	-	100	100	-	8	8	125	8	8	125	8	8	63
MO165-20	100	100	-	100	100	-	8	8	125	8	8	125	8	8	63
MO165-25	100	100	-	100	100	-	8	8	125	8	8	125	8	8	80
MO165-32	50	100	-	50	100	-	5	5	125	5	5	125	5	5	100
MO165-42	25	50	125	25	50	125	5	5	125	5	5	125	5	5	100
MO165-54	25	50	125	25	50	125	5	5	125	5	5	125	5	5	100
MO165-65	25	50	125	25	50	125	5	5	125	5	5	125	5	5	100

Type	230 V AC			400 V AC			440 V AC			500 V AC			690 V AC		
	I_{CS} kA	I_{CU} kA	gG, aM A	I_{CS} kA	I_{CU} kA	gG, aM A	I_{CS} kA	I_{CU} kA	gG, aM A	I_{CS} kA	I_{CU} kA	gG, aM A	I_{CS} kA	I_{CU} kA	gG, aM A
MS132-0.16T	No back-up fuse required up to $I_{CC} = 100$ kA														
MS132-0.25T															
MS132-0.4T															
MS132-0.63T															
MS132-1.0T															
MS132-1.6T															
MS132-2.5T															
MS132-4.0T							30	30	35	20	20	35	3	3	32
MS132-6.3T							30	30	63	20	20	63	3	3	50
MS132-10T							30	30	100	20	20	100	3	3	50
MS132-12T							30	30	100	20	20	100	3	3	63
MS132-16T							30	30	125	20	20	125	3	3	63
MS132-20T							30	30	125	20	20	125	3	3	80
MS132-25T	50	50	125	50	50	125	30	30	125	10	10	125	3	3	100

Main circuit – Utilization characteristics according to UL/CSA

Type	MS116	MS132	MS165	MO132	MO165	MS132-T
Standards	UL 60947-1, UL 60947-4-1 (UL 508), CSA C22.2 No.60947-4-1 (CSA C22.2 No.14)					-
Rated operational voltage U_n acc. to UL/CSA	600 V AC					-
Trip class	10A	10		-		-
Motor ratings ¹⁾	Horsepower					See table "Motor ratings, three-phase"
	Full Load Amps (FLA)					See table "Motor ratings, three-phase"
	Locked Rotor Amps (LRA)					See table "Motor ratings, three-phase"

¹⁾ See product data sheets for UL/CSA single-phase motor and general use (AC-1) ratings.

UL/CSA ratings overview

Type	MS116	MS132	MS165	MO132	MO165	MS132-T
Manual Motor Controller	x	x	x	x	x	-
Manual Motor Controller, Suitable as Motor Disconnect	x	x	x	x	x	-
Manual Motor Controller, Suitable for use in Group Installations	x	x	x	x	x	-
Manual Motor Controller, Suitable for Tap Conductor Protection in Group Installations	-	x	x	x	x	-
Manual self-protected Combination Motor Controller (Type E)	-	x	x	-	-	-
Combination Motor Controller (Type F)	-	with AF contactor	with AF contactor	with AF contactor and EOL	-	-

Technical data

MS116, MS132, MS165, MO132, MO165, MS132-T

UL/CSA Motor ratings, three-phase – MS116

Type	200 V AC			208 V AC			220 ... 240 V AC			440 ... 480 V AC			550 ... 600 V AC		
	hp	FLA	LRA	hp	FLA	LRA	hp	FLA	LRA	hp	FLA	LRA	hp	FLA	LRA
MS116-0.16	-	0.16	0.96	-	0.16	0.96	-	0.16	0.96	-	0.16	0.96	-	0.16	0.96
MS116-0.25	-	0.25	1.5	-	0.25	1.5	-	0.25	1.5	-	0.25	1.5	-	0.25	1.5
MS116-0.40	-	0.4	2.4	-	0.4	2.4	-	0.4	2.4	-	0.4	2.4	-	0.4	2.4
MS116-0.63	-	0.63	3.78	-	0.63	3.78	-	0.63	3.78	-	0.63	3.78	-	0.63	3.78
MS116-1.0	-	1	6	-	1	6	-	1	6	-	1	6	1/2	1	6
MS116-1.6	-	1.6	9.6	-	1.6	9.6	-	1.6	9.6	3/4	1.6	9.6	3/4	1.6	9.6
MS116-2.5	1/2	2.5	15	1/2	2.5	15	1/2	2.5	15	1	2.5	15	1 1/2	2.5	15
MS116-4.0	3/4	4	24	3/4	4	24	1	4	24	2	4	24	3	3.9	25.6
MS116-6.3	1	6.3	37.8	1	6.3	37.8	1 1/2	6.3	37.8	3	4.8	32	5	6.1	36.8
MS116-10	2	7.8	57.5	2	7.5	55	3	9.6	64	5	7.6	46	7 1/2	9	50.8
MS116-12	3	11	73.6	3	10.6	71	3	9.6	64	7 1/2	11	63.5	10	11	64.8
MS116-16	3	11	73.6	3	10.6	71	5	15.2	92	10	14	81	10	11	64.8
MS116-20	5	17.5	105.8	5	16.7	102	5	15.2	92	10	14	81	15	17	93
MS116-25	5	17.5	105.8	7 1/2	24.2	140	7 1/2	22	127	15	21	116	20	22	116
MS116-32	7 1/2	25.3	146	10	30.8	179	10	28	162	20	27	145	25	27	146

2

UL/CSA Motor ratings, three-phase – MS132

Type	200 V AC			208 V AC			220 ... 240 V AC			440 ... 480 V AC			550 ... 600 V AC		
	hp	FLA	LRA	hp	FLA	LRA	hp	FLA	LRA	hp	FLA	LRA	hp	FLA	LRA
MS132-0.16	-	0.16	0.96	-	0.16	0.96	-	0.16	0.96	-	0.16	0.96	-	0.16	0.96
MS132-0.25	-	0.25	1.5	-	0.25	1.5	-	0.25	1.5	-	0.25	1.5	-	0.25	1.5
MS132-0.40	-	0.4	2.4	-	0.4	2.4	-	0.4	2.4	-	0.4	2.4	-	0.4	2.4
MS132-0.63	-	0.63	3.78	-	0.63	3.78	-	0.63	3.78	-	0.63	3.78	-	0.63	3.78
MS132-1.0	-	1	6	-	1	6	-	1	6	-	1	6	1/2	1	6
MS132-1.6	-	1.6	9.6	-	1.6	9.6	-	1.6	9.6	3/4	1.6	9.6	3/4	1.6	9.6
MS132-2.5	1/2	2.5	15	1/2	2.5	15	1/2	2.5	15	1	2.5	15	1-1/2	2.5	15
MS132-4.0	3/4	4	24	3/4	4	24	1	4	24	2	4	24	3	3.9	25.6
MS132-6.3	1	6.3	37.8	1	6.3	37.8	1 1/2	6.3	37.8	3	4.8	32	5	6.1	36.8
MS132-10	2	7.8	57.5	2	7.5	55	3	9.6	64	5	7.6	46	7 1/2	9	50.8
MS132-12	3	11	73.6	3	10.6	71	3	9.6	64	7 1/2	11	63.5	10	11	64.8
MS132-16	3	11	73.6	3	10.6	71	5	15.2	92	10	14	81	10	11	64.8
MS132-20	5	17.5	105.8	5	16.7	102	5	15.2	92	10	14	81	15	17	93
MS132-25	5	17.5	105.8	7 1/2	24.2	140	7 1/2	22	127	15	21	116	20	22	116
MS132-32	7 1/2	25.3	146	10	30.8	179	10	28	162	20	27	145	25	27	146

UL/CSA Motor ratings, three-phase – MS165

Type	200 V AC			208 V AC			220 ... 240 V AC			440 ... 480 V AC			550 ... 600 V AC		
	hp	FLA	LRA	hp	FLA	LRA	hp	FLA	LRA	hp	FLA	LRA	hp	FLA	LRA
MS165-16	3	11	73.6	3	10.6	71	5	15.2	92	10	14	81	10	11	64.8
MS165-20	5	17.5	105.8	5	16.7	102	5	15.2	92	10	14	81	15	17	93
MS165-25	5	17.5	105.8	7 1/2	24.2	140	7 1/2	22	127	15	21	116	20	22	116
MS165-32	7 1/2	25.3	146	10	30.8	179	10	28	162	20	27	145	30	32	174
MS165-42	10	32.2	186.3	10	30.8	179	15	42	232	30	40	218	40	41	232
MS165-54	15	48.3	267	15	46.2	257	20	54	290	40	52	290	50	52	290
MS165-65	20	62.1	334	20	59.4	321	20	54	290	50	65	363	60	62	348

hp Horsepower
 FLA Full Load Amps
 LRA Locked Rotor Amps

Note: Manual motor starters should always be selected so that the actual motor current is within the setting range; see ordering detail pages. Horsepower (hp) ratings are for reference only.

Technical data

MS116, MS132, MS165, MO132, MO165, MS132-T

UL/CSA Motor ratings, three-phase – MO132

Type	200 V AC			208 V AC			220 ... 240 V AC			440 ... 480 V AC			550 ... 600 V AC		
	hp	FLA	LRA	hp	FLA	LRA	hp	FLA	LRA	hp	FLA	LRA	hp	FLA	LRA
MO132-0.16	-	0.16	0.96	-	0.16	0.96	-	0.16	0.96	-	0.16	0.96	-	0.16	0.96
MO132-0.25	-	0.25	1.5	-	0.25	1.5	-	0.25	1.5	-	0.25	1.5	-	0.25	1.5
MO132-0.40	-	0.4	2.4	-	0.4	2.4	-	0.4	2.4	-	0.4	2.4	-	0.4	2.4
MO132-0.63	-	0.63	3.78	-	0.63	3.78	-	0.63	3.78	-	0.63	3.78	-	0.63	3.78
MO132-1.0	-	1	6	-	1	6	-	1	6	-	1	6	1/2	1	6
MO132-1.6	-	1.6	9.6	-	1.6	9.6	-	1.6	9.6	3/4	1.6	9.6	3/4	1.6	9.6
MO132-2.5	1/2	2.5	15	1/2	2.5	15	1/2	2.5	15	1	2.5	15	1 1/2	2.5	15
MO132-4.0	3/4	4	24	3/4	4	24	1	4	24	2	4	24	3	3.9	25.6
MO132-6.3	1	6.3	37.8	1	6.3	37.8	1 1/2	6.3	37.8	3	4.8	32	5	6.1	36.8
MO132-10	2	7.8	57.5	2	7.5	55	3	9.6	64	5	7.6	46	7 1/2	9	50.8
MO132-12	3	11	73.6	3	10.6	71	3	9.6	64	7 1/2	11	63.5	10	11	64.8
MO132-16	3	11	73.6	3	10.6	71	5	15.2	92	10	14	81	10	11	64.8
MO132-20	5	17.5	105.8	5	16.7	102	5	15.2	92	10	14	81	15	17	93
MO132-25	5	17.5	105.8	7 1/2	24.2	140	7 1/2	22	127	15	21	116	20	22	116
MO132-32	7 1/2	25.3	146	10	30.8	179	10	28	162	20	27	145	25	27	146

UL/CSA Motor ratings, three-phase – MO165

Type	200 V AC			208 V AC			220 ... 240 V AC			440 ... 480 V AC			550 ... 600 V AC		
	hp	FLA	LRA	hp	FLA	LRA	hp	FLA	LRA	hp	FLA	LRA	hp	FLA	LRA
MO165-16	3	11	73.6	3	10.6	71	5	15.2	92	10	14	81	10	11	64.8
MO165-20	5	17.5	105.8	5	16.7	102	5	15.2	92	10	14	81	15	17	93
MO165-25	5	17.5	105.8	7 1/2	24.2	140	7 1/2	22	127	15	21	116	20	22	116
MO165-32	7 1/2	25.3	146	10	30.8	179	10	28	162	20	27	145	30	32	174
MO165-42	10	32.2	186.3	10	30.8	179	15	42	232	30	40	218	40	41	232
MO165-54	15	48.3	267	15	46.2	257	20	54	290	40	52	290	50	52	290
MO165-65	20	62.1	334	20	59.4	321	20	54	290	50	65	363	60	62	348

hp Horsepower
 FLA Full Load Amps
 LRA Locked Rotor Amps

Technical data

MS116, MS132, MS165, MO132, MO165, MS132-T

UL/CSA Maximum short-circuit current ratings – MS116

Type	Manual Motor Controllers					
	Branch circuit protection, max. size per NEC/CEC ¹⁾		for motor disconnect ²⁾		for group installations	
	Fuses	Circuit breaker	480 V	600 V	480 V	600 V
A	A	kA	kA	kA	kA	
MS116-0.16	100	-	30	5	30	5
MS116-0.25	100	-	30	5	30	5
MS116-0.40	100	-	30	5	30	5
MS116-0.63	100	-	30	5	30	5
MS116-1.0	100	-	30	5	30	5
MS116-1.6	100	-	30	5	30	5
MS116-2.5	100	-	30	5	30	5
MS116-4.0	100	-	18	5	18	5
MS116-6.3	100	-	18	5	18	5
MS116-10	100	-	18	5	18	5
MS116-12	100	-	18	5	18	5
MS116-16	100	-	18	5	18	5
MS116-20	100	-	18	5	18	5
MS116-25	100	-	18	5	18	5
MS116-32	100	-	18	5	18	5

¹⁾ NEC: NFPA@70 National Electrical Code®; CEC: CSA C22.1 Canadian Electrical Code.

²⁾ Suitable as motor disconnect only when provide with padlock adaptor SA1 or SA3.

UL/CSA Maximum short-circuit current ratings – MS132

Type	Manual Motor Controllers						Manual self-protected Combination Motor Controllers (Type E) ²⁾			
	Branch circuit protection, max. size per NEC/CEC ¹⁾		for motor disconnect		for group installations		for tap conductor protection in group installations		480Y / 277 V	600Y / 374 V
	Fuses	Circuit breaker	480 V	600 V	480 V	600 V	480 V	600 V	kA	kA
A	A	kA	kA	kA	kA	kA	kA	kA	kA	
MS132-0.16	Any Listed	Any Listed	65	47	65	47	65	47	65	47
MS132-0.25	fuses. Size	UL489 /	65	47	65	47	65	47	65	47
MS132-0.40	per NEC/CEC	CSA C22.2	65	47	65	47	65	47	65	47
MS132-0.63		No.5 circuit	65	47	65	47	65	47	65	47
MS132-1.0		breaker.	65	47	65	47	65	47	65	47
MS132-1.6		Size per	65	47	65	47	65	47	65	47
MS132-2.5		NEC/CEC	65	47	65	47	65	47	65	47
MS132-4.0			65	47	65	47	65	47	65	47
MS132-6.3			65	18	65	35	65	18	65	18
MS132-10			65	18	65	35	65	18	65	18
MS132-12			30	18	35	35	30	18	30	-
MS132-16			30	18	35	35	30	18	30	-
MS132-20			30	18	35	35	30	18	30	-
MS132-25			30	18	35	35	30	18	30	-
MS132-32			30	18	35	35	30	18	30	-

¹⁾ NEC: NFPA@70 National Electrical Code®; CEC: CSA C22.1 Canadian Electrical Code.

²⁾ Requires the use of S1-M3-xx line-side terminal feeder block.

Technical data

MS116, MS132, MS165, MO132, MO165, MS132-T

UL/CSA Maximum short-circuit current ratings – MS132 with AF contactors

Type	Combination Motor Controllers (Type F) ¹⁾		
	Minimum contactor size	480Y / 277 V	600Y / 374 V
		kA	kA
MS132-0.16	AF26 ... AF38	65	47
MS132-0.25	AF26 ... AF38	65	47
MS132-0.40	AF26 ... AF38	65	47
MS132-0.63	AF26 ... AF38	65	47
MS132-1.0	AF26 ... AF38	65	47
MS132-1.6	AF26 ... AF38	65	47
MS132-2.5	AF26 ... AF38	65	47
MS132-4.0	AF26 ... AF38	65	47
MS132-6.3	AF26 ... AF38	65	47
MS132-10	AF26 ... AF38	65	47
MS132-12	AF26 ... AF38	30	-
MS132-16	AF26 ... AF38	30	-
MS132-20	AF26 ... AF38	30	-
MS132-25	AF26 ... AF38	30	-
MS132-32	AF26 ... AF38	30	-

¹⁾ Requires the use of S1-M3-xx line-side terminal feeder block.

UL/CSA Maximum short-circuit current ratings – MS165

Type	Manual Motor Controllers						Manual self-protected Combination Motor Controllers (Type E)			
	Branch circuit protection, max. size per NEC/CEC ¹⁾		for motor disconnect		for group installations		for tap conductor protection in group installations		480Y / 277 V	600Y / 374 V
	Fuses	Circuit breaker	480 V	600 V	480 V	600 V	480 V	600 V	kA	kA
	A	A	kA	kA	kA	kA	kA	kA	kA	kA
MS165-16	Any Listed fuses. Size per NEC/CEC	Any Listed UL489 / CSA C22.2 No.5 circuit breaker. Size per NEC/CEC	65	30	65	30	65	30	65	30
MS165-20			65	30	65	30	65	30	65	30
MS165-25			65	30	65	30	65	30	65	30
MS165-32			65	30	65	30	65	30	65	30
MS165-42			65	30	65	30	65	30	65	-
MS165-54			65	30	65	30	65	30	65	-
MS165-65			65	30	65	30	65	30	65	-

¹⁾ NEC: NFPA@70 National Electrical Code®; CEC: CSA C22.1 Canadian Electrical Code.

UL/CSA Maximum short-circuit current ratings – MS165 with AF contactors

Type	Combination Motor Controllers (Type F)		
	Minimum contactor size	480Y / 277 V	600Y / 374 V
		kA	kA
MS165-16	AF09	65	30
MS165-20	AF26	65	30
MS165-25	AF26	65	30
MS165-32	AF26	65	30
MS165-42	AF40	65	-
MS165-54	AF40	65	-
MS165-65	AF40	65	-

Technical data

MS116, MS132, MS165, MO132, MO165, MS132-T

UL/CSA Maximum short-circuit current ratings – MO132

Type	Manual Motor Controllers		for motor disconnect		for group installations		for tap conductor protection in group installations	
	Branch circuit protection, max. size per NEC/CEC ¹⁾		480 V	600 V	480 V	600 V	480 V	600 V
	Fuses	Circuit breaker	kA	kA	kA	kA	kA	kA
MO132-0.16	Any Listed fuses. Size per NEC/ CEC	Any Listed UL489 / CSA C22.2 No.5 circuit breaker. Size per NEC/ CEC	65	47	65	47	65	47
MO132-0.25			65	47	65	47	65	47
MO132-0.40			65	47	65	47	65	47
MO132-0.63			65	47	65	47	65	47
MO132-1.0			65	47	65	47	65	47
MO132-1.6			65	47	65	47	65	47
MO132-2.5			65	47	65	47	65	47
MO132-4.0			65	47	65	47	65	47
MO132-6.3			65	18	65	35	65	18
MO132-10			65	18	65	35	65	18
MO132-12			30	18	35	35	30	18
MO132-16			30	18	35	35	30	18
MO132-20			30	18	35	35	30	18
MO132-25			30	18	35	35	30	18
MO132-32	30	18	35	35	30	18		

¹⁾ NEC: NFPA@70 National Electrical Code®; CEC: CSA C22.1 Canadian Electrical Code.

UL/CSA Maximum short-circuit current ratings – MO165

Type	Manual Motor Controllers		for motor disconnect		for group installations		for tap conductor protection in group installations	
	Branch circuit protection, max. size per NEC/CEC ¹⁾		480 V	600 V	480 V	600 V	480 V	600 V
	Fuses	Circuit breaker	kA	kA	kA	kA	kA	kA
MO165-16	Any Listed fuses. Size per NEC/ CEC	Any Listed UL489 / CSA C22.2 No.5 circuit breaker. Size per NEC/ CEC	65	30	65	30	65	30
MO165-20			65	30	65	30	65	30
MO165-25			65	30	65	30	65	30
MO165-32			65	30	65	30	65	30
MO165-42			65	30	65	30	65	30
MO165-54			65	30	65	30	65	30
MO165-65			65	30	65	30	65	30

¹⁾ NEC: NFPA@70 National Electrical Code®; CEC: CSA C22.1 Canadian Electrical Code.

Technical data





MS116, MS132, MS165, MO132, MO165, MS132-T

General technical data





Type	MS116	MS132	MS165	MO132	MO165	MS132-T
Pollution degree	3	3	3	3	3	3
Phase loss sensitivity	Yes	Yes	Yes	No	No	Yes
Disconnect function acc. to IEC/EN 60947-2	Yes	Yes	Yes	Yes	Yes	Yes
Ambient air temperature						
Operation						
Open - compensated	-25 ... +55 °C	-25 ... +60 °C	-25 ... +60 °C	-	-	-25 ... +60 °C
Open	-25 ... +70 °C	-25 ... +70 °C	-25 ... +60 °C	-25 ... +60 °C	-25 ... +60 °C	-25 ... +70 °C
Enclosed (IB132)	0 ... +40 °C	0 ... +40 °C	-	-	-	0 ... +40 °C
Storage	-50 ... +80 °C	-50 ... +80 °C	-50 ... +80 °C	-50 ... +80 °C	-50 ... +80 °C	-50 ... +80 °C
Ambient air temperature compensation	Acc. to IEC/EN60947-4-1	Acc. to IEC/EN60947-4-1	Acc. to IEC/EN60947-4-1	-	-	Acc. to IEC/EN60947-4-1
Maximum operating altitude permissible	2000 m	2000 m	2000 m	2000 m	2000 m	2000 m
Resistance to shock acc. to IEC 60068-2-27	25g / 11 ms	25g / 11 ms	25g / 11 ms	25g / 11 ms	25g / 11 ms	25g / 11 ms
Resistance to vibrations acc. to IEC 60068-2-6	5g / 3 ... 150 Hz	5g / 3 ... 150 Hz	5g / 3 ... 150 Hz	5g / 3 ... 150 Hz	5g / 3 ... 150 Hz	5g / 3 ... 150 Hz
Mounting position	Position 1-6 (optional for single mounting)	Position 1-6 (optional for single mounting)	Position 1-6 (optional for single mounting)	Position 1-6 (optional for single mounting)	Position 1-6 (optional for single mounting)	Position 1-6 (optional for single mounting)
Mounting	DIN-rail (EN 60715)	DIN-rail (EN 60715)	DIN-rail (EN 60715)	DIN-rail (EN 60715)	DIN-rail (EN 60715)	DIN-rail (EN 60715)
Group mounting	On request	On request	On request	On request	On request	-
Minimum distance to other units same type	Horizontal Vertical	0 mm 150 mm	0 mm 150 mm	0 mm 150 mm	0 mm 150 mm	0 mm 150 mm
Minimum distance to electrical conductive board	Horizontal, up to 400 V Horizontal, up to 690 V Vertical	0 mm > 1.5 mm 75 mm	0 mm > 1.5 mm 75 mm	0 mm > 1.5 mm 75 mm	0 mm > 1.5 mm 75 mm	0 mm > 1.5 mm 75 mm
Degree of protection	Housing Main circuit terminals	IP20 IP20	IP20 IP20	IP20 IP20	IP20 IP10	IP20 IP20

Connecting characteristics

Main circuit

Type	MS116 ≤ 16 A	MS116 ≥ 20 A
Connecting capacity		
 Rigid	1 or 2 x 1 ... 4 mm ²	2.5 ... 6 mm ²
 Flexible with ferrule	1 or 2 x 0.75 ... 2.5 mm ²	1 ... 6 mm ²
 Flexible with insulated ferrule	1 or 2 x 0.75 ... 2.5 mm ²	1 ... 6 mm ²
 Flexible	1 or 2 x 0.75 ... 2.5 mm ²	1 ... 6 mm ²
Stranded acc. to UL/CSA	1 or 2 x AWG 16-12	AWG 16-8
Stripping length	9 mm	10 mm
Tightening torque	0.8 ... 1.2 Nm / 10 ... 12 lb.in	2.0 Nm / 18 lb.in
Recommended screw driver	Pozidriv 2	Pozidriv 2





Main circuit

Type	MS132 ≤ 10 A	MS132 ≥ 12 A
Connecting capacity		
 Rigid	1 or 2 x 1 ... 4 mm ²	1 ... 2.5 mm ² 2.5 ... 6 mm ²
 Flexible with ferrule	1 or 2 x 0.75 ... 2.5 mm ²	0.75 ... 6 mm ²
 Flexible with insulated ferrule	1 or 2 x 0.75 ... 2.5 mm ²	0.75 ... 6 mm ²
 Flexible	1 or 2 x 0.75 ... 2.5 mm ²	1 ... 2.5 mm ² 2.5 ... 6 mm ²
Stranded acc. to UL/CSA	1 or 2 x AWG 16-12	AWG 16-8
Stripping length	9 mm	10 mm
Tightening torque	0.8 ... 1.2 Nm / 10 ... 12 lb.in	2.0 Nm / 18 lb.in
Recommended screw driver	Pozidriv 2	Pozidriv 2





Technical data





MS116, MS132, MS165, MO132, MO165, MS132-T





Connecting characteristics

Main circuit		MS165	
Type			
Connecting capacity			
 Rigid	1 or 2 x	1 ... 50 mm ²	
 Flexible with ferrule	1 or 2 x	1 ... 35 mm ²	
 Flexible with insulated ferrule	1 or 2 x	1 ... 35 mm ²	
 Flexible	1 or 2 x	1 ... 35 mm ²	
Stranded acc. to UL/CSA		1 or 2 x	AWG 16-3
Stripping length	16 mm		
Tightening torque	4.0 Nm / 35 lb.in		
Recommended screw driver	Pozidriv 2		

2

Main circuit		MO132 ≤ 10 A		MO132 ≥ 12 A	
Type					
Connecting capacity					
 Rigid	1 or 2 x	1 ... 4 mm ²		1 ... 2.5 mm ²	2.5 ... 6 mm ²
 Flexible with ferrule	1 or 2 x	0.75 ... 2.5 mm ²		0.75 ... 6 mm ²	
 Flexible with insulated ferrule	1 or 2 x	0.75 ... 2.5 mm ²		0.75 ... 6 mm ²	
 Flexible	1 or 2 x	0.75 ... 2.5 mm ²		1 ... 2.5 mm ²	2.5 ... 6 mm ²
Stranded acc. to UL/CSA		1 or 2 x	AWG 16-12	AWG 16-8	
Stripping length	9 mm		10 mm		
Tightening torque	0.8 ... 1.2 Nm / 10 ... 12 lb.in			2.0 Nm / 18 lb.in	
Recommended screw driver	Pozidriv 2		Pozidriv 2		

Main circuit		MO165	
Type			
Connecting capacity			
 Rigid	1 or 2 x	1 ... 50 mm ²	
 Flexible with ferrule	1 or 2 x	1 ... 35 mm ²	
 Flexible with insulated ferrule	1 or 2 x	1 ... 35 mm ²	
 Flexible	1 or 2 x	1 ... 35 mm ²	
Stranded acc. to UL/CSA		1 or 2 x	AWG 16-3
Stripping length	16 mm		
Tightening torque	4.0 Nm / 35 lb.in		
Recommended screw driver	Pozidriv 2		

Main circuit		MS132-T ≤ 10 A		MS132-T ≥ 12 A	
Type					
Connecting capacity					
 Rigid	1 or 2 x	1 ... 4 mm ²		1/2 x 1 ... 2.5 mm ²	1/2 x 2.5 ... 6 mm ²
 Flexible with ferrule	1 or 2 x	0.75 ... 2.5 mm ²		1/2 x 0.75 ... 6 mm ²	
 Flexible with insulated ferrule	1 or 2 x	0.75 ... 2.5 mm ²		1/2 x 0.75 ... 6 mm ²	
 Flexible	1 or 2 x	0.75 ... 2.5 mm ²		1/2 x 1 ... 2.5 mm ²	1/2 x 2.5 ... 6 mm ²
Stripping length	9 mm		10 mm		
Tightening torque	0.8 ... 1.2 Nm / 10 ... 12 lb.in			2.0 Nm / 18 lb.in	
Recommended screw driver	Pozidriv 2		Pozidriv 2		

2CDC131062C0201

Main accessories

MS116, MS132, MS165, MO132, MO165, MS132-T

Manual motor starters with accessories (MS116, MO132, MO165)

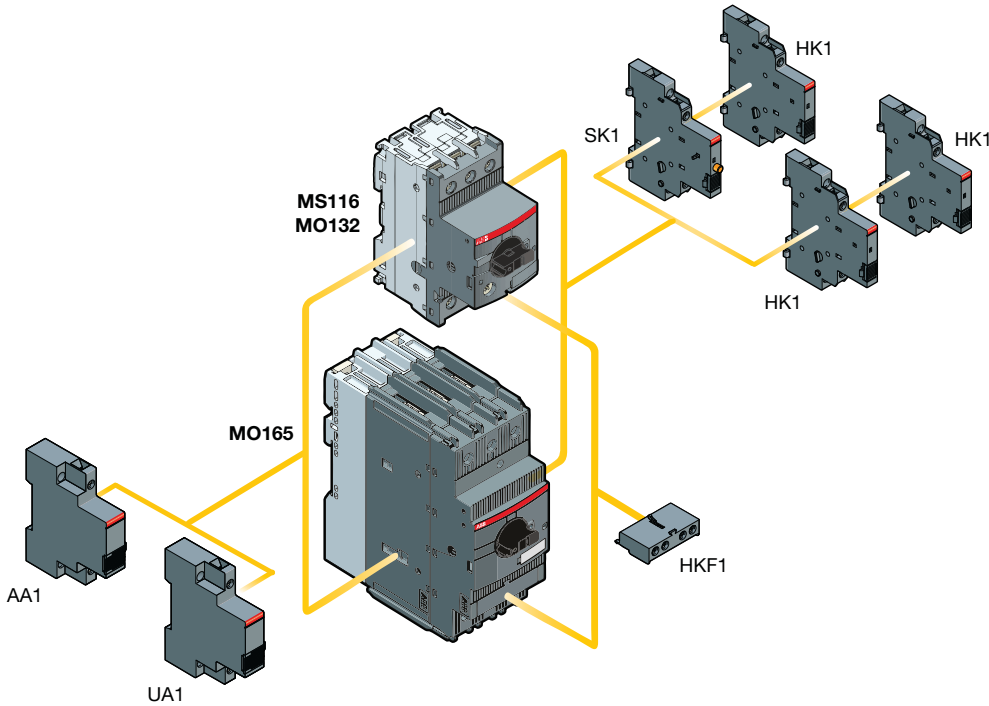

Manual motor starters with accessories (MS132, MS165) and circuit breaker for transformer protection (MS132-T)

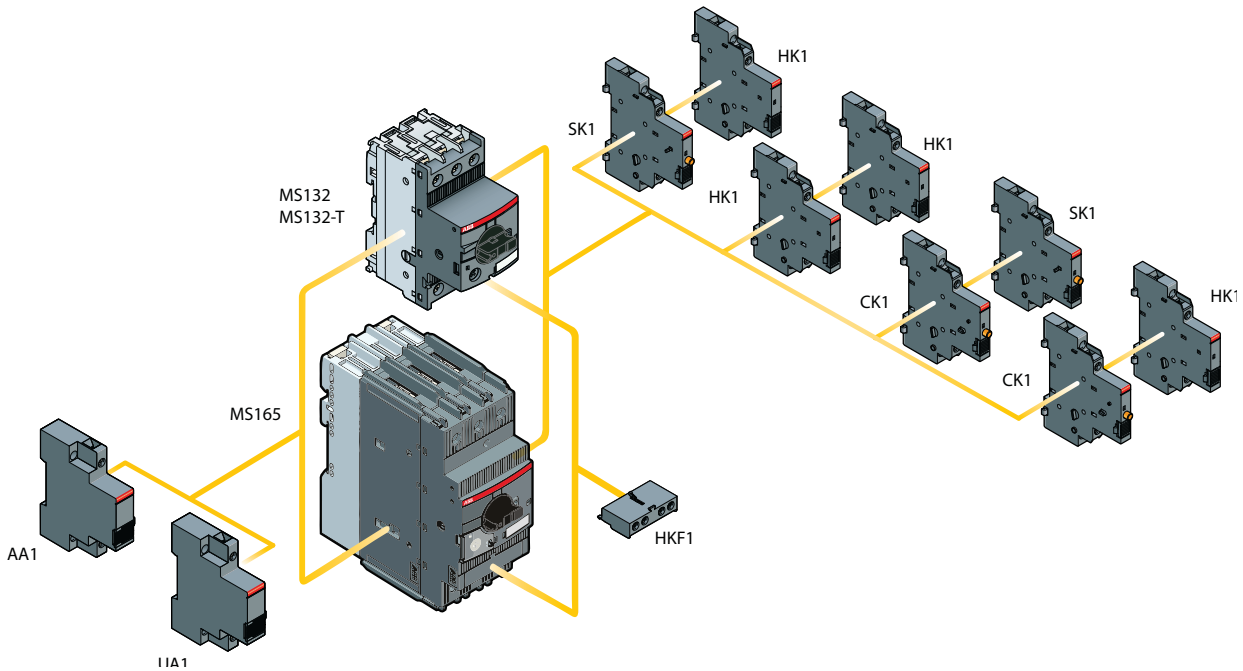

Main accessories

MS116, MS132, MS165, MO132, MO165, MS132-T



HKF1-11

1SBC101208F0014



HK1-11

1SBC101208F0014



SK1-11

1SBC101210F0014



CK1-11

1SBC101288F0014

Description

MMS and MS132-T can be equipped with auxiliary contacts for lateral/front mounting, signaling contacts for lateral mounting, undervoltage releases and shunt trips. Two different signaling contacts are available. The accessories can be fitted wiring free and without tools. A variety of combinations is possible as required for the application. The auxiliary contacts change position with the main contacts. The signaling contact SK signals tripping regardless if it was caused by short-circuit or overload. The signaling contact CK signals tripping in case it was caused by short-circuit. Undervoltage releases are used for remote tripping of the manual motor starters especially for emergency stop circuits. Shunt trips release the MMS used for remote tripping. These main accessories are suitable throughout the MS116/MS132/MS165-range.

Ordering details

Suitable for	Auxiliary contacts N.O.	Auxiliary contacts N.C.	Description	Type	Order code	Pkg qty	Weight (1 pc)
						pcs	kg
Auxiliary contacts – mountable on the front							
MS116,	1	1		HKF1-11	1SAM201901R1001	10	0.015
MS132, MS165	1	0		HKF1-10	1SAM201901R1003	10	0.013
MO132, MO165	0	1		HKF1-01	1SAM201901R1004	10	0.013
MS132-T	2	0		HKF1-20	1SAM201901R1002	10	0.015
Auxiliary contacts – mountable on the right							
MS116,	1	1	max. 2 pieces	HK1-11	1SAM201902R1001	2	0.035
MS132, MS165	2	0	max. 2 pieces	HK1-20	1SAM201902R1002	2	0.035
MO132, MO165	0	2	max. 2 pieces	HK1-02	1SAM201902R1003	2	0.035
MS132-T	2	0	with lead contacts	HK1-20L	1SAM201902R1004	2	0.035
Signaling contacts – mountable on the right							
MS116,	1	1	for tripped alarm, max. 2 pieces	SK1-11	1SAM201903R1001	2	0.035
MS132, MS165	2	0	for tripped alarm, max. 2 pieces	SK1-20	1SAM201903R1002	2	0.035
MO132, MO165	0	2	for tripped alarm, max. 2 pieces	SK1-02	1SAM201903R1003	2	0.035
MS132-T	2	0	for tripped alarm, max. 2 pieces	SK1-20L	1SAM201903R1004	2	0.035
MS132, MS165,	1	1	for short-circuit alarm, max. 2 pieces	CK1-11	1SAM301901R1001	2	0.035
MS132-T	2	0	for short-circuit alarm, max. 2 pieces	CK1-20	1SAM301901R1002	2	0.035
	0	2	for short-circuit alarm, max. 2 pieces	CK1-02	1SAM301901R1003	2	0.035

Main dimensions mm, inches

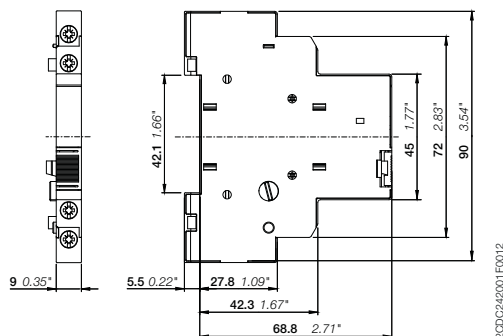

HK1

2CDC242001F0012

Main accessories

MS116, MS132, MS165, MO132, MO165, MS132-T

2



1SBC101211F0014

AA1-24



1SBC101212F0014

UA1-24

Ordering details

Suitable for	Rated control supply voltage		Type	Order code	Pkg qty	Weight (1 pc)
	50 Hz V AC	60 Hz V AC				
					pcs	kg
Shunt trips – mountable on the left						
MS116, MS132, MS165, MO132, MO165, MS132-T	20 ... 24	20 ... 24	AA1-24	1SAM201910R1001	1	0.100
	110	110	AA1-110	1SAM201910R1002	1	0.100
	200 ... 240	200 ... 240	AA1-230	1SAM201910R1003	1	0.100
	350 ... 415	350 ... 415	AA1-400	1SAM201910R1004	1	0.100
Undervoltage releases – mountable on the left						
MS116, MS132, MS165, MO132, MO165, MS132-T	20	24	UA1-20	1SAM201904R1010	1	0.100
	24	-	UA1-24	1SAM201904R1001	1	0.100
	48	-	UA1-48	1SAM201904R1002	1	0.100
	60	-	UA1-60	1SAM201904R1003	1	0.100
	110	120	UA1-110	1SAM201904R1004	1	0.100
	-	208	UA1-208	1SAM201904R1008	1	0.100
	230	240	UA1-230	1SAM201904R1005	1	0.100
	400	-	UA1-400	1SAM201904R1006	1	0.100
	415	480	UA1-415	1SAM201904R1007	1	0.100
	-	575	UA1-575	1SAM201904R1009	1	0.100

Main dimensions mm, inches

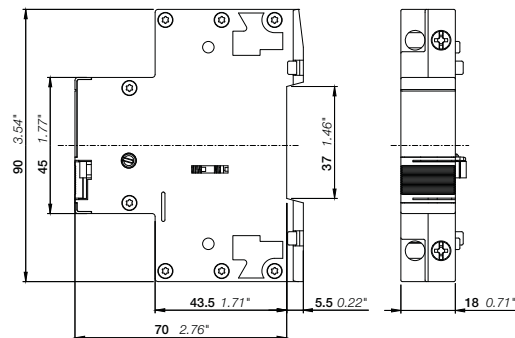

AA1, UA1

2DCDC242002F0012

2CDC131050C0201

Main accessories

MS116, MS132, MS165, MO132, MO165, MS132-T

General technical data





Type	HK1, SK1, CK1	HKF1
Standards	IEC/EN 60947-2, IEC/EN 60947-4-1, IEC/EN 60947-1	
Rated operational voltage U_n	690 V AC / 600 DC	250 V AC / 250 V DC
Conventional free-air thermal current I_{th}	6 A	5 A
Rated frequency	50/60 Hz	
Rated impulse withstand voltage U_{imp}	6 kV	
Rated insulation voltage U_i	690 V AC	250 V AC
Pollution degree	3	
Ambient air temperature	Operation	-25 ... +70 °C
	Storage	-50 ... +80 °C
Resistance to shock acc. to IEC 60068-2-27	25g / 11 ms	
Resistance to vibrations acc. to IEC 60068-2-6	5g / 3 ... 150 Hz	
I_n / Rated operational current AC-15 acc. to IEC/EN 60947-5-1 for utilization category		
	24 V, 120 V	6 A
	240 V	4 A
	400 V	3 A
	440 V, 690 V	1 A
		3 A
		1.5 A
		-
		-
I_n / Rated operational current DC-13 acc. to IEC/EN 60947-5-1 for utilization category		
	24 V	2 A
	125 V	0.55 A
	250 V	0.27 A
	440 V, 600 V	0.15 A
		1 A
		0.27 A
		0.11 A
		-
Minimum switching capacity	17 V / 5 mA	
Short-circuit protective device	N.C., 95-96	10 A Type gG
	N.O., 97-98	10 A Type gG
Duty time	100 %	
Mounting	Right side of MMS / MS132-T	Front of MMS / MS132-T
Mounting positions	1-6	
Mechanical durability	50000 cycles	
Electrical durability	50000 cycles	

Contact utilization characteristics according to UL/CSA

Type	HK1, SK1, CK1	HKF1
Standards	UL 60947-1, UL 60947-4-1 (UL 508), CSA C22.2 No.60947-4-1 (CSA C22.2 No.14)	
Rated operational voltage U_n acc. to UL/CSA	600 V AC / 600 V DC	250 V AC / 250 V DC
Pilot duty	A600, Q600	B300, Q300
AC thermal rated current	10 A	5 A
AC maximum volt-ampere making	7200 VA	3600 VA
AC maximum volt-ampere breaking	720 VA	360 VA
DC thermal rated current	2.5 A	2.5 A
DC maximum volt-ampere making-breaking	69 VA	69 VA

Connecting characteristics

Auxiliary circuit

Type	HK1, SK1, CK1	HKF1
Connecting capacity		
 Rigid	1 or 2 x	1 ... 1.5 mm ²
 Flexible with ferrule	1 or 2 x	0.75 ... 1.5 mm ²
 Flexible with insulated ferrule	1 or 2 x	0.75 ... 1.5 mm ²
 Flexible	1 or 2 x	0.75 ... 1.5 mm ²
Stranded acc. to UL/CSA	1 or 2 x	AWG 16-14
Stripping length	8 mm	
Tightening torque	0.8 ... 1.2 Nm / 7 lb.in	
Recommended screw driver	Pozidriv 2	

Main accessories





MS116, MS132, MS165, MO132, MO165, MS132-T

General technical data

Type	UA1	AA1
Standards	IEC/EN 60947-1, IEC/EN 60947-4-1, UL 60947-1, UL 60947-4-1 (UL 508), CSA C22.2 No.60947-4-1 (CSA C22.2 No.14)	
Rated control supply voltage	see ordering details	AA1-24: 20-24 V 50/60 Hz; 20-70 V 50/60 Hz KB = 5 s, 20-70 V DC KB = 5 s AA1-100: 110 V 50/60 Hz; 110-200 V 50/60 Hz KB = 5 s, 110-200 V DC KB = 5 s AA1-230: 200-240 V 50/60 Hz, 200-350 V 50/60 Hz KB = 5 s, 200-350 V DC KB = 5 s AA1-400: 350-415 V 50/60 Hz, 350-500 V 50/60 Hz KB = 5 s, 350-500 V DC KB = 5 s
Rated frequency	see ordering details	50/60 Hz, DC
Operating voltage	Tripping 0.35 ... 0.7 x U _s Coil operating voltage 0.85 ... 1.1 x U _s	0.7 ... 1.1 x U _s -
Power consumption	Pull-in AC on request DC on request Holding AC on request DC on request	on request on request - - -
Rated impulse withstand voltage U _{imp}	6 kV	6 kV
Rated insulation voltage U _i	690 V	690 V
Pollution degree	3	3
Ambient air temperature	Operation -25 ... +60 °C Storage -50 ... +80 °C	-25 ... +60 °C -50 ... +80 °C
Resistance to shock acc. to IEC 60068-2-27	25g / 11 ms	25g / 11 ms
Resistance to vibrations acc. to IEC 60068-2-6	5g / 3 ... 150 Hz	5g / 3 ... 150 Hz
Mounting	left side of MMS / MS132-T	left side of MMS / MS132-T
Mounting positions	-	-

Connecting characteristics

Auxiliary circuit

Type	UA1	AA1
Connecting capacity		
 Rigid	1 or 2 x 1 ... 4 mm ²	
 Flexible with ferrule	1 or 2 x 0.75 ... 2.5 mm ²	
 Flexible with insulated ferrule	1 x 0.75 ... 2.5 mm ² 2 x 0.75 ... 1.5 mm ²	
 Flexible	1 or 2 x 0.75 ... 2.5 mm ²	
Stranded acc. to UL/CSA	1 or 2 x AWG 16-12	
Stripping length	10 mm	
Tightening torque	0.8 ... 1.2 Nm / 7 lb.in	
Recommended screw driver	Pozidriv 2	

Main accessories

MS116, MS132, MS165, MO132, MO165

Manual motor starter with three-phase busbar systems (MS116, MS132, MO132)

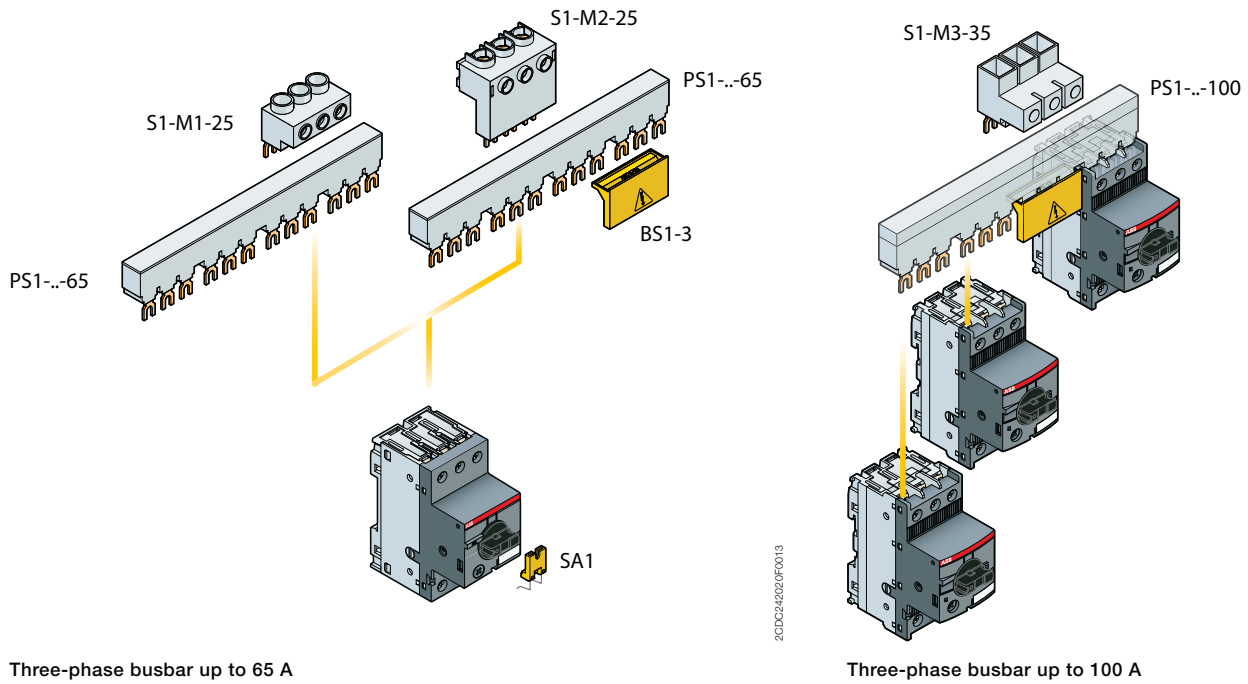

Manual motor starter with three-phase busbar systems (MS165, MO165)

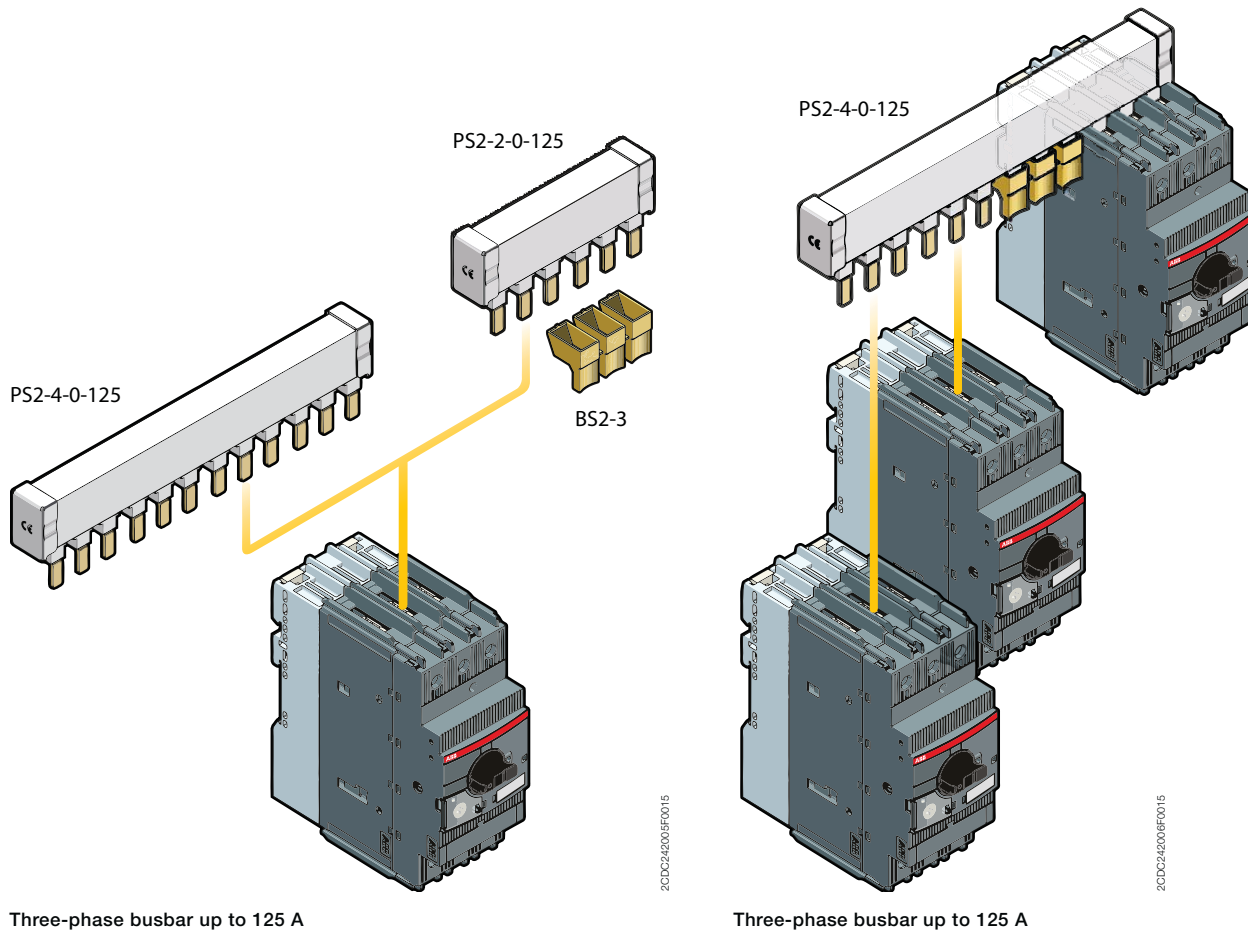

Main accessories

MS116, MS132, MO132, MS132-T

2

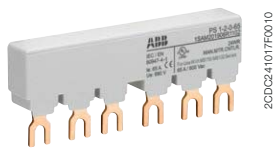

PS1-2-0-65

2CDC241017F0010

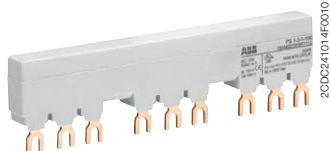

PS1-3-1-100

2CDC241014F0010

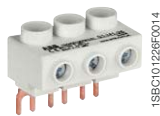

S1-M1-25

1SBC101226F0014



S1-M2-25

1SBC101266F0014



SA2

2CDC241023F0013



SA1

SK0108B91



PB1-1-32

2CDC241004R0014



S1-PB1-25

2CDC241005S0014

Description

Three-phase busbars ensure a quick and safe connection and are therefore a cost effective solution. A variety of different three-phase busbars up to 100 A are in the assortment. Between 2 and 5 manual motor starters with none, one or two lateral auxiliary contacts can be connected. Different three-phase feeder terminals are available according to the application.

Phase connecting links and phase power infeed blocks are also available for single-phase applications.

Ordering details

Suitable for	Rated operational current	Number of MMS	Number of lateral aux.	Type	Order code	Pkg qty	Weight (1 pc)
	A					pcs	kg
Three-phase busbars							
MS116, MS132, MO132	65	2	0	PS1-2-0-65	1SAM201906R1102	10	0.034
	65	3	0	PS1-3-0-65	1SAM201906R1103	10	0.055
	65	4	0	PS1-4-0-65	1SAM201906R1104	10	0.077
	65	5	0	PS1-5-0-65	1SAM201906R1105	10	0.098
	65	2	1	PS1-2-1-65	1SAM201906R1112	10	0.036
	65	3	1	PS1-3-1-65	1SAM201906R1113	10	0.060
	65	4	1	PS1-4-1-65	1SAM201906R1114	10	0.087
	65	5	1	PS1-5-1-65	1SAM201906R1115	10	0.108
	65	2	2	PS1-2-2-65	1SAM201906R1122	10	0.040
	65	3	2	PS1-3-2-65	1SAM201906R1123	10	0.067
	65	4	2	PS1-4-2-65	1SAM201906R1124	10	0.095
	65	5	2	PS1-5-2-65	1SAM201906R1125	10	0.122
MS116, MS132, MO132	100	3	0	PS1-3-0-100	1SAM201916R1103	10	0.084
	100	4	0	PS1-4-0-100	1SAM201916R1104	10	0.117
	100	5	0	PS1-5-0-100	1SAM201916R1105	10	0.154
	100	3	1	PS1-3-1-100	1SAM201916R1113	10	0.094
	100	4	1	PS1-4-1-100	1SAM201916R1114	10	0.134
	100	5	1	PS1-5-1-100	1SAM201916R1115	10	0.172
	100	3	2	PS1-3-2-100	1SAM201916R1123	10	0.105

Suitable for	Rated operational current	Rated cross section	Mounting form	Type	Order code	Pkg qty	Weight (1 pc)
	A	mm ²				pcs	kg
Three-phase feeder terminals							
MS116, MS132, MO132	65	25	Flat	S1-M1-25	1SAM201907R1101	10	0.038
	65	25	High	S1-M2-25	1SAM201907R1102	10	0.051
	65	25	UL/CSA Type E/F and IEC	S1-M3-25	1SAM201907R1103	10	0.042
	100	35	UL/CSA Type E/F and IEC	S1-M3-35	1SAM201913R1103	10	0.060

Suitable for	Description	Type	Order code	Pkg qty	Weight (1 pc)
				pcs	kg
MS116, MS132, MO132	Protection cover for busbars	BS1-3	1SAM201908R1001	50	0.003
MS116, MS132, MO132, MS132-T	Screw fixing kit	FS116	1SAM201909R1001	1	0.020
	Padlock + two keys	SA2	GJF1101903R0002	10	0.020
MS116	Lock handle	SA1	GJF1101903R0001	10	0.003
	Lock handle box SA1/SA2	SA3	GJF1101903R0003	10	0.050

Accessories for single-phase connection (IEC only)

MS116, MS132, MO132, MS132-T	Phase connecting link	PB1-1-32	1SAM201914R1001	1	0.009
	Phase power infeed block	S1-PB1-25	1SAM201914R1002	1	0.013

Main accessories

MS165, MO165

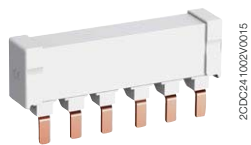

PS2-2-0-125

2CDC241002V0015



PS2-3-0-125

2CDC241003V0015



KA165

2CDC241010V0014



BS2-3

2CDC241001V0015



SA2

2CDC241023F0013

Description

Three-phase busbars ensure a quick and safe connection and are therefore a cost effective solution. A variety of different three-phase busbars up to 125 A are in the assortment. Between 2 and 5 manual motor starters with none, one or two lateral auxiliary contacts can be connected.

Ordering details

Suitable for	Rated operational current A	Number of MMS	Number of lateral aux.	Type	Order code	Pkg qty pcs	Weight (1 pc) kg
Three-phase busbars							
MS165, MO165	125	2	0	PS2-2-0-125	1SAM401920R1002	10	0.100
	125	3	0	PS2-3-0-125	1SAM401920R1003	10	0.162
	125	4	0	PS2-4-0-125	1SAM401920R1004	10	0.226
	125	2	2	PS2-2-2-125	1SAM401920R1022	10	0.117
	125	3	2	PS2-3-2-125	1SAM401920R1023	10	0.197
	125	4	2	PS2-4-2-125	1SAM401920R1024	10	0.277

Other busbar types on request.

Suitable for	Description	Type	Order code	Pkg qty pcs	Weight (1 pc) kg
MS165, MO165	Terminal shroud	KA165	1SAM401922R1001	10	0.025
	Protection cover for busbars	BS2-3	1SAM401921R1001	10	0.005
	Padlock + two keys	SA2	GJF1101903R0002	10	0.020

Main accessories





MS116, MS132, MS165, MO132, MO165

General technical data

Type	PS1-xxx-65	PS1-xxx-100	S1-Mx-25	S1-Mx-35
Standards	IEC/EN 60947-4-1, IEC/EN 60947-1, UL 60947-1, UL 60947-4-1 (UL 508), CSA C22.2 No.60947-4-1 (CSA C22.2 No.14)			
Rated operational voltage U_n	690 V			
Rated operational voltage U_n acc. to UL/CSA	600 V AC			
Rated operational current I_n	65 A	100 A	65 A	100 A
Rated operational current I_n acc. to UL/CSA	65 A	92 A	65 A	92 A
Rated frequency	50/60 Hz			
Rated impulse withstand voltage U_{imp}	6 kV			
Rated insulation voltage U_i	690 V AC			
Pollution degree	3			
Cross-section	10 mm ²	16 mm ²	25 mm ²	35 mm ²
Ambient air temperature	Operation	-25 ... +70 °C		
	Storage	-50 ... +80 °C		
Resistance to shock acc. to IEC 60068-2-27	25g / 11 ms			
Resistance to vibrations acc. to IEC 60068-2-6	5g / 3 ... 150 Hz			

Electrical connection

Main circuit

Type	S1-Mx-25	S1-Mx-35
Connecting capacity		
 Rigid	1 x 6 ... 25 mm ²	10 ... 35 mm ²
 Flexible with ferrule	1 x 6 ... 16 mm ²	10 ... 35 mm ²
 Flexible with insulated ferrule	1 x 6 ... 16 mm ²	10 ... 35 mm ²
 Flexible	1 x 6 ... 16 mm ²	10 ... 35 mm ²
Stranded acc. to UL/CSA	1 x AWG 10-4	AWG 8-2
Stripping length	10 mm	12 mm
Tightening torque	2.5 Nm / 22 lb.in	4.5 Nm / 40 lb.in
Recommended screw driver	Pozidriv 2	Hexagon SW4

Technical data for PS2-xxx on request.

Main accessories

MS116, MS132, MO132



IB132-Y

2CDC241004F0010



IB132-G

2CDC241003F0010



DMS132-Y

2CDC241002F0010



DMS132-G

2CDC241001F0010

Description

IB132 are IP65 (UL/CSA Type 12) enclosures for single MMS installation. Additional mounting of auxiliary and signaling contacts, shunt trips and undervoltage release is possible. The handle is lockable in OFF position. For detailed specification see installation instruction.

DMS132 are IP65 (UL/CSA Type 12) door mounting kits for MMS installation in any enclosure. Additional mounting of auxiliary, signaling, shunt trips and undervoltage release is possible. The handle is lockable in OFF position. For detailed specification see installation instruction.

Ordering details

Suitable for	Description	Color	Type	Order code	Pkg qty	Weight (1 pc)
					pcs	kg
IP65 enclosures (UL/CSA Type 12)						
MS116, MS132, MO132	Padlockable max. 3 padlocks with bail diameter 4 ... 6.5 mm	Yellow/red	IB132-Y	1SAM201911R1011	1	0.370
		Grey/black	IB132-G	1SAM201911R1010	1	0.370
IP65 door mounting kits (UL/CSA Type 12)						
MS116, MS132, MO132	Padlockable max. 3 padlocks with bail diameter 4 ... 6.5 mm	Yellow/red	DMS132-Y	1SAM201912R1011	1	0.170
		Grey/black	DMS132-G	1SAM201912R1010	1	0.170

Indication I-O-T and ON-OFF-T

Please check for further equipment chapter General accessories.

Main dimensions mm, inches

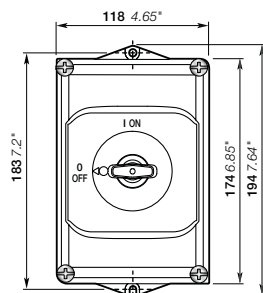

IB132

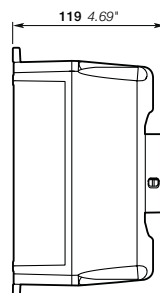

2CDC242011F0011

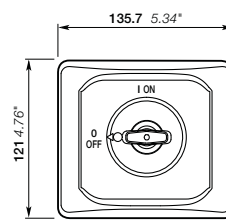

DMS132

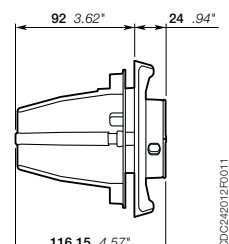

2CDC242012F0011

2CDC131050C0201

MS5100, MS495, MS497 manual motor starters

22 to 100 A – with thermal and electromagnetic protection

2



MS5100-100 no mirror

MS5100-100



1SBC1011B4F0014

MS495-40



2CDC241020F0011

MS497-100

Description

Manual motor starters (MMS) are protection devices for the main circuit. They combine motor control and protection in a single device. MMS are used mainly to switch motors manually ON/OFF and protect them and the installation fuse-less against short-circuit, overload and phase failures ¹⁾. Fuse-less protection with a manual motor starter saves costs, space and ensures a quick reaction under short-circuit condition, by switching off the motor within milliseconds.

Ordering details

Rated operational power 400 V AC-3 kW	Setting range A	Short-circuit breaking capacity I_{cs} at 400 V AC kA	Rated instantaneous short-circuit current setting I_i A	Type	Order code	Weight (1 pc) kg
MS5100 manual motor starters						
45	40 ... 100 ²⁾	70	240 ... 1300	MS5100-100	1SDA082034R1	1.200
MS495 manual motor starters						
30	45 ... 63	25	819	MS495-63	1SAM550000R1007	2.247
37	57 ... 75	25	975	MS495-75	1SAM550000R1008	2.253
45	70 ... 90	25	1170	MS495-90	1SAM550000R1009	2.280
55	80 ... 100	25	1235	MS495-100	1SAM550000R1010	2.295
MS497 manual motor starters						
15	22 ... 32	50	416	MS497-32	1SAM580000R1004	2.222
18.5	28 ... 40	50	520	MS497-40	1SAM580000R1005	2.203
22	36 ... 50	50	650	MS497-50	1SAM580000R1006	2.230
30	45 ... 63	50	819	MS497-63	1SAM580000R1007	2.255
37	57 ... 75	50	975	MS497-75	1SAM580000R1008	2.266
45	70 ... 90	50	1170	MS497-90	1SAM580000R1009	2.268
55	80 ... 100	50	1235	MS497-100	1SAM580000R1010	2.275

¹⁾ The MS49x range offers phase loss sensitivity

²⁾ For motor loads only up to 80 A

Main dimensions mm, inches

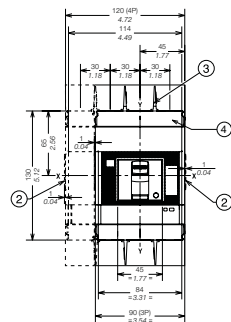

MS5100

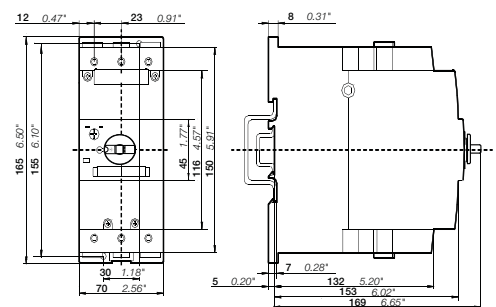
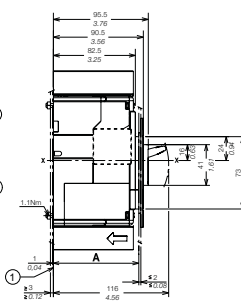

MS495, MS497

Technical data

MS5100, MS495, MS497 manual motor starters

Main circuit – Utilization characteristics according to IEC/EN

Type	MS5100	MS495, MS497
Standards	IEC/EN 60947-2	IEC/EN 60947-2, IEC/EN 60947-4-1, IEC/EN 60947-1
Rated operational voltage U_n	690 V AC	690 V AC / 450 V DC
Rated frequency	50/60 Hz	50/60 Hz
Trip class	3E, 5E, 10E, 20E	10
Number of poles	3	3
Duty time		100 %
Mechanical durability	25000 cycles	50000 cycles
Electrical durability	8000 cycles	25000 cycles
Rated impulse withstand voltage U_{imp}	8 kV	6 kV
Rated insulation voltage U_i	1000 V AC	690 V AC
Rated operational current I_n	See ordering details	
Rated instantaneous short-circuit current setting I_{sc}	See ordering details	
Rated service short-circuit breaking capacity I_{cs}	See table "Short-circuit breaking capacity and back-up fuses"	
Rated ultimate short-circuit breaking capacity I_{cu}	See table "Short-circuit breaking capacity and back-up fuses"	

Short-circuit breaking capacity and back-up fuses

- I_{cs} Rated service short-circuit breaking capacity
- I_{cu} Rated ultimate short-circuit breaking capacity
- I_{cc} Prospective short-circuit current at installation location

Note: Maximum rated current of the back-up fuses if $I_{cc} > I_{cs}$

Type	240 V AC			400 V AC			440 V AC			500 V AC			690 V AC		
	I_{cs} kA	I_{cu} kA	gG, aM A	I_{cs} kA	I_{cu} kA	gG, aM A	I_{cs} kA	I_{cu} kA	gG, aM A	I_{cs} kA	I_{cu} kA	gG, aM A	I_{cs} kA	I_{cu} kA	gG, aM A

Short-circuit protection MS5100

MS5100-100	100	100	-	70	70	-	65	65	-	30	30	-	15	15	-
------------	-----	-----	---	----	----	---	----	----	---	----	----	---	----	----	---

Short-circuit protection MS495

MS495-40	No back-up fuse required up to $I_{cc} = 100$ kA	25	50	125	20	50	125	6	12	125	3	6	63
MS495-50		25	50	125	20	50	125	6	12	125	3	6	80
MS495-63		25	50	160	20	50	160	6	12	160	3	6	80
MS495-75		25	50	160	20	50	160	6	8	160	3	5	100
MS495-90		25	50	160	20	50	160	6	8	160	3	5	125
MS495-100		25	50	160	20	50	160	6	8	160	3	5	125

MS495-40: No need for back-up fuse in networks with a prospective current of up to 50 kA at 400 V.

With an appropriate 125 A type gG fuse the device can be used in a network with a prospective current of up to 100 kA.

MS495-100: No need for back-up fuse in networks with a prospective current of up to 50 kA at 400 V.

With an appropriate 160 A type gG fuse the device can be used in a network with a prospective current of up to 100 kA.

Short-circuit protection MS497

MS497-32	No back-up fuse required up to $I_{cc} = 100$ kA	50	100	No back-up fuse required up to $I_{cc} = 100$ kA	50	100	No back-up fuse required up to $I_{cc} = 100$ kA	11	22	100	7	12	63	
MS497-40		50	100		50	100		9	18	160	6	12	80	
MS497-50		50	100		50	100		7.5	15	160	5	10	100	
MS497-63		50	100		50	70		200	7.5	15	160	4	7.5	100
MS497-75		50	100		50	70		200	5	10	160	3	6	125
MS497-90		50	100		50	70		200	5	10	160	3	6	160
MS497-100		50	100		50	70		200	5	10	160	3	6	160

MS497-32: No need for back-up fuse in networks with a prospective current of up to 100 kA at 440 V.

MS497-90: No need for back-up fuse in networks with a prospective current of up to 70 kA at 440 V.

With an appropriate 200 A type gG fuse the device can be used in a network with a prospective current of up to 100 kA.

Technical data

MS495, MS497 manual motor starters

Main circuit – Utilization characteristics according to UL/CSA

Type	MS495, MS497	
Standards	UL 508, CSA 22.2 No. 14	
Maximum operational voltage	600 V AC	
Manual motor controller ratings	See table "UL 508 – Manual motor controller"	
Trip rating	125 % FLA	
Motor ratings	Horsepower	See table "Motor ratings, three-phase"
	Full Load Amps (FLA)	See table "Motor ratings, three-phase"

Motor ratings, three-phase

hp Horsepower

FLA Full Load Amps

Type	General purpose rating at max. 600 V AC		200 - 208 V AC		230 V AC	460 V AC	575 V AC
	A	FLA	hp	hp	hp	hp	hp
MS495-63	63	63	20	25	25	50	60
MS495-75	75	75	25	25	25	60	75
MS495-90	90	90	30	30	30	75	100
MS495-100	100	100	40	40	40	75	100
MS497-32	32	32	10	10	10	25	30
MS497-40	40	40	15	15	15	30	40
MS497-50	50	50	15	20	20	40	50
MS497-63	63	63	20	25	25	50	60
MS497-75	75	75	25	25	25	60	75
MS497-90	90	90	30	30	30	75	100
MS497-100	100	100	30	40	40	75	100

UL 508 – Manual motor controller

Type	Circuit breaker or class R fuse per UL/NEC		Max. circuit breaker or fuse per UL/NEC		Maximum short-circuit current for motor disconnect				UL 508	
	480/600 V		480/600 V		for group installation		for tap conductor	for protection	Type E ¹⁾	Type E
	A	A	480 V kA	600 V kA	480 V kA	600 V kA	480Y/277V kA	600Y/347V kA	480Y/277V kA	600Y/347V kA
MS495-63	250	500	65	30	65	30	65	30	65	30
MS495-75	300	500	65	30	65	30	65	30	65	30
MS495-90	350	500	65	10	65	10	65	-	65	-
MS495-100	400	500	65	10	65	10	65	-	65	-
MS497-32	120	500	65	30	65	30	65	30	65	30
MS497-40	160	500	65	30	65	30	65	30	65	30
MS497-50	200	500	65	30	65	30	65	30	65	30
MS497-63	250	500	65	30	65	30	65	30	65	30
MS497-75	300	500	65	30	65	30	65	30	65	30
MS497-90	350	500	65	10	65	10	-	-	65	-
MS497-100	400	500	65	10	65	10	-	-	65	-

¹⁾ only with use DX495

Technical data

MS5100, MS495, MS497 manual motor starters

General technical data

Type	MS5100 ¹⁾	MS495	MS497
Pollution degree	3	3	
Phase loss sensitivity		Yes	
Disconnect function acc. to IEC/EN 60947-2	Yes	Yes	
Ambient air temperature			
Operation			
Open - compensated	-	-20 ... +60 °C	
Open	-25 ... +70 °C	-20 ... +70 °C	
Enclosed	-25 ... +70 °C	-20 ... +35 °C	
Storage	-40 ... +70 °C	-50 ... +80 °C	
Ambient air temperature compensation	Acc. to IEC/EN60947-4-1	Acc. to IEC/EN60947-4-1	
Maximum operating altitude permissible	2000 m	2000 m	
Resistance to shock acc. to IEC 60068-2-27	12g / 11 ms	-	
Resistance to vibrations acc. to IEC 60068-2-6	0.7g / 13 ... 100 Hz	2g / 5-150 Hz	
Mounting position	Horizontal, vertical, or lying down position	Position 1-6 (optional for single mounting)	
Mounting	-	DIN-rail 15 mm / 75 mm (EN 60715)	
Minimum distance to other units same type			
Horizontal	0 mm	0 mm	
Vertical - up to 240 V		50 mm	
Vertical - up to 440 V		70 mm	
Vertical - up to 500 V		110 mm	
Vertical - up to 690 V		150 mm	
Vertical		-	
Minimum distance to electrical conductive board			
Horizontal	See "Insulation distances for installation in metallic cubicles"	-	
Horizontal - up to 500 V		10 mm	
Horizontal - up to 690 V		30 mm	
Vertical - up to 240 V		50 mm	
Vertical - up to 440 V		70 mm	
Vertical - up to 500 V		110 mm	
Vertical - up to 690 V		150 mm	
Vertical		-	
Degree of protection			
Housing	IP40 (on the lever)	IP20	
Main circuit terminals	IP00	IP00	

¹⁾ For $U_n > 440$ V power supply only from the upper terminal/lugs

Insulation distances for installation in metallic cubicles

Manual motor starter	A mm/in	B mm/in	C mm/in
MS5100			

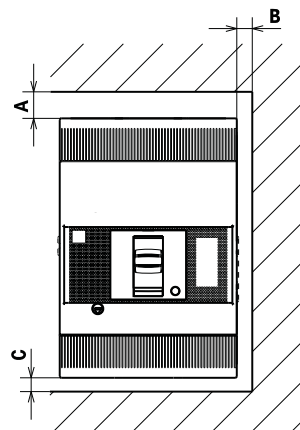



MS5100, insulation distances

Technical data

MS5100, MS495, MS497 manual motor starters

Connecting characteristics

Main circuit

Type	MS495	MS497
Connecting capacity		
 Rigid	1 or 2 x 2.5 ... 16 mm ²	2.5 ... 16 mm ²
 Flexible with ferrule	1 x 10 ... 70 mm ² 2 x 10 ... 50 mm ²	10 ... 70 mm ² 10 ... 50 mm ²
 Flexible	1 x 10 ... 70 mm ² 2 x 10 ... 50 mm ²	10 ... 70 mm ² 10 ... 50 mm ²
Stranded acc. to UL/CSA	1 x AWG 10-2/0 2 x AWG 10-1/0	AWG 10-2/0 AWG 10-1/0
Flexible acc. to UL/CSA	1 x AWG 10-2/0 2 x AWG 10-1/0	AWG 10-2/0 AWG 10-1/0
Stripping length	17 mm	17 mm
Tightening torque	4 - 6 Nm / 35 - 53 lb.in	4 - 6 Nm / 35 - 53 lb.in
Recommended screw driver	Hexagon 4	Hexagon 4

Front terminals - F (UL Listed)

Type	MS5100
Vers.	F
Busbar dimensions	
W min	13 mm
W max	20 mm
H	7.5 mm
Ø	6.5 mm
D min	2.5 mm
D max	5 mm
Cable terminals	
W	20 mm
Ø	6.5 mm
Tightening torque	6 Nm / 53.1 lb.in
Recommended screw driver	M6



Front terminal - F



F terminal with cable lug



F terminal with busbar

MO5100, MO495, MO496 manual motor starters magnetic only 32 to 100 A – with electromagnetic protection



MO5100-100 no meter

MO5100-100



5102801

MO495-75



2CDC241021F0011

MO496-100

Description

The manual motor starter magnetic only is used to manually switch on and off motors and to protect them reliably and without the need for a fuse from short-circuits.

Ordering details

Rated operational power 400 V AC-3 ¹⁾ kW	Rated operational current A	Short-circuit breaking capacity I_{cs} at 400 V AC kA	Rated instantaneous short-circuit current setting I_i A	Type	Order code	Weight (1 pc) kg
MO5100 manual motor starter magnetic only						
25	70	36 ²⁾	210 ... 770	MO5100-70	1SDA082031R1	1.100
30	80	36 ²⁾	240 ... 880	MO5100-80	1SDA082032R1	1.100
45	100	36 ²⁾	300 ... 1100	MO5100-100	1SDA082033R1	1.100
MO495 manual motor starter magnetic only						
30	63	25	819	MO495-63	1SAM560000R1007	2.244
37	75	25	975	MO495-75	1SAM560000R1008	2.247
45	90	25	1170	MO495-90	1SAM560000R1009	2.269
55	100	25	1235	MO495-100	1SAM560000R1010	2.292
MO496 manual motor starter magnetic only						
15	32	50	416	MO496-32	1SAM590000R1004	2.208
18.5	40	50	520	MO496-40	1SAM590000R1005	2.218
22	50	50	650	MO496-50	1SAM590000R1006	2.218
30	63	50	819	MO496-63	1SAM590000R1007	2.248
37	75	50	975	MO496-75	1SAM590000R1008	2.278
45	90	50	1170	MO496-90	1SAM590000R1009	2.266
55	100	50	1235	MO496-100	1SAM590000R1010	2.293

¹⁾ For overload protection of motors, an appropriate thermal or electronic overload relay must be used

²⁾ I_{cs} at 415 V AC

Main dimensions mm, inches

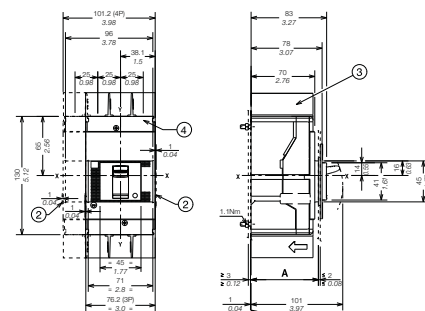

MO5100

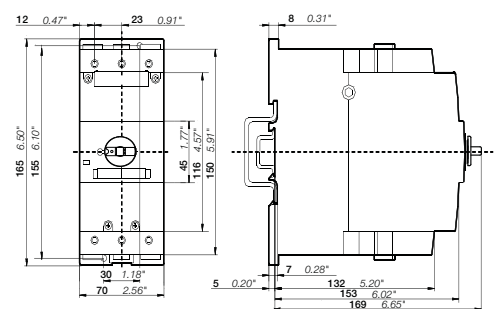

MO495, MO496

Technical data

MO5100, MO495, MO496 manual motor starters magnetic only

Main circuit – Utilization characteristics according to IEC/EN

Type	MO5100	MO495, MO496
Standards	IEC/EN 60947-2	IEC/EN 60947-2, IEC/EN 60947-4-1, IEC/EN 60947-1
Rated operational voltage U_n	690 V AC / 500 V DC	690 V AC / 450 V DC
Rated frequency	50/60 Hz	50/60 Hz
Number of poles	3	3
Duty time	-	100 %
Mechanical durability	25000 cycles	50000 cycles
Electrical durability	8000 cycles	25000 cycles
Rated impulse withstand voltage U_{imp}	8 kV	6 kV
Rated insulation voltage U_i	800 V AC	690 V AC
Rated operational current I_n	See ordering details	
Rated instantaneous short-circuit current setting I_i	See ordering details	
Rated service short-circuit breaking capacity I_{cs}	See table "Short-circuit breaking capacity and back-up fuses"	
Rated ultimate short-circuit breaking capacity I_{cu}	See table "Short-circuit breaking capacity and back-up fuses"	

Short-circuit breaking capacity and back-up fuses

I_{cs} Rated service short-circuit breaking capacity

I_{cu} Rated ultimate short-circuit breaking capacity

I_{cc} Prospective short-circuit current at installation location

Note: Maximum rated current of the back-up fuses if $I_{cc} > I_{cs}$

Type	240 V AC			400 V AC			440 V AC			500 V AC			690 V AC		
	I_{cs} kA	I_{cu} kA	gG, aM A	I_{cs} kA	I_{cu} kA	gG, aM A	I_{cs} kA	I_{cu} kA	gG, aM A	I_{cs} kA	I_{cu} kA	gG, aM A	I_{cs} kA	I_{cu} kA	gG, aM A
Short-circuit protection MO5100															
MO5100-70	48.75	65	-	36	36	-	18	36	-	11	22	-	4.5	6	-
MO5100-80	48.75	65	-	36	36	-	18	36	-	11	22	-	4.5	6	-
MO5100-100	48.75	65	-	36	36	-	18	36	-	11	22	-	4.5	6	-

Short-circuit protection MO495

MO495-63		25	50	160	20	50	160	6	12	160	3	6	80
MO495-75	No back-up fuse required up to $I_{cc} = 100$ kA	25	50	160	20	50	160	6	8	160	3	5	100
MO495-90		25	50	160	20	50	160	6	8	160	3	5	125
MO495-100		25	50	160	20	50	160	6	8	160	3	5	125

MO495-100: No need for back-up fuse in networks with a prospective current of up to 50 kA at 400 V.

With an appropriate 160 A type gG fuse the device can be used in a network with a prospective current of up to 100 kA.

Short-circuit protection MO496

MO496-32	No back-up fuse required up to $I_{cc} = 100$ kA	50	100	No back-up fuse required up to $I_{cc} = 100$ kA	50	100	No back-up fuse required up to $I_{cc} = 100$ kA	11	22	100	7	12	63
MO496-40		50	100		50	100	9	18	160	6	12	80	
MO496-50		50	100		50	100	7.5	15	160	5	10	100	
MO496-63		50	100		50	70	200	7.5	15	160	4	7.5	100
MO496-75		50	100		50	70	200	5	10	160	3	6	125
MO496-90		50	100		50	70	200	5	10	160	3	6	160
MO496-100		50	100		50	70	200	5	10	160	3	6	160

MO496-32: No need for back-up fuse in networks with a prospective current of up to 100 kA at 440 V.

MO496-90: No need for back-up fuse in networks with a prospective current of up to 70 kA at 440 V.

With an appropriate 200 A type gG fuse the device can be used in a network with a prospective current of up to 100 kA.

Technical data

MO495, MO496 manual motor starters magnetic only

Main circuit – Utilization characteristics according to UL/CSA

Type	MO495, MO496	
Standards	UL 508, CSA 22.2 No. 14	
Maximum operational voltage	600 V AC	
Manual motor controller ratings	See table "UL 508 – Manual motor controller"	
Trip rating	125 % FLA	
Motor ratings	Horsepower	See table "Motor ratings, three-phase"
	Full Load Amps (FLA)	See table "Motor ratings, three-phase"

2

Motor ratings, three-phase

hp Horsepower

FLA Full Load Amps

Type	General purpose rating at max. 600 V AC	Full Load Amps	200 - 208 V AC	230 V AC	460 V AC	575 V AC
	A	FLA	hp	hp	hp	hp
MO495-63	63	63	20	25	50	60
MO495-75	75	75	25	25	60	75
MO495-90	90	90	30	30	75	100
MO495-100	100	100	40	40	75	100
MO496-32	32	32	10	10	25	30
MO496-40	40	40	15	15	30	40
MO496-50	50	50	15	20	40	50
MO496-63	63	63	20	25	50	60
MO496-75	75	75	25	25	60	75
MO496-90	90	90	30	30	75	100
MO496-100	100	100	30	40	75	100

UL 508 – Manual motor controller

Type	Circuit breaker or class R fuse per UL/NEC	Max. circuit breaker or fuse per UL/NEC	Maximum short-circuit current for motor disconnect			
	480/600 V	480/600 V	480 V		for group installation	
	A	A	kA	600 V kA	480 V kA	600 V kA
MO495-63	60	500	65	30	65	30
MO495-75	250	500	65	30	65	30
MO495-90	300	500	65	30	65	30
MO495-100	350	500	65	10	65	10
MO496-32	120	500	65	30	65	30
MO496-40	160	500	65	30	65	30
MO496-50	200	500	65	30	65	30
MO496-63	250	500	65	30	65	30
MO496-75	300	500	65	30	65	30
MO496-90	350	500	65	10	65	10
MO496-100	400	500	65	10	65	10

Technical data

MO5100, MO495, MO496 manual motor starters magnetic only

General technical data

Type	MO5100	MO495	MO496
Pollution degree	3	3	
Phase loss sensitivity		-	
Disconnect function acc. to IEC/EN 60947-2	Yes	Yes	
Ambient air temperature			
Operation			
Open - compensated	-	-20 ... +60 °C	
Open	-25 ... +70 °C	-20 ... +70 °C (above 60° C, current derating)	
Enclosed	-25 ... +70 °C	-20 ... +35 °C	
Storage	-40 ... +70 °C	-50 ... +80 °C	
Ambient air temperature compensation	-	-	
Maximum operating altitude permissible	2000 m	2000 m	
Resistance to shock acc. to IEC 60068-2-27	12g / 11 ms	25g / 11 ms	
Resistance to vibrations acc. to IEC 60068-2-6	0.7g / 13 ... 100 Hz	-	
Mounting position	Horizontal, vertical, or lying down position	Position 1-6 (optional for single mounting)	
Mounting	-	DIN-rail 15 mm / 75 mm (EN 60715)	
Minimum distance to other units same type			
Horizontal	0 mm	0 mm	
Vertical - up to 240 V		50 mm	
Vertical - up to 440 V		70 mm	
Vertical - up to 500 V		110 mm	
Vertical - up to 690 V		150 mm	
Vertical		-	
Minimum distance to electrical conductive board			
Horizontal	See "Insulation distances for installation in metallic cubicles"	-	
Horizontal - up to 500 V		10 mm	
Horizontal - up to 690 V		30 mm	
Vertical - up to 240 V		50 mm	
Vertical - up to 440 V		70 mm	
Vertical - up to 500 V		110 mm	
Vertical - up to 690 V		150 mm	
Vertical		-	
Degree of protection			
Housing	IP40 (on the lever)	IP20	
Main circuit terminals	IP00	IP20	

Insulation distances for installation in metallic cubicles

Manual motor starter	A mm/in	B mm/in	C mm/in
MO5100			

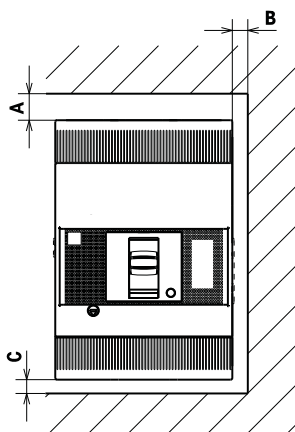



MO5100, insulation distances

Technical data

MO5100, MO495, MO496 manual motor starters magnetic only

Connecting characteristics

Main circuit

Type		MO495	MO496
Connecting capacity			
 Rigid	1 or 2 x	2.5 ... 16 mm ²	2.5 ... 16 mm ²
 Flexible with ferrule	1 x	10 ... 70 mm ²	10 ... 70 mm ²
	2 x	10 ... 50 mm ²	10 ... 50 mm ²
 Flexible	1 x	10 ... 70 mm ²	10 ... 70 mm ²
	2 x	10 ... 50 mm ²	10 ... 50 mm ²
Stranded acc. to UL/CSA	1 x	AWG 10-2/0	AWG 10-2/0
	2 x	AWG 10-1/0	AWG 10-1/0
Flexible acc. to UL/CSA	1 x	AWG 10-2/0	AWG 10-2/0
	2 x	AWG 10-1/0	AWG 10-1/0
Stripping length			
		17 mm	17 mm
Tightening torque			
		4 - 6 Nm / 35 - 53 lb.in	4 - 6 Nm / 35 - 53 lb.in
Recommended screw driver			
		Hexagon 4	Hexagon 4

Front terminals - F (UL Listed)

Type	MS5100
Vers.	F
Busbar dimensions	
W min	13 mm
W max	16 mm
H	7.5 mm
Ø	6.5 mm
D min	3.5 mm
D max	5 mm
Cable terminals	
W	16 mm
Ø	6.5 mm
Tightening torque	
	6 Nm / 53.1 lb.in
Recommended screw driver	
	M6



Front terminal - F



F terminal with cable lug



F terminal with busbar

Main accessories

MS5100, MO5100 manual motor starters

2



XT AUX-Con eaw#01

AUX-C



XT SOR-Con eaw#01

SOR-C



1SDCz1 0C96F0001

KLC Ronis

Description

Manual motor starters can be equipped with auxiliary contacts, undervoltage release and shunt trips. Undervoltage release are used for remote tripping of the manual motor starter especially for emergency stop circuits. Shunt trips release the MMS used for remote tripping. For this manual motor starter range we also offer key lock solutions for customer applications.

Ordering details

Suitable for	Auxiliary contacts N.O.	Auxiliary contacts N.C.	Description	Type	Order code	Pkg qty	Weight (1 pc)
						pcs	kg

Auxiliary contacts - mountable inside the breaker on the left slot (cabled version)

MS5100,			Changeover	AUX-C 1Q+1SY 250V AC	1SDA066431R1	2	0.06
MO5100			Changeover	AUX-C 2Q+1SY 250V AC	1SDA066433R1	3	0.09
MS5100			Changeover	AUX-C 2Q+2SY+1SA 250V AC	1SDA066438R1	5	0.15
			Changeover	AUX-C 3Q+1SY 250V AC	1SDA066434R1	4	0.12
MO5100			Changeover	AUX-C 3Q+2SY 250V AC	1SDA066436R1	5	0.15
			Changeover	AUX-C 1Q+1SY 24V DC	1SDA066446R1	2	0.06

Suitable for	Rated control supply voltage V	Description	Type	Order code	Pkg qty	Weight (1 pc)
					pcs	kg

Shunt trips units - mountable inside the breaker on the left slot (cabled version)

MS5100, MO5100		Normally NON energized	SOR-C 12V DC	1SDA066321R1	1	0.14
		Normally NON energized	SOR-C 24-30V AC/DC	1SDA066322R1	1	0.14
		Normally NON energized	SOR-C 48-60V AC/DC	1SDA066323R1	1	0.14
		Normally NON energized	SOR-C 110-127V AC / 110-125V DC	1SDA066324R1	1	0.14
		Normally NON energized	SOR-C 220-240V AC / 220-250V DC	1SDA066325R1	1	0.14
		Normally NON energized	SOR-C 380-440V AC	1SDA066326R1	1	0.14
		Normally NON energized	SOR-C 480-525V AC	1SDA066327R1	1	0.14

Undervoltages releases - mountable inside the breaker on the left slot (cabled version)

MS5100, MO5100		Normally energized	UVR-C 24-30V AC/DC	1SDA066396R1	1	0.14
		Normally energized	UVR-C 48V AC/DC	1SDA060965R1	1	0.14
		Normally energized	UVR-C 60V AC/DC	1SDA066397R1	1	0.14
		Normally energized	UVR-C 110-127V AC / 110-125V DC	1SDA066398R1	1	0.14
		Normally energized	UVR-C 220-240V AC / 220-250V DC	1SDA066399R1	1	0.14
		Normally energized	UVR-C 380-440V AC	1SDA066400R1	1	0.14
		Normally energized	UVR-C 480-525V AC	1SDA066401R1	1	0.14

Suitable for	Description	Type	Order code	Pkg qty	Weight (1 pc)
				pcs	kg

Key locks

MS5100	Key lock on the circuit breaker, different keys, removable in open position	KLC Ronis ¹⁾	1SDA066599R1	1	NA
MO5100	Key lock on the circuit breaker, different keys, removable in open position	KLC Ronis ¹⁾	1SDA066593R1	1	NA

¹⁾ UL Listed

Main accessories

MS49x, MO49x manual motor starters

Manual motor starter MS49x with accessories

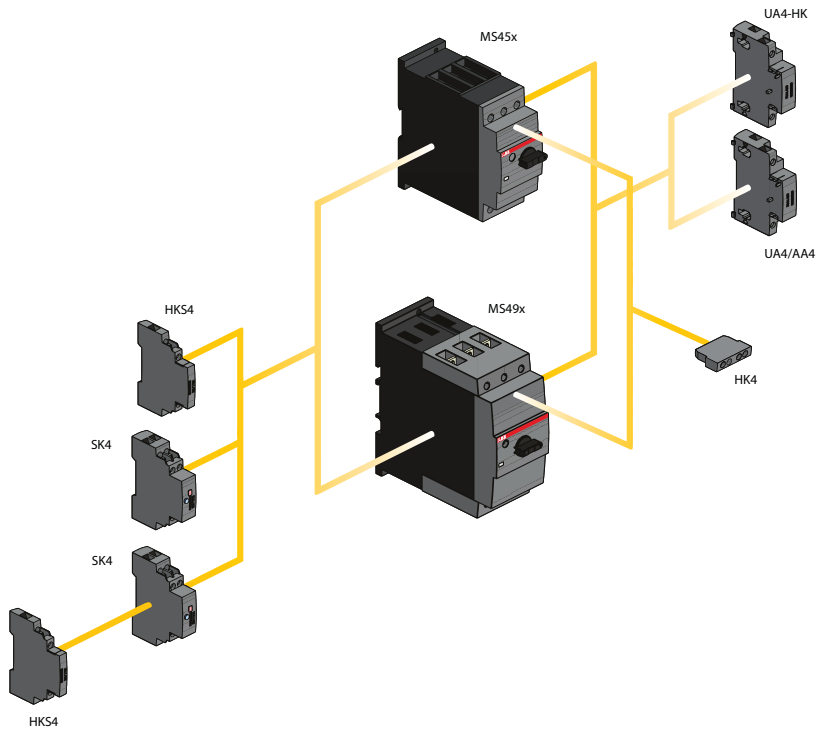

Manual motor starter MO49x with accessories

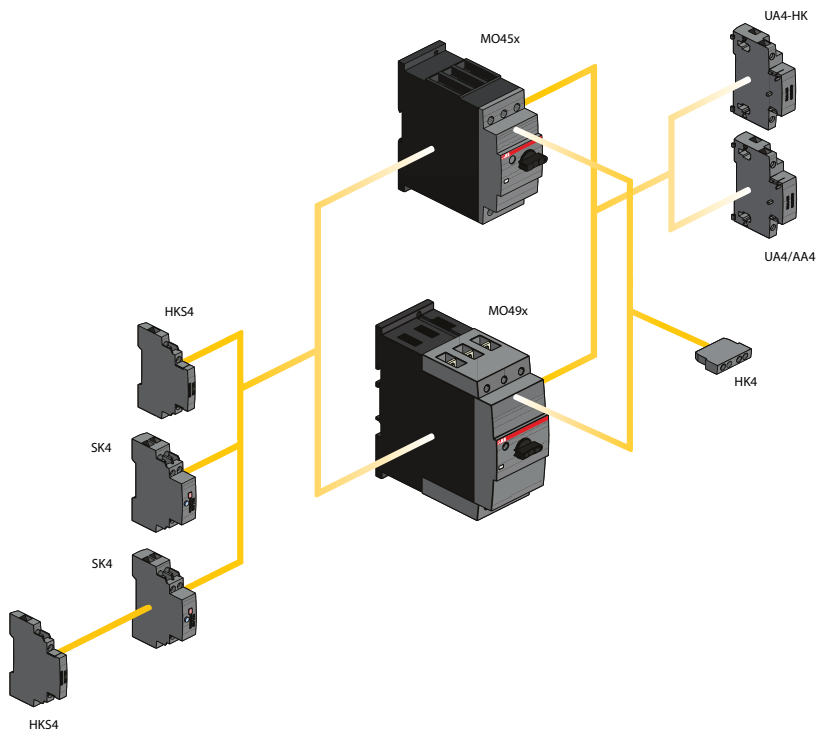

Main accessories

MS49x, MO49x manual motor starters

2



2CDC241022F0011

HK4-11



2CDC241022F0011

HKS4-20



2CDC241024F0011

SK4-11



2CDC241028F0011

AA4-24



2CDC241025F0011

UA4-110



2CDC241023F0013

SA2

Description

Manual motor starters can be equipped with auxiliary contacts for lateral/front mounting, signalling contact for lateral mounting, undervoltage release and shunt trips. The accessories can be fitted wiring free and without tools. A variety of combinations is possible as required for the application. The auxiliary contacts change position with the main contacts. Undervoltage release are used for remote tripping of the manual motor starter especially for emergency stop circuits. Shunt trips release the MMS used for remote tripping. For this manual motor starter range we offer terminal shrouds, terminal insulation barriers and different lock/key solutions for customer solutions.

Ordering details

Suitable for	Auxiliary con- tacts N.O.	Auxiliary con- tacts N.C.	Description	Type	Order code	Pkg qty	Weight (1 pc)
						pcs	kg

Auxiliary contacts – mountable on the front

MS49x, MO49x	1	1		HK4-11	1SAM401901R1001	10	0.017
			Changeover	HK4-W	1SAM401901R1002	10	0.015

Auxiliary contacts – mountable on the left

MS49x, MO49x	1	1	Max. 1 piece	HKS4-11	1SAM401902R1001	2	0.045
	2	0	Max. 1 piece	HKS4-20	1SAM401902R1002	2	0.045
	0	2	Max. 1 piece	HKS4-02	1SAM401902R1003	2	0.045

Signalling contacts – mountable on the left

MS49x, MO49x	2	2	Separate signalling acc. UL508E 1 N.O. + 1 N.C. for short circuit alarm and 1 N.O. + 1 N.C. for tripped alarm, max. 1x SK4-11 + 1 x HKS4-xx	SK4-11	1SAM401904R1001	1	0.093
-----------------	---	---	--	--------	-----------------	---	-------

Suitable for	Rated control supply voltage	Frequency	Type	Order code	Pkg qty	Weight (1 pc)
	V	Hz			pcs	kg

Shunt trip units – mountable on the right

MS49x, MO49x	20 ... 24	50/60	AA4-24	1SAM401907R1001	1	0.135
	90 ... 110	50/60	AA4-110	1SAM401907R1002	1	0.135
	200 ... 240	50/60	AA4-230	1SAM401907R1003	1	0.128
	350 ... 415	50/60	AA4-400	1SAM401907R1004	1	0.125

Undervoltage releases – mountable on the right

MS49x, MO49x	24	50/60	UA4-24	1SAM401905R1004	1	0.134
	110/120	50/60	UA4-110	1SAM401905R1001	1	0.134
	230/240	50/60	UA4-230	1SAM401905R1002	1	0.131
	400/440	50/60	UA4-400	1SAM401905R1003	1	0.129
	230/240	50/60	UA4-HK-230	1SAM401906R1001	1	0.140
	400/440	50/60	UA4-HK-400	1SAM401906R1002	1	0.137

Suitable for	Description	Type	Order code	Pkg qty	Weight (1 pc)
				pcs	kg
MS495, MS497, MO495, MO496	Terminal shroud	KA495	1SAM501901R1001	10	0.018
	Terminal shroud	KA495C ¹⁾	1SAM501902R1001	10	0.038
	Terminal insulation barrier for UL508E	DX495	1SAM401912R1001	1	0.154
MS495, MS497, MO495, MO496	Padlock + two keys	SA2	GJF1101903R0002	10	0.020

¹⁾ Is plugged onto the housing after removing the box terminals, if using cable lugs.

Main accessories

MS49x, MO49x manual motor starters

General technical data

Type	HK4-11	HK4-W	HKS4	SK4
Standards	IEC/EN 60947-1, IEC/EN 60947-5-1, UL 508, CSA22.2 No. 14			
Rated operational voltage U_e	230 V AC / 220 V DC	690 V AC / 220 V DC	690 V AC	690 V AC
Conventional free-air thermal current I_{th}	2.5 A	5 A	10 A	10 A
Rated frequency	DC, 50/60 Hz			
Rated impulse withstand voltage U_{imp}	6 kV			
Rated insulation voltage U_i	300 V	300 V	690 V	690 V
Pollution degree	3			
Ambient air temperature	Operation Storage			
	-20 ... +70 °C -50 ... +80 °C			
Resistance to shock acc. to IEC 60068-2-27	25g / 11 ms			
Resistance to vibrations acc. to IEC 60068-2-6	2g / 5 ... 150 Hz			
Number of poles	1 N.C. + 1 N.O.	Changeover	1 N.C. + 1 N.O. / 2 N.O. / 2 N.C.	2 N.C. + 2 N.O.
I_e / Rated operational current AC-15 acc. to IEC/EN 60947-5-1 for utilization category				
	24 V	2 A	4 A	6 A
	230 V	0.5 A	3 A	4 A
	400 V	-	1.5 A	3 A
	690 V	-	0.5 A	1 A
I_e / Rated operational current DC-13 acc. to IEC/EN 60947-5-1 for utilization category				
	24 V	1 A	1 A	2 A
	48 V	0.3 A	-	-
	60 V	0.15 A	-	-
	110 V	-	0.22 A	0.5 A
	230 V	-	0.1 A	0.25 A
Minimum switching capacity	17 V / 1 mA			
Short-circuit protective device	10 A Type gG			
Duty time	100 %			
Mounting	Front of MMS	Front of MMS	Left side of MMS	Left side of MMS
Mounting positions	1-6			
Mechanical durability	100000 cycles			
Electrical durability	100000 cycles			



Type	UA4-xxx	AA4-xxx
Power consumption		
Pull-in	AC 20.2/13 VA/W DC 20 W	20.2/13 VA/W 13 ... 80 W
Holding	AC 7.2/2.4 VA/W DC 2.1 W	- -
Operating voltage		
Tripping	0.35 ... 0.7 V x U_e	0.7 ... 1.1 V x U_e
Coil operating voltage	0.85 ... 1.1 V x U_e	-

Main accessories

MS49x, MO49x manual motor starters

Connecting characteristics

Auxiliary circuit

Type		HK4-11	HK4-W	HKS4	SK4
Connecting capacity					
 Rigid	1 x	0.5... 2.5 mm ²			
	2 x	0.5 ... 1.5 mm ² or 0.75 ... 2.5 mm			
 Flexible with ferrule	1 x	0.5 ... 2.5 mm ²			
	2 x	0.5 ... 1.5 mm ² or 0.75 ... 2.5 mm			
 Flexible	1 x	0.5 ... 2.5 mm ²			
	2 x	0.5 ... 1.5 mm ² or 0.75 ... 2.5 mm			
	Stranded acc. to UL/CSA	1 or 2 x	AWG 18-14		
	Flexible acc. to UL/CSA	1 or 2 x	AWG 18-14		
Stripping length					
10 mm					
Tightening torque					
0.8 ... 1.2 Nm / 7 ... 10.3 lb.in					
Recommended screw driver					
Pozidriv 2					

2

General accessories

MS1xx, MO1xx, MS5100, MO5100, MS49x, MO49x



MSHD-LB

2CDC241003F0011



MSHD-LY

2CDC241002S0011



MSMN

2CDC241004F0011



MSH-AR

2CDC241001F0012

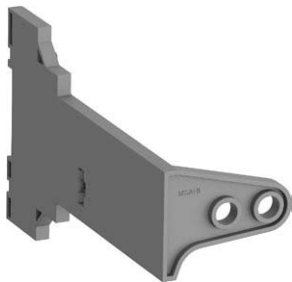

MSAH1

2CDC241017V0013



RHD Normal Direct Handle

RHD-01

Description

With this solution of door coupling rotary mechanism it is possible to operate a manual motor starter in the back of a switch cabinet from outside. The door coupling mechanism prevents opening of the door of a switch cabinet with the manual motor starter in ON position.

The complete mechanism includes handle, shaft, driver, shaft alignment ring and shaft supporter.

Most accessories fit for 6 mm shafts with a maximum length of 180 mm. The degree of protection for handles MSHD is IP64 (UL/CSA Type 1, 3R, 12).

Ordering details

Suitable for	Description	Shaft length mm	Color	Type	Order code	Pkg qty pcs	Weight (1 pc) kg
Shafts							
MS116, MS132, MO132, MS165, MO165, MS4xx, MO4xx	For MSHD handles. Shaft diameter 6 mm. Shaft extension for door coupling driver.	85 105 130 180		OXS6X85 OXS6X105 OXS6X130 OXS6X180	1SCA101647R1001 1SCA108043R1001 1SCA101655R1001 1SCA101659R1001	1 1 1 1	0.020 0.020 0.030 0.040
IP64 handles (UL/CSA Type 1, 3R, 12)							
MS116, MS132, MO132, MS165, MO165, MS4xx, MO4xx	Padlockable max. 3 padlocks with bail diameter 5 ... 8 mm, door interlock in ON position defeatable, for use with 6 mm OXS6...types up to 180 mm or driver shafts MSOX.		Black Yellow Black Yellow	MSHD-LB ¹⁾ MSHD-LY ¹⁾ MSHD-LTB ²⁾ MSHD-LTY ²⁾	1SAM201920R1001 1SAM201920R1002 1SAM201920R1011 1SAM201920R1012	1 1 1 1	0.065 0.065 0.065 0.065
Driver							
MS116, MS132, MO132, MS165, MO165, MS4xx, MO4xx	Coupling driver for use with 6 mm OXS6... types up to 180 mm.			MSMN ³⁾ MSMNO ⁴⁾	1SAM101923R0002 1SAM101923R0012	1 1	0.002 0.002
Shaft alignment ring							
MS116, MS132, MO132, MS165, MO165, MS4xx, MO4xx	The MSH-AR supports the long shafts for alignment to the handle inlet. It makes closing panel doors more easy. Use for OXS6X > 105 mm.			MSH-AR	1SAM201920R1000	1	0.010
Shaft supporter							
MS116, MS132, MO132	With the MSAH1 it is possible to support the shaft in the extension of handle (MSHD). It is mandatory for the usage of shafts >130 mm.			MSAH1	1SAM201909R1021	1	0.035
Rotary handle operating mechanism							
MS5100	Rotary handle operating mechanism			RHD Normal Direct Handle ⁵⁾	1SDA069053R1	1	0.4
MO5100	Rotary handle operating mechanism			RHD Normal Direct Handle ⁵⁾	1SDA066475R1	1	0.4

¹⁾ Indication I-O and ON-OFF (recommended for MS116, MS4xx, MO4xx)

²⁾ Indication I-O and ON-OFF + Trip indication

³⁾ Coded - Positioning of ON indication dependent from mounting orientation of the MMS

⁴⁾ Uncoded - Positioning of ON indication independent from mounting orientation of the MMS

⁵⁾ UL Listed

General accessories

MS1xx, MO1xx, MS4xx, MO4xx

2

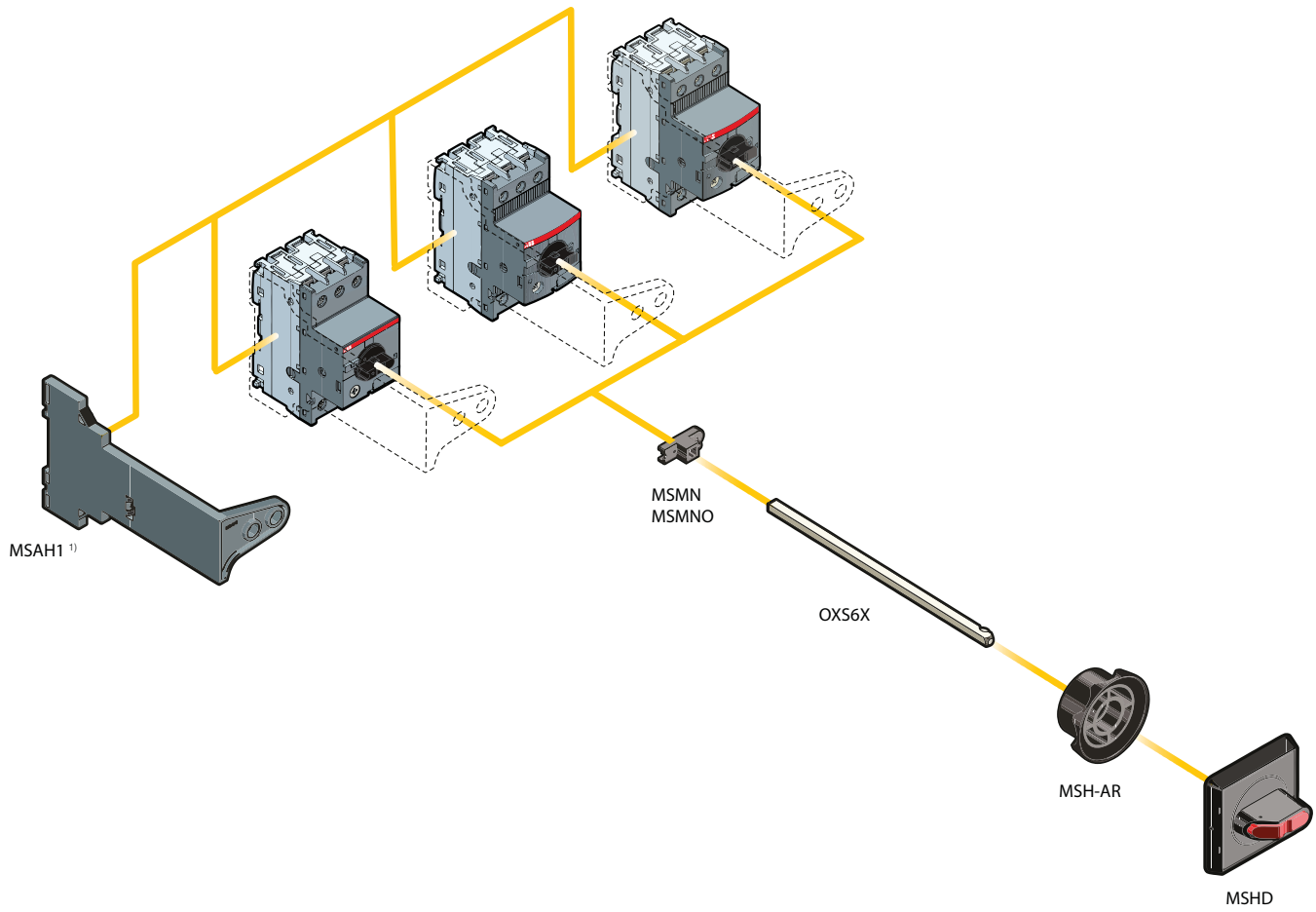

¹⁾ MSAH1 fits to MS116, MS132 and MO132

2CDC024022 F0013

Notes

A series of horizontal dotted lines for writing notes.



B mini contactors

K mini contactor relays

With screw terminals

3-pole contactors

B6, B7 AC operated	3/4
BC6, BC7, B7D DC operated	3/5

3-pole reversing contactors

VB6, VB7 AC operated	3/6
VBC6, VBC7 DC operated	3/7
VB6A, VB7A AC operated	3/8
VBC6A, VBC7A DC operated	3/9

3-pole interface contactors

BC6, BC7 DC operated	3/10
----------------------	------

3-pole contactors - large coil voltage range

TBC7 DC operated	3/11
------------------	------

4-pole contactors

B6, B7 AC operated	3/12
BC6, B7D DC operated	3/13

4-pole contactors - large coil voltage range

TBC7 DC operated	3/14
------------------	------

Contactors relays

K6 AC operated	3/15
KC6 DC operated	3/16

Interface contactor relays

KC6 DC operated	3/17
-----------------	------

Contactors relays - large coil voltage range

TKC6 DC operated	3/18
------------------	------

With soldering pins

3-pole contactors

B6, B7 AC operated	3/19
BC6, BC7 DC operated	3/20

3-pole reversing contactors

VB6, VB7 AC operated	3/21
VBC6, VBC7 DC operated	3/22
VB6A, VB7A AC operated	3/23
VBC7A DC operated	3/24

Contactors relays

K6 AC operated	3/25
KC6 DC operated	3/26

3-pole interface contactors

BC6, BC7 DC operated	3/27
----------------------	------

Interface contactor relays

KC6 DC operated	3/28
-----------------	------

With flat pin connection

3-pole contactors

B6, B7 AC operated	3/29
BC6, BC7 DC operated	3/30

3-pole reversing contactors

VB7 AC operated	3/31
VBC7 DC operated	3/32
VB7A AC operated	3/33
VBC7A DC operated	3/34

3-pole interface contactors

BC6, BC7 DC operated	3/35
----------------------	------

Contactors relays

K6 AC operated	3/36
KC6 DC operated	3/37

Interface contactor relays



KC6 DC operated	3/38
-----------------	------

Accessories	3/39
--------------------	-------------

Technical data	3/41
-----------------------	-------------

Mini contactors



			Screw terminals			
AC Control supply 						
3-pole contactors	Coil consumption 3.5 W	Type	B6	B7	-	-
3-pole reversing contactors	Coil consumption 3.5 W	Type	-	-	VB6 VB6A²⁾	VB7 VB7A²⁾
4-pole contactors	Coil consumption 3.5 W	Type	B6	B7	-	-
DC Control supply 						
3-pole contactors	Coil consumption 3.5 W	Type	BC6	BC7 B7D¹⁾	-	-
3-pole interface contactors	Coil consumption 1.4 ... 2.4 W	Type	BC6	BC7	-	-
3-pole reversing contactors	Coil consumption 3.5 W	Type	-	-	VBC6 VBC6A²⁾	VBC7 VBC7A²⁾
4-pole contactors	Coil consumption 3.5 W	Type	BC6	B7D	-	-
Wide range types	Extended coil voltage and temperature	Type	-	TBC7	-	-
PLC types	Coil consumption 1.7 W	Type	B6S¹⁾	B7S¹⁾	-	-
IEC Rated operational power AC-3	220-230-240 V	kW	2.2	3	2.2	3
	380-400 V	kW	4	5.5	4	5.5
Rated operational current AC-1	400 V, $\theta \leq 40^\circ\text{C}$	A	20	20	20	20
		A	2	3	2	3
UL/CSA 3-phase motor rating	220-240 V AC	hp	2	3	2	3
	440-480 V AC	hp	3	5	3	5
General use rating		A	12 (300 V)	16 (600 V)	12 (300 V)	16 (600 V)

¹⁾ With integrated surge suppressor

²⁾ With safety blocking function

Main accessories

Auxiliary contact blocks	Front mounting	CAF6
	Side mounting	CA6
Connection sets	For reversing contactors	BSM6-30
Surge suppressors	Varistor (AC/DC)	RV-BC6

Overload relays



Thermal overload relays	Class 10	T16
Thermal and phase failure protection, with single setup possible		
Electronic overload relays	Class 10E, 20E, 30E	E16DU
With single setup possible		

Manual motor starters

Thermal / magnetic protection	Class 10	MS116, MS132
Magnetic only types		MO132
Connecting link to manual motor starters		BEA7/132

Contactor relays



			Screw terminals			
AC Control supply 						
4-pole contactor relays	Coil consumption 3.5 W	Type	K6			
DC Control supply 						
4-pole contactor relays	Coil consumption 3.5 W	Type	KC6			
4-pole interface contactor relays	Coil consumption 1.4 ... 2.4 W	Type	KC6			
Wide range types	Extended coil voltage and temperature	Type	TKC6			
IEC Rated operational current AC-15	220-230-240 V	A	4			
	380-400 V	A	3			
Rated operational current DC-13	24 V	A	2.5			

Main accessories

Auxiliary contact blocks	Front mounting	CAF6
	Side mounting	CA6-11K



Soldering pins				Flat pins			
B6...P	B7...P	-	-	B6...F	B7...F	-	-
-	-	VB6...P	VB7...P	-	-	VB6...F	VB7...F
-	-	VB6A...P ²⁾	VB7A...P ²⁾	-	-	VB6A...F ²⁾	VB7A...F ²⁾
BC6...P	BC7...P	-	-	BC6...F	BC7...F	-	-
BC6...P	B7D...P ¹⁾	-	-	BC6...F	B7D...F ¹⁾	-	-
-	BC7...P	-	-	BC6...F	BC7...F	-	-
-	-	VBC6...P	VBC7...P	-	-	VBC6...F	VBC7...F
-	-	VBC6A...P ²⁾	VBC7A...P ²⁾	-	-	VBC6A...F ²⁾	VBC7A...F ²⁾
2.2	3	2.2	3	2.2	3	2.2	3
4	5.5	4	5.5	4	5.5	4	5.5
12	12	12	12	20	20	20	20
2	3	2	3	2	3	2	3
3	5	3	5	3	5	3	5
12 (300 V)	16 (600 V)	12 (300 V)	16 (600 V)	12 (300 V)	16 (600 V)	12 (300 V)	16 (600 V)

-	CA6-11K-P	-	CA6-11K-F
-	-	-	-
-	-	-	-

-	-	-	-
-	-	-	-

MS116, MS132	MS116, MS132
MO132	MO132
-	-



Soldering pins		Flat pins	
K6...P		K6...F	
KC6...P		KC6...F	
KC6...P		KC6...F	
4		4	
3		3	
2.5		2.5	
-	CA6-11K-P	-	CA6-11K-F

B6, B7 3-pole mini contactors – with screw terminals

4 to 5.5 kW

AC operated



2CDC211001R0010

B6-30-10



2CDC211014R0011

B7-30-10

Description

B6, B7 3-pole mini contactors are compact control products mainly used for switching resistive or motor loads up to 690 V AC.

These contactors are designed with:

- 3 main poles and one built-in auxiliary contact
- control circuit: AC operated
 - low coil consumption (3.5 VA at pull-in and at holding)
- add-on auxiliary contact blocks for front or side mounting and a wide range of accessories
- hum-free coil
- designed for rail or wall mounting

Ordering details

IEC	UL/CSA	Rated control circuit voltage U_c	Auxiliary contacts fitted	Type	Order code	Pkg qty	Weight (1 pce)
Rated operational power AC-3 kW	current $\theta \leq 40^\circ\text{C}$ AC-1 A 3-phase motor rating hp	General use rating	50 Hz V AC	60 Hz V AC			kg

B6 mini contactors

4	20	3	300 V / 12 A	24	24	1 0	B6-30-10-01	GJL1211001R0101	10	0.175
				42	42	0 1	B6-30-01-01	GJL1211001R0011	10	0.175
				48	48	1 0	B6-30-10-02	GJL1211001R0102	10	0.175
						0 1	B6-30-01-02	GJL1211001R0012	10	0.175
						1 0	B6-30-10-03	GJL1211001R0103	10	0.175
						0 1	B6-30-01-03	GJL1211001R0013	10	0.175
				110 ... 127	110 ... 127	1 0	B6-30-10-84	GJL1211001R8104	10	0.175
						0 1	B6-30-01-84	GJL1211001R8014	10	0.175
				220 ... 240	220 ... 240	1 0	B6-30-10-80	GJL1211001R8100	10	0.175
						0 1	B6-30-01-80	GJL1211001R8010	10	0.175
				380 ... 415	380 ... 415	1 0	B6-30-10-85	GJL1211001R8105	10	0.175
						0 1	B6-30-01-85	GJL1211001R8015	10	0.175

B7 mini contactors

5.5	20	5	600 V / 16 A	24	24	1 0	B7-30-10-01	GJL1311001R0101	10	0.175
				42	42	0 1	B7-30-01-01	GJL1311001R0011	10	0.175
				48	48	1 0	B7-30-10-02	GJL1311001R0102	10	0.175
						0 1	B7-30-01-02	GJL1311001R0012	10	0.175
						1 0	B7-30-10-03	GJL1311001R0103	10	0.175
						0 1	B7-30-01-03	GJL1311001R0013	10	0.175
				110 ... 127	110 ... 127	1 0	B7-30-10-84	GJL1311001R8104	10	0.175
						0 1	B7-30-01-84	GJL1311001R8014	10	0.175
				220 ... 240	220 ... 240	1 0	B7-30-10-80	GJL1311001R8100	10	0.175
						0 1	B7-30-01-80	GJL1311001R8010	10	0.175
				380 ... 415	380 ... 415	1 0	B7-30-10-85	GJL1311001R8105	10	0.175
						0 1	B7-30-01-85	GJL1311001R8015	10	0.175

Other types on request

Main dimensions mm, inches

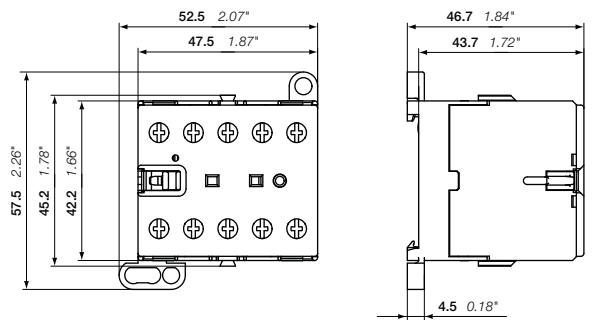

B6, B7

BC6, BC7, B7D 3-pole mini contactors – with screw terminals

4 to 5.5 kW

DC operated



BC6-30-10

2CDC21104RF0011



BC7-30-10

2CDC211019F0011

Description

BC6, BC7, B7D 3-pole mini contactors are compact control products mainly used for switching resistive or motor loads up to 690 V AC.

These contactors are designed with:

- 3 main poles and one built-in auxiliary contact
- control circuit: DC operated, low consumption (3.5 W at pull-in and at holding)
- hum-free coil
- add-on auxiliary contact blocks for front or side mounting and a wide range of accessories
- designed for rail or wall mounting

Ordering details

IEC	UL/CSA	Rated control circuit voltage: U_c	Auxiliary contacts fitted	Type	Order code	Pkg qty	Weight (1 pce)
Rated operational power 400 V AC-3 kW	3-phase motor current rating $\theta \leq 40^\circ\text{C}$ AC-1 A hp 480 V	General use rating					kg

BC6 mini contactors

Rated operational power (kW)	3-phase motor current rating (A)	General use rating (hp)	Rated control circuit voltage (V DC)	Auxiliary contacts fitted	Type	Order code	Pkg qty	Weight (1 pce) (kg)
4	20	3	300 V / 12 A	1 0	BC6-30-10-07	GJL1213001R0107	10	0.175
				0 1	BC6-30-01-07	GJL1213001R0017	10	0.175
				1 0	BC6-30-10-01	GJL1213001R0101	10	0.175
				0 1	BC6-30-01-01	GJL1213001R0011	10	0.175
				1 0	BC6-30-10-16	GJL1213001R1106	10	0.175
				0 1	BC6-30-01-16	GJL1213001R1016	10	0.175
				1 0	BC6-30-10-03	GJL1213001R0103	10	0.175
				0 1	BC6-30-01-03	GJL1213001R0013	10	0.175
				1 0	BC6-30-10-04	GJL1213001R0104	10	0.175
				0 1	BC6-30-01-04	GJL1213001R0014	10	0.175
				1 0	BC6-30-10-05	GJL1213001R0105	10	0.175
				0 1	BC6-30-01-05	GJL1213001R0015	10	0.175

BC7 mini contactors

Rated operational power (kW)	3-phase motor current rating (A)	General use rating (hp)	Rated control circuit voltage (V DC)	Auxiliary contacts fitted	Type	Order code	Pkg qty	Weight (1 pce) (kg)
5.5	20	5	600 V / 16 A	1 0	BC7-30-10-07	GJL1313001R0107	10	0.175
				0 1	BC7-30-01-07	GJL1313001R0017	10	0.175
				1 0	BC7-30-10-01	GJL1313001R0101	10	0.175
				0 1	BC7-30-01-01	GJL1313001R0011	10	0.175
				1 0	BC7-30-10-16	GJL1313001R1106	10	0.175
				0 1	BC7-30-01-16	GJL1313001R1016	10	0.175
				1 0	BC7-30-10-03	GJL1313001R1103	10	0.175
				0 1	BC7-30-01-03	GJL1313001R0013	10	0.175
				1 0	BC7-30-10-04	GJL1313001R0104	10	0.175
				0 1	BC7-30-01-04	GJL1313001R0014	10	0.175
				1 0	BC7-30-10-05	GJL1313001R0105	10	0.175
				0 1	BC7-30-01-05	GJL1313001R0015	10	0.175

B7D mini contactors with integrated suppressor diode

Rated operational power (kW)	3-phase motor current rating (A)	General use rating (hp)	Rated control circuit voltage (V DC)	Auxiliary contacts fitted	Type	Order code	Pkg qty	Weight (1 pce) (kg)
5.5	20	5	600 V / 16 A	1 0	B7D-30-10-01	GJL1317001R0101	10	0.175
				0 1	B7D-30-01-01	GJL1317001R0011	10	0.175
				1 0	B7D-30-10-05	GJL1317001R0105	10	0.175
				0 1	B7D-30-01-05	GJL1317001R0015	10	0.175

Other types on request

Main dimensions mm, inches

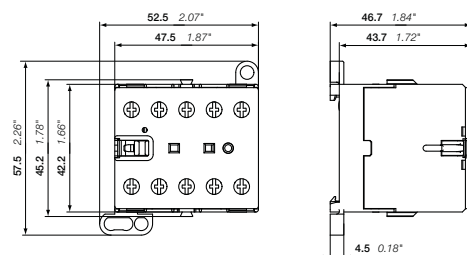

BC6, BC7, B7D

2CDC212001F0011

2CDC102015C0201

VB6, VB7 3-pole mini reversing contactors – with screw terminals

4 to 5.5 kW

AC operated



2CDC211005F0011

3

VB7-30-10

Description

VB6, VB7 3-pole compact design reversing contactors are space optimized control products mainly used for switching resistive or motor loads up to 690 V AC.

These reversing contactors are designed with:

- built-in mechanical interlock. The coils must be mutually interlocked electrically and coils must be de-energised for 50 ms at least to prevent phase to phase short circuit on the arc.
- control circuit: AC operated
 - low coil consumption (3.5 VA at pull-in and at holding)
 - hum-free coil
- add-on auxiliary contact blocks for front mounting
- designed for rail or wall mounting

Ordering details

IEC Rated power 400 V AC-3 kW	operational current 0 ≤ 40 °C AC-1 A	UL/CSA 3-phase motor rating 480 V hp	General use rating	Rated control circuit voltage U _c		Auxiliary contacts fitted 	Type	Order code	Pkg qty	Weight (1 pce) kg				
				50 Hz V AC	60 Hz V AC									
VB6 mini reversing contactors														
4	20	3	300 V / 12 A	24	24	1 0	VB6-30-10-01	GJL1211901R0101	5	0.355				
					42	42	0 1	VB6-30-01-01	GJL1211901R0011	5	0.355			
				48	48	1 0	VB6-30-10-02	GJL1211901R0102	5	0.355				
						0 1	VB6-30-01-02	GJL1211901R0012	5	0.355				
				110 ... 127	110 ... 127	1 0	VB6-30-10-03	GJL1211901R0103	5	0.355				
						0 1	VB6-30-01-03	GJL1211901R0013	5	0.355				
				220 ... 240	220 ... 240	1 0	VB6-30-10-84	GJL1211901R8104	5	0.355				
						0 1	VB6-30-01-84	GJL1211901R8014	5	0.355				
				380 ... 415	380 ... 415	1 0	VB6-30-10-80	GJL1211901R8100	5	0.355				
						0 1	VB6-30-01-80	GJL1211901R8010	5	0.355				
				380 ... 415	380 ... 415	1 0	VB6-30-10-85	GJL1211901R8105	5	0.355				
						0 1	VB6-30-01-85	GJL1211901R8015	5	0.355				
				VB7 mini reversing contactors										
				5.5	20	5	600 V / 16 A	24	24	1 0	VB7-30-10-01	GJL1311901R0101	5	0.355
42	42	0 1	VB7-30-01-01						GJL1311901R0011	5	0.355			
48	48	1 0	VB7-30-10-02					GJL1311901R0102	5	0.355				
		0 1	VB7-30-01-02					GJL1311901R0012	5	0.355				
110 ... 127	110 ... 127	1 0	VB7-30-10-03					GJL1311901R0103	5	0.355				
		0 1	VB7-30-01-03					GJL1311901R0013	5	0.355				
220 ... 240	220 ... 240	1 0	VB7-30-10-84					GJL1311901R8104	5	0.355				
		0 1	VB7-30-01-84					GJL1311901R8014	5	0.355				
380 ... 415	380 ... 415	1 0	VB7-30-10-80					GJL1311901R8100	5	0.355				
		0 1	VB7-30-01-80					GJL1311901R8010	5	0.355				
380 ... 415	380 ... 415	1 0	VB7-30-10-85					GJL1311901R8105	5	0.355				
		0 1	VB7-30-01-85					GJL1311901R8015	5	0.355				

Other types on request

Main dimensions mm, inches

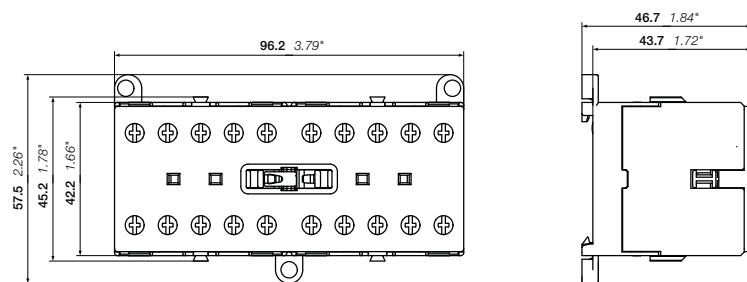

VB6, VB7

2CDC212005F0011

2CDC102016C0201

VBC6, VBC7 3-pole mini reversing contactors – with screw terminals

4 to 5.5 kW

DC operated



VBC6-30-10

2CDC211049R0011



VBC7-30-10

2CDC211001R0011

Description

VBC6, VBC7 3-pole compact design reversing contactors are space optimized control products mainly used for switching resistive or motor loads up to 690 V AC.

These reversing contactors are designed with:

- built-in mechanical interlock. The coils must be mutually interlocked electrically and coils must be de-energised for 50 ms at least to prevent phase to phase short circuit on the arc.
- control circuit: DC operated
 - low coil consumption (3.5 W at pull-in and at holding)
- hum-free coil
- add-on auxiliary contact blocks for front mounting
- designed for rail or wall mounting

Ordering details

IEC	UL/CSA	Rated control circuit voltage: U _c	Auxiliary contacts fitted	Type	Order code	Pkg qty	Weight (1 pce)
Rated operational power	3-phase motor rating	General use rating					kg
400 V AC-3 kW	AC-1 A hp	300 V / 12 A	V DC				

VBC6 mini reversing contactors

Rated operational power	3-phase motor rating	General use rating	Rated control circuit voltage: U _c	Auxiliary contacts fitted	Type	Order code	Pkg qty	Weight (1 pce)
4	20	3	300 V / 12 A	1 0	VBC6-30-10-07	GJL1213901R0107	5	0.355
				0 1	VBC6-30-01-07	GJL1213901R0017	5	0.355
				1 0	VBC6-30-10-01	GJL1213901R0101	5	0.355
				0 1	VBC6-30-01-01	GJL1213901R0011	5	0.355
				1 0	VBC6-30-10-16	GJL1213901R1106	5	0.355
				0 1	VBC6-30-01-16	GJL1213901R1016	5	0.355
				1 0	VBC6-30-10-03	GJL1213901R0103	5	0.355
				0 1	VBC6-30-01-03	GJL1213901R0013	5	0.355
				1 0	VBC6-30-10-04	GJL1213901R0104	5	0.355
				0 1	VBC6-30-01-04	GJL1213901R0014	5	0.355
				1 0	VBC6-30-10-05	GJL1213901R0105	5	0.355
				0 1	VBC6-30-01-05	GJL1213901R0015	5	0.355

VBC7 mini reversing contactors

Rated operational power	3-phase motor rating	General use rating	Rated control circuit voltage: U _c	Auxiliary contacts fitted	Type	Order code	Pkg qty	Weight (1 pce)
5.5	20	5	600 V / 16 A	1 0	VBC7-30-10-07	GJL1313901R0107	5	0.355
				0 1	VBC7-30-01-07	GJL1313901R0017	5	0.355
				1 0	VBC7-30-10-01	GJL1313901R0101	5	0.355
				0 1	VBC7-30-01-01	GJL1313901R0011	5	0.355
				1 0	VBC7-30-10-16	GJL1313901R1106	5	0.355
				0 1	VBC7-30-01-16	GJL1313901R1016	5	0.355
				1 0	VBC7-30-10-03	GJL1313901R0103	5	0.355
				0 1	VBC7-30-01-03	GJL1313901R0013	5	0.355
				1 0	VBC7-30-10-04	GJL1313901R0104	5	0.355
				0 1	VBC7-30-01-04	GJL1313901R0014	5	0.355
				1 0	VBC7-30-10-05	GJL1313901R0105	5	0.355
				0 1	VBC7-30-01-05	GJL1313901R0015	5	0.355

Other types on request

Main dimensions mm, inches

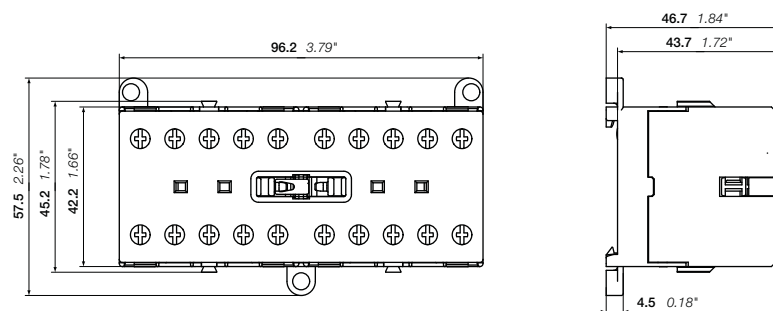

VBC6, VBC7

2CDC212005R0011

2CDC102017C0201

VB6A, VB7A 3-pole mini reversing contactors – with screw terminals

4 to 5.5 kW

AC operated – with safety blocking function



2CDC211039F0011

3 VB6A-30-10



2CDC211039F0011

VB7A-30-10

Description

VB6A, VB7A 3-pole compact design reversing contactors are space optimized control products mainly used for switching resistive or motor loads up to 690 V AC.

These reversing contactors are designed with:

- built-in mechanical interlock and safety blocking function. The safety blocking function is triggered if the voltage is applied to the coil of the contactor to be switched on before the contactor to be switched off has dropped out. The contactor coils are designed for continuous operation when the contactor is de-energised i.e. the coil is not damaged if the mechanical interlock prevents switch-on of the contactor with the coil voltage applied.
- control circuit: AC operated
 - low coil consumption (3.5 VA at pull-in and at holding)
 - hum-free coil
- add-on auxiliary contact blocks for front mounting
- designed for rail or wall mounting

Ordering details

IEC Rated operational power	Rated operational current $\theta \leq 40^\circ\text{C}$	UL/CSA 3-phase motor rating	General use rating	Rated control circuit voltage U_c		Auxiliary contacts fitted	Type	Order code	Pkg qty	Weight (1 pce)
				50 Hz	60 Hz					
400 V AC-3 kW	AC-1 A	hp		V AC	V AC					kg

VB6A mini reversing contactors with safety blocking function

4	20	3	300 V / 12 A	24	24	1 0	VB6A-30-10-01	GJL1211911R0101	5	0.355
						0 1	VB6A-30-01-01	GJL1211911R0011	5	0.355
				42	42	1 0	VB6A-30-10-02	GJL1211911R0102	5	0.355
						0 1	VB6A-30-01-02	GJL1211911R0012	5	0.355
				48	48	1 0	VB6A-30-10-03	GJL1211911R0103	5	0.355
						0 1	VB6A-30-01-03	GJL1211911R0013	5	0.355
				110 ... 127	110 ... 127	1 0	VB6A-30-10-84	GJL1211911R8104	5	0.355
						0 1	VB6A-30-01-84	GJL1211911R8014	5	0.355
				220 ... 240	220 ... 240	1 0	VB6A-30-10-80	GJL1211911R8100	5	0.355
						0 1	VB6A-30-01-80	GJL1211911R8010	5	0.355
				380 ... 415	380 ... 415	1 0	VB6A-30-10-85	GJL1211911R8105	5	0.355
						0 1	VB6A-30-01-85	GJL1211911R8015	5	0.355

VB7A mini reversing contactors with safety blocking function

5.5	20	5	600 V / 16 A	24	24	1 0	VB7A-30-10-01	GJL1311911R0101	5	0.355
						0 1	VB7A-30-01-01	GJL1311911R0011	5	0.355
				42	42	1 0	VB7A-30-10-02	GJL1311911R0102	5	0.355
						0 1	VB7A-30-01-02	GJL1311911R0012	5	0.355
				48	48	1 0	VB7A-30-10-03	GJL1311911R0103	5	0.355
						0 1	VB7A-30-01-03	GJL1311911R0013	5	0.355
				110 ... 127	110 ... 127	1 0	VB7A-30-10-84	GJL1311911R8104	5	0.355
						0 1	VB7A-30-01-84	GJL1311911R8014	5	0.355
				220 ... 240	220 ... 240	1 0	VB7A-30-10-80	GJL1311911R8100	5	0.355
						0 1	VB7A-30-01-80	GJL1311911R8010	5	0.355
				380 ... 415	380 ... 415	1 0	VB7A-30-10-85	GJL1311911R8105	5	0.355
						0 1	VB7A-30-01-85	GJL1311911R8015	5	0.355

Other types on request

Main dimensions mm, inches

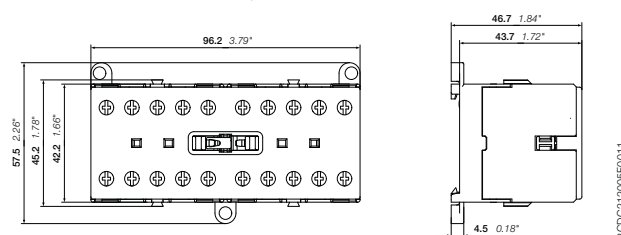

VB6A, VB7A

VBC6A, VBC7A 3-pole mini reversing contactors – with screw terminals

4 to 5.5 kW

DC operated – with safety blocking function



VBC6A-30-10

2CDC21104F0011



VBC7A-30-10

2CDC211007F0011

Description

VBC6A, VBC7A 3-pole compact design reversing contactors are space optimized control products mainly used for switching resistive or motor loads up to 690 V AC.

These reversing contactors are designed with:

- built-in mechanical interlock and safety blocking function. The safety blocking function is triggered if the voltage is applied to the coil of the contactor to be switched on before the contactor to be switched off has dropped out. The contactor coils are designed for continuous operation when the contactor is de-energised i.e. the coil is not damaged if the mechanical interlock prevents switch-on of the contactor with the coil voltage applied.
- control circuit: DC operated
 - low coil consumption (3.5 W at pull-in and at holding)
- hum-free coil
- add-on auxiliary contact blocks for front mounting
- designed for rail or wall mounting

Ordering details

IEC Rated operational power	UL/CSA 3-phase General use rating	Rated control circuit voltage: U_c	Auxiliary contacts fitted	Type	Order code	Pkg qty	Weight (1 pce)
400 V AC-3 kW	AC-1 hp	$\theta \leq 40^\circ\text{C}$ 480 V					kg

VBC6A mini reversing contactors with safety blocking function

4	20	3	300 V / 12 A	12	1 0 0 1	VBC6A-30-10-07 VBC6A-30-01-07	GJL1213911R0107 GJL1213911R0017	5	0.355
				24	1 0 0 1	VBC6A-30-10-01 VBC6A-30-01-01	GJL1213911R0101 GJL1213911R0011	5	0.355
				48	1 0 0 1	VBC6A-30-10-16 VBC6A-30-01-16	GJL1213911R1106 GJL1213911R1016	5	0.355
				60	1 0 0 1	VBC6A-30-10-03 VBC6A-30-01-03	GJL1213911R0103 GJL1213911R0013	5	0.355
				110 ... 125	1 0 0 1	VBC6A-30-10-04 VBC6A-30-01-04	GJL1213911R0104 GJL1213911R0014	5	0.355
				220 ... 240	1 0 0 1	VBC6A-30-10-05 VBC6A-30-01-05	GJL1213911R0105 GJL1213911R0015	5	0.355

VBC7A mini reversing contactors with safety blocking function

5.5	20	5	600 V / 16 A	12	1 0 0 1	VBC7A-30-10-07 VBC7A-30-01-07	GJL1313911R0107 GJL1313911R0017	5	0.355
				24	1 0 0 1	VBC7A-30-10-01 VBC7A-30-01-01	GJL1313911R0101 GJL1313911R0011	5	0.355
				48	1 0 0 1	VBC7A-30-10-16 VBC7A-30-01-16	GJL1313911R1106 GJL1313911R0016	5	0.355
				60	1 0 0 1	VBC7A-30-10-03 VBC7A-30-01-03	GJL1313911R0103 GJL1313911R0013	5	0.355
				110 ... 125	1 0 0 1	VBC7A-30-10-04 VBC7A-30-01-04	GJL1313911R0104 GJL1313911R0014	5	0.355
				220 ... 240	1 0 0 1	VBC7A-30-10-05 VBC7A-30-01-05	GJL1313911R0105 GJL1313911R0015	5	0.355

Other types on request

Main dimensions mm, inches

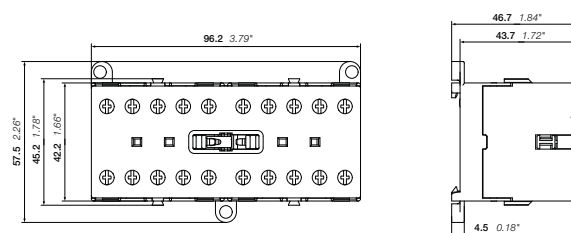

VBC6A, VBC7A

2CDC212008F0011

BC6, BC7 3-pole interface mini contactors – with screw terminals

4 to 5.5 kW

DC operated



2CDC21104P0011

BC6-30-10



2CDC21109P0011

BC7-30-10

Description

BC6, BC7 3-pole interface mini contactors are compact control products mainly used for switching resistive or motor loads up to 690 V AC.

These contactors are designed with:

- 3 main poles and one built-in auxiliary contact
- control circuit: DC operated, very low coil consumption. Suitable for direct control by PLC outputs
- hum-free coil
- no auxiliary contact block permitted for mounting
- designed for rail or wall mounting

Ordering details

IEC	UL/CSA	Rated control circuit voltage U_c	Auxiliary contacts fitted	Type	Order code	Pkg qty	Weight (1 pce)	
Rated operational power	3-phase: motor rating General use rating							
400 V AC-3 kW	$\theta \leq 40^\circ\text{C}$ AC-1 A hp	300 V / 12 A 600 V / 16 A					kg	
DC operation 24 V / 1.4 W								
4	20	3	300 V / 12 A	24	1 0 BC6-30-10-1.4-81 0 1 BC6-30-01-1.4-81	GJL1213001R8101 GJL1213001R8011	10 10	0.175 0.175
5.5	20	5	600 V / 16 A	24	1 0 BC7-30-10-1.4-81 0 1 BC7-30-01-1.4-81	GJL1313001R8101 GJL1313001R8011	10 10	0.175 0.175
DC operation 17 ... 32 V / 2.4 W								
4	20	3	300 V / 12 A	17 ... 32	1 0 BC6-30-10-2.4-51 0 1 BC6-30-01-2.4-51	GJL1213001R5101 GJL1213001R5011	10 10	0.175 0.175
5.5	20	5	600 V / 16 A	17 ... 32	1 0 BC7-30-10-2.4-51 0 1 BC7-30-01-2.4-51	GJL1313001R5101 GJL1313001R5011	10 10	0.175 0.175

Connection to PLCs with integrated protective circuit

DC operation 24 V / 1.7 W								
4	20	3	300 V / 12 A	24	1 0 B6S-30-10-1.7-71 0 1 B6S-30-01-1.7-71	GJL1213001R7101 GJL1213001R7011	10 10	0.175 0.175
5.5	20	5	600 V / 16 A	24	1 0 B7S-30-10-1.7-71 0 1 B7S-30-01-1.7-71	GJL1313001R7101 GJL1313001R7011	10 10	0.175 0.175
DC operation 17 ... 32 V / 2.8 W								
4	20	3	300 V / 12 A	17 ... 32	1 0 B6S-30-10-2.8-72 0 1 B6S-30-01-2.8-72	GJL1213001R7102 GJL1213001R7012	10 10	0.175 0.175
5.5	20	5	600 V / 16 A	17 ... 32	1 0 B7S-30-10-2.8-72 0 1 B7S-30-01-2.8-72	GJL1313001R7102 GJL1313001R7012	10 10	0.175 0.175

Other types on request

Main dimensions mm, inches

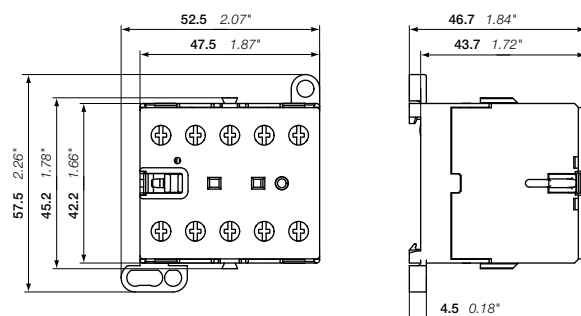

BC6, BC7

2CDC212001P0011

2CDC102010C0201

TBC7 3-pole mini contactors – with screw terminals

4 to 5.5 kW

DC operated – large coil voltage range



TBC7-30-10

Description

TBC7 3-pole mini contactors are compact control products mainly used for switching resistive or motor loads up to 690 V AC.

These contactors are designed with:

- 3 main poles and one built-in auxiliary contact
- control circuit: DC operated
 - low coil consumption (5 W at pull-in and at holding)
 - hum-free coil
- expanded ambient temperature range -30 ... +70 °C and wide range voltage supply
- no auxiliary contact block permitted for mounting
- designed for rail or wall mounting
- material is approved for railway applications

Ordering details

IEC		UL/CSA		Rated control circuit voltage: $U_{Cmin} \dots U_{Cmax}$	Auxiliary contacts fitted 	Type	Order code	Pkg qty	Weight (1 pce) kg
Rated power	operational current $\theta \leq 40 \text{ }^\circ\text{C}$	3-phase motor rating 480 V	General use rating						
400 V AC-3 kW	AC-1 A	hp		V DC					
TBC7 mini contactors									
5.5	20	5	600 V / 16 A	17 ... 32	1 0	TBC7-30-10-51	GJL1313061R5101	10	0.185
					0 1	TBC7-30-01-51	GJL1313061R5011	10	0.185
				50 ... 90	1 0	TBC7-30-10-55	GJL1313061R5105	10	0.185
					0 1	TBC7-30-01-55	GJL1313061R5015	10	0.185
				77 ... 143	1 0	TBC7-30-10-62	GJL1313061R6102	10	0.185
					0 1	TBC7-30-01-62	GJL1313061R6012	10	0.185
				140 ... 260	1 0	TBC7-30-10-68	GJL1313061R6108	10	0.185
					0 1	TBC7-30-01-68	GJL1313061R6018	10	0.185

Other types on request

Main dimensions mm, inches

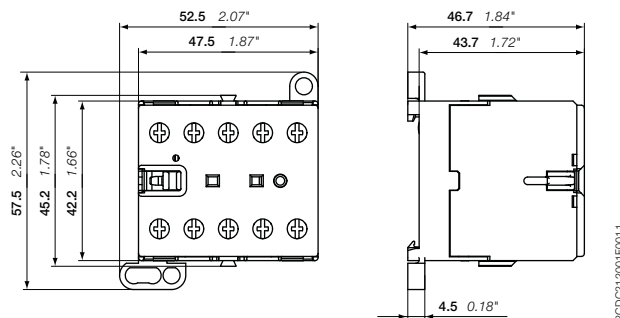

TBC7

B6, B7 4-pole mini contactors – with screw terminals

4 to 5.5 kW

AC operated



2CDC211028FX011

3

B6-22-00

Description

B6, B7 4-pole mini contactors are compact control products mainly used for switching resistive loads up to 690 V AC.

These contactors are designed with:

- 4 main poles
- control circuit: AC operated
 - low coil consumption (3.5 VA at pull-in and at holding)
- add-on auxiliary contact blocks for front or side mounting and a wide range of accessories
- hum-free coil
- designed for rail or wall mounting

Ordering details

IEC	UL/CSA	Rated control circuit voltage U_c 50/60 Hz	Auxiliary contacts fitted	Type	Order code	Pkg qty	Weight (1 pce)
Rated operational current $I_n \leq 40^\circ\text{C}$ AC-1	General use rating						
A		V AC					kg
4 N.O. main poles							
20	300 V / 12 A	24	0 0	B6-40-00-01	GJL1211201R0001	10	0.175
		42	0 0	B6-40-00-02	GJL1211201R0002	10	0.175
		48	0 0	B6-40-00-03	GJL1211201R0003	10	0.175
		110 ... 127	0 0	B6-40-00-84	GJL1211201R8004	10	0.175
		220 ... 240	0 0	B6-40-00-80	GJL1211201R8000	10	0.175
20	600 V / 16 A	24	0 0	B7-40-00-01	GJL1311201R0001	10	0.175
		42	0 0	B7-40-00-02	GJL1311201R0002	10	0.175
		48	0 0	B7-40-00-03	GJL1311201R0003	10	0.175
		110 ... 127	0 0	B7-40-00-84	GJL1311201R8004	10	0.175
		220 ... 240	0 0	B7-40-00-80	GJL1311201R8000	10	0.175
2 N.O. + 2 N.C. main poles							
20	300 V / 12 A	24	0 0	B6-22-00-01	GJL1211501R0001	10	0.175
		42	0 0	B6-22-00-02	GJL1211501R0002	10	0.175
		48	0 0	B6-22-00-03	GJL1211501R0003	10	0.175
		110 ... 127	0 0	B6-22-00-84	GJL1211501R8004	10	0.175
		220 ... 240	0 0	B6-22-00-80	GJL1211501R8000	10	0.175
20	600 V / 16 A	24	0 0	B7-22-00-01	GJL1311501R0001	10	0.175
		42	0 0	B7-22-00-02	GJL1311501R0002	10	0.175
		48	0 0	B7-22-00-03	GJL1311501R0003	10	0.175
		110 ... 127	0 0	B7-22-00-84	GJL1311501R8004	10	0.175
		220 ... 240	0 0	B7-22-00-80	GJL1311501R8000	10	0.175

Other types on request

Main dimensions mm, inches

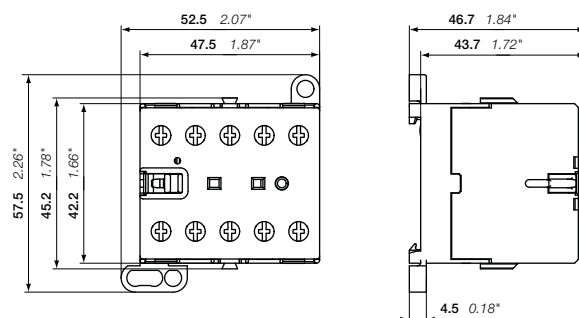

B6, B7

2CDC212001R0011

2CDC102009C0201

BC6, B7D 4-pole mini contactors – with screw terminals

4 to 5.5 kW

DC operated



BC6-22-00

Description

BC6, B7D 4-pole mini contactors are compact control products mainly used for switching resistive loads up to 690 V AC.

These contactors are designed with:

- 4 main poles
- control circuit: DC operated
 - low coil consumption (3.5 W at pull-in and at holding)
 - hum-free coil
- add-on auxiliary contact blocks for front or side mounting
- designed for rail or wall mounting

Ordering details

IEC	UL/CSA	Rated control circuit voltage: U_c	Auxiliary contacts fitted	Type	Order code	Pkg qty	Weight (1 pce)
Rated operational current $\theta \leq 40^\circ\text{C}$ AC-1 A	General use rating	V DC					kg
4 N.O. main poles							
20	600 V / 16 A	24	0 0	B7D-40-00-01	GJL1317201R0001	10	0.175
		220	0 0	B7D-40-00-05	GJL1317201R0005	10	0.175
2 N.O. + 2 N.C. main poles							
20	300 V / 12 A	12	0 0	BC6-22-00-07	GJL1213501R0007	10	0.175
		24	0 0	BC6-22-00-01	GJL1213501R0001	10	0.175
		42	0 0	BC6-22-00-02	GJL1213501R0002	10	0.175
		48	0 0	BC6-22-00-16	GJL1213501R1006	10	0.175
		60	0 0	BC6-22-00-03	GJL1213501R0003	10	0.175
		110 ... 125	0 0	BC6-22-00-04	GJL1213501R0004	10	0.175
		220 ... 240	0 0	BC6-22-00-05	GJL1213501R0005	10	0.175

Other types on request

Main dimensions mm, inches

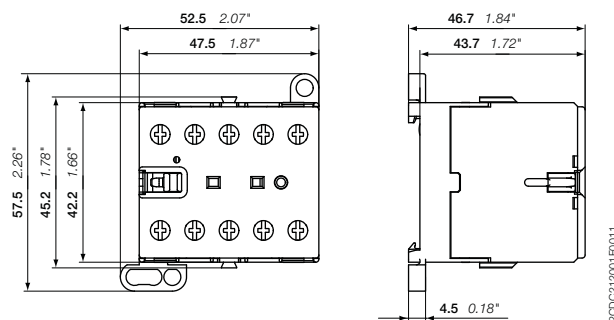

BC6, B7D

TBC7 4-pole mini contactors – with screw terminals

4 to 5.5 kW

DC operated – large coil voltage range



2CDC211028F0011

3

TBC7-31-00

Description

TBC7 4-pole mini contactors are compact control products mainly used for switching resistive or motor loads up to 690 V AC.

These contactors are designed with:

- 4 main poles
- control circuit: DC operated
 - low coil consumption (5 W at pull-in and at holding)
 - hum-free coil
- expanded ambient temperature range -30 ... +70 °C and wide range voltage supply
- no auxiliary contact block permitted for mounting
- designed for rail or wall mounting
- material is approved for railway applications

Ordering details

IEC	UL/CSA	Rated control circuit voltage $U_{Cmin} \dots U_{Cmax}$	Auxiliary contacts fitted	Type	Order code	Pkg qty	Weight (1 pce)
Rated operational current $\theta \leq 40^\circ\text{C}$ AC-1 A	General use rating	V DC					kg
3 N.O. + 1 N.C. main poles							
20	600 V / 16 A	50 ... 90	0 0	TBC7-31-00-55	GJL1313461R5005	10	0.185
		77 ... 143	0 0	TBC7-31-00-62	GJL1313461R6002	10	0.185
		140 ... 260	0 0	TBC7-31-00-68	GJL1313461R6008	10	0.185
2 N.O. + 2 N.C. main poles							
20	600 V / 16 A	50 ... 90	0 0	TBC7-22-00-55	GJL1313561R5005	10	0.185
		77 ... 143	0 0	TBC7-22-00-62	GJL1313561R6002	10	0.185
		140 ... 260	0 0	TBC7-22-00-68	GJL1313561R6008	10	0.185

Other types on request

Main dimensions mm, inches

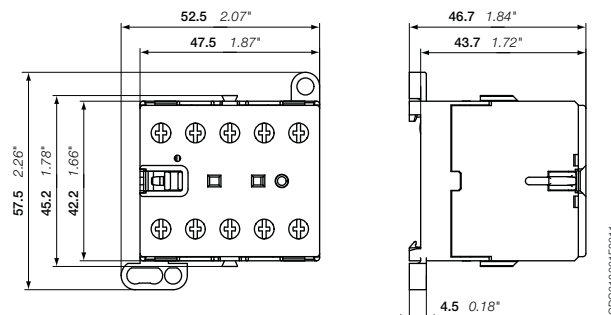

TBC7

2CDC212001F0011

2CDC102022C0201

K6 4-pole mini contactor relays – with screw terminals AC operated



K6-22Z



K6-31Z

Description

K6 4-pole mini-contactor relays are space optimized control products mainly used for control functions or for small loads up to 4 A.

These contactors are designed with:

- 4-poles with various contact combinations
- control circuit: AC operated
 - low coil consumption (3.5 VA at pull-in and at holding)
 - hum-free coil
- add-on auxiliary contact blocks for front or side mounting
- designed for rail or wall mounting

Ordering details

Rated control circuit voltage U_c		Type	Order code	Pkg qty	Weight (1 pce)
50 Hz V AC	60 Hz V AC				kg
K6 4-pole mini contactor relays					
24	24	K6-22Z-01	GJH1211001R0221	10	0.175
42	42	K6-22Z-02	GJH1211001R0222	10	0.175
48	48	K6-22Z-03	GJH1211001R0223	10	0.175
110 ... 127	110 ... 127	K6-22Z-84	GJH1211001R8224	10	0.175
220 ... 240	220 ... 240	K6-22Z-80	GJH1211001R8220	10	0.175
380 ... 415	380 ... 415	K6-22Z-85	GJH1211001R8225	10	0.175
24	24	K6-31Z-01	GJH1211001R0311	10	0.175
42	42	K6-31Z-02	GJH1211001R0312	10	0.175
48	48	K6-31Z-03	GJH1211001R0313	10	0.175
110 ... 127	110 ... 127	K6-31Z-84	GJH1211001R8314	10	0.175
220 ... 240	220 ... 240	K6-31Z-80	GJH1211001R8310	10	0.175
380 ... 415	380 ... 415	K6-31Z-85	GJH1211001R8315	10	0.175
24	24	K6-40E-01	GJH1211001R0401	10	0.175
42	42	K6-40E-02	GJH1211001R0402	10	0.175
48	48	K6-40E-03	GJH1211001R0403	10	0.175
110 ... 127	110 ... 127	K6-40E-84	GJH1211001R8404	10	0.175
220 ... 240	220 ... 240	K6-40E-80	GJH1211001R8400	10	0.175
380 ... 415	380 ... 415	K6-40E-85	GJH1211001R8405	10	0.175

Other types on request

Main dimensions mm, inches

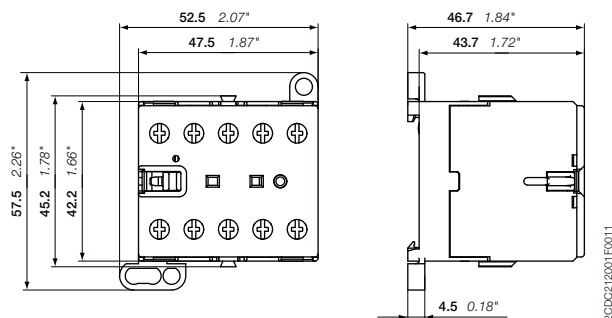

K6

KC6 4-pole mini contactor relays – with screw terminals DC operated



2CDC21101R00011

3

KC6-22Z

Description

KC6 4-pole mini-contactor relays are space optimized control products mainly used for control functions or for small loads up to 4 A.

These contactors are designed with:

- 4-poles with various contact combinations
- control circuit: DC operated
 - low coil consumption (3.5 W at pull-in and at holding)
- hum-free coil
- add-on auxiliary contact blocks for front or side mounting
- designed for rail or wall mounting

Ordering details

Rated control circuit voltage U_c V DC	Type	Order code	Pkg qty	Weight (1 pce) kg
KC6 4-pole mini contactor relays				
12	KC6-22Z-07	GJH1213001R0227	10	0.175
24	KC6-22Z-01	GJH1213001R0221	10	0.175
48	KC6-22Z-16	GJH1213001R1226	10	0.175
60	KC6-22Z-03	GJH1213001R0223	10	0.175
110 ... 125	KC6-22Z-04	GJH1213001R0224	10	0.175
220 ... 240	KC6-22Z-05	GJH1213001R0225	10	0.175
12	KC6-31Z-07	GJH1213001R0317	10	0.175
24	KC6-31Z-01	GJH1213001R0311	10	0.175
48	KC6-31Z-16	GJH1213001R1316	10	0.175
60	KC6-31Z-03	GJH1213001R0313	10	0.175
110 ... 125	KC6-31Z-04	GJH1213001R0314	10	0.175
220 ... 240	KC6-31Z-05	GJH1213001R0315	10	0.175
12	KC6-40E-07	GJH1213001R0407	10	0.175
24	KC6-40E-01	GJH1213001R0401	10	0.175
48	KC6-40E-16	GJH1213001R1406	10	0.175
60	KC6-40E-03	GJH1213001R0403	10	0.175
110 ... 125	KC6-40E-04	GJH1213001R0404	10	0.175
220 ... 240	KC6-40E-05	GJH1213001R0405	10	0.175

Other types on request

Main dimensions mm, inches

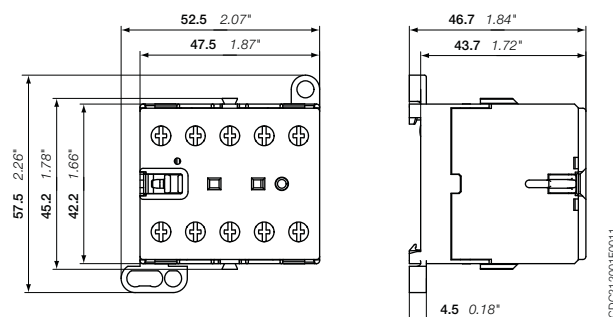

KC6

2CDC211001R00011

2CDC102012C0201

KC6 4-pole interface mini contactor relays – with screw terminals DC operated



KC6-31Z

Description

KC6 4-pole interface mini-contactor relays are space optimized control products mainly used for control functions or for small loads up to 4 A.

These contactors are designed with:

- 4-poles with various contact combinations
- control circuit: DC operated
 - low coil consumption (1.4 ... 2.8 W at pull-in and at holding)
- hum-free coil
- no auxiliary contact block permitted for mounting
- designed for rail or wall mounting

Ordering details

Rated control circuit voltage U_c V DC	Type	Order code	Pkg qty	Weight (1 pce) kg
DC operation 24 V / 1.4 W				
24	KC6-31Z-1.4-81	GJH1213001R8311	10	0.175
24	KC6-40E-1.4-81	GJH1213001R8401	10	0.175
DC operation 17 ... 32 V / 2.4 W				
17 ... 32	KC6-31Z-2.4-51	GJH1213001R5311	10	0.175
17 ... 32	KC6-40E-2.4-51	GJH1213001R5401	10	0.175
DC operation 24 V / 1.7 W				
24	K6S-22Z-1.7-71	GJH1213001R7221	10	0.175
24	K6S-31Z-1.7-71	GJH1213001R7311	10	0.175
24	K6S-40E-1.7-71	GJH1213001R7401	10	0.175
DC operation 17 ... 32 V / 2.8 W				
17 ... 32	K6S-22Z-2.8-72	GJH1213001R7222	10	0.175
17 ... 32	K6S-31Z-2.8-72	GJH1213001R7312	10	0.175
17 ... 32	K6S-40E-2.8-72	GJH1213001R7402	10	0.175

Other types on request

Main dimensions mm, inches

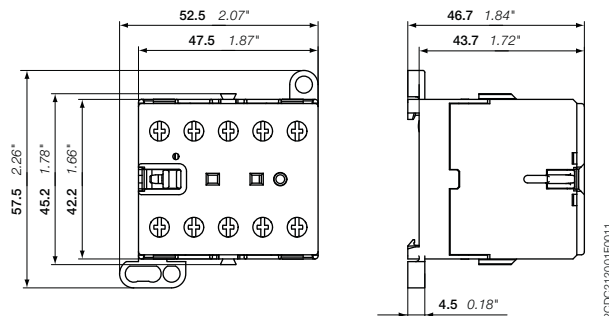

KC6

TKC6 4-pole mini contactor relays – with screw terminals

DC operated – large coil voltage range



2CDC211021F0011

3

TKC6-31Z

Description

TKC6 4-pole mini contactors are space optimized control products mainly used for control functions or for small loads up to 4 A.

These contactors are designed with:

- 4-poles with various contact combinations
- control circuit: DC operated, hum free, low consumption (5 W at pull-in and at holding)
- expanded ambient temperature range -30 ... +70 °C and wide range voltage supply
- material is suitable for railway applications
- humfree operating DC coil
- no auxiliary contact block permitted for mounting
- designed for rail or wall mounting

Ordering details

Rated control circuit voltage $U_{C \min} \dots U_{C \max}$ V DC	Type	Order code	Pkg qty	Weight (1 pce) kg
17 ... 32	TKC6-22Z-51	GJH1213061R5221	10	0.180
50 ... 90	TKC6-22Z-55	GJH1213061R5225	10	0.180
77 ... 143	TKC6-22Z-62	GJH1213061R6222	10	0.180
140 ... 260	TKC6-22Z-68	GJH1213061R6228	10	0.180
17 ... 32	TKC6-31Z-51	GJH1213061R5311	10	0.180
50 ... 90	TKC6-31Z-55	GJH1213061R5315	10	0.180
77 ... 143	TKC6-31Z-62	GJH1213061R6312	10	0.180
140 ... 260	TKC6-31Z-68	GJH1213061R6318	10	0.180
17 ... 32	TKC6-40E-51	GJH1213061R5401	10	0.180
50 ... 90	TKC6-40E-55	GJH1213061R5405	10	0.180
77 ... 143	TKC6-40E-62	GJH1213061R6402	10	0.180
140 ... 260	TKC6-40E-68	GJH1213061R6408	10	0.180

Other types on request

Main dimensions mm, inches

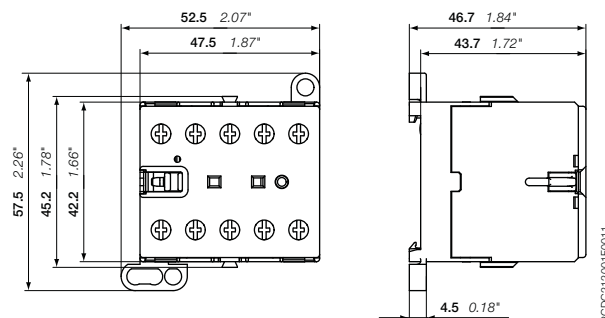

TKC6

2CDC212001F0011

2CDC102014C0201

B6, B7 3-pole mini contactors – with soldering pins

4 to 5.5 kW

AC operated



2CDC211035F0010

B6-30-10-P



2CDC211011F0011

B7-30-10-P

Description

B6..P and B7..P 3-pole mini contactors are compact control products mainly used for switching resistive or motor loads up to 690 V AC.

These contactors are designed with:

- 3 main poles and one built-in auxiliary contact
- control circuit: AC operated
 - low coil consumption (3.5 VA at pull-in and at holding)
- hum-free coil
- add-on auxiliary contact blocks for side mounting
- designed for soldering on PCB boards

Ordering details

IEC		UL/CSA		Rated control circuit voltage U_c		Auxiliary contacts fitted	Type	Order code	Pkg qty	Weight (1 pce)
Rated operational power	current $\theta \leq 40^\circ\text{C}$	3-phase motor rating	General use rating	50 Hz	60 Hz					kg
400 V AC-3 kW	AC-1 A	480 V hp		V AC	V AC					

B6 mini contactors

4	12	3	300 V / 12 A	24	24	1 0	B6-30-10-P-01	GJL1211009R0101	10	0.170
						0 1	B6-30-01-P-01	GJL1211009R0011	10	0.170
				42	42	1 0	B6-30-10-P-02	GJL1211009R0102	10	0.170
						0 1	B6-30-01-P-02	GJL1211009R0012	10	0.170
				48	48	1 0	B6-30-10-P-03	GJL1211009R0103	10	0.170
						0 1	B6-30-01-P-03	GJL1211009R0013	10	0.170
				110 ... 127	110 ... 127	1 0	B6-30-10-P-84	GJL1211009R8104	10	0.170
						0 1	B6-30-01-P-84	GJL1211009R8014	10	0.170
220 ... 240	220 ... 240			220 ... 240	220 ... 240	1 0	B6-30-10-P-80	GJL1211009R8100	10	0.170
						0 1	B6-30-01-P-80	GJL1211009R8010	10	0.170
				380 ... 415	380 ... 415	1 0	B6-30-10-P-85	GJL1211009R8105	10	0.170
						0 1	B6-30-01-P-85	GJL1211009R8015	10	0.170

B7 mini contactors

5.5	12	5	600 V / 16 A	24	24	1 0	B7-30-10-P-01	GJL1311009R0101	10	0.170
						0 1	B7-30-01-P-01	GJL1311009R0011	10	0.170
				42	42	1 0	B7-30-10-P-02	GJL1311009R0102	10	0.170
						0 1	B7-30-01-P-02	GJL1311009R0012	10	0.170
				48	48	1 0	B7-30-10-P-03	GJL1311009R0103	10	0.170
						0 1	B7-30-01-P-03	GJL1311009R0013	10	0.170
				110 ... 127	110 ... 127	1 0	B7-30-10-P-84	GJL1311009R8104	10	0.170
						0 1	B7-30-01-P-84	GJL1311009R8014	10	0.170
220 ... 240	220 ... 240			220 ... 240	220 ... 240	1 0	B7-30-10-P-80	GJL1311009R8100	10	0.170
						0 1	B7-30-01-P-80	GJL1311009R8010	10	0.170
				380 ... 415	380 ... 415	1 0	B7-30-10-P-85	GJL1311009R8105	10	0.170
						0 1	B7-30-01-P-85	GJL1311009R8015	10	0.170

Other types on request

Main dimensions mm, inches

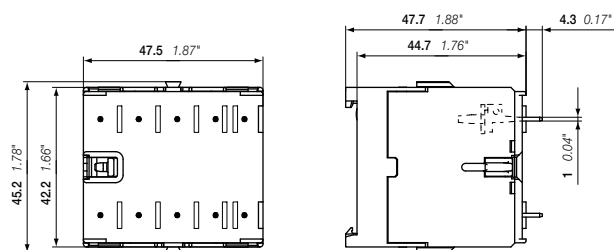

B6, B7

2CDC212003F0011

2CDC102023C0201

BC6, BC7 3-pole mini contactors – with soldering pins

4 to 5.5 kW

DC operated



2CDC211030F0011

BC7-30-10-P

3

Description

BC6, BC7 3-pole mini contactors are compact control products mainly used for switching resistive or motor loads up to 690 V AC.

These contactors are designed with:

- 3 main poles and one built-in auxiliary contact
- control circuit: DC operated
 - low coil consumption (3.5 W at pull-in and at holding)
- hum-free coil
- add-on auxiliary contact blocks for side mounting
- designed for soldering on PCB boards

Ordering details

IEC	UL/CSA	Rated control circuit voltage U_c	Auxiliary contacts fitted	Type	Order code	Pkg qty	Weight (1 pce)
Rated operational power 400 V AC-3 kW	3-phase motor rating 480 V hp	General use rating V DC					kg
current $I_n \leq 40^\circ\text{C}$ AC-1 A							

BC6 mini contactors with 3 N.O. main poles

Rated operational power	Rated operational current I_n	3-phase motor rating	General use rating	Rated control circuit voltage U_c	Auxiliary contacts fitted	Type	Order code	Pkg qty	Weight (1 pce)
4 kW	12 A	3 hp	300 V / 12 A	12 V DC	1 0	BC6-30-10-P-07	GJL1213009R0107	10	0.170
					0 1	BC6-30-01-P-07	GJL1213009R0017	10	0.170
					1 0	BC6-30-10-P-01	GJL1213009R0101	10	0.170
					0 1	BC6-30-01-P-01	GJL1213009R0011	10	0.170
					1 0	BC6-30-10-P-16	GJL1213009R1106	10	0.170
					0 1	BC6-30-01-P-16	GJL1213009R1016	10	0.170
					1 0	BC6-30-10-P-03	GJL1213009R0103	10	0.170
					0 1	BC6-30-01-P-03	GJL1213009R0013	10	0.170
					1 0	BC6-30-10-P-04	GJL1213009R0104	10	0.170
					0 1	BC6-30-01-P-04	GJL1213009R0014	10	0.170
					1 0	BC6-30-10-P-05	GJL1213009R0105	10	0.170
					0 1	BC6-30-01-P-05	GJL1213009R0015	10	0.170

BC7 mini contactors with 3 N.O. main poles

Rated operational power	Rated operational current I_n	3-phase motor rating	General use rating	Rated control circuit voltage U_c	Auxiliary contacts fitted	Type	Order code	Pkg qty	Weight (1 pce)
5.5 kW	12 A	5 hp	600 V / 16 A	12 V DC	1 0	BC7-30-10-P-07	GJL1313009R0107	10	0.170
					0 1	BC7-30-01-P-07	GJL1313009R0017	10	0.170
					1 0	BC7-30-10-P-01	GJL1313009R0101	10	0.170
					0 1	BC7-30-01-P-01	GJL1313009R0011	10	0.170
					1 0	BC7-30-10-P-16	GJL1313009R1106	10	0.170
					0 1	BC7-30-01-P-16	GJL1313009R1016	10	0.170
					1 0	BC7-30-10-P-03	GJL1313009R0103	10	0.170
					0 1	BC7-30-01-P-03	GJL1313009R0013	10	0.170
					1 0	BC7-30-10-P-04	GJL1313009R0104	10	0.170
					0 1	BC7-30-01-P-04	GJL1313009R0014	10	0.170
					1 0	BC7-30-10-P-05	GJL1313009R0105	10	0.170
					0 1	BC7-30-01-P-05	GJL1313009R0015	10	0.170

BC6 mini contactors 2 N.O. + 1 N.C. main poles

Rated operational power	Rated operational current I_n	3-phase motor rating	General use rating	Rated control circuit voltage U_c	Auxiliary contacts fitted	Type	Order code	Pkg qty	Weight (1 pce)
4 kW	12 A	3 hp	300 V / 12 A	24 V DC	1 0	BC6-21-10-P-01	GJL1213109R0101	10	0.170
					1 0	BC6-21-10-P-16	GJL1213109R1106	10	0.170
					1 0	BC6-21-10-P-03	GJL1213109R0103	10	0.170
					1 0	BC6-21-10-P-04	GJL1213109R0104	10	0.170
					1 0	BC6-21-10-P-05	GJL1213109R0105	10	0.170

Other types on request

Main dimensions mm, inches

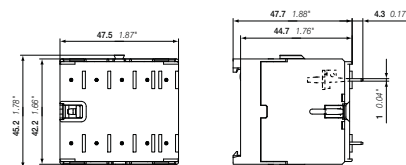

B6, B7

2CDC212030F0011

2CDC102024C0201

VB6, VB7 3-pole mini reversing contactors – with soldering pins 4 to 5.5 kW AC operated



VB7-30-10-P

2CDC211016S0011

Description

VB6, VB7 3-pole compact design reversing contactors are space optimized control products mainly used for switching resistive or motor loads up to 690 V AC.

These reversing contactors are designed with:

- built-in mechanical interlock. The coils must be mutually interlocked electrically and coils must be de-energised for 50 ms at least to prevent phase to phase short circuit on the arc
- control circuit: AC operated
 - low coil consumption (3.5 VA at pull-in and at holding)
- hum-free coil
- no auxiliary contact block permitted for mounting
- designed for soldering on PCB boards

Ordering details

IEC Rated power 400 V AC-3 kW	operational current $\theta \leq 40^\circ\text{C}$ AC-1 A	UL/CSA 3-phase motor rating 480 V hp	General use rating	Rated control circuit voltage U_c		Auxiliary contacts fitted 	Type	Order code	Pkg qty	Weight (1 pce) kg
				50 Hz V AC	60 Hz V AC					

VB6 mini reversing contactors

4	12	3	300 V / 12 A	24	24	1 0	VB6-30-10-P-01	GJL1211909R0101	5	0.345
						0 1	VB6-30-01-P-01	GJL1211909R0011	5	0.345
				42	42	1 0	VB6-30-10-P-02	GJL1211909R0102	5	0.345
						0 1	VB6-30-01-P-02	GJL1211909R0012	5	0.345
				48	48	1 0	VB6-30-10-P-03	GJL1211909R0103	5	0.345
						0 1	VB6-30-01-P-03	GJL1211909R0013	5	0.345
				110 ... 127	110 ... 127	1 0	VB6-30-10-P-84	GJL1211909R8104	5	0.345
						0 1	VB6-30-01-P-84	GJL1211909R8014	5	0.345
				220 ... 240	220 ... 240	1 0	VB6-30-10-P-80	GJL1211909R8100	5	0.345
						0 1	VB6-30-01-P-80	GJL1211909R8010	5	0.345
				380 ... 415	380 ... 415	1 0	VB6-30-10-P-85	GJL1211909R8105	5	0.345
						0 1	VB6-30-01-P-85	GJL1211909R8015	5	0.345

VB7 mini reversing contactors

5.5	12	5	600 V / 16 A	24	24	1 0	VB7-30-10-P-01	GJL1311909R0101	5	0.345
						0 1	VB7-30-01-P-01	GJL1311909R0011	5	0.345
				42	42	1 0	VB7-30-10-P-02	GJL1311909R0102	5	0.345
						0 1	VB7-30-01-P-02	GJL1311909R0012	5	0.345
				48	48	1 0	VB7-30-10-P-03	GJL1311909R0103	5	0.345
						0 1	VB7-30-01-P-03	GJL1311909R0013	5	0.345
				110 ... 127	110 ... 127	1 0	VB7-30-10-P-84	GJL1311909R8104	5	0.345
						0 1	VB7-30-01-P-84	GJL1311909R8014	5	0.345
				220 ... 240	220 ... 240	1 0	VB7-30-10-P-80	GJL1311909R8100	5	0.345
						0 1	VB7-30-01-P-80	GJL1311909R8010	5	0.345
				380 ... 415	380 ... 415	1 0	VB7-30-10-P-85	GJL1311909R8105	5	0.345
						0 1	VB7-30-01-P-85	GJL1311909R8015	5	0.345

Other types on request

Main dimensions mm, inches

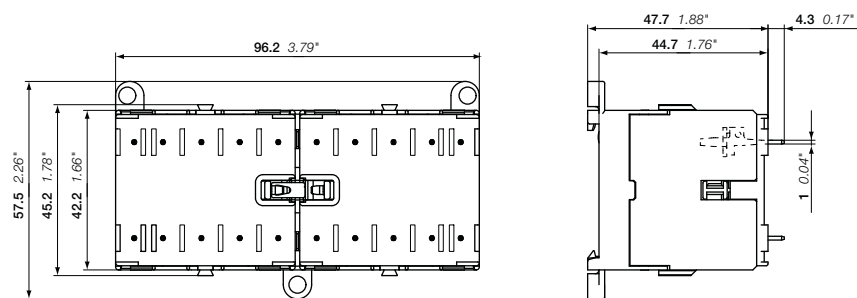

VB6, VB7

2CDC212007F0011

2CDC102025C0201

VBC6, VBC7 3-pole mini reversing contactors – with soldering pins

4 to 5.5 kW

DC operated



2CDC211009R0011

3

VBC7-30-10-P

Description

VBC6, VBC7 3-pole compact design reversing contactors are space optimized control products mainly used for switching resistive or motor loads up to 690 V AC.

These reversing contactors are designed with:

- built-in mechanical interlock. The coils must be mutually interlocked electrically and coils must be de-energised for 50 ms at least to prevent phase to phase short circuit on the arc
- control circuit: DC operated
 - low coil consumption (3.5 W at pull-in and at holding)
- hum-free coil
- no auxiliary contact block permitted for mounting
- designed for soldering on PCB boards

Ordering details

IEC		UL/CSA		Rated control circuit voltage U_c	Auxiliary contacts fitted	Type	Order code	Pkg qty	Weight (1 pce)					
Rated operational power	operational current $\theta \leq 40^\circ\text{C}$	3-phase motor rating	General use rating											
400 V AC-3	AC-1	480 V		V DC					kg					
VBC6 mini reversing contactors														
4	12	3	300 V / 12 A	12	1 0	VBC6-30-10-P-07	GJL1213909R0107	5	0.345					
					0 1	VBC6-30-01-P-07	GJL1213909R0017	5	0.345					
				24	1 0	VBC6-30-10-P-01	GJL1213909R0101	5	0.345					
					0 1	VBC6-30-01-P-01	GJL1213909R0011	5	0.345					
				48	1 0	VBC6-30-10-P-06	GJL1213909R0106	5	0.345					
					0 1	VBC6-30-06-P-06	GJL1213909R0016	5	0.345					
				60	1 0	VBC6-30-10-P-03	GJL1213909R0103	5	0.345					
					0 1	VBC6-30-01-P-03	GJL1213909R0013	5	0.345					
				110 ... 125	1 0	VBC6-30-10-P-04	GJL1213909R0104	5	0.345					
					0 1	VBC6-30-01-P-04	GJL1213909R0014	5	0.345					
				220 ... 240	1 0	VBC6-30-10-P-05	GJL1213909R0105	5	0.345					
					0 1	VBC6-30-01-P-05	GJL1213909R0015	5	0.345					
				VBC7 mini reversing contactors										
				5.5	12	5	600 V / 16 A	12	1 0	VBC7-30-10-P-07	GJL1313909R0107	5	0.345	
0 1	VBC7-30-01-P-07	GJL1313909R0017	5						0.345					
24	1 0	VBC7-30-10-P-01	GJL1313909R0101					5	0.345					
	0 1	VBC7-30-01-P-01	GJL1313909R0011					5	0.345					
48	1 0	VBC7-30-10-P-16	GJL1313909R1106					5	0.345					
	0 1	VBC7-30-01-P-16	GJL1313909R1016					5	0.345					
60	1 0	VBC7-30-10-P-03	GJL1313909R0103					5	0.345					
	0 1	VBC7-30-01-P-03	GJL1313909R0013					5	0.345					
110 ... 125	1 0	VBC7-30-10-P-04	GJL1313909R0104					5	0.345					
	0 1	VBC7-30-01-P-04	GJL1313909R0014					5	0.345					
220 ... 240	1 0	VBC7-30-10-P-05	GJL1313909R0105					5	0.345					
	0 1	VBC7-30-01-P-05	GJL1313909R0015					5	0.345					

Other types on request

Main dimensions mm, inches

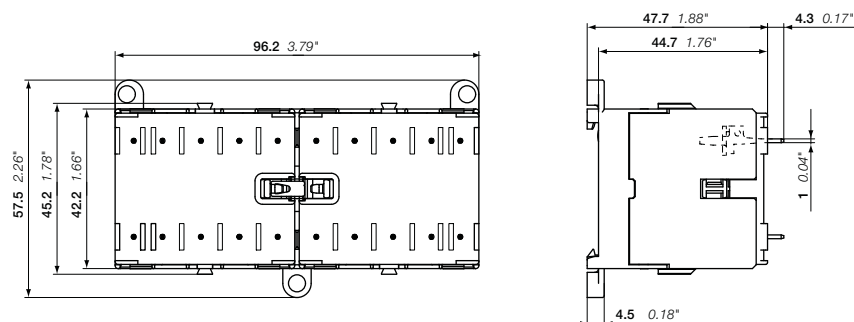

VBC6, VBC7

2CDC212007R0011

2CDC102026C0201

VB6A, VB7A 3-pole mini reversing contactors – with soldering pins 4 to 5.5 kW AC operated – with safety blocking function



VB7-30-01-P

2CDC211019R0010

Description

VB6A, VB7A 3-pole compact design reversing contactors are space optimized control products mainly used for switching resistive or motor loads up to 690 V AC.

These reversing contactors are designed with:

- built-in mechanical interlock and safety blocking function. The safety blocking function is triggered if the voltage is applied to the coil of the contactor to be switched on before the contactor to be switched off has dropped out. The contactor coils are designed for continuous operation when the contactor is de-energised i.e. the coil is not damaged if the mechanical interlock prevents switch-on of the contactor with the coil voltage applied.
- control circuit: AC operated
 - low coil consumption (3.5 VA at pull-in and at holding)
- hum-free coil
- no auxiliary contact block permitted for mounting
- designed for soldering on PCB boards

Ordering details

IEC		UL/CSA		Rated control circuit voltage U_c		Auxiliary contacts fitted	Type	Order code	Pkg qty	Weight (1 pce)
Rated operational power	current $\theta \leq 40^\circ\text{C}$	3-phase motor rating	General use rating	50 Hz	60 Hz					
400 V AC-3 kW	AC-1 A	hp	480 V	V AC	V AC					kg

VB6A mini reversing contactors with safety blocking function

4	12	3	300 V / 12 A	24	24	1 0	VB6A-30-10-P-01	GJL1211919R0101	5	0.345
						0 1	VB6A-30-01-P-01	GJL1211919R0011	5	0.345
				42	42	1 0	VB6A-30-10-P-02	GJL1211919R0102	5	0.345
						0 1	VB6A-30-01-P-02	GJL1211919R0012	5	0.345
				48	48	1 0	VB6A-30-10-P-03	GJL1211919R0103	5	0.345
						0 1	VB6A-30-01-P-03	GJL1211919R0013	5	0.345
				110 ... 127	110 ... 127	1 0	VB6A-30-10-P-84	GJL1211919R8104	5	0.345
						0 1	VB6A-30-01-P-84	GJL1211919R8014	5	0.345
220 ... 240	220 ... 240			220 ... 240	220 ... 240	1 0	VB6A-30-10-P-80	GJL1211919R8100	5	0.345
						0 1	VB6A-30-01-P-80	GJL1211919R8010	5	0.345
				380 ... 415	380 ... 415	1 0	VB6A-30-10-P-85	GJL1211919R8105	5	0.345
						0 1	VB6A-30-01-P-85	GJL1211919R8015	5	0.345

VB7A mini reversing contactors with safety blocking function

5.5	12	5	600 V / 16 A	24	24	1 0	VB7A-30-10-P-01	GJL1311919R0101	5	0.345
						0 1	VB7A-30-01-P-01	GJL1311919R0011	5	0.345
				42	42	1 0	VB7A-30-10-P-02	GJL1311919R0102	5	0.345
						0 1	VB7A-30-01-P-02	GJL1311919R0012	5	0.345
				48	48	1 0	VB7A-30-10-P-03	GJL1311919R0103	5	0.345
						0 1	VB7A-30-01-P-03	GJL1311919R0013	5	0.345
				110 ... 127	110 ... 127	1 0	VB7A-30-10-P-84	GJL1311919R8104	5	0.345
						0 1	VB7A-30-01-P-84	GJL1311919R8014	5	0.345
220 ... 240	220 ... 240			220 ... 240	220 ... 240	1 0	VB7A-30-10-P-80	GJL1311919R8100	5	0.345
						0 1	VB7A-30-01-P-80	GJL1311919R8010	5	0.345
				380 ... 415	380 ... 415	1 0	VB7A-30-10-P-85	GJL1311919R8105	5	0.345
						0 1	VB7A-30-01-P-85	GJL1311919R8015	5	0.345

Other types on request

Main dimensions mm, inches

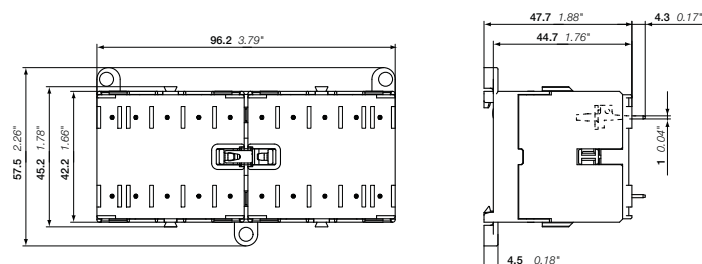

VB6A, VB7A

2CDC210007F0011

2CDC102027C0201

VBC7A 3-pole mini reversing contactors – with soldering pins

4 to 5.5 kW

DC operated – with safety blocking function



2CDC211009F0011

3

VBC7A-30-10-P

Description

VBC7A 3-pole compact design reversing contactors are space optimized control products mainly used for switching resistive or motor loads up to 690 V AC.

These reversing contactors are designed with:

- built-in mechanical interlock and safety blocking function. The safety blocking function is triggered if the voltage is applied to the coil of the contactor to be switched on before the contactor to be switched off has dropped out. The contactor coils are designed for continuous operation when the contactor is de-energised i.e. the coil is not damaged if the mechanical interlock prevents switch-on of the contactor with the coil voltage applied.
- control circuit: AC operated
 - low coil consumption (3.5 W at pull-in and at holding)
 - hum-free coil
- no auxiliary contact block permitted for mounting
- designed for soldering on PCB boards

Ordering details

IEC		UL/CSA		Rated control circuit voltage U_c	Auxiliary contacts fitted	Type	Order code	Pkg qty	Weight (1 pce)
Rated operational power	current $\leq 40^\circ\text{C}$	3-phase motor rating	General use rating						
400 V	AC-3	AC-1		V DC					kg
kW	A	hp							

VBC7A mini reversing contactors with safety blocking function

Rated power (kW)	Rated current (A)	Motor rating (hp)	Rated voltage (V)	Rated current (A)	Control voltage (V DC)	Control current (A)	Order code	Order code	Pkg qty	Weight (kg)		
5.5	12	5	600 V / 16 A	12	12	1 0	VBC7A-30-10-P-07	GJL1313919R0107	5	0.345		
						0 1	VBC7A-30-01-P-07	GJL1313919R0017	5	0.345		
				24	24	1 0	VBC7A-30-10-P-01	GJL1313919R0101	5	0.345		
						0 1	VBC7A-30-01-P-01	GJL1313919R0011	5	0.345		
				48	48	48	1 0	VBC7A-30-10-P-16	GJL1313919R1106	5	0.345	
							0 1	VBC7A-30-01-P-16	GJL1313919R1016	5	0.345	
				60	60	60	60	1 0	VBC7A-30-10-P-03	GJL1313919R0103	5	0.345
								0 1	VBC7A-30-01-P-03	GJL1313919R0013	5	0.345
				110 ... 125	110 ... 125	110 ... 125	110 ... 125	1 0	VBC7A-30-10-P-04	GJL1313919R0104	5	0.345
								0 1	VBC7A-30-01-P-04	GJL1313919R0014	5	0.345
				220 ... 240	220 ... 240	220 ... 240	220 ... 240	1 0	VBC7A-30-10-P-05	GJL1313919R0105	5	0.345
								0 1	VBC7A-30-01-P-05	GJL1313919R0015	5	0.345

Other types on request

Main dimensions mm, inches

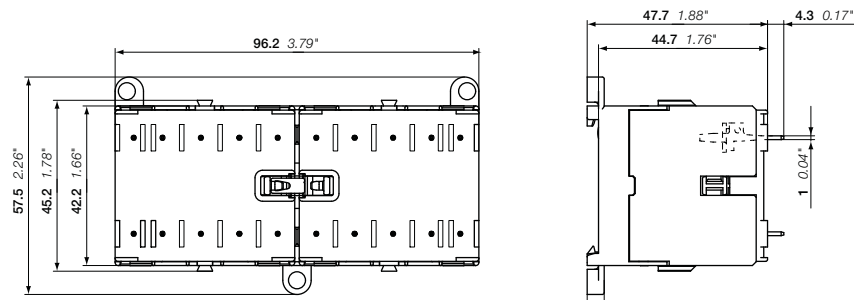

VBC7A

2CDC212007F0011

2CDC102028C0201

K6 4-pole mini contactor relays – with soldering pins AC operated



2CDC1102ZF0011

K6-22Z-P

Description

K6 4-pole mini-contactor relays are space optimized control products mainly used for control functions or for small loads up to 4 A.

These contactors are designed with:

- 4-poles with various contact combinations
- control circuit: AC operated
 - low coil consumption (3.5 VA at pull-in and at holding)
- hum-free coil
- add-on auxiliary contact block for side mounting
- designed for soldering on PCB boards

Ordering details

Rated control circuit voltage U_c		Type	Order code	Pkg qty	Weight (1 pce) kg
50 Hz V AC	60 Hz V AC				
K6 4-pole mini contactor relays					
24	24	K6-22Z-P-01	GJH1211009R0221	10	0.170
42	42	K6-22Z-P-02	GJH1211009R0222	10	0.170
48	48	K6-22Z-P-03	GJH1211009R0223	10	0.170
110 ... 127	110 ... 127	K6-22Z-P-84	GJH1211009R8224	10	0.170
220 ... 240	220 ... 240	K6-22Z-P-80	GJH1211009R8220	10	0.170
380 ... 415	380 ... 415	K6-22Z-P-85	GJH1211009R8225	10	0.170
24	24	K6-31Z-P-01	GJH1211009R0311	10	0.170
42	42	K6-31Z-P-02	GJH1211009R0312	10	0.170
48	48	K6-31Z-P-03	GJH1211009R0313	10	0.170
110 ... 127	110 ... 127	K6-31Z-P-84	GJH1211009R8314	10	0.170
220 ... 240	220 ... 240	K6-31Z-P-80	GJH1211009R8310	10	0.170
380 ... 415	380 ... 415	K6-31Z-P-85	GJH1211009R8315	10	0.170
24	24	K6-40E-P-01	GJH1211009R0401	10	0.170
42	42	K6-40E-P-02	GJH1211009R0402	10	0.170
48	48	K6-40E-P-03	GJH1211009R0403	10	0.170
110 ... 127	110 ... 127	K6-40E-P-84	GJH1211009R8404	10	0.170
220 ... 240	220 ... 240	K6-40E-P-80	GJH1211009R8400	10	0.170
380 ... 415	380 ... 415	K6-40E-P-85	GJH1211009R8405	10	0.170

Other types on request

Main dimensions mm, inches

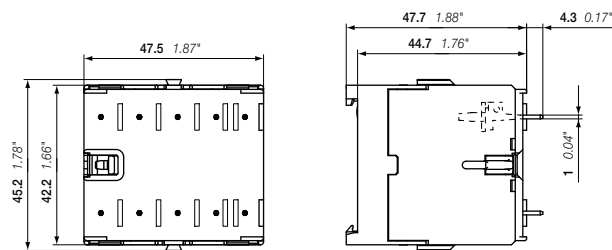

K6

2CDC12030F0011

2CDC102030C0201

KC6 4-pole mini contactor relays – with soldering pins DC operated



2CDC211029F0011

3

KC6-22Z-P



2CDC211029F0011

KC6-31Z-P

Description

KC6 4-pole mini-contactor relays are space optimized control products mainly used for control functions or for small loads up to 4 A.

These contactors are designed with:

- 4-poles with various contact combinations
- control circuit: DC operated
 - low coil consumption (3.5 W at pull-in and at holding)
- hum-free coil
- add-on auxiliary contact block for side mounting
- designed for soldering on PCB boards

Ordering details

Rated control circuit voltage U_c V DC	Type	Order code	Pkg qty	Weight (1 pce) kg
K6 4-pole mini contactor relays				
12	KC6-22Z-P-07	GJH1213009R0227	10	0.170
24	KC6-22Z-P-01	GJH1213009R0221	10	0.170
48	KC6-22Z-P-16	GJH1213009R1226	10	0.170
110 ... 125	KC6-22Z-P-04	GJH1213009R0224	10	0.170
220 ... 240	KC6-22Z-P-05	GJH1213009R0225	10	0.170
24	KC6-31Z-P-01	GJH1213009R0311	10	0.170
48	KC6-31Z-P-16	GJH1213009R1316	10	0.170
110 ... 125	KC6-31Z-P-04	GJH1213009R0314	10	0.170
220 ... 240	KC6-31Z-P-05	GJH1213009R0315	10	0.170
12	KC6-40E-P-07	GJH1213009R0407	10	0.170
24	KC6-40E-P-01	GJH1213009R0401	10	0.170
48	KC6-40E-P-16	GJH1213009R1406	10	0.170
110 ... 125	KC6-40E-P-04	GJH1213009R0404	10	0.170
220 ... 240	KC6-40E-P-05	GJH1213009R0405	10	0.170

Other types on request

Main dimensions mm, inches

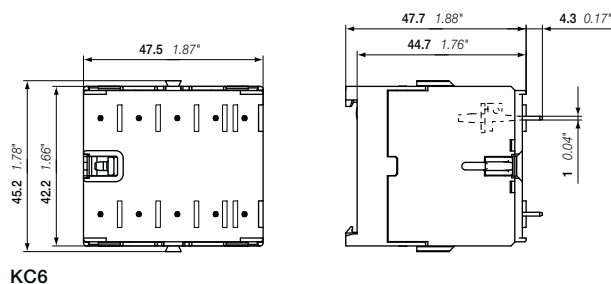

KC6

2CDC212003F0011

2CDC102031C0201

BC6, BC7 3-pole interface mini contactors – with soldering pins 4 to 5.5 kW DC operated



2CDC211039F0011

BC7-30-10-P

Description

BC6, BC7 3-pole interface mini contactors are compact control products mainly used for switching resistive or motor loads up to 690 V AC.

These contactors are designed with:

- 3 main poles and one built-in auxiliary contact
- control circuit: DC operated
 - low coil consumption (1.4 ... 2.4 W at pull-in and at holding)
- hum-free coil
- no auxiliary contact block permitted for mounting
- designed for soldering on PCB boards

Ordering details

IEC		UL/CSA		Rated control circuit voltage: U_c	Auxiliary contacts fitted	Type	Order code	Pkg qty	Weight (1 pce)
Rated operational power	current $\theta \leq 40^\circ\text{C}$	3-phase motor rating	General use rating						
400 V AC-3 kW	AC-1 A	480 V hp		V DC					kg
DC operation 24 V / 1.4 W									
4	12	3	300 V / 12 A	24	1 0 0 1	BC6-30-10-P-1.4-81 BC6-30-01-P-1.4-81	GJL1213009R8101 GJL1213009R8011	10	0.170
5.5	12	5	600 V / 16 A	24	1 0 0 1	BC7-30-10-P-1.4-81 BC7-30-01-P-1.4-81	GJL1313009R8101 GJL1313009R8011	10	0.170
DC operation 17 ... 32 V / 2.4 W, $I_m < 8$ A									
4	12	3	300 V / 12 A	17 ... 32	1 0 0 1	BC6-30-10-P-2.4-51 BC6-30-01-P-2.4-51	GJL1213009R5101 GJL1213009R5011	10	0.170
5.5	12	5	600 V / 16 A	17 ... 32	1 0 0 1	BC7-30-10-P-2.4-51 BC7-30-01-P-2.4-51	GJL1313009R5101 GJL1313009R5011	10	0.170

Other types on request

Main dimensions mm, inches

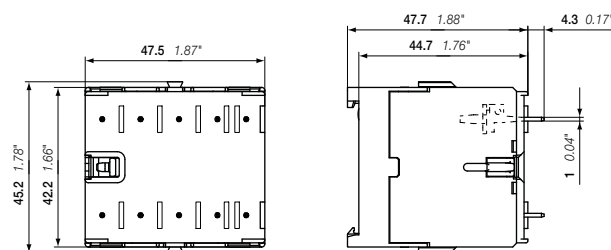

BC6, BC7

2CDC211039F0011

2CDC102029C0201

KC6 4-pole interface mini contactor relays – with solderings pins DC operated



2CDC211023F0011

KC6-31Z-P-1.4

3

Description

KC6 4-pole interface mini-contactor relays are space optimized control products mainly used for control functions or for small loads up to 4 A.

These contactors are designed with:

- 4-poles with various contact combinations
- control circuit: DC operated
 - low coil consumption (3.5 W at pull-in and at holding)
- hum-free coil
- add-on auxiliary contact block for side mounting
- designed for soldering on PCB boards

Ordering details

Rated control circuit voltage U_c V DC	Type	Order code	Pkg qty	Weight (1 pce) kg
DC operation 24 V / 1.4 W				
24	KC6-31Z-P-1.4-81	GJH1213009R8311	10	0.170
24	KC6-40E-P-1.4-81	GJH1213009R8401	10	0.170
DC operation 17 ... 32 V / 2.4 W				
17 ... 32	KC6-31Z-P-2.4-51	GJH1213009R5311	10	0.170
17 ... 32	KC6-40E-P-2.4-51	GJH1213009R5401	10	0.170

Other types on request

Main dimensions mm, inches

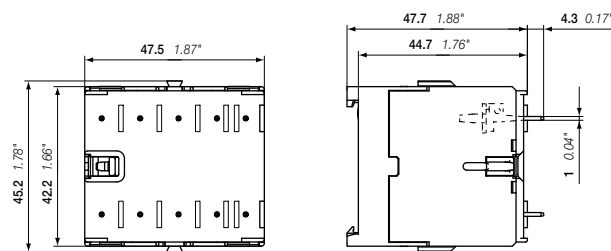

KC6

2CDC212003F0011

2CDC102032C0201

B6, B7 3-pole mini contactors – with flat pin connection

4 to 5.5 kW

AC operated



2CDC211002F0010

B6-30-10-F



2CDC211031F0011

B7-30-10-F

Description

B6..F, B7..F 3-pole mini contactors are compact control products mainly used for switching resistive or motor loads up to 690 V AC.

These contactors are designed with:

- flat pin connection for plug-in wiring and shake proven connection
- 3 main poles and one built-in auxiliary contact
- control circuit: AC operated
 - low coil consumption (3.5 VA at pull-in and at holding)
- hum-free coil
- add-on auxiliary contact blocks for side mounting
- designed for rail or wall mounting

Ordering details

IEC	Rated power	operational current $\theta \leq 40^\circ\text{C}$	UL/CSA 3-phase motor rating 480 V	General use rating	Rated control circuit voltage U_c		Auxiliary contacts fitted	Type	Order code	Pkg qty	Weight (1 pce)
					50 Hz V AC	60 Hz V AC					
400 V AC-3 kW	AC-1 A	hp									kg

B6 mini contactors

Rated power	operational current	3-phase motor rating	General use rating	50 Hz V AC	60 Hz V AC	Auxiliary contacts fitted	Type	Order code	Pkg qty	Weight (1 pce)
4	20	3	300 V / 12 A	24	24	1 0	B6-30-10-F-01	GJL1211003R0101	10	0.170
						0 1	B6-30-01-F-01	GJL1211003R0011	10	0.170
				42	42	1 0	B6-30-10-F-02	GJL1211003R0102	10	0.170
						0 1	B6-30-01-F-02	GJL1211003R0012	10	0.170
				48	48	1 0	B6-30-10-F-03	GJL1211003R0103	10	0.170
						0 1	B6-30-01-F-03	GJL1211003R0013	10	0.170
				110 ... 127	110 ... 127	1 0	B6-30-10-F-84	GJL1211003R8104	10	0.170
						0 1	B6-30-01-F-84	GJL1211003R8014	10	0.170
				220 ... 240	220 ... 240	1 0	B6-30-10-F-80	GJL1211003R8100	10	0.170
						0 1	B6-30-01-F-80	GJL1211003R8010	10	0.170
				380 ... 415	380 ... 415	1 0	B6-30-10-F-85	GJL1211003R8105	10	0.170
						0 1	B6-30-01-F-85	GJL1211003R8015	10	0.170

B7 mini contactors

Rated power	operational current	3-phase motor rating	General use rating	50 Hz V AC	60 Hz V AC	Auxiliary contacts fitted	Type	Order code	Pkg qty	Weight (1 pce)
5.5	20	5	600 V / 16 A	24	24	1 0	B7-30-10-F-01	GJL1311003R0101	10	0.170
						0 1	B7-30-01-F-01	GJL1311003R0011	10	0.170
				42	42	1 0	B7-30-10-F-02	GJL1311003R0102	10	0.170
						0 1	B7-30-01-F-02	GJL1311003R0012	10	0.170
				48	48	1 0	B7-30-10-F-03	GJL1311003R0103	10	0.170
						0 1	B7-30-01-F-03	GJL1311003R0013	10	0.170
				110 ... 127	110 ... 127	1 0	B7-30-10-F-84	GJL1311003R8104	10	0.170
						0 1	B7-30-01-F-84	GJL1311003R8014	10	0.170
				220 ... 240	220 ... 240	1 0	B7-30-10-F-80	GJL1311003R8100	10	0.170
						0 1	B7-30-01-F-80	GJL1311003R8010	10	0.170
				380 ... 415	380 ... 415	1 0	B7-30-10-F-85	GJL1311003R8105	10	0.170
						0 1	B7-30-01-F-85	GJL1311003R8015	10	0.170

Other types on request

Main dimensions mm, inches

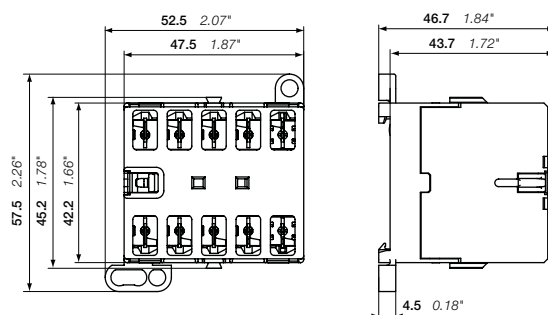

B6, B7

2CDC212002F0011

2CDC1020300201

BC6, BC7 3-pole mini contactors – with flat pin connection

4 to 5.5 kW

DC operated



2CDC211041F0011

BC6-30-10-F



2CDC211024F0011

BC7-30-10-F

Description

BC6, BC7 3-pole mini contactors are compact control products mainly used for switching resistive or motor loads up to 690 V AC.

These contactors are designed with:

- flat pin connection for plug-in wiring and shake proven connection
- 3 main poles and one built-in auxiliary contact
- control circuit: DC operated
 - low coil consumption (3.5 W at pull-in and at holding)
- hum-free coil
- add-on auxiliary contact blocks for side mounting
- designed for rail or wall mounting

Ordering details

IEC	UL/CSA	Rated control circuit voltage U_c	Auxiliary contacts fitted	Type	Order code	Pkg qty	Weight (1 pce)
Rated operational power 400 V AC-3 kW	3-phase motor rating 480 V hp	General use rating V DC					kg

BC6 mini contactors

4	20	3	300 V / 12 A	12	1 0	BC6-30-10-F-07	GJL1213003R0107	10	0.170
					0 1	BC6-30-01-F-07	GJL1213003R0017	10	0.170
				24	1 0	BC6-30-10-F-01	GJL1213003R0101	10	0.170
					0 1	BC6-30-01-F-01	GJL1213003R0011	10	0.170
				48	1 0	BC6-30-10-F-16	GJL1213003R1106	10	0.170
					0 1	BC6-30-01-F-16	GJL1213003R1016	10	0.170
				60	1 0	BC6-30-10-F-03	GJL1213003R0103	10	0.170
					0 1	BC6-30-01-F-03	GJL1213003R0013	10	0.170
				110 ... 125	1 0	BC6-30-10-F-04	GJL1213003R0104	10	0.170
					0 1	BC6-30-01-F-04	GJL1213003R0014	10	0.170
				220 ... 240	1 0	BC6-30-10-F-05	GJL1213003R0105	10	0.170
					0 1	BC6-30-01-F-05	GJL1213003R0015	10	0.170

BC7 mini contactors

5.5	20	5	600 V / 16 A	12	1 0	BC7-30-10-F-07	GJL1313003R0107	10	0.170
					0 1	BC7-30-01-F-07	GJL1313003R0017	10	0.170
				24	1 0	BC7-30-10-F-01	GJL1313003R0101	10	0.170
					0 1	BC7-30-01-F-01	GJL1313003R0011	10	0.170
				48	1 0	BC7-30-10-F-16	GJL1313003R1106	10	0.170
					0 1	BC7-30-01-F-16	GJL1313003R1016	10	0.170
				60	1 0	BC7-30-10-F-03	GJL1313003R0103	10	0.170
					0 1	BC7-30-01-F-03	GJL1313003R0013	10	0.170
				110 ... 125	1 0	BC7-30-10-F-04	GJL1313003R0104	10	0.170
					0 1	BC7-30-01-F-04	GJL1313003R0014	10	0.170
				220 ... 240	1 0	BC7-30-10-F-05	GJL1313003R0105	10	0.170
					0 1	BC7-30-01-F-05	GJL1313003R0015	10	0.170

Other types on request

Main dimensions mm, inches

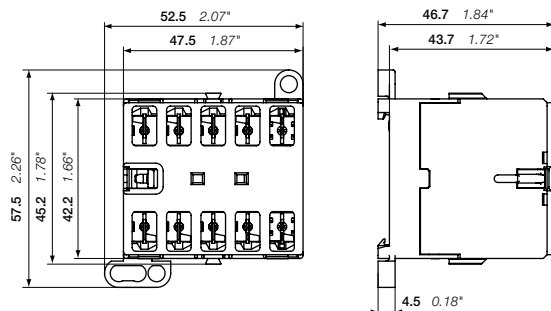

BC6, BC7

VB7 3-pole mini reversing contactors – with flat pin connection

4 to 5.5 kW

AC operated



2CDC211006F0011

VB7-30-10-F

Description

VB7 3-pole compact design reversing contactors are space optimized control products mainly used for switching resistive or motor loads up to 690 V AC.

These reversing contactors are designed with:

- built-in mechanical interlock. The coils must be mutually interlocked electrically and coils must be de-energised for 50 ms at least to prevent phase to phase short circuit on the arc.
- flat pin connection for plug-in wiring and shake proven connection
- control circuit: AC operated
 - low coil consumption (3.5 VA at pull-in and at holding)
- hum-free coil
- no auxiliary contact block permitted for mounting
- for rail and wall mounting

Ordering details

IEC Rated power 400 V AC-3 kW	operational current $\theta \leq 40^\circ\text{C}$ AC-1 A	UL/CSA 3-phase motor rating 480 V hp	General use rating	Rated control circuit voltage U_c		Auxiliary contacts fitted 	Type	Order code	Pkg qty	Weight (1 pce) kg
				50 Hz V AC	60 Hz V AC					

VB7 mini reversing contactors

5.5	20	5	600 V / 16 A	24	24	1 0	VB7-30-10-F-01	GJL1311903R0101	5	0.345
						0 1	VB7-30-01-F-01	GJL1311903R0011	5	0.345
				42	42	1 0	VB7-30-10-F-02	GJL1311903R0102	5	0.345
						0 1	VB7-30-01-F-02	GJL1311903R0012	5	0.345
				48	48	1 0	VB7-30-10-F-03	GJL1311903R0103	5	0.345
						0 1	VB7-30-01-F-03	GJL1311903R0013	5	0.345
				110 ... 127	110 ... 127	1 0	VB7-30-10-F-84	GJL1311903R8104	5	0.345
						0 1	VB7-30-01-F-84	GJL1311903R8014	5	0.345
				220 ... 240	220 ... 240	1 0	VB7-30-10-F-80	GJL1311903R8100	5	0.345
						0 1	VB7-30-01-F-80	GJL1311903R8010	5	0.345
				380 ... 415	380 ... 415	1 0	VB7-30-10-F-85	GJL1311903R8105	5	0.345
						0 1	VB7-30-01-F-85	GJL1311903R8015	5	0.345

Other types on request

Main dimensions mm, inches

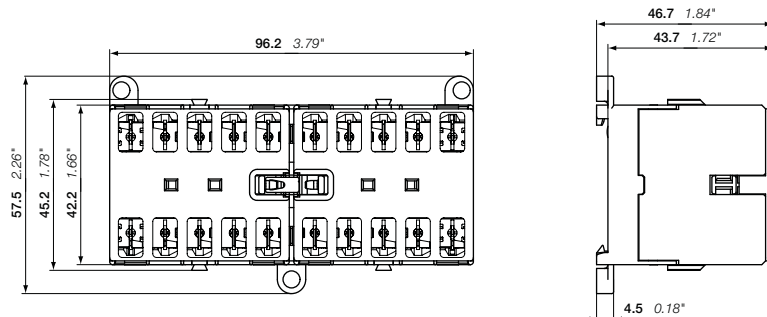

VB7

2CDC211006F0011

2CDC102035C0201

VBC7 3-pole mini reversing contactors – with flat pin connection

4 to 5.5 kW

DC operated



2CDC211004F0011

3

VBC7-30-10-F

Description

VBC7 3-pole compact design reversing contactors are space optimized control products mainly used for switching resistive or motor loads up to 690 V AC.

These reversing contactors are designed with:

- built-in mechanical interlock. The coils must be mutually interlocked electrically and coils must be de-energised for 50 ms at least to prevent phase to phase short circuit on the arc
- flat pin connection for plug-in wiring and shake proven connection
- control circuit: DC operated
 - low coil consumption (3.5 W at pull-in and at holding)
 - hum-free coil
- no auxiliary contact block permitted for mounting
- for rail and wall mounting

Ordering details

IEC		UL/CSA		Rated control circuit voltage U_c	Auxiliary contacts fitted	Type	Order code	Pkg qty	Weight (1 pce)
Rated operational power	current $0 \leq 40^\circ\text{C}$	3-phase motor rating	General use rating						
400 V	AC-3	480 V		V DC					kg
kW	AC-1	hp							

VBC7 mini reversing contactors

Rated power (kW)	Rated current (A)	3-phase motor rating (hp)	Rated voltage (V)	Rated current (A)	NO	NC	Type	Order code	Pkg qty	Weight (kg)
5.5	20	5	600 V / 16 A	12	1	0	VBC7-30-10-F-07	GJL1313903R0107	5	0.345
					0	1	VBC7-30-01-F-07	GJL1313903R0017	5	0.345
				24	1	0	VBC7-30-10-F-01	GJL1313903R0101	5	0.345
					0	1	VBC7-30-01-F-01	GJL1313903R0011	5	0.345
				48	1	0	VBC7-30-10-F-16	GJL1313903R1106	5	0.345
					0	1	VBC7-30-01-F-16	GJL1313903R1016	5	0.345
				60	1	0	VBC7-30-10-F-03	GJL1313903R0103	5	0.345
					0	1	VBC7-30-01-F-03	GJL1313903R0013	5	0.345
				110 ... 125	1	0	VBC7-30-10-F-04	GJL1313903R0104	5	0.345
					0	1	VBC7-30-01-F-04	GJL1313903R0014	5	0.345
				220 ... 240	1	0	VBC7-30-10-F-05	GJL1313903R0105	5	0.345
					0	1	VBC7-30-01-F-05	GJL1313903R0015	5	0.345

Other types on request

Main dimensions mm, inches

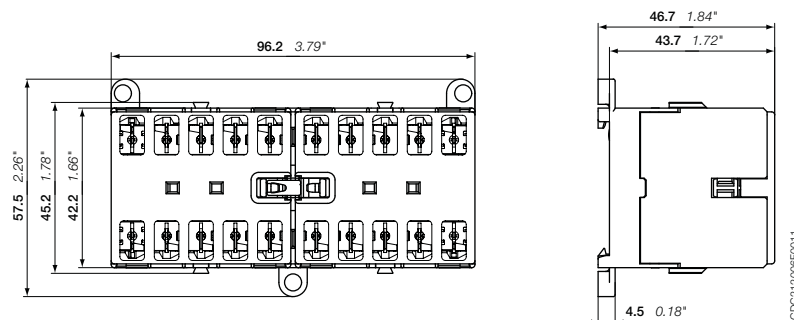

VBC7

2CDC212006F0011

2CDC102036C0201

VB7A 3-pole mini reversing contactors – with flat pin connection

4 to 5.5 kW

AC operated – with safety blocking function



VB7A-30-10-F

2CDC211003F0011

Description

VB7A 3-pole compact design reversing contactors are space optimized control products mainly used for switching resistive or motor loads up to 690 V AC.

These reversing contactors are designed with:

- built-in mechanical interlock and safety blocking function. The safety blocking function is triggered if the voltage is applied to the coil of the contactor to be switched on before the contactor to be switched off has dropped out. The contactor coils are designed for continuous operation when the contactor is de-energised i.e. the coil is not damaged if the mechanical interlock prevents switch-on of the contactor with the coil voltage applied.
- flat pin connection for plug-in wiring and shake proven connection
- control circuit: AC operated
 - low coil consumption (3.5 VA at pull-in and at holding)
- hum-free coil
- no auxiliary contact block permitted for mounting
- for rail and wall mounting

Ordering details

IEC		UL/CSA		Rated control circuit voltage U_c		Auxiliary contacts fitted	Type	Order code	Pkg qty	Weight (1 pce)
Rated operational power	current $\theta \leq 40^\circ\text{C}$	3-phase motor rating	General use rating	50 Hz	60 Hz					
400 V AC-3 kW	AC-1 A	hp		V AC	V AC				pce	kg

VB7A mini reversing contactors with safety blocking function

Rated operational power	current	3-phase motor rating	General use rating	50 Hz	60 Hz	1 0	0 1	Type	Order code	Pkg qty	Weight (1 pce)
5.5	20	5	600 V / 16 A	24	24	1	0	VB7A-30-10-F-01	GJL1311913R0101	5	0.345
						0	1	VB7A-30-01-F-01	GJL1311913R0011	5	0.345
				42	42	1	0	VB7A-30-10-F-02	GJL1311913R0102	5	0.345
						0	1	VB7A-30-01-F-02	GJL1311913R0012	5	0.345
				48	48	1	0	VB7A-30-10-F-03	GJL1311913R0103	5	0.345
						0	1	VB7A-30-01-F-03	GJL1311913R0013	5	0.345
				110 ... 127	110 ... 127	1	0	VB7A-30-10-F-84	GJL1311913R8104	5	0.345
						0	1	VB7A-30-01-F-84	GJL1311913R8014	5	0.345
				220 ... 240	220 ... 240	1	0	VB7A-30-10-F-80	GJL1311913R8100	5	0.345
						0	1	VB7A-30-01-F-80	GJL1311913R8010	5	0.345
				380 ... 415	380 ... 415	1	0	VB7A-30-10-F-85	GJL1311913R8105	5	0.345
						0	1	VB7A-30-01-F-85	GJL1311913R8015	5	0.345

Other types on request

Main dimensions mm, inches

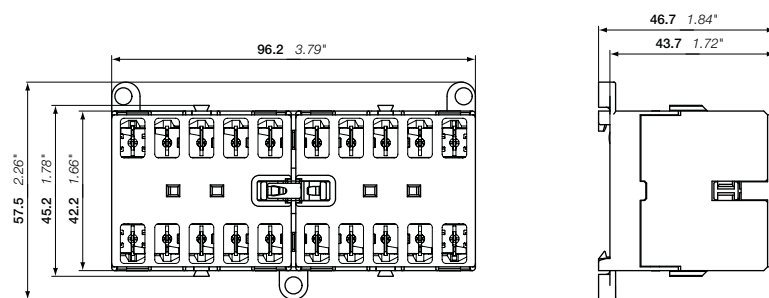

VB7A

2CDC212006F0011

2CDC102037C0201

VBC7A 3-pole mini reversing contactors – with flat pin connection 4 to 5.5 kW

DC operated – with safety blocking function



2CDC21002F0011

3

VBC7A-30-10-F

Description

VBC7A 3-pole compact design reversing contactors are space optimized control products mainly used for switching resistive or motor loads up to 690 V AC.

These reversing contactors are designed with:

- built-in mechanical interlock and safety blocking function. The safety blocking function is triggered if the voltage is applied to the coil of the contactor to be switched on before the contactor to be switched off has dropped out. The contactor coils are designed for continuous operation when the contactor is de-energised i.e. the coil is not damaged if the mechanical interlock prevents switch-on of the contactor with the coil voltage applied.
- flat pin connection for plug-in wiring and shake proven connection
- control circuit: DC operated
 - low coil consumption (3.5 W at pull-in and at holding)
 - hum-free coil
 - no auxiliary contact block permitted for mounting
- for rail and wall mounting

Ordering details

IEC	UL/CSA	Rated control circuit voltage	Auxiliary contacts fitted	Type	Order code	Pkg qty	Weight (1 pce)
Rated operational power 400 V AC-3 kW	3-phase motor rating 480 V hp	General use rating V DC					kg
$\theta \leq 40^\circ\text{C}$							

VBC7A mini reversing contactors with safety blocking function

Rated operational power (kW)	Rated operational current (A)	3-phase motor rating (hp)	Rated control circuit voltage (V DC)	Rated control circuit voltage (V AC)	Auxiliary contacts fitted	Type	Order code	Pkg qty	Weight (1 pce) (kg)
5.5	20	5	600 V / 16 A	12	1 0	VBC7A-30-10-F-07	GJL1313913R0107	5	0.345
					0 1	VBC7A-30-01-F-07	GJL1313913R0017	5	0.345
				24	1 0	VBC7A-30-10-F-01	GJL1313913R0101	5	0.345
					0 1	VBC7A-30-01-F-01	GJL1313913R0011	5	0.345
				48	1 0	VBC7A-30-10-F-16	GJL1313913R1106	5	0.345
					0 1	VBC7A-30-01-F-16	GJL1313913R1016	5	0.345
				60	1 0	VBC7A-30-10-F-03	GJL1313913R0103	5	0.345
					0 1	VBC7A-30-01-F-03	GJL1313913R0013	5	0.345
				110 ... 125	1 0	VBC7A-30-10-F-04	GJL1313913R0104	5	0.345
					0 1	VBC7A-30-01-F-04	GJL1313913R0014	5	0.345
				220 ... 240	1 0	VBC7A-30-10-F-05	GJL1313913R0105	5	0.345
					0 1	VBC7A-30-01-F-05	GJL1313913R0015	5	0.345

Other types on request

Main dimensions mm, inches

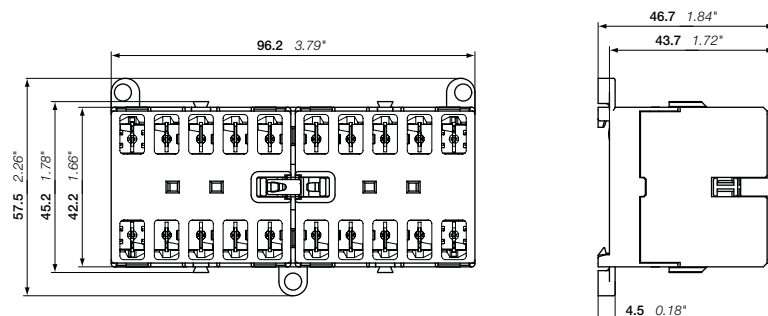

VBC7A

2CDC21002F0011

2CDC102038C0201

BC6, BC7 3-pole interface mini contactors – with flat pin connection 4 to 5.5 kW DC operated



BC6-30-10-F

2CDC211041F0011



BC7-30-10-F

2CDC211024F0011

Description

BC6, BC7 3-pole interface mini contactors are compact control products mainly used for switching resistive or motor loads up to 690 V AC.

These contactors are designed with:

- flat pin connection for plug-in wiring and shake proven connection
- 3 main poles and one built-in auxiliary contact
- control circuit: DC operated
 - low coil consumption (1.4 ... 2.4 W at pull-in and at holding)
- hum-free coil
- no auxiliary contact block permitted for mounting
- designed for rail or wall mounting

Ordering details

IEC	UL/CSA	Rated control circuit voltage: U_c	Auxiliary contacts fitted	Type	Order code	Pkg qty	Weight (1 pce)		
Rated operational power 400 V AC-3 kW	3-phase motor rating $\theta \leq 40^\circ\text{C}$ AC-1 A hp 480 V	General use rating					kg		
DC operation 24 V / 1.4 W									
4	20	3	300 V / 12 A	24	1 0 0 1	BC6-30-10-F-1.4-81 BC6-30-01-F-1.4-81	GJL1213003R8101 GJL1213003R8011	10	0.170
5.5	20	5	600 V / 16 A	24	1 0 0 1	BC7-30-10-F-1.4-81 BC7-30-01-F-1.4-81	GJL1313003R8101 GJL1313003R8011	10	0.170
DC operation 17 ... 32 V / 2.4 W									
4	20	3	300 V / 12 A	17 ... 32	1 0 0 1	BC6-30-10-F-2.4-51 BC6-30-01-F-2.4-51	GJL1213003R5101 GJL1213003R5011	10	0.170
5.5	20	5	600 V / 16 A	17 ... 32	1 0 0 1	BC7-30-10-F-2.4-51 BC7-30-01-F-2.4-51	GJL1313003R5101 GJL1313003R5011	10	0.170

Other types on request

Main dimensions mm, inches

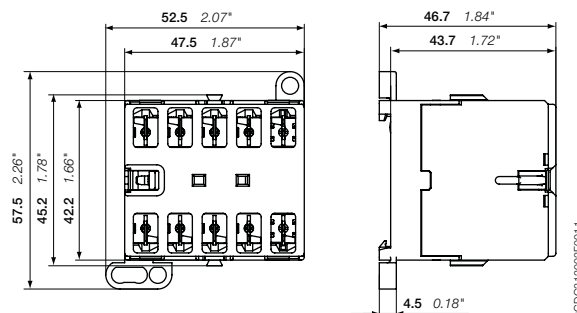

BC6, BC7

2CDC212022F0011

K6 4-pole mini contactor relays – with flat pin connection AC operated



2CDC021103490011

3

K6-22Z-F

Description

K6 4-pole mini-contactor relays are space optimized control products mainly used for control functions or for small loads up to 4 A.

These contactors are designed with:

- flat pin connection for plug-in wiring and shake proven connection
- 4-poles with various contact combinations
- control circuit: AC operated
 - low coil consumption (3.5 VA at pull-in and at holding)
- hum-free coil
- add-on auxiliary contact blocks for side mounting
- for rail and wall mounting
- add-on auxiliary contact blocks for side mounting

Ordering details

Rated control circuit voltage U_c		Type	Order code	Pkg qty	Weight (1 pce) kg
50 Hz V AC	60 Hz V AC				
K6 4-pole mini contactor relays					
24	24	K6-22Z-F-01	GJH1211003R0221	10	0.170
42	42	K6-22Z-F-02	GJH1211003R0222	10	0.170
48	48	K6-22Z-F-03	GJH1211003R0223	10	0.170
110 ... 127	110 ... 127	K6-22Z-F-84	GJH1211003R8224	10	0.170
220 ... 240	220 ... 240	K6-22Z-F-80	GJH1211003R8220	10	0.170
380 ... 415	380 ... 415	K6-22Z-F-85	GJH1211003R8225	10	0.170
24	24	K6-31Z-F-01	GJH1211003R0311	10	0.170
42	42	K6-31Z-F-02	GJH1211003R0312	10	0.170
48	48	K6-31Z-F-03	GJH1211003R0313	10	0.170
110 ... 127	110 ... 127	K6-31Z-F-84	GJH1211003R8314	10	0.170
220 ... 240	220 ... 240	K6-31Z-F-80	GJH1211003R8310	10	0.170
380 ... 415	380 ... 415	K6-31Z-F-85	GJH1211003R8315	10	0.170
24	24	K6-40E-F-01	GJH1211003R0401	10	0.170
42	42	K6-40E-F-02	GJH1211003R0402	10	0.170
48	48	K6-40E-F-03	GJH1211003R0403	10	0.170
110 ... 127	110 ... 127	K6-40E-F-84	GJH1211003R8404	10	0.170
220 ... 240	220 ... 240	K6-40E-F-80	GJH1211003R8400	10	0.170
380 ... 415	380 ... 415	K6-40E-F-85	GJH1211003R8405	10	0.170

Other types on request

Main dimensions mm, inches

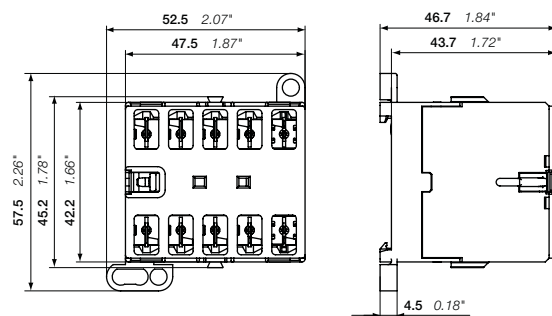

K6

2CDC0212020F0011

2CDC102040C0201

KC6 4-pole mini contactor relays – with flat pin connection DC operated



KC6-22Z-F-01

2CDC21102BF0011

Description

K6 4-pole mini-contactor relays are space optimized control products mainly used for control functions or for small loads up to 4 A.

These contactors are designed with:

- flat pin connection for plug-in wiring and shake proven connection
- 4-poles with various contact combinations
- control circuit: AC operated
 - low coil consumption (3.5 VA at pull-in and at holding)
- hum-free coil
- add-on auxiliary contact blocks for side mounting
- for rail and wall mounting

Ordering details

Rated control circuit voltage U_c V DC	Type	Order code	Pkg qty	Weight (1 pce) kg
K6 4-pole mini contactor relays				
12	KC6-22Z-F-07	GJH1213003R0227	10	0.170
24	KC6-22Z-F-01	GJH1213003R0221	10	0.170
48	KC6-22Z-F-16	GJH1213003R1226	10	0.170
110 ... 125	KC6-22Z-F-04	GJH1213003R0224	10	0.170
220 ... 240	KC6-22Z-F-05	GJH1213003R0225	10	0.170
12	KC6-31Z-F-07	GJH1213003R0317	10	0.170
24	KC6-31Z-F-01	GJH1213003R0311	10	0.170
48	KC6-31Z-F-16	GJH1213003R1316	10	0.170
110 ... 125	KC6-31Z-F-04	GJH1213003R0314	10	0.170
220 ... 240	KC6-31Z-F-05	GJH1213003R0315	10	0.170
24	KC6-40E-F-01	GJH1213003R0401	10	0.170
48	KC6-40E-F-16	GJH1213003R1406	10	0.170
110 ... 125	KC6-40E-F-04	GJH1213003R0404	10	0.170
220 ... 240	KC6-40E-F-05	GJH1213003R0405	10	0.170

Other types on request

Main dimensions mm, inches

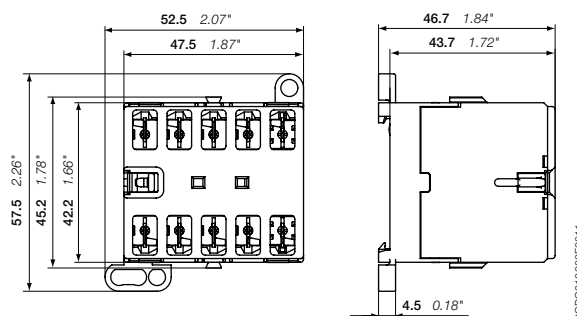

KC6

2CDC21102BF0011

2CDC102041C0201

KC6 4-pole interface mini contactor relays – with flat pin connection DC operated



2CDC211038P0011

3

KC6-31Z-F-05

Description

KC6 4-pole interface mini-contactor relays are space optimized control products mainly used for control functions or for small loads up to 4 A.

These contactors are designed with:

- flat pin connection for plug-in wiring and shake proven connection
- 4-poles with various contact combinations
- control circuit: AC operated
 - low coil consumption (1.4 ... 2.4 W at pull-in and at holding)
- hum-free coil
- no auxiliary contact block permitted for mounting
- for rail and wall mounting
- no add-on auxiliary contact blocks possible

Ordering details

Rated control circuit voltage U_c V DC	Type	Order code	Pkg qty	Weight (1 pce) kg
DC operation 24 V / 1.4 W				
24	KC6-31Z-F-1.4-81	GJH1213003R8311	10	0.170
24	KC6-40E-F-1.4-81	GJH1213003R8401	10	0.170
DC operation 17 ... 32 V / 2.4 W				
17 ... 32	KC6-31Z-F-51	GJH1213003R5311	10	0.170
17 ... 32	KC6-40E-F-51	GJH1213003R5401	10	0.170

Other types on request

Main dimensions mm, inches

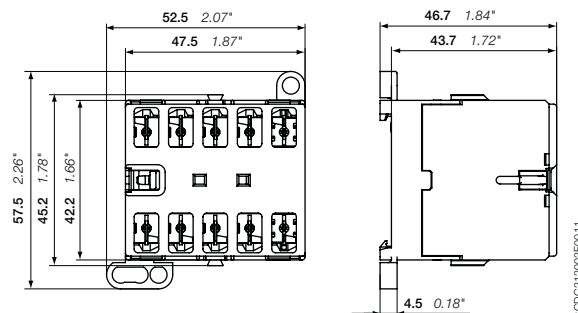

KC6

2CDC21202P0011

2CDC102045C0201

B6, B7, BC6, BC7 3- and 4-pole mini contactors

VB6, VB7, VBC6, VBC7 3-pole mini reversing contactors

Accessories



2CDC211012F0010

CAF6-11N



2CDC211007F0010

RV-BC6/250



2CDC211008F0010

CA6-11E



2CDC211018F0011

CA6-11E-P



2CDC211028F0011

CA6-11E-F



SSZ7792R

BSM6-30



2CDC231012F0011

T16-16

Ordering details

Suitable for	Auxiliary contacts	Type	Order code	Pkg qty	Weight (1 pce)	
					kg	
Front mounted instantaneous auxiliary contact blocks (not allowed for mounting on TBC, B6S, B7S, interface contactors) ¹⁾						
B6-, B7-40-00, BC6-, BC7-40-00	1 1	CAF6-11E	GJL1201330R0002	10	0.020	
VB6, VB7, VBC6, VBC7, VB6A, VB7A	2 0	CAF6-20E	GJL1201330R0006	10	0.020	
VBC6A, VBC7A	0 2	CAF6-02E	GJL1201330R0010	10	0.020	
B6-, B7-30-10, BC6-, BC7-30-10	1 1	CAF6-11M	GJL1201330R0003	10	0.020	
VB6, VB7, VBC6, VBC7, VB6A, VB7A	2 0	CAF6-20M	GJL1201330R0007	10	0.020	
VBC6A, VBC7A	0 2	CAF6-02M	GJL1201330R0011	10	0.020	
B6-, B7-30-01, BC6-, BC7-30-01	1 1	CAF6-11N	GJL1201330R0004	10	0.020	
VB6, VB7, VBC6, VBC7, VB6A, VB7A	2 0	CAF6-20N	GJL1201330R0008	10	0.020	
VBC6A, VBC7A	0 2	CAF6-02N	GJL1201330R0012	10	0.020	
Side mounted instantaneous auxiliary contact block ¹⁾						
B6-, B7-40-00, BC6-, BC7-40-00	1 1	CA6-11E	GJL1201317R0002	10	0.030	
B6-, B7-30-10, BC6-, BC7-30-10	1 1	CA6-11M	GJL1201317R0003	10	0.030	
B6-, B7-30-01, BC6-, BC7-30-01	1 1	CA6-11N	GJL1201317R0004	10	0.030	
Side mounted instantaneous auxiliary contact block with soldering pins ²⁾						
B6-, B7-40-00-P, BC6-, BC7-40-00-P	1 1	CA6-11E-P	GJL1201319R0002	10	0.025	
B6-, B7-30-10-P, BC6-, BC7-30-10-P	1 1	CA6-11M-P	GJL1201319R0003	10	0.025	
B6-, B7-30-01-P, BC6-, BC7-30-01-P	1 1	CA6-11N-P	GJL1201319R0004	10	0.025	
Side mounted instantaneous auxiliary contact block with flat pin connection ²⁾						
B6-, B7-40-00-F, BC6-, BC7-40-00-F	1 1	CA6-11E-F	GJL1201318R0002	10	0.025	
B6-, B7-30-10-F, BC6-, BC7-30-10-F	1 1	CA6-11M-F	GJL1201318R0003	10	0.025	
B6-, B7-30-01-F, BC6-, BC7-30-01-F	1 1	CA6-11N-F	GJL1201318R0004	10	0.025	
Soldering receptacle (I_{in} = 10 A, AC-3: 500 V / 8 A, 690 V / 3.5 A, UL: 300 V / 8 A)						
B6, B7, BC6, BC7		LB6	GJL1201902R0001	10	0.020	
2-pole aux.contact blocks CA		LB6-CA	GJL1201903R0001	10	0.010	
¹⁾ CA6 and CAF6 must not be fitted simultaneously.						
Suitable for	Rated control circuit voltage U _c V DC	Connection type	Type	Order code	Pkg qty	Weight (1 pce)
Surge suppressors for contactor coils						
BC6, BC7	24 ... 60	Cable lug	RV-BC6/60	GHV2501902R0002	10	0.005
		Flat pin, 2.8 mm	RV-BC6-F/60	GHV2501902R0003	10	0.005
	50 ... 250	Cable lug	RV-BC6/250	GHV2501903R0002	10	0.005
		Flat pin, 2.8 mm	RV-BC6-F/250	GHV2501903R0003	10	0.010
	380	Cable lug	RV-BC6/380	GHV2501904R0002	10	0.005
		Flat pin, 2.8 mm	RV-BC6-F/380	GHV2501904R0003	10	0.010
Note: Mini contactors for AC operation have an integrated protective circuit						
Connecting links with manual motor starters						
To connect B..VB.. mini contactor to MS116, MS132			BEA7/132	1SBN080906R1002	10	0.013
To connect B..VB.. mini contactors to MS325			BEA7/325	1SBN080906R1001	10	0.021
Connection sets for reversing contactors						
VB6, VB7, VBC6, VBC7, VB6A, VB7A, VBC6A, VBC7A, cross-section 1.8 mm ²			BSM6-30	GJL1201908R0001	10	0.010
Parallel connecting link						
B6, B7, BC6, BC7			LP6	GJL1201907R0001	100	0.009
Cover cap, transparent fitting to DIN rail design, sealable						
B6, B7, BC6, BC7			LT6-B	GJL1201906R0001	10	0.015
Plastic label for markings						
B6, B7, BC6, BC7			BA5-50	1SBN110000R1000	50	0.020
Thermal overload relays						
			T16 (see "Thermal overload relays" chapter)		1	0.100

K6, KC6 4-pole mini contactor relays

Accessories



2CDC211019FC011

CAF6-11K



2CDC211009F0010

CA6-11K



2CDC211011F0010

CA6-11K-P



2CDC211010F0010

CA6-11K-F



2CDC211006F0010

LT6-B



2CDC211007F0010

RV-BC6/250

Ordering details

Suitable for	Auxiliary contacts	Type	Order code	Pkg qty	Weight (1 pce)
					kg

Front mounted instantaneous auxiliary contact blocks ¹⁾

K6, KC6	1 1	CAF6-11K	GJL1201330R0001	10	0.020
	2 0	CAF6-20K	GJL1201330R0005	10	0.020
	0 2	CAF6-02K	GJL1201330R0009	10	0.020

Side mounted instantaneous auxiliary contact block ¹⁾

K6, KC6	1 1	CA6-11K	GJL1201317R0001	10	0.030
---------	-----	---------	-----------------	----	-------

Side mounted instantaneous auxiliary contact block with soldering pins ²⁾

K6..P, KC6..P	1 1	CA6-11K-P	GJL1201319R0001	10	0.025
---------------	-----	-----------	-----------------	----	-------

Side mounted instantaneous auxiliary contact block with flat pin connection ²⁾

K6..F, KC6..F	1 1	CA6-11K-F	GJL1201318R0001	10	0.025
---------------	-----	-----------	-----------------	----	-------

Soldering receptacle ($I_g < 8 A$)

K6, KC6	LB6	GJL1201902R0001	10	0.020
2-pole auxiliary contact blocks CA	LB6-CA	GJL1201903R0001	10	0.010

¹⁾ CA6 and CAF6 must not be fitted simultaneously.

Suitable for	Rated control circuit voltage U_c V DC	Connection type	Type	Order code	Pkg qty	Weight (1 pce)
						kg

Surge suppressors for contactor coils

KC6	24 ... 60	Cable lug	RV-BC6/60	GHV2501902R0002	10	0.005
		Flat pin, 2.8 mm	RV-BC6-F/60	GHV2501902R0003	10	0.005
	50 ... 250	Cable lug	RV-BC6/250	GHV2501903R0002	10	0.005
		Flat pin, 2.8 mm	RV-BC6-F/250	GHV2501903R0003	10	0.010
	380	Cable lug	RV-BC6/380	GHV2501904R0002	10	0.005
		Flat pin, 2.8 mm	RV-BC6-F/380	GHV2501904R0003	10	0.010

Note: Mini contactors for AC operation have an integrated protective circuit



Cover cap, transparent fitting to DIN rail design, sealable

K6, KC6	LT6-B	GJL1201906R0001	10	0.015
---------	-------	-----------------	----	-------

B6, B7, BC6, BC7, TBC7 3- and 4-pole mini contactors VB6, VB7, VBC6, VBC7 3- and 4-pole mini reversing contactors

Technical data

Main pole – Utilization characteristics according to IEC

Contactor types	AC operated	B6, VB6, VB6A	B7, VB7, VB7A
	DC operated	BC6, VBC6, VBC6A	BC7, TBC7, VBC7, VBC7A
Standards		IEC/EN 60947-1, IEC/EN 60947-4-1	
Rated operational voltage U_e		690 V AC	
Rated frequency (without derating)		DC or 50 / 60 Hz	
Conventional free-air thermal current I_{th} acc. to IEC 60947-4-1, open contactors, $\theta \leq 40^\circ\text{C}$, with conductor cross-sectional area		Screw terminal types: 20 A Flat pin types: 20 A Soldering pin types: 12 A	
AC-1 Utilization category for air temperature close to contactor $\theta \leq 40^\circ\text{C}$			
I_e / Rated operational current AC-1 $U_{e\max} \leq 690\text{ V}, 50/60\text{ Hz}$	220-230-240 V	Screw terminal types: 20 A Flat pin types: 20 A Soldering pin types: 12 A	
	380-400 V	Screw terminal types: 20 A Flat pin types: 20 A Soldering pin types: 12 A	
	440 V	Screw terminal types: 20 A Flat pin types: 20 A Soldering pin types: 12 A	
	500 V	12 A	
	690 V	6 A	
AC-1 Utilization category for air temperature close to contactor $\theta \leq 55^\circ\text{C}$			
I_e / Rated operational current AC-1 $U_{e\max} \leq 690\text{ V}, 50/60\text{ Hz}$	220-230-240 V	Screw terminal types: 16 A Flat pin types: 16 A Soldering pin types: 12 A	
	380-400 V	Screw terminal types: 16 A Flat pin types: 16 A Soldering pin types: 12 A	
	440 V	Screw terminal types: 16 A Flat pin types: 16 A Soldering pin types: 12 A	
	500 V	12 A	
	690 V	6 A	
AC-3 Utilization category for air temperature close to contactor $\theta \leq 55^\circ\text{C}$			
I_e / Rated operational current AC-3 	220 / 230 / 240 V	8.9 / 8.5 / 8.1 A	11.8 / 11.3 / 10.8 A
	380 / 400 V	8.9 / 8.5 A	12.1 / 11.5 A
	440 V	7.4 A	10.1 A
	500 V	6.8 A	9.2 A
	690 V	3.8 A	3.8 A
Rated operational power AC-3  1500 r.p.m. 50 Hz 1800 r.p.m. 60 Hz 3-phase motors	220-230-240 V	2.2 kW	3 kW
	380-400 V	4 kW	5.5 kW
	440 V	4 kW	5.5 kW
	500 V	4 kW	5.5 kW
	690 V	3 kW	3 kW
DC-1 Utilization category for air temperature close to contactor $\theta \leq 55^\circ\text{C}$			
I_e / Rated operational current DC-1	110 V	-	4 A
	220 V	-	0.6 A
DC-3 Utilization category for air temperature close to contactor $\theta \leq 55^\circ\text{C}$			
I_e / Rated operational current DC-3	110 V	-	1.5 A
	220 V	-	0.25 A
DC-5 Utilization category for air temperature close to contactor $\theta \leq 55^\circ\text{C}$			
I_e / Rated operational current DC-5	110 V	-	0.4 A
	220 V	-	0.2 A
Rated making capacity AC-3		10 x I_e AC-3 acc. to IEC 60947-4-1	
Rated breaking capacity AC-3		8 x I_e AC-3 acc. to IEC 60947-4-1	
Short-circuit protection device for contactors without thermal O/L relay - motor protection excluded $U_e \leq 500\text{ V AC}$ - fuse type gG		Type 1: 25 A / Type 2: 25 A	
Rated short-time withstand current I_{cw} at 40°C ambient temperature, in free air from a cold state	10 s	64 A	96 A
Maximum breaking capacity $\cos \varphi = 0.45$	at 400 V	64 A	96 A
Maximum electrical switching frequency	AC-1	300 cycles/h	
	AC-3	600 cycles/h	
	DC-1, DC-3, DC-5	600 cycles/h	

B6, B7, BC6, BC7, TBC7 3- and 4-pole mini contactors VB6, VB7, VBC6, VBC7 3- and 4-pole mini reversing contactors

Technical data

Main pole – Utilization characteristics according to UL/NEMA/CSA

Contactor types	AC operated	B6, VB6, VB6A	B7, VB7, VB7A
	DC operated	BC6, VBC6, VBC6A	BC7, TBC7, VBC7, VBC7A
Standards	UL 508, CSA C22.2 N°14		
Maximum operational voltage	600 V		
UL/CSA general use rating	12 A / 300 V		16 A / 600 V
UL/CSA maximum 1-phase motor rating			
Full load current	120 V AC	5.8 A	13.8 A
	240 V AC	4.9 A	10.0 A
Horse power rating	120 V AC	0.25 hp	0.75 hp
	240 V AC	0.5 hp	1.5 hp
UL/CSA maximum 3-phase motor rating			
Full load current ¹⁾	200 / 208 V AC	4.8 / 4.6 A	7.8 / 10.6 A
	220-240 V AC	6.8 A	9.6 A
	440-480 V AC	4.8 A	7.6 A
	550-600 V AC	1.7 A	6.1 A
Horse power rating ¹⁾	200 / 208 V AC	1 hp	2 / 3 hp
	220-240 V AC	2 hp	3 hp
	440-480 V AC	3 hp	5 hp
	550-600 V AC	1 hp	5 hp
Resistive Heating	300 V per pole	8 A	8 A
Incandescent Lamps	300 V per pole	6 A	6 A
Fluorescent Lamps	300 V per pole	8.4 A	8.4 A
Short-circuit protection device for contactors			
without thermal overload relay - motor protection excluded			
Fuse rating	600 V	40 A	
Fuse type, 600 V	600 V	Class J	
Maximum electrical switching frequency			
For resistive loads AC-1	300 cycles/h		
For motor loads AC-3	600 cycles/h		

¹⁾ For the corresponding kW/A or hp/A values of 1500 r.p.m, 50 Hz or 1800 r.p.m, 60 Hz, 3-phase motors, see "Motor rated operational powers and currents".

General technical data

Contactor types	AC operated	B6, VB6, VB6A	B7, VB7, VB7A
	DC operated	BC6, VBC6, VBC6A	BC7, TBC7, VBC7, VBC7A
Rated insulation voltage U _i			
acc. to IEC 60947-4-1	690 V		
acc. to UL/CSA	600 V		
Rated impulse withstand voltage U _{imp}	6 kV		
Ambient air temperature, close to contactor			
Operation	Fitted with thermal overload relay	-25 ... +50 °C	
	Without thermal overload relay	-25 ... +55 °C	
Storage	-40 ... +80 °C		
Climatic withstand	Acc. to IEC 60947-1 Annex Q		
Maximum operating altitude (without derating)	2000 m		
Mechanical durability	10 ⁷ operating cycles		
Resistance to shock	Half-sine		
acc. IEC 60068-2-27 and EN 60068-2-27	15 g / 11 ms		
acc. to IEC/EN 60947-1 Annex. Q	Category E		
Resistance to vibrations	Sinusoidal		
acc. IEC 60068-2-27 and EN 60068-2-27	5 g / 3 ... 150 Hz		
acc. to IEC/EN 60947-1 Annex. Q	Category E		

B6, B7, BC6, BC7, TBC7 3- and 4-pole mini contactors VB6, VB7, VBC6, VBC7 3- and 4-pole mini reversing contactors

Technical data

Magnet system characteristics for B6, B7 contactors

Contactor types	AC operated	B6, VB6	B7, VB7
Coil operating limits acc. to IEC 60947-4-1	AC supply	0.85 ... 1.1 x U _c	
AC control voltage			
Rated control circuit voltage U _c		See ordering tables	
Coil consumption	Average pull-in value	3.5 VA / 3.5 W	
	Average holding value	3.5 VA / 3.5 W	
Drop-out voltage		0.20 ... 0.75 % of U _c	

Magnet system characteristics for BC6, BC7 contactors

Contactor types	DC operated	BC6, VBC6	BC7, VBC7
Coil operating limits acc. to IEC 60947-4-1	DC supply	0.85 ... 1.1 x U _c	
AC control voltage			
Rated control circuit voltage U _c		See ordering tables	
Coil consumption ¹⁾	Average pull-in value	3.5 VA / 3.5 W	
	Average holding value	3.5 VA / 3.5 W	
Drop-out voltage in % of U _{cmin}		0.10 ... 0.75 x U _c	

¹⁾ Interface mini-contactors: see coil consumption on ordering details pages

Magnet system characteristics for TBC7 contactors

Contactor types	DC operated	TBC7
Coil operating limits acc. to IEC 60947-4-1	DC supply	Wide range voltage supply see ordering tables, U _{cmin} ... U _{cmax}
AC control voltage		
Rated control circuit voltage U _c		See ordering tables
Coil consumption	Average pull-in value	5 VA / 5 W
	Average holding value	5 VA / 5 W
Drop-out voltage in % of U _{cmin}		≤ 0.20 % of U _{cmin}

Mounting characteristics and conditions for use

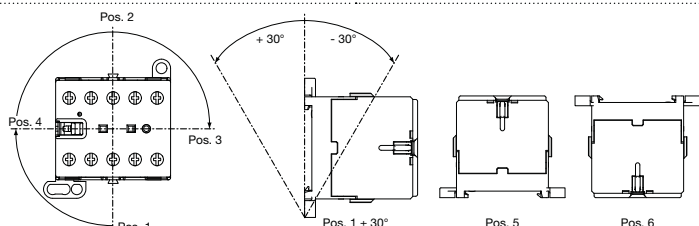
Contactor types	AC operated	B6, VB6, VB6A	B7, VB7, VB7A
	DC operated	BC6, VBC6, VBC6A	BC7, TBC7, VBC7, VBC7A
Mounting positions			
Mounting distances	The contactors can be assembled side by side		
Fixing	On rail acc. to IEC 60715, EN 60715 35 x 7.5 mm or 35 x 15 mm By screws (not supplied) 2 x M4 screws placed diagonally		

B6, B7, BC6, BC7, TBC7 3- and 4-pole mini contactors VB6, VB7, VBC6, VBC7 3- and 4-pole mini reversing contactors

Technical data

Auxiliary contacts for front mounting, side mounting and built-in according to IEC

Types	CA6, CAF6, built-in auxiliary contacts	
Standards	IEC/EN 60947-1, IEC/EN 60947-4-1	
Rated operational voltage U_e max	690 V	
Rated frequency (without derating)	DC or 50 / 60 Hz	
Conventional free-air thermal current I_m , $\theta \leq 40$ °C	6 A	
I_e / Rated operational current AC-15 acc. to IEC 60947-5-1	24 V 50/60 Hz	4 A
	110-120 V 50/60 Hz	4 A
	220-230-240 V 50/60 Hz	4 A
	380-400 V 50/60 Hz	3 A
	440 V 50/60 Hz	3 A
I_e / Rated operational current DC-13 acc. to IEC 60947-5-1	24 V DC	2.5 A
	110 V DC	0.7 A
	220 - 240 V DC	0.4 A
Short-circuit protection device	6 A, Type gG	
Minimum switching capacity with failure rate acc. to IEC 60947-5-4	17 V / 5 mA	
Maximum electrical switching frequency	AC-15	600 cycles/h
	DC-13	600 cycles/h

Auxiliary contacts for front mounting, side mounting and built-in according to UL/CSA

Types	CA6, CAF6, built-in auxiliary contacts	
Max. operational voltage	600 V AC	
Pilot duty	A600	
AC thermal rated current	5 A	

Accessories for mini contactors

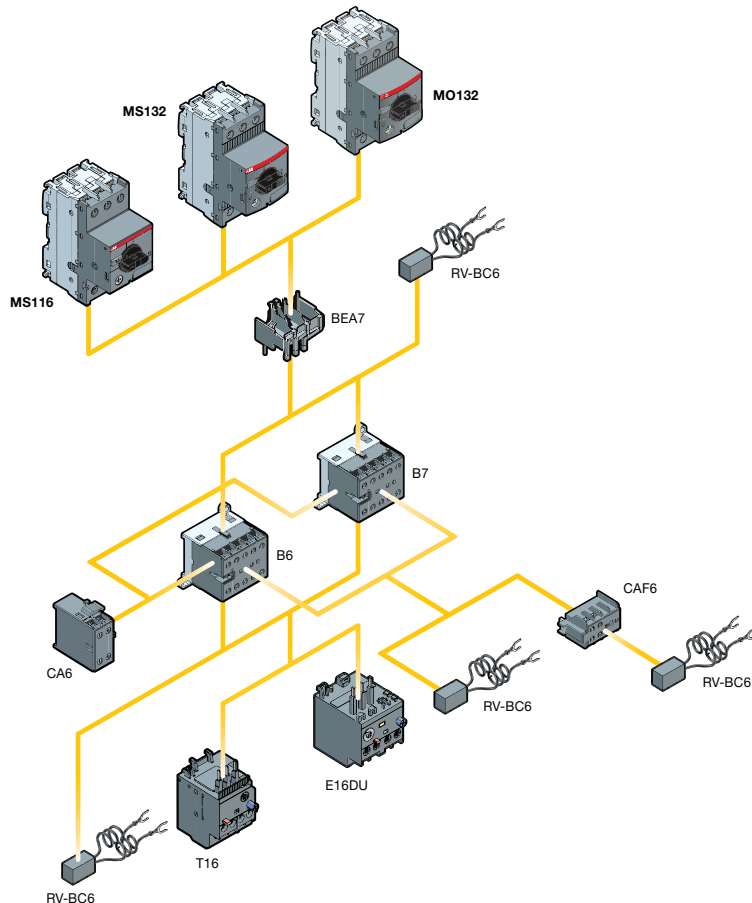

2XAN21201800011





2CDC102043C0201

B6, B7, BC6, BC7, TBC7 3- and 4-pole mini contactors

VB6, VB7, VBC6, VBC7 3- and 4-pole mini reversing contactors

Technical data

Connection characteristics

Contactor types	AC operated	B6, VB6, VB6A	B7, VB7, VB7A
	DC operated	BC6, VBC6, VBC6A	BC7, TBC7, VBC7, VBC7A
Main terminals ¹⁾	 <p>Screw terminals with cable clamp</p>		
Connection capacity			
Main conductors (poles)			
 Rigid: solid	1 or 2 x	1 ... 4 mm ²	
 Flexible without ferrule	1 or 2 x	1 ... 2.5 mm ²	
Connection capacity acc. to UL/CSA	1 or 2 x	AWG 22 ... 10	
Stripping length	9 mm		
Tightening torques	0.8 ... 1.1 Nm / 7 lb.in		
Connection capacity – auxiliary conductors (built-in auxiliary terminals + coil terminals)			
 Rigid: solid	1 or 2 x	1 ... 4 mm ²	
 Flexible without ferrule	1 or 2 x	1 ... 2.5 mm ²	
Connection capacity acc. to UL/CSA	1 or 2 x	AWG 22 ... 10	
Stripping length	9 mm		
Tightening torques	0.8 ... 1.1 Nm / 7 lb.in		
Coil terminals	0.8 ... 1.1 Nm / 7 lb.in		
Built-in auxiliary terminals	0.8 ... 1.1 Nm / 7 lb.in		
Degree of protection acc. to IEC 60947-1 / EN 60947-1 and IEC 60529 / EN 60529			
Main terminals	IP20		
Coil terminals	IP20		
Built-in auxiliary terminals	IP20		
Screw terminals (Delivered in open position, screws of unused terminals must be tightened)			
All terminals	M3		
Screwdriver type	Flat Ø 5.5 mm / Pozidriv 1		

¹⁾ Soldering pin connection acc. to DIN 40801: 0.8 x 1 mm / 0.8 x 2.54 mm
Flat pin connection acc. to DIN 46248: 1 x 6.3 mm / 1 x 2.8 mm

K6, KC6, TKC6 4-pole mini contactor relays

Technical data

Main pole – Utilization characteristics according to IEC

Contactor types	AC operated	K6
	DC operated	KC6, TKC6
Standards	IEC/EN 60947-1, IEC/EN 60947-4-1, IEC/EN 60947-5-1	
Rated operational voltage U_{max}	690 V	
Rated frequency (without derating)	DC or 50 / 60 Hz	
Conventional free-air thermal current I_{th} , $\theta \leq 40$ °C	6 A	
I_{e} / Rated operational current AC-15 acc. to IEC 60947-5-1	24 V 50/60 Hz	4 A
	110-120 V 50/60 Hz	4 A
	220-230-240 V 50/60 Hz	4 A
	380-400 V 50/60 Hz	3 A
	440 V 50/60 Hz	3 A
	480-500 V 50/60 Hz	2 A
I_{e} / Rated operational current DC-13 acc. to IEC 60947-5-1	24 V DC	2.5 A
	110 V DC	0.7 A
	220-240 V DC	0.4 A
Short-circuit protection device for contactors $U_{\text{e}} \leq 500$ V AC, fuse type gG	6 A	
Minimum switching capacity	17 V / 5 mA	
Maximum electrical switching frequency	AC-15	600 cycles/h
	DC-13	600 cycles/h

Main pole – Utilization characteristics according to UL/NEMA/CSA

Contactor types	AC operated	K6
	DC operated	KC6, TKC6
Standards	UL 508, CSA C22.2 No14	
Maximum operational voltage	600 V AC	
Pilot duty	A600	

K6, KC6, TKC6 4-pole mini contactor relays

Technical data

General technical data

Contactor relay types	AC operated	K6
	DC operated	KC6, TKC6
Rated insulation voltage U_i		
acc. to IEC 60947-5-1		690 V
acc. to UL/CSA		600 V
Rated impulse withstand voltage U_{imp}		6 kV
Electromagnetic compatibility		
Ambient air temperature close to contactor relay	Operation in free air	-25 ... +55 °C
	Storage	-40 ... +80 °C
Climatic withstand		Acc. to IEC 60068-2-30
Maximum operating altitude (without derating)		2000 m
Mechanical durability		10 ⁷ operating cycles
Resistance to shock		Half-sine
acc. IEC 60068-2-27 and EN 60068-2-27		15 g / 11ms
acc. to IEC/EN 60947-1 Annex. Q		Category E
Resistance to vibrations		Sinusoidal
acc. IEC 60068-2-27 and EN 60068-2-27		5 g / 3 ... 150 Hz
acc. to IEC/EN 60947-1 Annex. Q		Category E

Magnet system characteristics for K6 contactor relays

Contactor relay types	AC operated	K6
Coil operating limits acc. to IEC 60947-4-1	AC supply	0.85 ... 1.1 x U_c
AC control voltage		
Coil consumption	Average pull-in value	3.5 VA / 3.5 W
	Average holding value	3.5 VA / 3.5 W
Drop-out voltage in % of U_c min.		Approx. 20 ... 75%

Magnet system characteristics for KC6, TKC6 contactor relays

Contactor relay types	DC operated	KC6	TKC6
Coil operating limits acc. to IEC 60947-5-1	DC supply	0.85 ... 1.1 x U_c	See ordering details
DC control voltage			
Coil consumption	Average pull-in value	3.5 VA / 3.5 W	5 VA / 5 W
	Average holding value	3.5 VA / 3.5 W	5 VA / 5 W
Drop-out voltage in % of U_c min.		10 ... 75 %	10 ... 75 %

K6, KC6, TKC6 4-pole mini contactor relays

Technical data

Mounting characteristics and conditions for use

Contactor types	AC operated	K6
	DC operated	KC6, TKC6
Mounting positions		
Mounting distances	The contactors can be assembled side by side.	
Fixing	On rail acc. to IEC 60715, EN 60715 By screws (not supplied)	
	35 x 7.5 mm or 35 x 15 mm 2 x M4 screws placed diagonally	

Connecting characteristics

Contactor relay types	AC operated	K6
	DC operated	KC6, TKC6
Main terminals ¹⁾	Screw terminals with cable clamp	
Connection capacity		
Main conductors (poles)		
Rigid: solid	1 or 2 x	1 ... 4 mm ²
Flexible without ferrule	1 or 2 x	1 ... 2.5 mm ²
Connection capacity acc. to UL/CSA	1 or 2 x	AWG 22 ... 10
Stripping length		9 mm
Tightening torques		0.8 ... 1.1 Nm / 7 lb.in
Degree of protection		
acc. to IEC 60947-1 / EN 60947-1 and IEC 60529 / EN 60529		
All	IP20	
Screw terminals	(Delivered in open position, screws of unused terminals must be tightened)	
All terminals	M3	
Screwdriver type	Flat Ø 5.5 / Pozidriv 1	

¹⁾ Soldering pin connection acc. to DIN 40801: 0.8 x 1 mm / 0.8 x 2.54 mm
 Flat pin connection acc. to DIN 46248: 1 x 6.3 mm / 1 x 2.8 mm

Mini contactors

Location of the connection terminals and terminal designation

Mini contactors

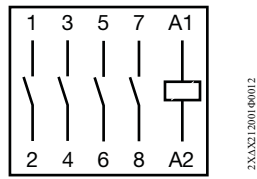

2XAX212001000012

B6(7)-40-00 ...
BC6(7)-40-00 ...

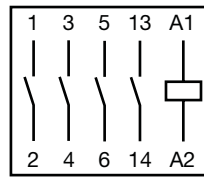

2XAX212002000012

B6(7)-30-10 ...
BC6(7)-30-10 ...

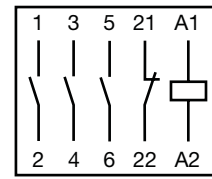

2XAX212003000012

B6(7)-30-01 ...
BC6(7)-30-01 ...

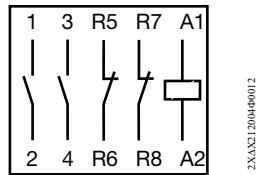

2XAX212004000012

B6(7)-22-00 ...
BC6(7)-22-00 ...

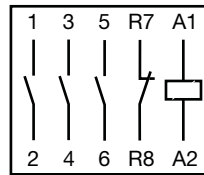

2XAX212005000012

B6(7)-31-00 ...
BC6(7)-31-00 ...

Compact reversing contactors

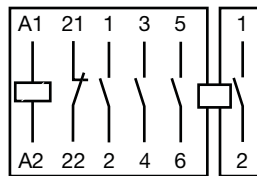

2XAX212006000012

VB6(7)-30-01 ...
VBC6(7)-30-01 ...

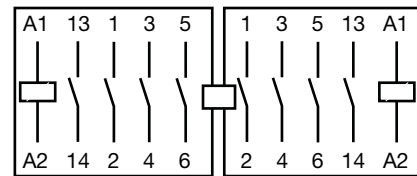

2XAX212007000012

VB6(7)-30-10 ...
VBC6(7)-30-10 ...

Mini contactor relays

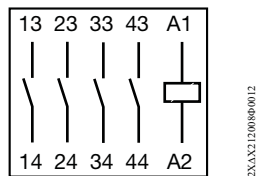

2XAX212008000012

K6-40E ...
KC6-40E ...

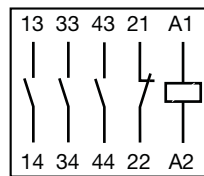

2XAX212009000012

K6-31Z ...
KC6-31Z ...

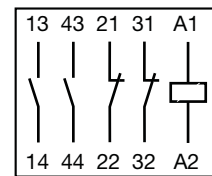

2XAX212010000012

K6-22Z ...
KC6-22Z ...

Auxiliary switches

CA6...

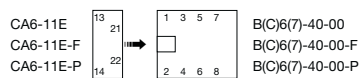

2XAX212011000012

B(C)6(7)-40-00
B(C)6(7)-40-00-F
B(C)6(7)-40-00-P

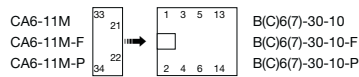

2XAX212012000012

B(C)6(7)-30-10
B(C)6(7)-30-10-F
B(C)6(7)-30-10-P

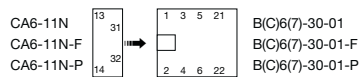

2XAX212013000012

B(C)6(7)-30-01
B(C)6(7)-30-01-F
B(C)6(7)-30-01-P

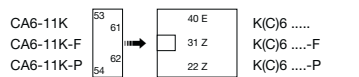

2XAX212014000012

K(C)6
K(C)6-F
K(C)6-P

CAF...

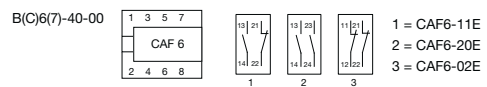

2XAX212015000012

1 = CAF6-11E
2 = CAF6-20E
3 = CAF6-02E

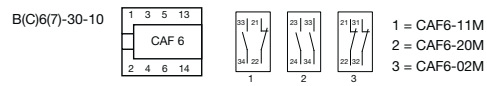

2XAX212016000012

1 = CAF6-11M
2 = CAF6-20M
3 = CAF6-02M

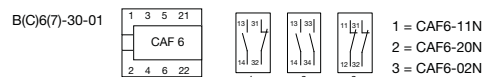

2XAX212017000012

1 = CAF6-11N
2 = CAF6-20N
3 = CAF6-02N

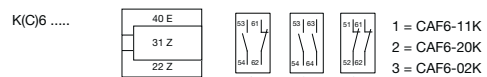

2XAX212018000012

1 = CAF6-11K
2 = CAF6-20K
3 = CAF6-02K

Mini contactors and contactor relays

Dimension drawings with accessories

Main dimensions mm, inches

Front mounted auxiliary contact blocks, with screw terminals

3

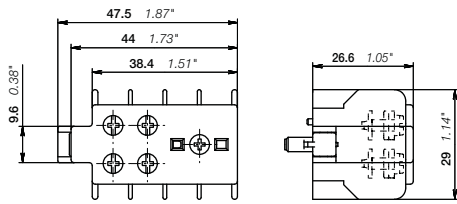

CAF6

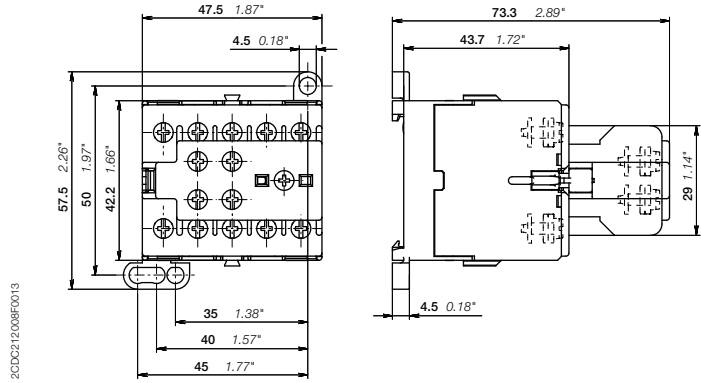

Mini contactors or contactor relays + CAF6

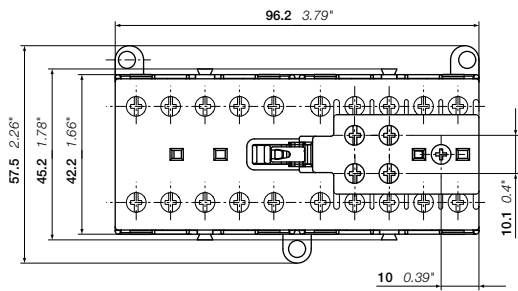

Mini reversing contactors + CAF6 (max. 2 contact blocks)

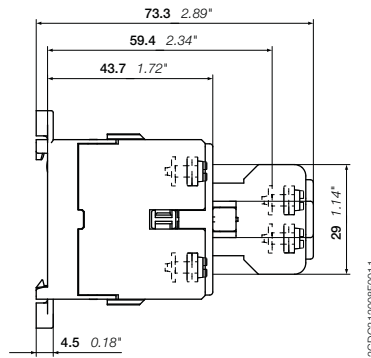

Side mounted auxiliary contact blocks, with screw terminals

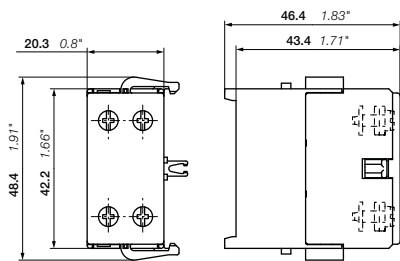

CA6-11E, CA6-11M, CA6-11N

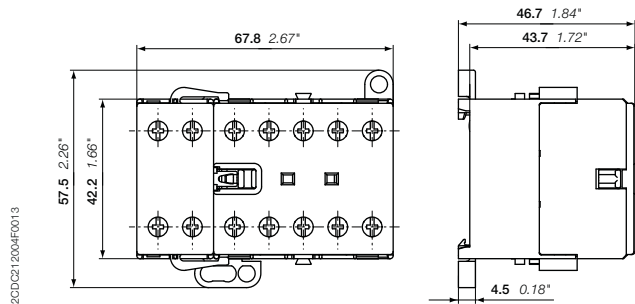

Mini contactors or contactor relays + CA6-11E, CA6-11M, CA6-11N

Mini contactors and contactor relays

Dimension drawings with accessories

Main dimensions mm, inches

Side mounted auxiliary contact blocks, with soldering pins

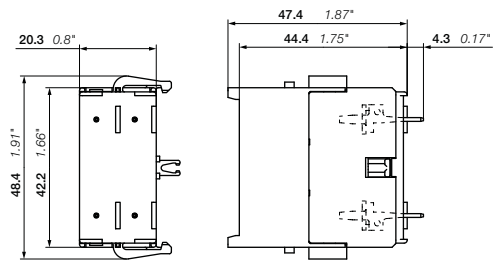

CA6-11E-P, CA6-11M-P, CA6-11N-P

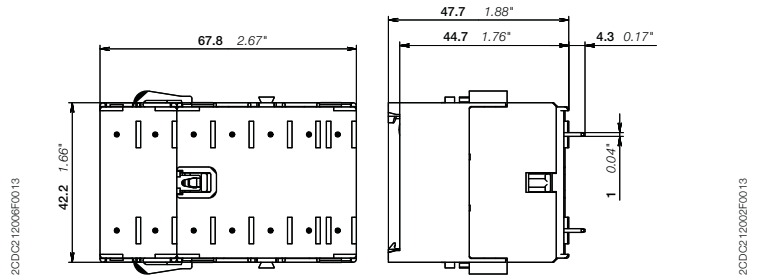

Mini contactors or contactor relays + CA6-11E-P, CA6-11M-P, CA6-11N-P

Side mounted auxiliary contact blocks, with flat pin connection

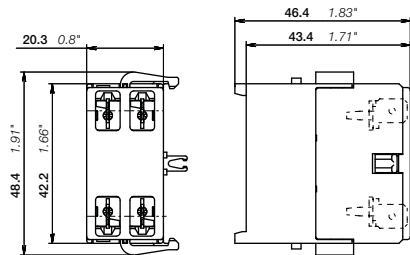

CA6-11E-F, CA6-11M-F, CA6-11N-F

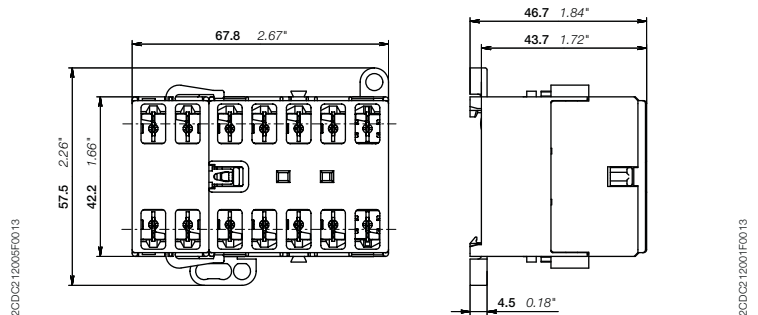

Mini contactors or contactor relays + CA6-11E-F, CA6-11M-F, CA6-11N-F

Front mounted cover cap for DIN rail panel installation

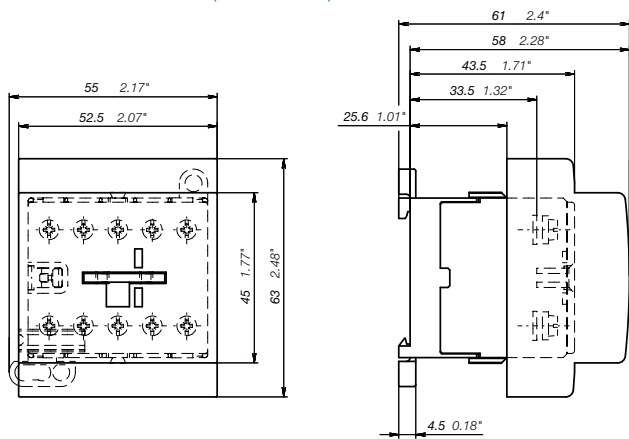

Mini contactors or contactor relays + LT6-B cover cap

Mini contactors and contactor relays

Dimension drawings with accessories

Main dimensions mm, inches

Drilling plans for wall mounting

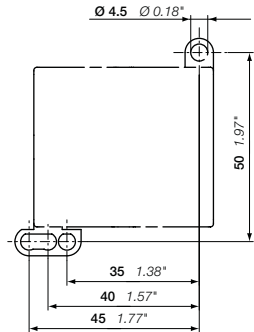

Mini contactors or contactor relays with screw terminals and flat pin connection

2CDC212008FD011

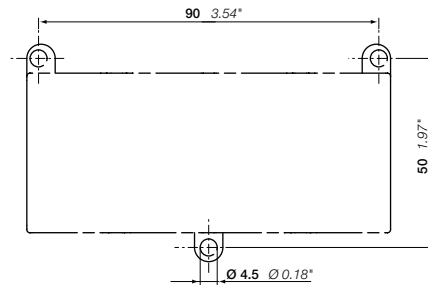

Mini reversing contactors with screw terminals and flat pin connection

2CDC212011FD011

Drilling plans for PCBA

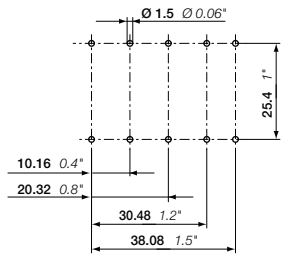

Mini contactors or contactor relays with soldering pins

2CDC212010FD011

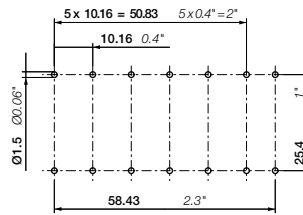

Mini contactors or contactor relays with soldering pins + CA6-11E-P, CA6-11M-P, CA6-11N-P

2CDC212001FD013

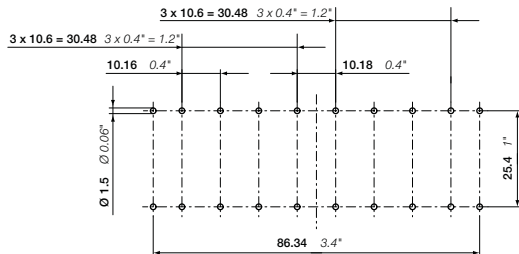

Mini reversing contactors with soldering pins

2CDC212012FD011

Notes

A series of horizontal dotted lines for taking notes, spanning most of the page width.



AS contactors and NS contactor relays with screw terminals

[Overview](#) 4/2

[Motor starting solutions - open type version, in kit form
with screw terminals](#) 4/5

[3-pole contactors and contactor relays with screw terminals](#) 4/29

[Voltage code table](#) 4/84

Compact Optimize your equipment dimensions!

One frame size for contactors up to 7.5 kW - 400 V

Same dimensions

for AC and DC operated contactors with screw or spring terminals

4

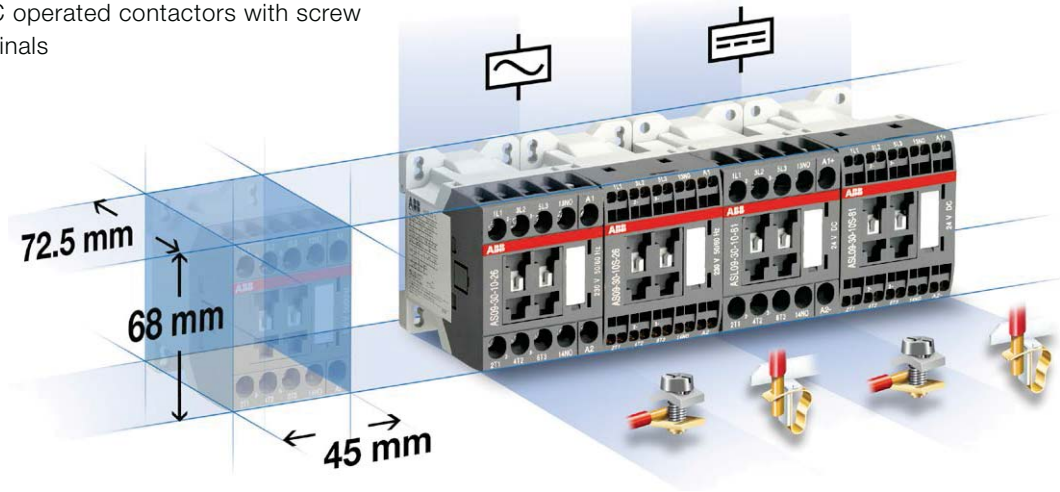

Reversing contactors

including mechanical and electrical interlocking without additional width

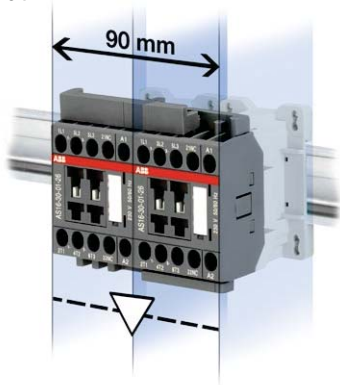

Direct control by PLC

removing any use of interface relay and reducing panel power consumption

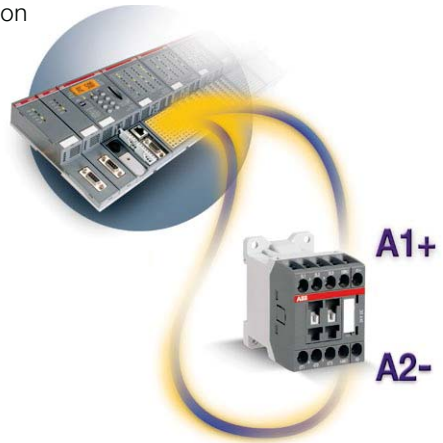

Side clipped-on surge suppressors

integrated into overall contactor dimensions allowing free access to coil terminals

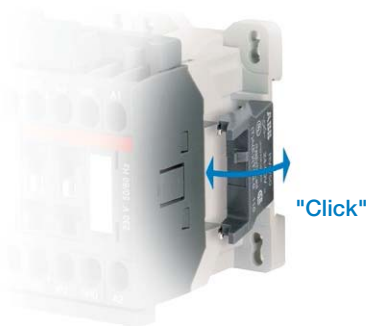

Multiple packaging available for all products



Simple

Choose reliable and time-saving solutions

Select compact starters:

- Direct-on-line and reversing starters up to 7.5 kW – 400 V
- Star-delta starters up to 11 KW – 400 V.

Protect your motors against short-circuits and overloads

- Type 1 or type 2 coordination guaranteed between contactors and short-circuit protection devices (manual motor starters or fuses)



Time/cost saving solutions with

- Connection sets for reversing and star-delta starter
- Easy, fast and secure assembly, fitting and wiring of components
- Direct 35 mm rail mounting: no additional mounting plate required
- Easy installation and dismantling of contactors: no unwiring of manual motor starters.



Compliant to International standards
Complies with RoHS European directives



Make your control circuits safe



High reliability
for low signals



Mechanically linked
contacts according to
IEC 60947-5-1
Annex L 3.0



Mirror contact
according to
IEC 60947-4-1
Annex F 2.1

Time and space-saving solutions, suitable for your applications

- Escalators
- Elevators
- Conveyors
- Compressors
- Door control
- Hvac
- Pumps
- Washing machines...





Motor starting solutions

Open type version, in kit form with screw terminals

Starters protected by manual motor starters

Overview	4/6
Direct-on-line starters	4/8
Reversing starters	4/12
Dimensions	4/16

Starters protected by thermal overload relays

Overview	4/18
Direct-on-line and reversing starters	4/20
Star-delta starters	4/22
Dimensions	4/26

Motor starting solutions

Open type version, in kit form

Starters protected by manual motor starters

Direct-on-line starters

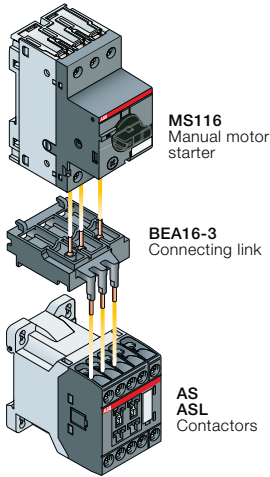
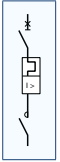

Reversing starters

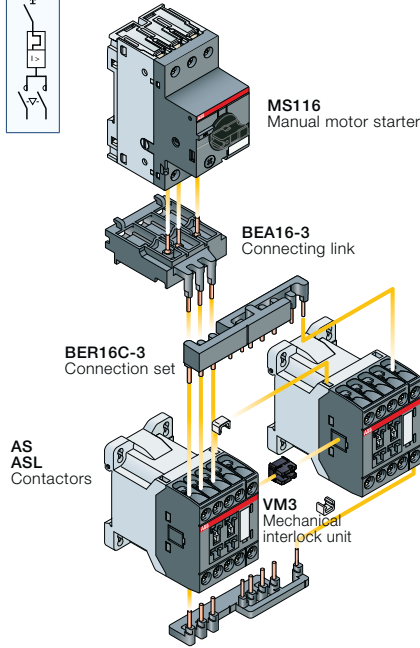
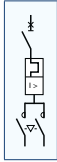

Starters protected by thermal overload relays

Direct-on-line starters

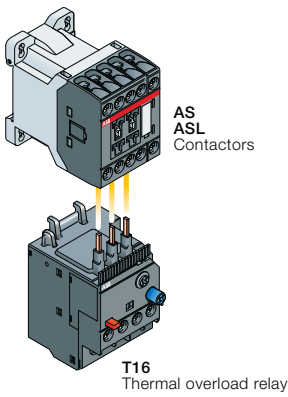

Reversing starters

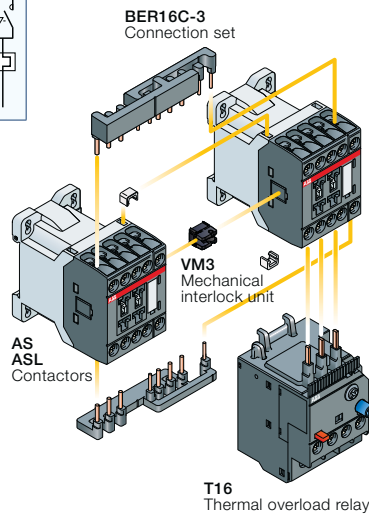

Star-delta starters

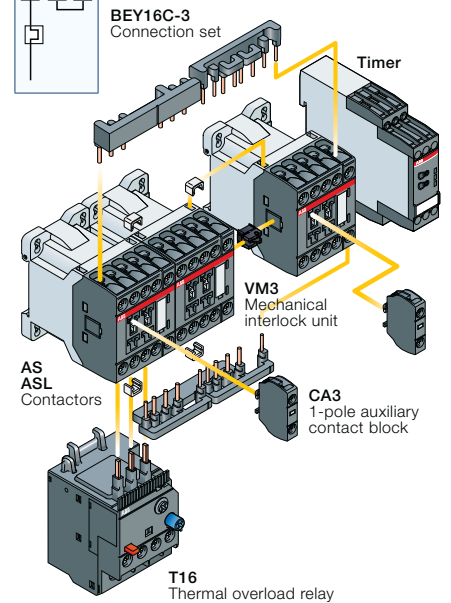
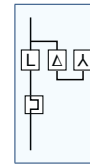

Starters protected by manual motor starters



Switching of 3-phase cage motors		Direct-on-line starters	Reversing starters
Rated power - AC-3, 400 V		0.06...7.5 kW	0.06...7.5 kW
Short-circuit current I _q		16 kA - 50 kA	16 kA - 50 kA
Coordination type		Type 1 & type 2	Type 1 & type 2
Manual motor starters		MS116	MS116
Contactors	AC operated	AS09 ... AS16	AS09 ... AS16
	DC operated	ASL09 ... ASL16	ASL09 ... ASL16

4

Starters protected by thermal overload relays



Switching of 3-phase cage motors		Direct-on-line starters	Reversing starters
Rated power - AC-3, 400 V		4...7.5 kW	4...7.5 kW
Contactors	AC operated	AS09 ... AS16	AS09 ... AS16
	DC operated	ASL09 ... ASL16	ASL09 ... ASL16
Thermal overload relays		T16	T16



Switching of 3-phase cage motors		Star-delta starters
Rated power - AC-3, 400 V		7.5...11 kW
Contactors	AC operated	AS09 ... AS16
	DC operated	ASL09 ... ASL16
Thermal overload relays		T16

1SEC101271S0201

Direct-on-line starters protected by manual motor starters

With AS, ASL contactors - open type version in kit form

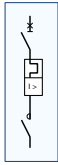
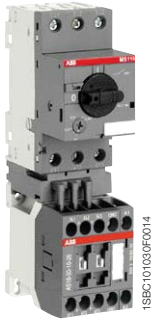

Application

Full voltage direct-on-line starting for controlling three-phase asynchronous motors is a simple and economic solution characterised by a high starting torque (1.9 to 2.1 times full-speed torque) and a starting current 5.5 to 7 times nominal current.

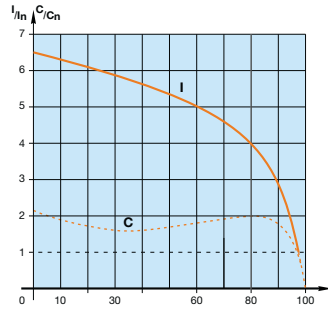

I = current
C = torque
In = nominal current
Cn = nominal torque

MS116 + BEA16-3 + AS16-30-10

Coordination types

The contactor and the manual motor starter control and protect motors against overload and short-circuits according to coordination types 1 and 2 (IEC 60947-4-1 / EN 60947-4-1) defining the anticipated level of service continuity as follow:

Type 1: In short-circuit conditions, the contactor or starter does not endanger persons or installations and will not be able to then operate without being repaired or having parts replaced.

Type 2: In short-circuit conditions, the contactor or starter does not endanger persons or installations and will be able to operate afterwards. The risk of contacts light welding is acceptable.

Main technical data

Standards	IEC 60947-4-1 / EN 60947-4-1
Rated operational voltage Ue max.	690 V - 50/60 Hz
Rated insulation voltage Ui according to IEC 60947-4-1	690 V
Switching frequency	≤ 15 starts/hour - 80 % max. load factor - with max. 1.5 s starting time ≤ 30 starts/hour - 50 % max. load factor - with max. 1.5 s starting time
Ambient air temperature close to the device	≤ 55 °C
Degree of protection	IP20

Mounting positions

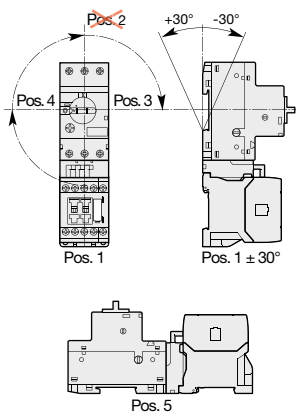

Direct-on-line starters protected by manual motor starters

With AS, ASL contactors - open type version in kit form

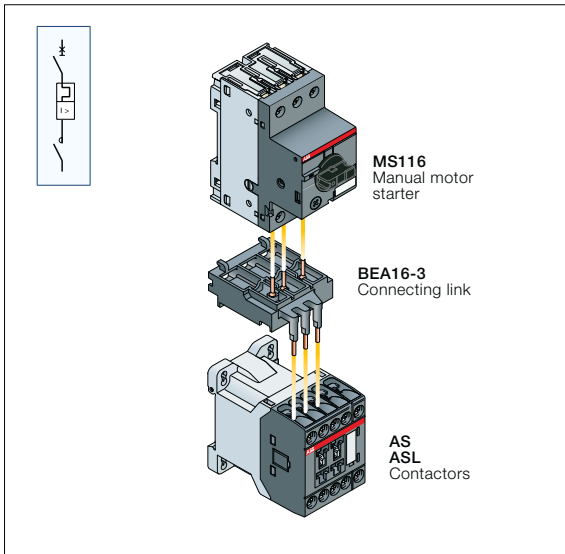

Description

You can easily assemble a direct-on-line starter by using the BEA16-3 connecting link 3-pole insulated. It is used to electrically and mechanically connect MS116 manual motor starter and AS or ASL contactors.

Select now easily and quickly your starter in the following pages for coordination type 1 or 2 at 400 V, 50 / 60 Hz, I_q = 16 kA or I_q = 50 kA up to 7.5 kW.

For complete coordination tables with MS116 or MS132, please contact your ABB local sales organization.

Wiring diagrams

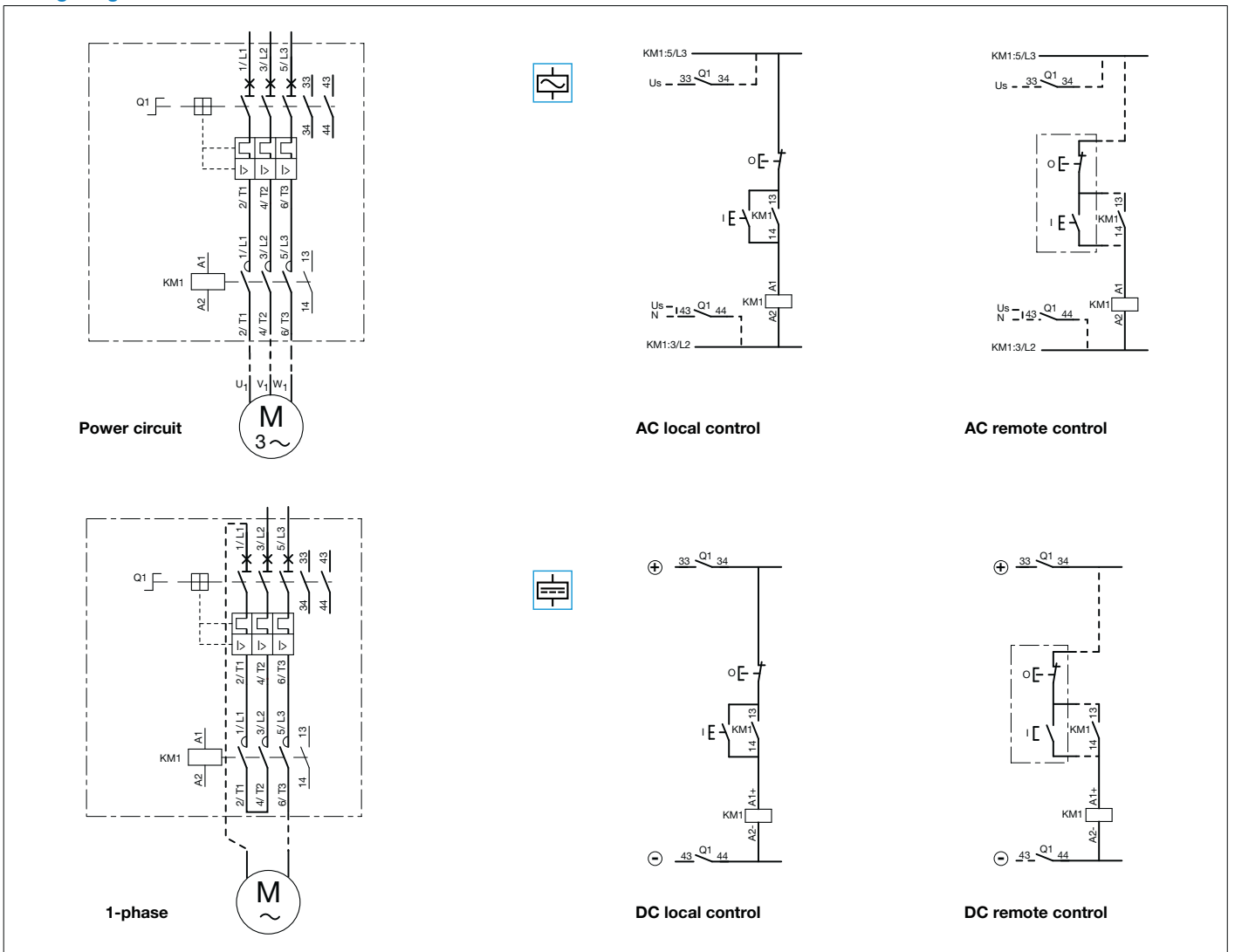

DOL starters protected by MS116 manual motor starters

With AS contactors - open type version in kit form

Coordination type 1 or type 2, AC-3, 16 kA or 50 kA, 400 V, 50/60 Hz

IEC AC-3, 400 V Rated operational power kW	Rated operational current A	Manual motor starters		Current setting range A	Magnetic tripping current A	Contactors		Type	Order code	Allowed setting current A
		Type	Order code			Rated control circuit voltage Uc (1) V 50 Hz	V 60 Hz			

Coordination type 1

Coordination type 2

I_q = 16 kA

I_q = 50 kA

0.06	0.2	MS116-0.25	1SAM250000R1002	0.16...0.25	2.44	24 230	24 230	AS09-30-10-20 AS09-30-10-26	1SBL101001R2010 1SBL101001R2610	0.25
0.09	0.3	MS116-0.4	1SAM250000R1003	0.25...0.40	3.9	24 230	24 230	AS09-30-10-20 AS09-30-10-26	1SBL101001R2010 1SBL101001R2610	0.4
0.12	0.44	MS116-0.63	1SAM250000R1004	0.40...0.63	6.14	24 230	24 230	AS09-30-10-20 AS09-30-10-26	1SBL101001R2010 1SBL101001R2610	0.63
0.18	0.6	MS116-1.0	1SAM250000R1005	0.63...1.00	11.5	24 230	24 230	AS09-30-10-20 AS09-30-10-26	1SBL101001R2010 1SBL101001R2610	1
0.25	0.85	MS116-1.0	1SAM250000R1005	0.63...1.00	11.5	24 230	24 230	AS09-30-10-20 AS09-30-10-26	1SBL101001R2010 1SBL101001R2610	1
0.37	1.1	MS116-1.6	1SAM250000R1006	1.00...1.60	18.4	24 230	24 230	AS09-30-10-20 AS09-30-10-26	1SBL101001R2010 1SBL101001R2610	1.6
0.55	1.5	MS116-1.6	1SAM250000R1006	1.00...1.60	18.4	24 230	24 230	AS09-30-10-20 AS09-30-10-26	1SBL101001R2010 1SBL101001R2610	1.6
0.75	1.9	MS116-2.5	1SAM250000R1007	1.60...2.50	28.75	24 230	24 230	AS09-30-10-20 AS09-30-10-26	1SBL101001R2010 1SBL101001R2610	2.5
1.1	2.7	MS116-4.0	1SAM250000R1008	2.50...4.00	50	24 230	24 230	AS09-30-10-20 AS09-30-10-26	1SBL101001R2010 1SBL101001R2610	4
1.5	3.6	MS116-4.0	1SAM250000R1008	2.50...4.00	50	24 230	24 230	AS09-30-10-20 AS09-30-10-26	1SBL101001R2010 1SBL101001R2610	4
2.2	4.9	MS116-6.3	1SAM250000R1009	4.00...6.30	78.75	24 230	24 230	AS09-30-10-20 AS09-30-10-26	1SBL101001R2010 1SBL101001R2610	6.3
3	6.5	MS116-10	1SAM250000R1010	6.30...10.0	150	24 230	24 230	AS12-30-10-20 AS12-30-10-26	1SBL111001R2010 1SBL111001R2610	10
4	8.5	MS116-10	1SAM250000R1010	6.30...10.0	150	24 230	24 230	AS12-30-10-20 AS12-30-10-26	1SBL111001R2010 1SBL111001R2610	10
5.5	11.5	MS116-12	1SAM250000R1012	8.00...12.0	180	24 230	24 230	AS12-30-10-20 AS12-30-10-26	1SBL111001R2010 1SBL111001R2610	12
7.5	15.5	MS116-16	1SAM250000R1011	10.0...16.0	240	24 230	24 230	AS16-30-10-20 AS16-30-10-26	1SBL121001R2010 1SBL121001R2610	15.5

Note: for multiple packaging, please contact your ABB local sales organization.

(1) Other control voltages see voltage code table.



Main accessories

Connecting link for manual motor starter

Type

BEA16-3

Order code

1SBN081006T1000

DOL starters protected by MS116 manual motor starters With ASL contactors - open type version in kit form

Coordination type 1 or type 2, AC-3, 16 or 50 kA, 400 V, 50/60 Hz

IEC AC-3, 400 V Rated operational power kW	IEC Rated operational current A	Manual motor starters				Contactors				
		Type	Order code	Current setting range A	Magnetic tripping current A	Rated control voltage Uc (1) V DC	Type	Order code	Allowed setting current A	
Coordination type 1										
Coordination type 2										
0.06	0.2	MS116-0.25	1SAM250000R1002	0.16...0.25	2.44	24	ASL09-30-10-81	1SBL103001R8110	0.25	
0.09	0.3	MS116-0.4	1SAM250000R1003	0.25...0.40	3.9	24	ASL09-30-10-81	1SBL103001R8110	0.4	
0.12	0.44	MS116-0.63	1SAM250000R1004	0.40...0.63	6.14	24	ASL09-30-10-81	1SBL103001R8110	0.63	
0.18	0.6	MS116-1.0	1SAM250000R1005	0.63...1.00	11.5	24	ASL09-30-10-81	1SBL103001R8110	1	
0.25	0.85	MS116-1.0	1SAM250000R1005	0.63...1.00	11.5	24	ASL09-30-10-81	1SBL103001R8110	1	
0.37	1.1	MS116-1.6	1SAM250000R1006	1.00...1.60	18.4	24	ASL09-30-10-81	1SBL103001R8110	1.6	
0.55	1.5	MS116-1.6	1SAM250000R1006	1.00...1.60	18.4	24	ASL09-30-10-81	1SBL103001R8110	1.6	
0.75	1.9	MS116-2.5	1SAM250000R1007	1.60...2.50	28.75	24	ASL09-30-10-81	1SBL103001R8110	2.5	
1.1	2.7	MS116-4.0	1SAM250000R1008	2.50...4.00	50	24	ASL09-30-10-81	1SBL103001R8110	4	
1.5	3.6	MS116-4.0	1SAM250000R1008	2.50...4.00	50	24	ASL09-30-10-81	1SBL103001R8110	4	
2.2	4.9	MS116-6.3	1SAM250000R1009	4.00...6.30	78.75	24	ASL09-30-10-81	1SBL103001R8110	6.3	
3	6.5	MS116-10	1SAM250000R1010	6.30...10.0	150	24	ASL12-30-10-81	1SBL113001R8110	10	
4	8.5	MS116-10	1SAM250000R1010	6.30...10.0	150	24	ASL12-30-10-81	1SBL113001R8110	10	
5.5	11.5	MS116-12	1SAM250000R1012	8.00...12.0	180	24	ASL12-30-10-81	1SBL113001R8110	12	
7.5	15.5	MS116-16	1SAM250000R1011	10.0...16.0	240	24	ASL16-30-10-81	1SBL123001R8110	15.5	

Note: for multiple packaging, please contact your ABB local sales organization.

(1) Other control voltages see voltage code table.



Main accessories

Connecting link for manual motor starter

Type

BEA16-3

Order code

1SBN081006T1000

Reversing starters protected by manual motor starters

With AS, ASL contactors - open type version in kit form

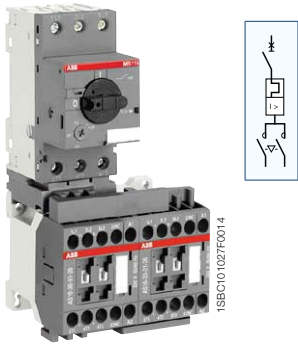

4

MS116 + BEA16-3 + VM3 +
BER16C-3 + AS16-30-01

Application

Full voltage reversing starting for controlling three-phase asynchronous motors is a simple and economic solution characterised by a high starting torque (1.9 to 2.1 times full-speed torque) and a starting current 5.5 to 7 times nominal current.

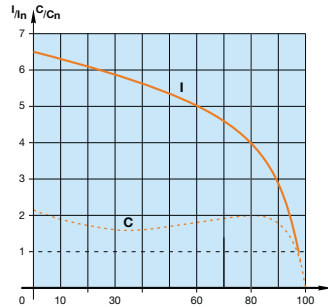

I = current
C = torque
In = nominal current
Cn = nominal torque

Coordination types

The contactor and the manual motor starter control and protect motors against overload and short-circuits according to coordination types 1 and 2 (IEC 60947-4-1 / EN 60947-4-1) defining the anticipated level of service continuity as follow:

Type 1: In short-circuit conditions, the contactor or starter does not endanger persons or installations and will not be able to then operate without being repaired or having parts replaced.

Type 2: In short-circuit conditions, the contactor or starter does not endanger persons or installations and will be able to operate afterwards. The risk of contacts light welding is acceptable.

Main technical data

Standards	IEC 60947-4-1 / EN 60947-4-1
Rated operational voltage Ue max.	690 V - 50/60 Hz
Rated insulation voltage Ui according to IEC 60947-4-1	690 V
Switching frequency	≤ 15 starts/hour - 80 % max. load factor - with max. 1.5 s starting time ≤ 30 starts/hour - 50 % max. load factor - with max. 1.5 s starting time
Ambient air temperature close to the device	≤ 55 °C
Degree of protection	IP20

Note: Minimum switchover delay of 50 ms must be introduced between respective opening and closing of AC operated reversing contactors

Mounting positions

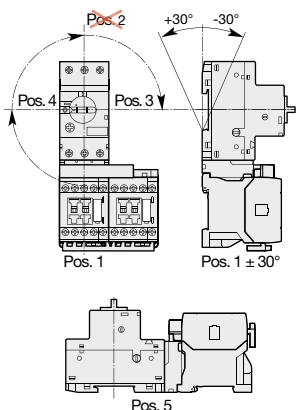

Reversing starters protected by manual motor starters

With AS, ASL contactors - open type version in kit form

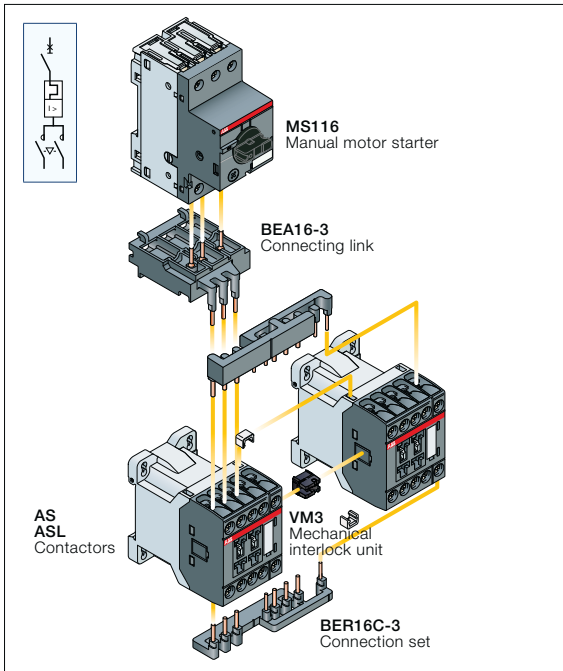

Description

You can easily assemble reversing starter thanks to our complete range of accessories:

- BEA16-3 connecting link 3-pole insulated: it is used to electrically and mechanically connect MS116 manual motor starter and AS or ASL contactors.
- VM3 mechanical interlock unit: just clip it between the 2 contactors without increasing starter width.
- BER16C-3 connection set: it assures a safe and simple connection between both contactor main terminals and an electrical interlocking between coil and N.C. built-in auxiliary contact terminals of both contactors.

Select now easily and quickly your starter in the following pages for coordination type 1 or 2 at 400 V, 50 / 60 Hz, I_q = 16 kA or I_q = 50 kA up to 7.5 kW.

For complete coordination tables with MS116 or MS132, please contact your ABB local sales organization.

Wiring diagrams

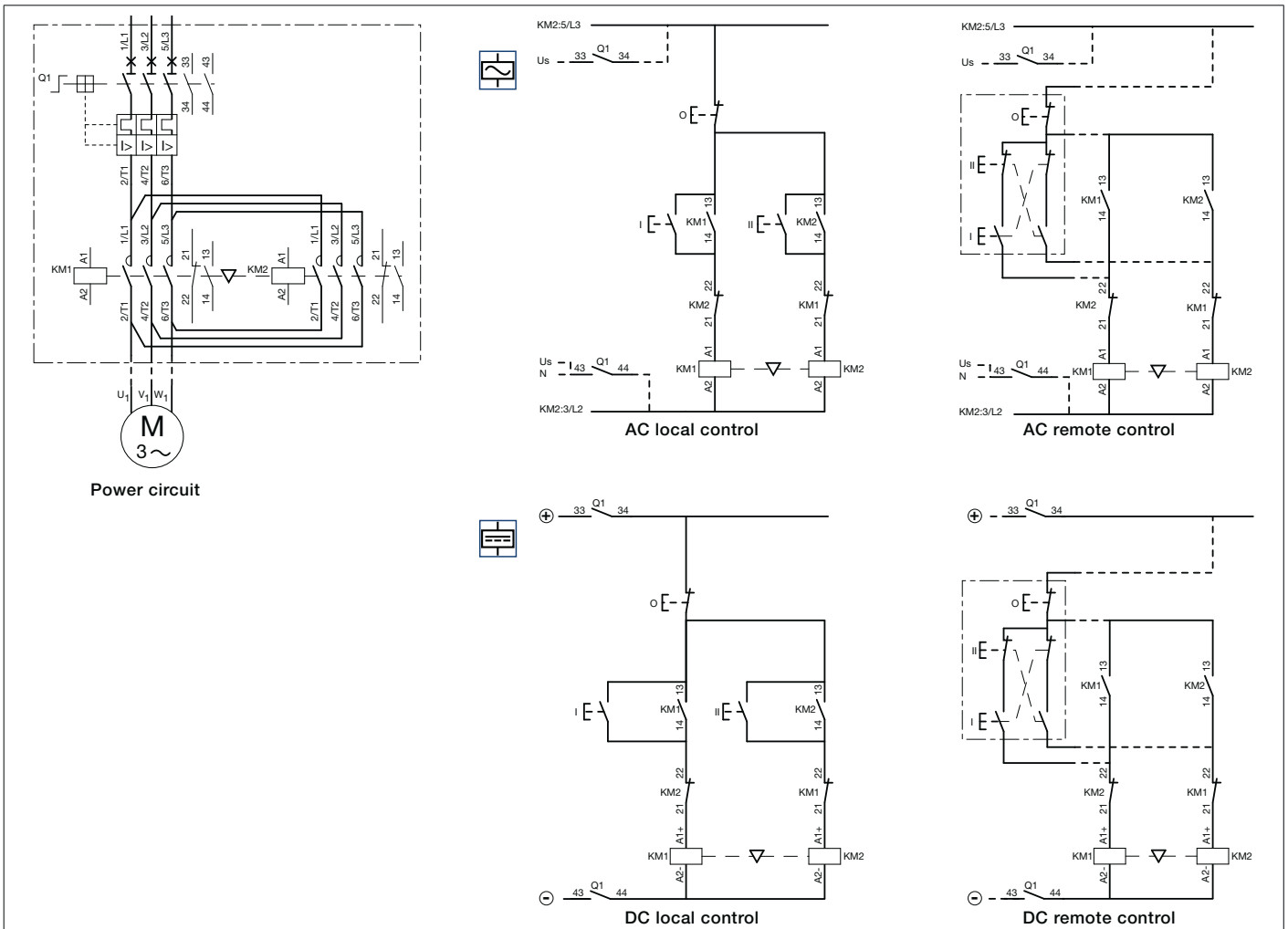

Reversing starters protected by MS116 manual motor starters

With AS contactors - open type version in kit form

Coordination type 1 or type 2, AC-3, 16 kA or 50 kA, 400 V, 50/60 Hz

IEC AC-3, 400 V Rated operational power kW	Type	Manual motor starters		Current setting range A	Magnetic tripping current A	Contactors		Type	Order code	Allowed setting current A	
		Type	Order code			Rated control circuit voltage Uc (1) V 50 Hz	V 60 Hz				
<p>Coordination type 1</p> <p>Coordination type 2</p> <p>Iq = 16 kA</p> <p>Iq = 50 kA</p>	0.06	0.2	MS116-0.25	1SAM250000R1002	0.16...0.25	2.44	24	24	AS09-30-01-20	1SBL101001R2001	0.25
							230	230	AS09-30-01-26	1SBL101001R2601	
	0.09	0.3	MS116-0.4	1SAM250000R1003	0.25...0.40	3.9	24	24	AS09-30-01-20	1SBL101001R2001	0.4
							230	230	AS09-30-01-26	1SBL101001R2601	
	0.12	0.44	MS116-0.63	1SAM250000R1004	0.40...0.63	6.14	24	24	AS09-30-01-20	1SBL101001R2001	0.63
							230	230	AS09-30-01-26	1SBL101001R2601	
	0.18	0.6	MS116-1.0	1SAM250000R1005	0.63...1.00	11.5	24	24	AS09-30-01-20	1SBL101001R2001	1
							230	230	AS09-30-01-26	1SBL101001R2601	
	0.25	0.85	MS116-1.0	1SAM250000R1005	0.63...1.00	11.5	24	24	AS09-30-01-20	1SBL101001R2001	1
							230	230	AS09-30-01-26	1SBL101001R2601	
	0.37	1.1	MS116-1.6	1SAM250000R1006	1.00...1.60	18.4	24	24	AS09-30-01-20	1SBL101001R2001	1.6
							230	230	AS09-30-01-26	1SBL101001R2601	
	0.55	1.5	MS116-1.6	1SAM250000R1006	1.00...1.60	18.4	24	24	AS09-30-01-20	1SBL101001R2001	1.6
							230	230	AS09-30-01-26	1SBL101001R2601	
	0.75	1.9	MS116-2.5	1SAM250000R1007	1.60...2.50	28.75	24	24	AS09-30-01-20	1SBL101001R2001	2.5
							230	230	AS09-30-01-26	1SBL101001R2601	
1.1	2.7	MS116-4.0	1SAM250000R1008	2.50...4.00	50	24	24	AS09-30-01-20	1SBL101001R2001	4	
						230	230	AS09-30-01-26	1SBL101001R2601		
1.5	3.6	MS116-4.0	1SAM250000R1008	2.50...4.00	50	24	24	AS09-30-01-20	1SBL101001R2001	4	
						230	230	AS09-30-01-26	1SBL101001R2601		
2.2	4.9	MS116-6.3	1SAM250000R1009	4.00...6.30	78.75	24	24	AS09-30-01-20	1SBL101001R2001	6.3	
						230	230	AS09-30-01-26	1SBL101001R2601		
3	6.5	MS116-10	1SAM250000R1010	6.30...10.0	150	24	24	AS12-30-01-20	1SBL111001R2001	10	
						230	230	AS12-30-01-26	1SBL111001R2601		
4	8.5	MS116-10	1SAM250000R1010	6.30...10.0	150	24	24	AS12-30-01-20	1SBL111001R2001	10	
						230	230	AS12-30-01-26	1SBL111001R2601		
5.5	11.5	MS116-12	1SAM250000R1012	8.00...12.0	180	24	24	AS12-30-01-20	1SBL111001R2001	12	
						230	230	AS12-30-01-26	1SBL111001R2601		
7.5	15.5	MS116-16	1SAM250000R1011	10.0...16.0	240	24	24	AS16-30-01-20	1SBL121001R2001	15.5	
						230	230	AS16-30-01-26	1SBL121001R2601		

Note: for multiple packaging, please contact your ABB local sales organization.

(1) Other control voltages see voltage code table.

Main accessories		Type	Order code
	Connecting link for manual motor starter	BEA16-3	1SBN081006T1000
	Connection set for reversing starter	BER16C-3	1SBN081012R1000
	Mechanical interlock unit	VM3	1SBN031005T1000

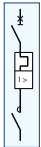

Reversing starters protected by MS116 manual motor starters With ASL contactors - open type version in kit form

Coordination type 1 or type 2, AC-3, 16 or 50 kA, 400 V, 50/60 Hz

IEC AC-3, 400 V Rated operational power kW	A	Manual motor starters				Contactors																																																																																																																																																																					
		Type	Order code	Current setting range A	Magnetic tripping current A	Rated control circuit voltage U _c (1) V DC	Type	Order code	Allowed setting current A																																																																																																																																																																		
																																																																																																																																																																											
<div style="display: flex; justify-content: space-between;"> <div style="width: 45%;"> <p>Coordination type 1</p> <p>Coordination type 2</p> <p style="color: orange;">I_q = 16 kA</p> <p style="color: orange;">I_q = 50 kA</p> </div> <div style="width: 50%;"> <table border="1"> <thead> <tr> <th>Rated operational power (kW)</th> <th>Rated operational current (A)</th> <th>Manual motor starter Type</th> <th>Manual motor starter Order code</th> <th>Current setting range (A)</th> <th>Magnetic tripping current (A)</th> <th>Rated control circuit voltage U_c (1) (V DC)</th> <th>Contactors Type</th> <th>Contactors Order code</th> <th>Allowed setting current (A)</th> </tr> </thead> <tbody> <tr><td>0.06</td><td>0.2</td><td>MS116-0.25</td><td>1SAM250000R1002</td><td>0.16...0.25</td><td>2.44</td><td>24</td><td>ASL09-30-01-81</td><td>1SBL103001R8101</td><td>0.25</td></tr> <tr><td>0.09</td><td>0.3</td><td>MS116-0.4</td><td>1SAM250000R1003</td><td>0.25...0.40</td><td>3.9</td><td>24</td><td>ASL09-30-01-81</td><td>1SBL103001R8101</td><td>0.4</td></tr> <tr><td>0.12</td><td>0.44</td><td>MS116-0.63</td><td>1SAM250000R1004</td><td>0.40...0.63</td><td>6.14</td><td>24</td><td>ASL09-30-01-81</td><td>1SBL103001R8101</td><td>0.63</td></tr> <tr><td>0.18</td><td>0.6</td><td>MS116-1.0</td><td>1SAM250000R1005</td><td>0.63...1.00</td><td>11.5</td><td>24</td><td>ASL09-30-01-81</td><td>1SBL103001R8101</td><td>1</td></tr> <tr><td>0.25</td><td>0.85</td><td>MS116-1.0</td><td>1SAM250000R1005</td><td>0.63...1.00</td><td>11.5</td><td>24</td><td>ASL09-30-01-81</td><td>1SBL103001R8101</td><td>1</td></tr> <tr><td>0.37</td><td>1.1</td><td>MS116-1.6</td><td>1SAM250000R1006</td><td>1.00...1.60</td><td>18.4</td><td>24</td><td>ASL09-30-01-81</td><td>1SBL103001R8101</td><td>1.6</td></tr> <tr><td>0.55</td><td>1.5</td><td>MS116-1.6</td><td>1SAM250000R1006</td><td>1.00...1.60</td><td>18.4</td><td>24</td><td>ASL09-30-01-81</td><td>1SBL103001R8101</td><td>1.6</td></tr> <tr><td>0.75</td><td>1.9</td><td>MS116-2.5</td><td>1SAM250000R1007</td><td>1.60...2.50</td><td>28.75</td><td>24</td><td>ASL09-30-01-81</td><td>1SBL103001R8101</td><td>2.5</td></tr> <tr><td>1.1</td><td>2.7</td><td>MS116-4.0</td><td>1SAM250000R1008</td><td>2.50...4.00</td><td>50</td><td>24</td><td>ASL09-30-01-81</td><td>1SBL103001R8101</td><td>4</td></tr> <tr><td>1.5</td><td>3.6</td><td>MS116-4.0</td><td>1SAM250000R1008</td><td>2.50...4.00</td><td>50</td><td>24</td><td>ASL09-30-01-81</td><td>1SBL103001R8101</td><td>4</td></tr> <tr><td>2.2</td><td>4.9</td><td>MS116-6.3</td><td>1SAM250000R1009</td><td>4.00...6.30</td><td>78.75</td><td>24</td><td>ASL09-30-01-81</td><td>1SBL103001R8101</td><td>6.3</td></tr> <tr><td>3</td><td>6.5</td><td>MS116-10</td><td>1SAM250000R1010</td><td>6.30...10.0</td><td>150</td><td>24</td><td>ASL12-30-01-81</td><td>1SBL113001R8101</td><td>10</td></tr> <tr><td>4</td><td>8.5</td><td>MS116-10</td><td>1SAM250000R1010</td><td>6.30...10.0</td><td>150</td><td>24</td><td>ASL12-30-01-81</td><td>1SBL113001R8101</td><td>10</td></tr> <tr><td>5.5</td><td>11.5</td><td>MS116-12</td><td>1SAM250000R1012</td><td>8.00...12.0</td><td>180</td><td>24</td><td>ASL12-30-01-81</td><td>1SBL113001R8101</td><td>12</td></tr> <tr><td>7.5</td><td>15.5</td><td>MS116-16</td><td>1SAM250000R1011</td><td>10.0...16.0</td><td>240</td><td>24</td><td>ASL16-30-01-81</td><td>1SBL123001R8101</td><td>15.5</td></tr> </tbody> </table> </div> </div>												Rated operational power (kW)	Rated operational current (A)	Manual motor starter Type	Manual motor starter Order code	Current setting range (A)	Magnetic tripping current (A)	Rated control circuit voltage U _c (1) (V DC)	Contactors Type	Contactors Order code	Allowed setting current (A)	0.06	0.2	MS116-0.25	1SAM250000R1002	0.16...0.25	2.44	24	ASL09-30-01-81	1SBL103001R8101	0.25	0.09	0.3	MS116-0.4	1SAM250000R1003	0.25...0.40	3.9	24	ASL09-30-01-81	1SBL103001R8101	0.4	0.12	0.44	MS116-0.63	1SAM250000R1004	0.40...0.63	6.14	24	ASL09-30-01-81	1SBL103001R8101	0.63	0.18	0.6	MS116-1.0	1SAM250000R1005	0.63...1.00	11.5	24	ASL09-30-01-81	1SBL103001R8101	1	0.25	0.85	MS116-1.0	1SAM250000R1005	0.63...1.00	11.5	24	ASL09-30-01-81	1SBL103001R8101	1	0.37	1.1	MS116-1.6	1SAM250000R1006	1.00...1.60	18.4	24	ASL09-30-01-81	1SBL103001R8101	1.6	0.55	1.5	MS116-1.6	1SAM250000R1006	1.00...1.60	18.4	24	ASL09-30-01-81	1SBL103001R8101	1.6	0.75	1.9	MS116-2.5	1SAM250000R1007	1.60...2.50	28.75	24	ASL09-30-01-81	1SBL103001R8101	2.5	1.1	2.7	MS116-4.0	1SAM250000R1008	2.50...4.00	50	24	ASL09-30-01-81	1SBL103001R8101	4	1.5	3.6	MS116-4.0	1SAM250000R1008	2.50...4.00	50	24	ASL09-30-01-81	1SBL103001R8101	4	2.2	4.9	MS116-6.3	1SAM250000R1009	4.00...6.30	78.75	24	ASL09-30-01-81	1SBL103001R8101	6.3	3	6.5	MS116-10	1SAM250000R1010	6.30...10.0	150	24	ASL12-30-01-81	1SBL113001R8101	10	4	8.5	MS116-10	1SAM250000R1010	6.30...10.0	150	24	ASL12-30-01-81	1SBL113001R8101	10	5.5	11.5	MS116-12	1SAM250000R1012	8.00...12.0	180	24	ASL12-30-01-81	1SBL113001R8101	12	7.5	15.5	MS116-16	1SAM250000R1011	10.0...16.0	240	24	ASL16-30-01-81	1SBL123001R8101	15.5
Rated operational power (kW)	Rated operational current (A)	Manual motor starter Type	Manual motor starter Order code	Current setting range (A)	Magnetic tripping current (A)	Rated control circuit voltage U _c (1) (V DC)	Contactors Type	Contactors Order code	Allowed setting current (A)																																																																																																																																																																		
0.06	0.2	MS116-0.25	1SAM250000R1002	0.16...0.25	2.44	24	ASL09-30-01-81	1SBL103001R8101	0.25																																																																																																																																																																		
0.09	0.3	MS116-0.4	1SAM250000R1003	0.25...0.40	3.9	24	ASL09-30-01-81	1SBL103001R8101	0.4																																																																																																																																																																		
0.12	0.44	MS116-0.63	1SAM250000R1004	0.40...0.63	6.14	24	ASL09-30-01-81	1SBL103001R8101	0.63																																																																																																																																																																		
0.18	0.6	MS116-1.0	1SAM250000R1005	0.63...1.00	11.5	24	ASL09-30-01-81	1SBL103001R8101	1																																																																																																																																																																		
0.25	0.85	MS116-1.0	1SAM250000R1005	0.63...1.00	11.5	24	ASL09-30-01-81	1SBL103001R8101	1																																																																																																																																																																		
0.37	1.1	MS116-1.6	1SAM250000R1006	1.00...1.60	18.4	24	ASL09-30-01-81	1SBL103001R8101	1.6																																																																																																																																																																		
0.55	1.5	MS116-1.6	1SAM250000R1006	1.00...1.60	18.4	24	ASL09-30-01-81	1SBL103001R8101	1.6																																																																																																																																																																		
0.75	1.9	MS116-2.5	1SAM250000R1007	1.60...2.50	28.75	24	ASL09-30-01-81	1SBL103001R8101	2.5																																																																																																																																																																		
1.1	2.7	MS116-4.0	1SAM250000R1008	2.50...4.00	50	24	ASL09-30-01-81	1SBL103001R8101	4																																																																																																																																																																		
1.5	3.6	MS116-4.0	1SAM250000R1008	2.50...4.00	50	24	ASL09-30-01-81	1SBL103001R8101	4																																																																																																																																																																		
2.2	4.9	MS116-6.3	1SAM250000R1009	4.00...6.30	78.75	24	ASL09-30-01-81	1SBL103001R8101	6.3																																																																																																																																																																		
3	6.5	MS116-10	1SAM250000R1010	6.30...10.0	150	24	ASL12-30-01-81	1SBL113001R8101	10																																																																																																																																																																		
4	8.5	MS116-10	1SAM250000R1010	6.30...10.0	150	24	ASL12-30-01-81	1SBL113001R8101	10																																																																																																																																																																		
5.5	11.5	MS116-12	1SAM250000R1012	8.00...12.0	180	24	ASL12-30-01-81	1SBL113001R8101	12																																																																																																																																																																		
7.5	15.5	MS116-16	1SAM250000R1011	10.0...16.0	240	24	ASL16-30-01-81	1SBL123001R8101	15.5																																																																																																																																																																		

Note: for multiple packaging, please contact your ABB local sales organization.

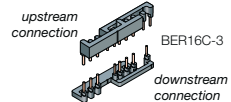
(1) Other control voltages see voltage code table.

Main accessories		Type	Order code
	Connecting link for manual motor starter	BEA16-3	1SBN081006T1000
	Connection set for reversing starter	BER16C-3	1SBN081012R1000
	Mechanical interlock unit	VM3	1SBN031005T1000

DOL starters protected by MS116 manual motor starters

With AS, ASL contactors - open type version in kit form

Main dimensions mm, inches

Direct-on-line starters

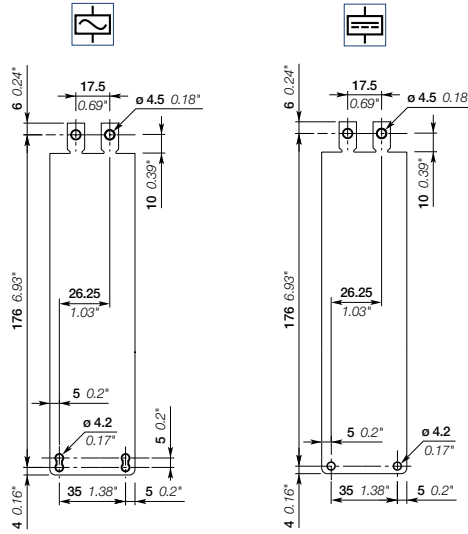
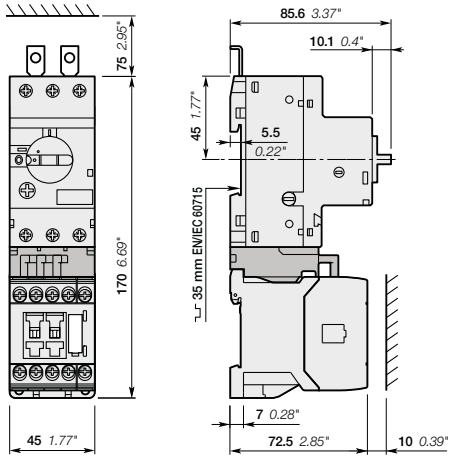

- MS116
- + BEA16-3
- + AS09, ASL09, AS12, ASL12, AS16, ASL16

Reversing starters protected by MS116 manual motor starters With AS, ASL contactors - open type version in kit form

Main dimensions mm, inches

Reversing starters

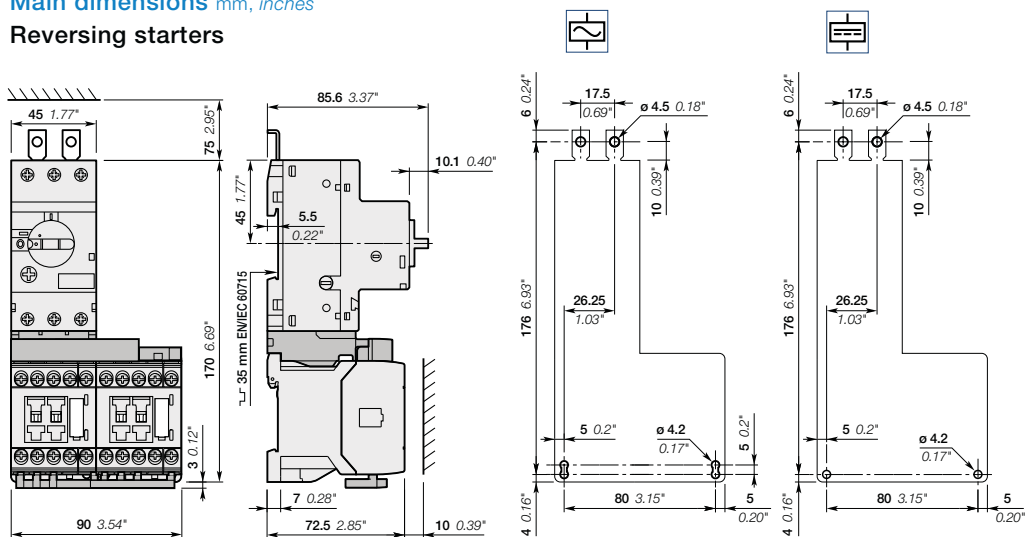

MS116

+ BEA16-3 + BER16C-3 + VM3

+ AS09, ASL09, AS12, ASL12, AS16, ASL16

DOL & reversing starters protected by thermal overload relays

With AS, ASL contactors - open type version in kit form

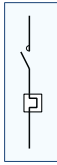

Application

Full voltage direct-on-line and reversing starting for controlling three-phase asynchronous motors is a simple and economic solution characterised by a high starting torque (1.9 to 2.1 times full-speed torque) and a starting current 5.5 to 7 times nominal current.

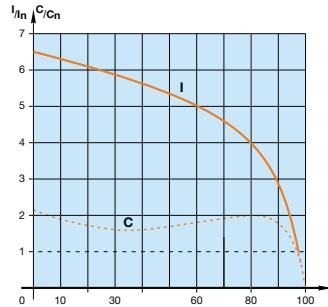

I = current
C = torque
 I_n = nominal current
 C_n = nominal torque

AS09-30-10 + T16

4



Coordination types

The contactor, the short-circuit protection device and the thermal overload relay control and protect motors against overload and short-circuits according to coordination types 1 and 2 (IEC 60947-4-1 / EN 60947-4-1) defining the anticipated level of service continuity as follow:

Type 1: In short-circuit conditions, the contactor or starter does not endanger persons or installations and will not be able to then operate without being repaired or having parts replaced.

Type 2: In short-circuit conditions, the contactor or starter does not endanger persons or installations and will be able to operate afterwards. The risk of contacts light welding is acceptable.

AS09-30-01 + BER16C + VM3 + T16

Main technical data

Standards	IEC 60947-4-1 / EN 60947-4-1
Rated operational voltage U_e max.	690 V - 50/60 Hz
Rated insulation voltage U_i according to IEC 60947-4-1	690 V
Air temperature close to the device	≤ 60 °C
Degree of protection	IP20

Switching frequency

Thermal overload relays cannot be operated at any arbitrary switching frequency in order to avoid tripping. Applications involving up to 15 operations per hour are acceptable. Higher switching frequencies are permitted if the duty ratio and the motor starting time are allowed for and if the motor's making current does not appreciably exceed 6 times the rated operating current. Please refer to the adjacent diagram for guideline values for the permitted switching frequency.

Example:

Starting time of the motor: 1 second Duty ratio: 40 % means a permitted switching frequency of max. 60 operating cycles per hour.

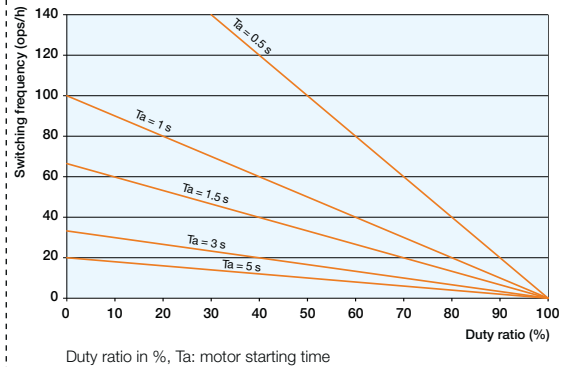

Note: Minimum switchover delay of 50 ms must be introduced between respective opening and closing of AC operated reversing contactors

Mounting positions

Direct-on-line

Reversing

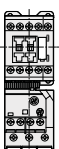

Pos. 1

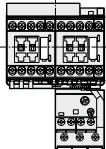

Pos. 1

DOL & reversing starters protected by thermal overload relays With AS, ASL contactors - open type version in kit form

Direct-on-line starters

Reversing starters

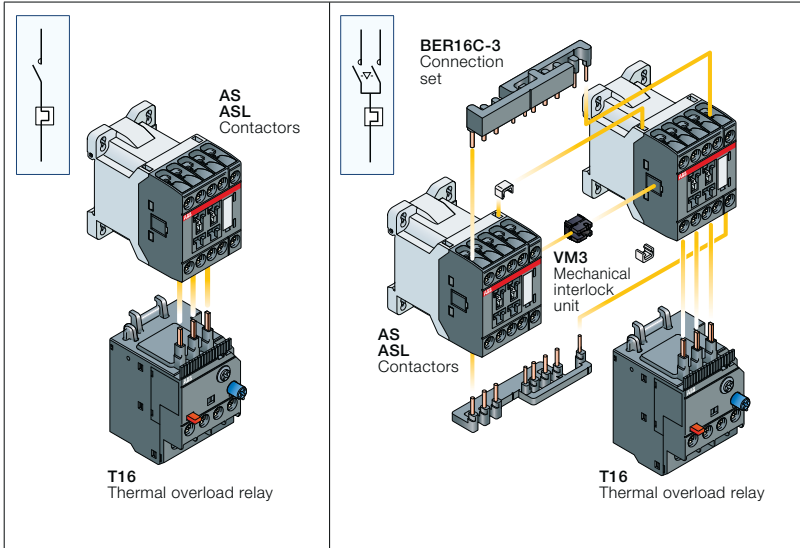

Description

You can easily assemble a direct-on-line starter by connecting AS or ASL contactors and T16 thermal overload relay.

You can easily assemble reversing starter thanks to our complete range of accessories:

- VM3 mechanical interlock unit: just clip it between the 2 contactors without increasing starter length.
- BER16C-3 connection set: it assures a safe and simple reversing connection between both contactor main terminals and an electrical interlocking between coil and N.C. built-in auxiliary contact terminals of both contactors.

Select now easily and quickly your starter in the following pages at 400 V, up to 7.5 kW.

For complete coordination tables, please contact your ABB local sales organization.

Wiring diagrams

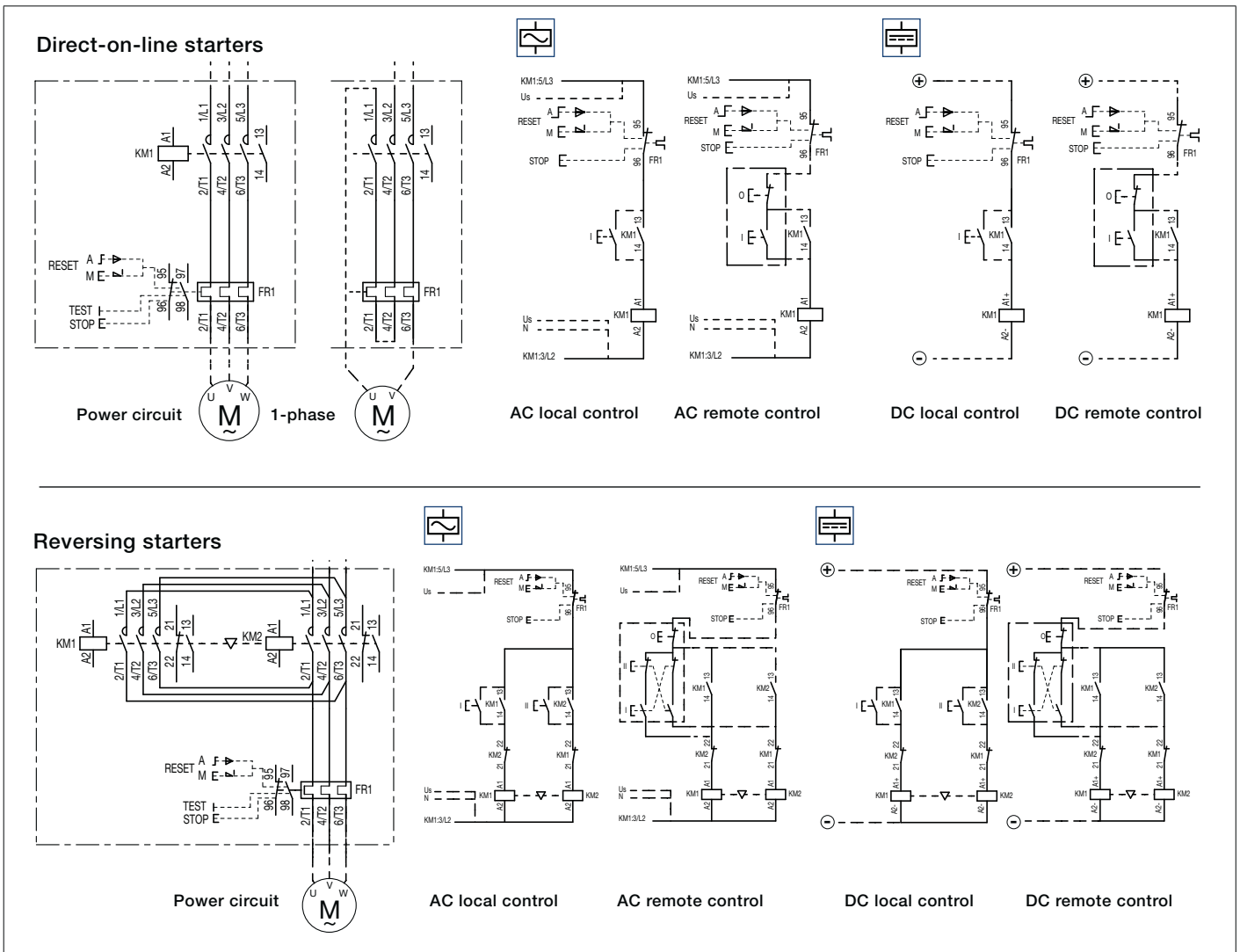

DOL starters protected by thermal overload relays

With AS, ASL contactors - open type version in kit form

Contactors - AC operated

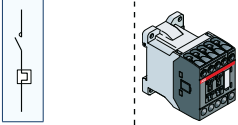
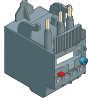
Contactors				Thermal overload relays			Accessories	
								
IEC AC-3, 400 V Rated operational power kW	Rated control circuit voltage Uc (1) A	Type		Order code	Setting ranges A ... A	Type	Order code	
		V 50 Hz	V 60 Hz					
4	8.5	24	24	AS09-30-10-20	7.60...10.0	T16-10	1SAZ711201R1043	-
		230	230	AS09-30-10-26				
5.5	11.5	24	24	AS12-30-10-20	10.0...13.0	T16-13	1SAZ711201R1045	-
		230	230	AS12-30-10-26				
7.5	15.5	24	24	AS16-30-10-20	13.0...16.0	T16-16	1SAZ711201R1047	-
		230	230	AS16-30-10-26				

Contactors - DC operated

IEC AC-3, 400 V Rated operational power kW	Rated control circuit voltage Uc (1) A	DC	Type	Order code	Setting ranges A ... A	Type	Order code	
			4	8.5				
5.5	11.5	24	ASL12-30-10-81	1SBL113001R8110	10.0...13.0	T16-13	1SAZ711201R1045	-
7.5	15.5	24	ASL16-30-10-81	1SBL123001R8110	13.0...16.0	T16-16	1SAZ711201R1047	-

Note: for multiple packaging, please contact your ABB local sales organization.
 (1) Other control voltages see voltage code table.



see table below for all setting ranges

Setting ranges	Type	Order code
A ... A		
0.10...0.13	T16-0.13	1SAZ711201R1005
0.13...0.17	T16-0.17	1SAZ711201R1008
0.17...0.23	T16-0.23	1SAZ711201R1009
0.23...0.31	T16-0.31	1SAZ711201R1013
0.31...0.41	T16-0.41	1SAZ711201R1014
0.41...0.55	T16-0.55	1SAZ711201R1017
0.55...0.74	T16-0.74	1SAZ711201R1021
0.74...1.00	T16-1.0	1SAZ711201R1023
1.00...1.30	T16-1.3	1SAZ711201R1025
1.30...1.70	T16-1.7	1SAZ711201R1028
1.70...2.30	T16-2.3	1SAZ711201R1031
2.30...3.10	T16-3.1	1SAZ711201R1033
3.10...4.20	T16-4.2	1SAZ711201R1035
4.20...5.70	T16-5.7	1SAZ711201R1038
5.70...7.60	T16-7.6	1SAZ711201R1040
7.60...10.0	T16-10	1SAZ711201R1043
10.0...13.0	T16-13	1SAZ711201R1045
13.0...16.0	T16-16	1SAZ711201R1047

Reversing starters protected by thermal overload relays

With AS, ASL contactors - open type version in kit form

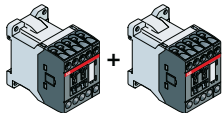
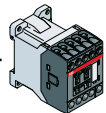
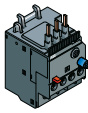
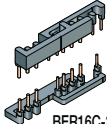
Contactors - AC operated

Contactors				Thermal overload relays			Accessories			
										
IEC AC-3, 400 V Rated operational power kW	Rated control circuit voltage U _c (1) A	V 50 Hz	V 60 Hz	Type	Order code	Setting ranges A ... A	Type	Order code	Type	Order code
4	8.5	24	24	AS09-30-01-20	1SBL101001R2001	7.60...10.0	T16-10	1SAZ711201R1043	BER16C-3 + VM3 + 2x CA3-10	1SBN081012R1000 + 1SBN031005T1000 + 1SBN011010T1010
		230	230	AS09-30-01-26	1SBL101001R2601					
5.5	11.5	24	24	AS12-30-01-20	1SBL111001R2001	10.0...13.0	T16-13	1SAZ711201R1045	BER16C-3 + VM3 + 2x CA3-10	1SBN081012R1000 + 1SBN031005T1000 + 1SBN011010T1010
		230	230	AS12-30-01-26	1SBL111001R2601					
7.5	15.5	24	24	AS16-30-01-20	1SBL121001R2001	13.0...16.0	T16-16	1SAZ711201R1047	BER16C-3 + VM3 + 2x CA3-10	1SBN081012R1000 + 1SBN031005T1000 + 1SBN011010T1010
		230	230	AS16-30-01-26	1SBL121001R2601					

Contactors - DC operated

IEC AC-3, 400 V Rated operational power kW	Rated control circuit voltage U _c (1) A	DC	Type	Order code	Setting ranges A ... A	Type	Order code	Type	Order code
4	8.5	24	ASL09-30-10-81	1SBL103001R8110	7.60...10.0	T16-10	1SAZ711201R1043	BER16C-3 + VM3 + 2x CA3-10	1SBN081012R1000 + 1SBN031005T1000 + 1SBN011010T1010
5.5	11.5	24	ASL12-30-10-81	1SBL113001R8110	10.0...13.0	T16-13	1SAZ711201R1045	BER16C-3 + VM3 + 2x CA3-10	1SBN081012R1000 + 1SBN031005T1000 + 1SBN011010T1010
7.5	15.5	24	ASL16-30-10-81	1SBL123001R8110	13.0...16.0	T16-16	1SAZ711201R1047	BER16C-3 + VM3 + 2x CA3-10	1SBN081012R1000 + 1SBN031005T1000 + 1SBN011010T1010

Note: for multiple packaging, please contact your ABB local sales organization.

(1) Other control voltages see voltage code table.

see table below for all setting ranges

Setting ranges A ... A	Type	Order code
0.10...0.13	T16-0.13	1SAZ711201R1005
0.13...0.17	T16-0.17	1SAZ711201R1008
0.17...0.23	T16-0.23	1SAZ711201R1009
0.23...0.31	T16-0.31	1SAZ711201R1013
0.31...0.41	T16-0.41	1SAZ711201R1014
0.41...0.55	T16-0.55	1SAZ711201R1017
0.55...0.74	T16-0.74	1SAZ711201R1021
0.74...1.00	T16-1.0	1SAZ711201R1023
1.00...1.30	T16-1.3	1SAZ711201R1025
1.30...1.70	T16-1.7	1SAZ711201R1028
1.70...2.30	T16-2.3	1SAZ711201R1031
2.30...3.10	T16-3.1	1SAZ711201R1033
3.10...4.20	T16-4.2	1SAZ711201R1035
4.20...5.70	T16-5.7	1SAZ711201R1038
5.70...7.60	T16-7.6	1SAZ711201R1040
7.60...10.0	T16-10	1SAZ711201R1043
10.0...13.0	T16-13	1SAZ711201R1045
13.0...16.0	T16-16	1SAZ711201R1047

Star-delta starters protected by thermal overload relays

With AS, ASL contactors - open type version in kit form

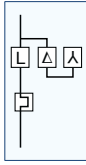

Application

Star-delta starting is the most common method to reduce the starting current of a motor. This system can be used on all the squirrel cage motors, which are normally used in delta connection. In this type of starting, it is recommended to choose motors having high starting torque i.e. much higher than the resistive torque in order to reach sufficient high speed when the motor is connected in star.

When starting:

- Inrush current is reduced to a third of direct starting current
- Motor torque is reduced to a third or even less of direct starting torque.

Transient current is generated when switching from star to delta connection.

During the initial starting phase ("star" connection), the resistive torque of the driven load must remain, irrespective of speed, less than the "star" motor torque until "star-delta" switching occurs.

This starting mode is therefore ideal for machines having low starting torque such as pumps, centrifugal compressors, wood-working machines...

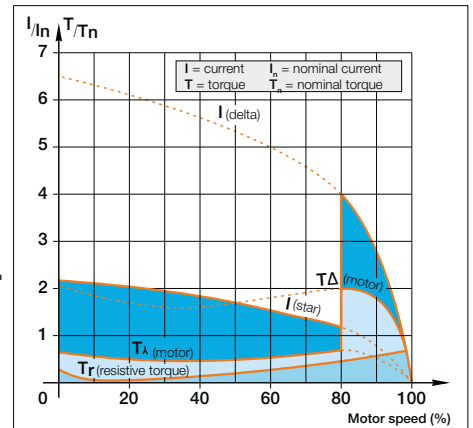

Precaution

- Motor nominal voltage in delta connection must be equal to that of the mains. Example: a motor for 400 V star-delta starting must be designed for 400 V in "delta" connection. Its usual designation is "400 V / 690 V motor". The motor must be constructed with 6 terminal windings
- In order to prevent a high current peak, at least 85 % of nominal speed must be reached before switching from star to delta

Sequence

Starting is a three-stage process:

- 1st stage:** "Star" connection - Press the "On" button on the control circuit to close the KM2 "Star" contactor. The KM1 "line" contactor then closes and the motor starts. Countdown of programmed starting time (6 to 10 s) then begins.
- 2nd stage:** "Star" to "Delta" switching - when programmed starting time is over, the KM2 "Star" contactor opens.
- 3rd stage:** "Delta" connection - A transition time (or dwelling time) of 50 ms is fixed between opening of the "star" contactor and closing of the "delta" contactor by the use of CT-SDS timer. This prevent short-circuit between "star" and "delta".

Main technical data

Standards	IEC 60947-4-1 / EN 60947-4-1
Rated operational voltage U_e max.	690 V - 50/60 Hz
Rated insulation voltage U_i according to IEC 60947-4-1	690 V
Air temperature close to the device	≤ 60 °C
Degree of protection	IP20

Switching frequency
Switching frequency/hour, according to acceleration time and load factor. Respect of the following conditions enables utilization of the starter without excessive overheating of the connections or nuisance tripping of the thermal overload relay.

- Example:
- Switching frequency = 15 starts/hr
 - Motor starting time "Ta" = 7 s (use 8 s curve)
 - Maximum load factor = 63 %
- This corresponds to a 4-minute operating cycle (15 starts/hr) with 7 seconds acceleration, 2.5 minutes operation and 1.5 minutes rest.

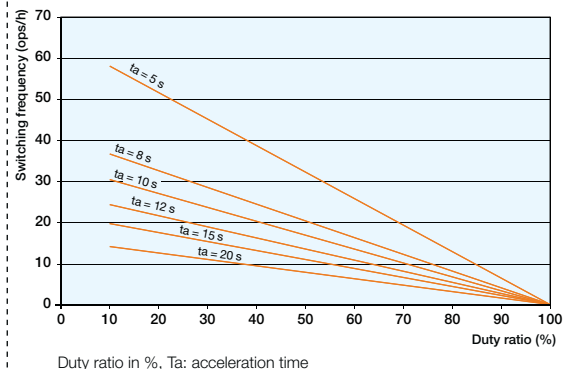

Mounting positions

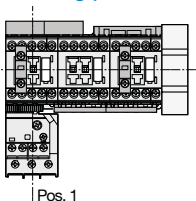

Star-delta starters protected by thermal overload relays

With AS, ASL contactors - open type version in kit form

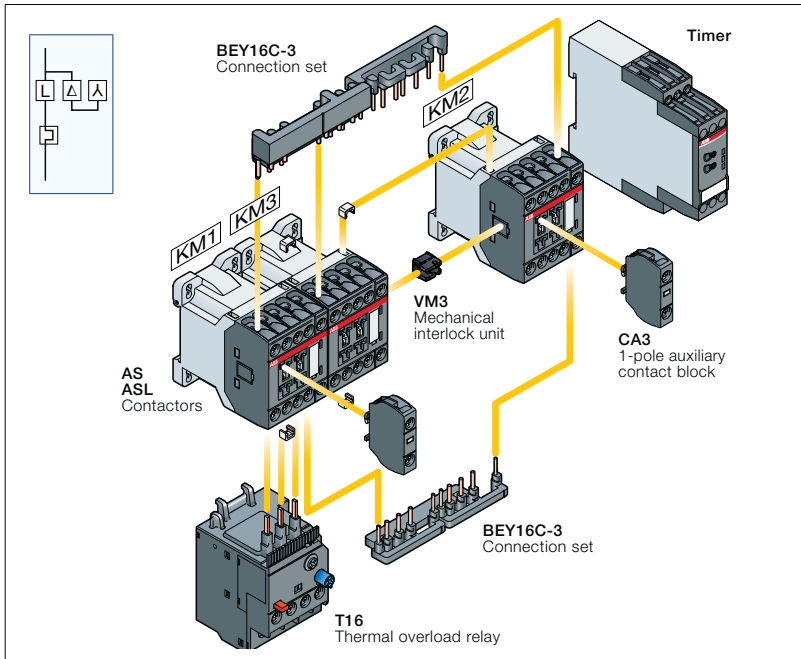

Description

You can easily assemble a star-delta starter thanks to our complete range of accessories:

- VM3 mechanical interlock unit: just clip it between the 2 contactors without increasing starter length.
- BEY16C-3 connection set: it assures a safe and simple connection between contactors main terminals and an electrical interlocking between coil and N.C. built-in auxiliary contact terminals of star and delta contactors.

Select now easily and quickly your starter in the following pages at 400 V, up to 11 kW.

For complete coordination tables, please contact your ABB local sales organization.

Wiring diagrams

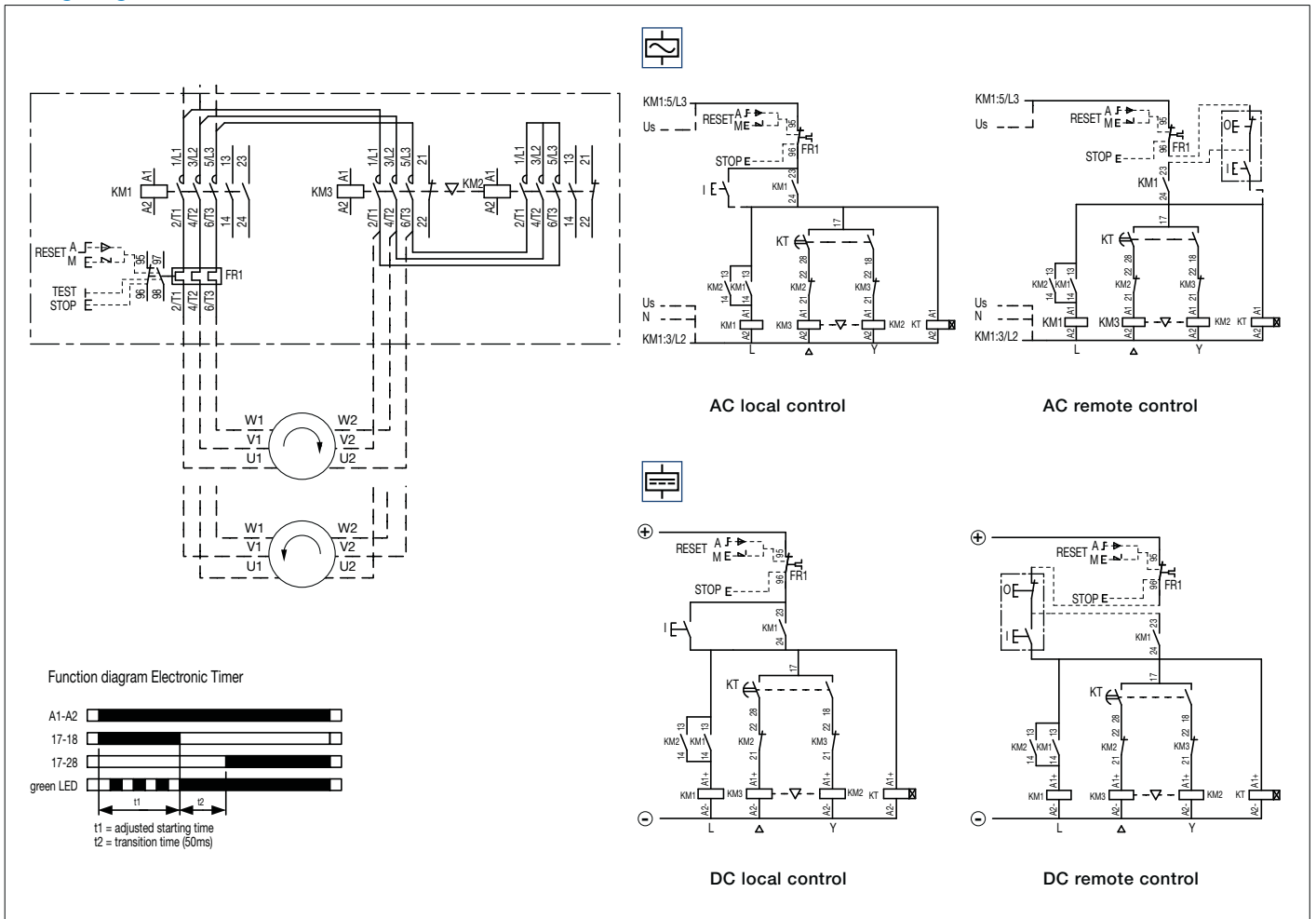

Star-delta starters protected by thermal overload relays

With AS, ASL contactors - open type version in kit form

Contactors - AC operated

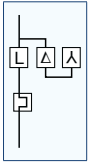

Line contactor KM1

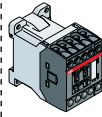

Delta contactor KM3

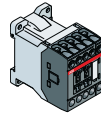

Star contactor KM2

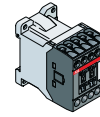

IEC AC-3, 400 V Rated operational power kW	Rated control circuit voltage Uc (1) A	Rated control circuit voltage Uc (1)		Type	Order code	Type	Order code	Type	Order code
		V 50 Hz	V 60 Hz						
7.5	15.5	24	24	AS09-30-10-20	1SBL101001R2010	AS09-30-01-20	1SBL101001R2001	AS09-30-01-20	1SBL101001R2001
		230	230	AS09-30-10-26	1SBL101001R2610	AS09-30-01-26	1SBL101001R2601	AS09-30-01-26	1SBL101001R2601
11	22	24	24	AS12-30-10-20	1SBL111001R2010	AS12-30-01-20	1SBL111001R2001	AS09-30-01-20	1SBL101001R2001
		230	230	AS12-30-10-26	1SBL111001R2610	AS12-30-01-26	1SBL111001R2601	AS09-30-01-26	1SBL101001R2601



Contactors - DC operated

IEC AC-3, 400 V Rated operational power kW	Rated control circuit voltage Uc (1) A	DC	Type	Order code	Type	Order code	Type	Order code
11	22	24	ASL12-30-10-81	1SBL113001R8110	ASL12-30-01-81	1SBL113001R8101	ASL09-30-01-81	1SBL103001R8101

Note: for multiple packaging, please contact your ABB local sales organization.

(1) Other control voltages see voltage code table.

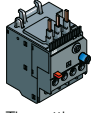
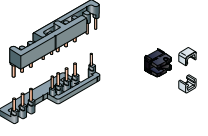
Star-delta starters protected by thermal overload relays With AS, ASL contactors - open type version in kit form

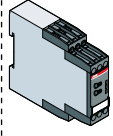
		Thermal overload relays		Connection sets Mechanical interlock unit		Auxiliary contact block		Electronic timer	
		 The setting current value is: nominal motor current x 0.58							
Setting ranges	Type	Order code	Type	Order code	Type	Order code	Type	Order code	
A ... A									
7.60...10.0	T16-10	1SAZ711201R1043	BEY16C-3 + VM3	1SBN081018R2000 + 1SBN031005T1000	KM1: 1 x CA3-10 KM2: 1 x CA3-10	1SBN011010T1010 1SBN011010T1010	CT-SDS...	see "Ordering Details"	
10.0...13.0	T16-13	1SAZ711201R1045	BEY16C-3 + VM3	1SBN081018R2000 + 1SBN031005T1000	KM1: 1 x CA3-10 KM2: 1 x CA3-10	1SBN011010T1010 1SBN011010T1010	CT-SDS...	see "Ordering Details"	

Setting ranges	Type	Order code	Type	Order code	Type	Order code	Type	Order code
A ... A								
7.60...10.0	T16-10	1SAZ711201R1043	BEY16C-3 + VM3	1SBN081018R2000 + 1SBN031005T1000	KM1: 1 x CA3-10 KM2: 1 x CA3-10	1SBN011010T1010 1SBN011010T1010	CT-SDS...	see "Ordering Details"
10.0...13.0	T16-13	1SAZ711201R1045	BEY16C-3 + VM3	1SBN081018R2000 + 1SBN031005T1000	KM1: 1 x CA3-10 KM2: 1 x CA3-10	1SBN011010T1010 1SBN011010T1010	CT-SDS...	see "Ordering Details"

see table below for all setting ranges

Setting ranges A ... A	Type	Order code
0.10...0.13	T16-0.13	1SAZ711201R1005
0.13...0.17	T16-0.17	1SAZ711201R1008
0.17...0.23	T16-0.23	1SAZ711201R1009
0.23...0.31	T16-0.31	1SAZ711201R1013
0.31...0.41	T16-0.41	1SAZ711201R1014
0.41...0.55	T16-0.55	1SAZ711201R1017
0.55...0.74	T16-0.74	1SAZ711201R1021
0.74...1.00	T16-1.0	1SAZ711201R1023
1.00...1.30	T16-1.3	1SAZ711201R1025
1.30...1.70	T16-1.7	1SAZ711201R1028
1.70...2.30	T16-2.3	1SAZ711201R1031
2.30...3.10	T16-3.1	1SAZ711201R1033
3.10...4.20	T16-4.2	1SAZ711201R1035
4.20...5.70	T16-5.7	1SAZ711201R1038
5.70...7.60	T16-7.6	1SAZ711201R1040
7.60...10.0	T16-10	1SAZ711201R1043
10.0...13.0	T16-13	1SAZ711201R1045
13.0...16.0	T16-16	1SAZ711201R1047

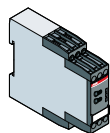

CT-SDS...

Ordering details - Main accessories

	Type	Order code	Pkg qty	Weight (1 pce) kg	
Electronic timer*	28-48 V DC	CT-SDS.22S	1SVR730210R3300	1	0.114
	24-240 V AC				
	380-440 V AC	CT-SDS.23S	1SVR730211R2300	1	0.118

* 7 time ranges (0.05 s - 10 min), 50 ms transition time, 2 n/o contacts, 3 LEDs

Protected by thermal overload relays

With AS, ASL contactors - open type version in kit form

Main dimensions mm, inches

Direct-on-line starters

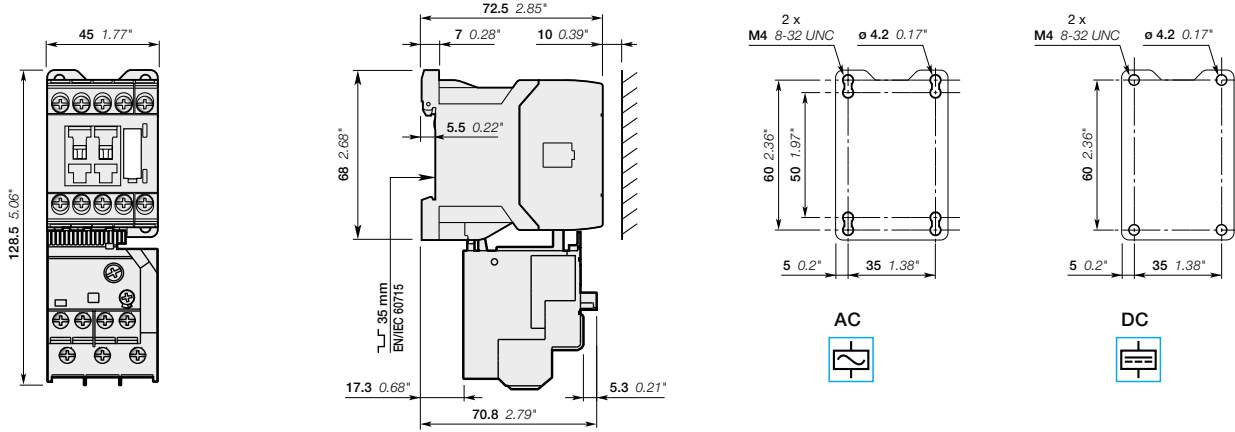

Reversing starters

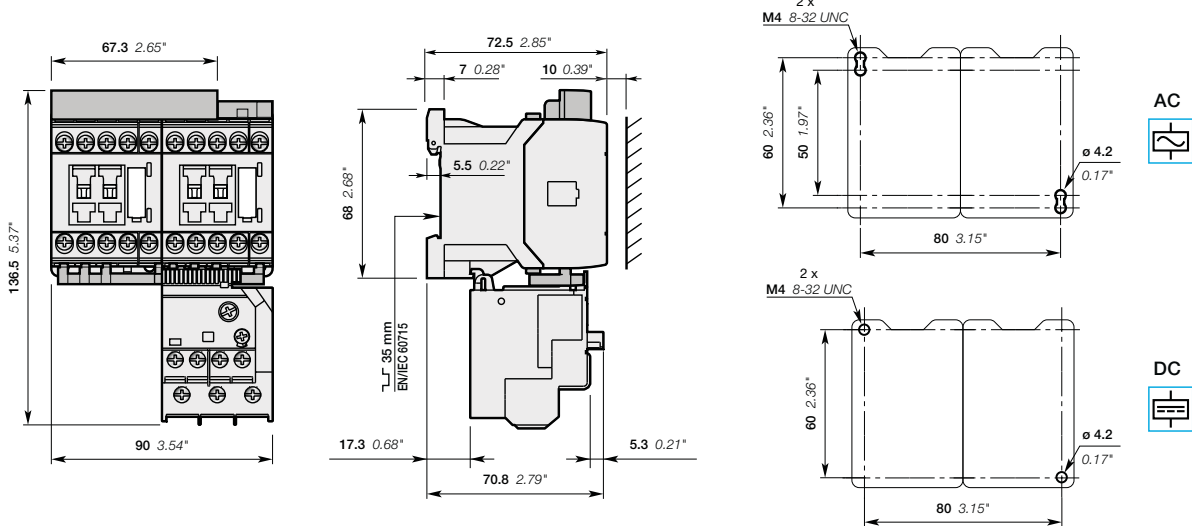

Star-delta starters

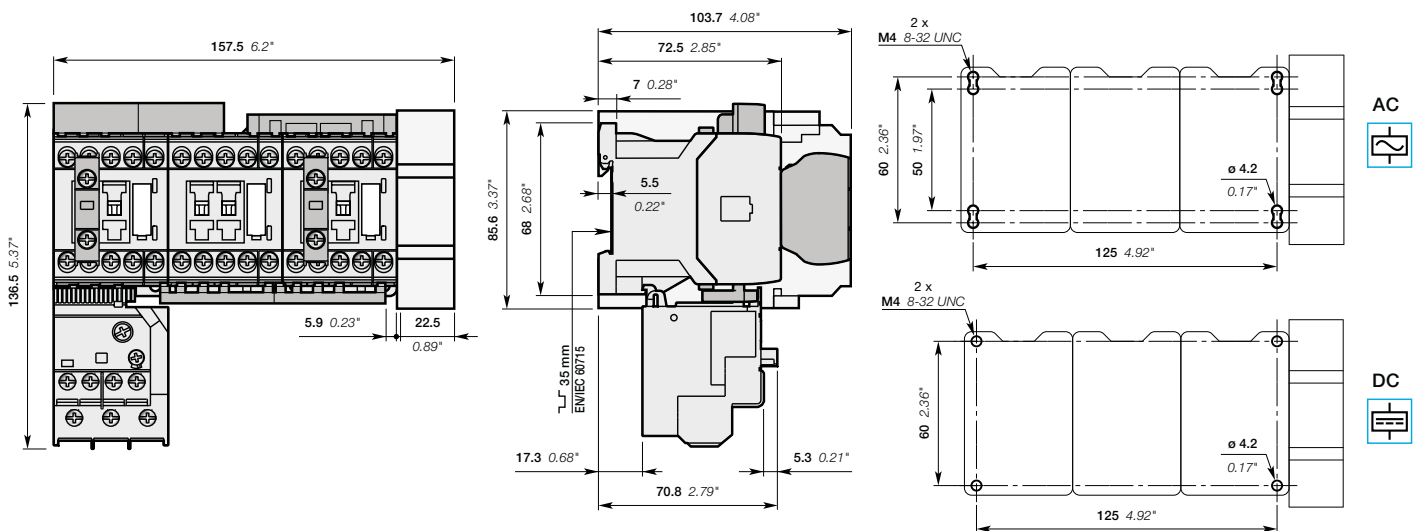

Notes

A series of horizontal dotted lines for taking notes, spanning the width of the page.



3-pole contactors and contactor relays with screw terminals

3-pole contactors

Overview	4/30
AS09 ... AS16 AC operated	4/32
ASL09 ... ASL16 DC operated	4/33
AS09 ... AS16 AC operated - 2-stack	4/34
ASL09 ... ASL16 DC operated - 2-stack	4/35
Main accessories	4/36
Technical data	4/38
Electrical durability	4/44
Terminal marking and positioning	4/52
Dimensions	4/54

3-pole reversing contactors

VAS09 ... VAS16 AC operated	4/46
VASL09 ... VASL16 DC operated	4/47
Technical data	4/48
Terminal marking and positioning	4/52
Dimensions	4/58

Contactor relays

Overview	4/60
NS AC operated	4/62
NSL DC operated	4/63
Main accessories	4/64
Technical data	4/66
Terminal marking and positioning	4/70
Dimensions	4/72

Accessories

Auxiliary contact blocks	4/74
Electronic timers	4/77
Surge suppressors	4/80
Mechanical interlock unit and other accessories	4/82
Connection accessories for starting solutions	4/83

Voltage code table	4/84
--------------------	------

3-pole contactors

Main accessories

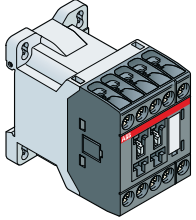

AS09 ... AS16
3-pole contactors

4

Main accessories for contactors

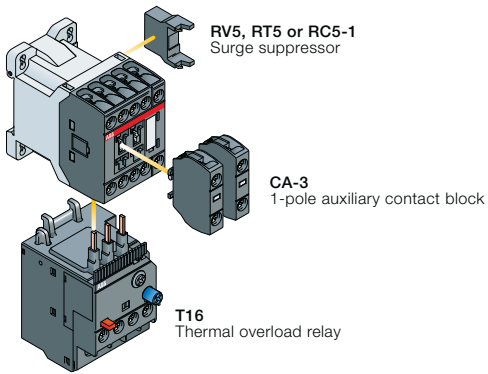

Main accessories for starting solutions

Direct-on-line starter

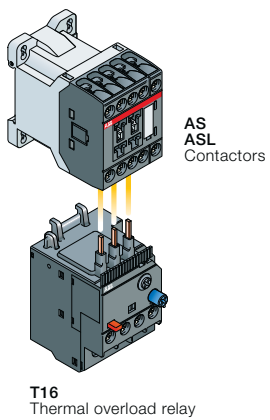

Reversing starter

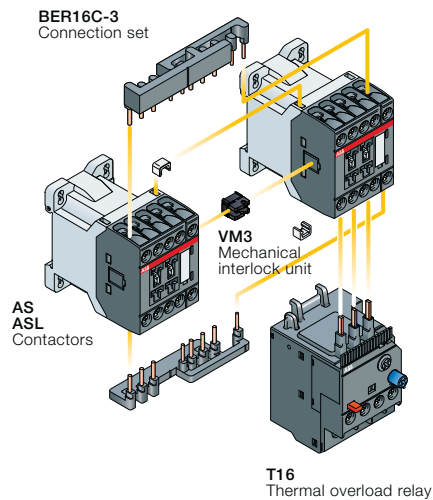

Star-delta starter

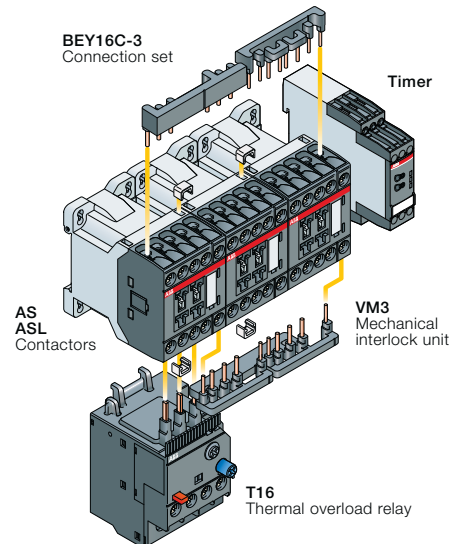

3-pole contactors



Screw terminals



	AC control voltage	AS09	AS12	AS16
	DC control voltage	ASL09	ASL12	ASL16

Switching of 3-phase cage motors

	IEC	AC-3	Rated operational power	400 V	4 kW	5.5 kW	7.5 kW	
			Rated operational current	$\theta \leq 60\text{ }^{\circ}\text{C}$	400 V	9 A	12 A	15.5 A
				$\theta \leq 60\text{ }^{\circ}\text{C}$	415 V	9 A	12 A	15.5 A
			$\theta \leq 60\text{ }^{\circ}\text{C}$	690 V	5 A	7 A	9 A	
UL / CSA	3-phase motor rating		440-480 V	5 hp	7.5 hp	10 hp		
	NEMA size			00	00	0		

Protection of 3-phase motors

Thermal overload relays



T16...

0.10...0.13	0.23...0.31	0.55...0.74	1.30...1.70	3.10...4.20	7.60...10.0
0.13...0.17	0.31...0.41	0.74...1.00	1.70...2.30	4.20...5.70	10.0...13.0
0.17...0.23	0.41...0.55	1.00...1.30	2.30...3.10	5.70...7.60	13.0...16.0

Switching of resistive circuits

	IEC	AC-1	Rated operational current	$\theta \leq 40\text{ }^{\circ}\text{C}$	690 V	22 A	24 A	24 A
				$\theta \leq 60\text{ }^{\circ}\text{C}$	690 V	18 A	20 A	20 A
				$\theta \leq 70\text{ }^{\circ}\text{C}$	690 V	15 A	16 A	16 A
		With conductor cross-sectional area				2.5 mm ²	2.5 mm ²	2.5 mm ²
UL / CSA	General use rating		600 V AC		20 A	20 A	20 A	
	With conductor cross-sectional area				AWG 12	AWG 12	AWG 12	

Main accessories

Auxiliary contact blocks	Front mounting		1-pole CA3-10 or CA3-01
Interlocks	Mechanical		VM3
Surge suppressors	Side-mounted (without additional width)		RV5 (Varistor) AC / DC RC5-1 (Capacitor) AC RT5 (Transil diode) DC
Connection sets	Reversing starters Star-delta starters		BER16C-3 BEY16C-3
Connecting link	With manual motor starter		BEA16-3

AS09 ... AS16 3-pole contactors

4 to 7.5 kW

AC operated



AS09-30-10

4

Description

AS09 ... AS16 contactors are mainly used for controlling 3-phase motors and power circuits up to 690 V AC and 220 V DC.

These contactors are of the block type design with:

- 3 main poles and 1 built-in auxiliary contact
- control circuit: AC operated
- add-on auxiliary contact blocks for front mounting and a comprehensive range of accessories.

Ordering details

IEC Rated operational power 400 V AC-3 kW	Rated operational current $\theta \leq 40\text{ }^\circ\text{C}$ AC-1 A	UL/CSA 3-phase motor rating 480 V hp	General use rating 600 V AC A	Rated control circuit voltage Uc (1)		Auxiliary contacts fitted 	Type	Order code	Weight Pkg (1 pce) kg
				V 50 Hz	V 60 Hz				
4	22	5	20	24	24	1 0	AS09-30-10-20	1SBL101001R2010	0.220
						0 1	AS09-30-01-20	1SBL101001R2001	0.220
				230	230	1 0	AS09-30-10-26	1SBL101001R2610	0.220
						0 1	AS09-30-01-26	1SBL101001R2601	0.220
5.5	24	7.5	20	24	24	1 0	AS12-30-10-20	1SBL111001R2010	0.220
						0 1	AS12-30-01-20	1SBL111001R2001	0.220
				230	230	1 0	AS12-30-10-26	1SBL111001R2610	0.220
						0 1	AS12-30-01-26	1SBL111001R2601	0.220
7.5	24	10	20	24	24	1 0	AS16-30-10-20	1SBL121001R2010	0.220
						0 1	AS16-30-01-20	1SBL121001R2001	0.220
				230	230	1 0	AS16-30-10-26	1SBL121001R2610	0.220
						0 1	AS16-30-01-26	1SBL121001R2601	0.220

Note: for multiple packaging, please contact your ABB local sales organization.

(1) Other control voltages see voltage code table.

Main dimensions mm, inches

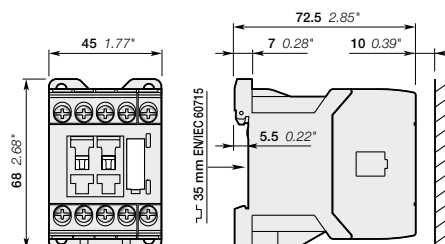

AS09, AS12, AS16

ASL09 ... ASL16 3-pole contactors

4 to 7.5 kW

DC operated



ASL09-30-10

Description

ASL09 ... ASL16 contactors are mainly used for controlling 3-phase motors and power circuits up to 690 V AC and 220 V DC.

These contactors are of the block type design with:

- 3 main poles and 1 built-in auxiliary contact
- control circuit: low consumption (3 W at pull-in and holding) DC operated with solid core magnet. Suitable for direct control by PLC outputs (the polarity on the coil terminals A1+ and A2- must be respected)
- add-on auxiliary contact blocks for front mounting and a comprehensive range of accessories.

Ordering details

IEC		UL/CSA		Rated control circuit voltage Uc (1)	Auxiliary contacts fitted	Type	Order code	Weight Pkg (1 pce) kg
Rated operational power	current $\theta \leq 40\text{ }^\circ\text{C}$	3-phase motor rating 480 V	General use rating 600 V AC					
400 V AC-3 kW	AC-1 A	hp	A	V DC				
4	22	5	20	24	1 0	ASL09-30-10-81	1SBL103001R8110	0.280
					0 1	ASL09-30-01-81	1SBL103001R8101	0.280
5.5	24	7.5	20	24	1 0	ASL12-30-10-81	1SBL113001R8110	0.280
					0 1	ASL12-30-01-81	1SBL113001R8101	0.280
7.5	24	10	20	24	1 0	ASL16-30-10-81	1SBL123001R8110	0.280
					0 1	ASL16-30-01-81	1SBL123001R8101	0.280

Note: for multiple packaging, please contact your ABB local sales organization.

(1) Other control voltages see voltage code table.

Main dimensions mm, inches

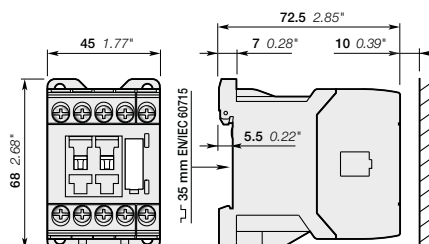

ASL09, ASL12, ASL16

AS09 ... AS16 2-stack 3-pole contactors

4 to 7.5 kW

AC operated



AS09-30-32

1SBC101303R0014

Description

AS09 ... AS16 contactors are mainly used for controlling 3-phase motors and power circuits up to 690 V AC and 220 V DC.

These contactors are of the block type design with:

- 1st stack with 3 main poles and 1 N.O. built-in auxiliary contact
- 2nd stack with permanently fixed 2 N.O. + 2 N.C. auxiliary contact block. The auxiliary contact elements are mechanically linked (side-marked symbol) and the N.C. auxiliary contacts are mirror contacts
- control circuit: AC operated
- a comprehensive range of accessories.

Ordering details

IEC Rated operational power	UL/CSA 3-phase motor rating 480 V	General use rating 600 V AC	Rated control circuit voltage Uc (1)		Auxiliary contacts fitted	Type	Order code	Weight Pkg (1 pce)	
			V 50 Hz	V 60 Hz					
400 V AC-3 kW	AC-1 A	hp	A	24	24	3 2	AS09-30-32-20	1SBL101001R2032	0.260
				230	230				
5.5	24	7.5	20	24	24	3 2	AS12-30-32-20	1SBL111001R2032	0.260
				230	230				
7.5	24	10	20	24	24	3 2	AS16-30-32-20	1SBL121001R2032	0.260
				230	230				

Note: for multiple packaging, please contact your ABB local sales organization.

(1) Other control voltages see voltage code table.

Main dimensions mm, inches

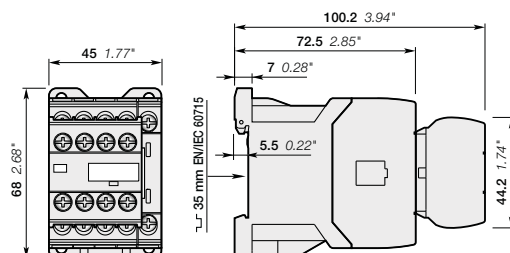

AS09, AS12, AS16

ASL09 ... ASL16 2-stack 3-pole contactors

4 to 7.5 kW

DC operated



ASL09-30-32

Description

ASL09 ... ASL16 contactors are mainly used for controlling 3-phase motors and power circuits up to 690 V AC and 220 V DC.

These contactors are of the block type design with:

- 1st stack with 3 main poles and 1 N.O. built-in auxiliary contact
- 2nd stack with permanently fixed 2 N.O. + 2 N.C. auxiliary contact block. The auxiliary contact elements are mechanically linked (side-marked symbol) and the N.C. auxiliary contacts are mirror contacts
- control circuit: low consumption (3 W at pull-in and holding) DC operated with solid core magnet. Suitable for direct control by PLC outputs (the polarity on the coil terminals A1+ and A2- must be respected)
- a comprehensive range of accessories.

Ordering details

IEC		UL/CSA		Rated control circuit voltage Uc (1)	Auxiliary contacts fitted	Type	Order code	Weight
Rated power	operational current $\theta \leq 40^\circ\text{C}$	3-phase motor rating 480 V	General use rating 600 V AC					
400 V AC-3	AC-1			V DC				kg
kW	A	hp	A					
4	22	5	20	24	3 2	ASL09-30-32-81	1SBL103001R8132	0.320
5.5	24	7.5	20	24	3 2	ASL12-30-32-81	1SBL113001R8132	0.320
7.5	24	10	20	24	3 2	ASL16-30-32-81	1SBL123001R8132	0.320

Note: for multiple packaging, please contact your ABB local sales organization.

(1) Other control voltages see voltage code table.

Main dimensions mm, inches

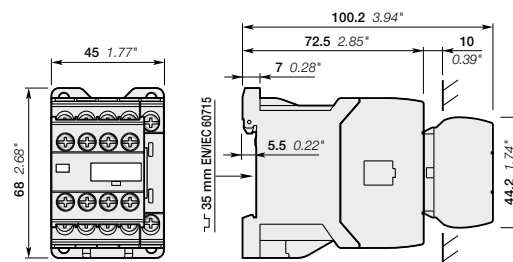

ASL09, ASL12, ASL16

AS09 ... AS16 and ASL09 ... ASL16 3-pole contactors

Main accessories

Contactor and main accessories (other accessories available)

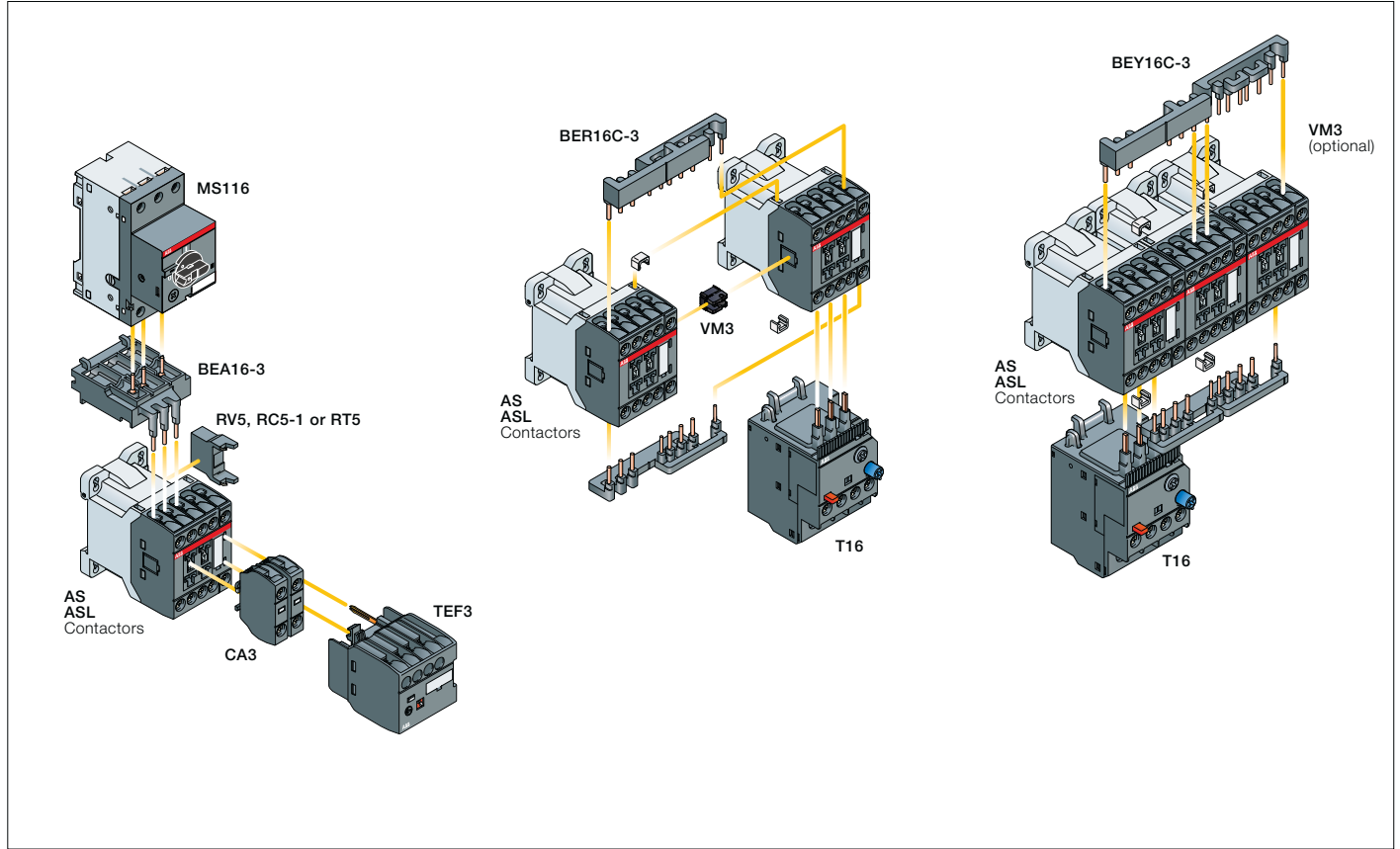

Main accessory fitting details

Many configurations of accessories are possible depending on whether these are front-mounted or side-mounted.

Contactor types	Main poles	Built-in auxiliary contacts	Front-mounted accessories			Side-mounted accessories	
			Auxiliary contact blocks	Electronic timer	Mechanical interlock unit (between 2 contactors)	Surge suppressors	
AS09 ... AS16	3 0	1 0	2 max.	or 1	+ 1	+ RV5	or RC5-1
			–	–	1	+ RV5	or RC5-1
ASL09 ... ASL16	3 0	3 2	2 max.	or 1	+ 1	+ RV5	or RT5
			–	–	1	+ RV5	or RT5

Overload relays fitting details (1)

Contactor types	Thermal overload relays
AS09 ... AS16	T16 (0.10...16 A)
ASL09 ... ASL16	

The addition of an overload relay on the contactor does not prevent fitting of many other accessories as shown above.

(1) Direct mounting - No kit required.

AS09 ... AS16 and ASL09 ... ASL16 3-pole contactors

Main accessories



CA3-10

Front-mounted instantaneous auxiliary contact blocks

For contactors	Auxiliary contacts	Type	Order code	Pkg qty	Weight (1 pce) kg
AS09 ... AS16	1 0	CA3-10	1SBN011010T1010	10	0.011
ASL09 ... ASL16	0 1	CA3-01	1SBN011010T1001	10	0.011



TEF3-ON

Front-mounted electronic timer

For contactors	Rated control circuit voltage - U _c V	Type	Order code	Pkg qty	Weight (1 pce) kg
ON-delay					
AS09 ... AS16, ASL09 ... ASL16	24...240 V AC/DC	TEF3-ON	1SBN021012R1000	1	0.065
OFF-delay					
AS09 ... AS16, ASL09 ... ASL16	24...240 V AC/DC	TEF3-OFF	1SBN021014R1000	1	0.065



VM3

Mechanical interlock unit

For contactors	Type	Order code	Pkg qty	Weight (1 pce) kg
AS09 ... AS16, ASL09 ... ASL16	VM3	1SBN031005T1000	10	0.002



RV5

Surge suppressors

For contactors	Rated control circuit voltage - U _c		Type	Order code	Pkg qty	Weight (1 pce) kg
	V	AC DC				
AS09 ... AS16, ASL09 ... ASL16	24...50	● ●	RV5/50	1SBN050010R1000	2	0.015
	50...133	● ●	RV5/133	1SBN050010R1001	2	0.015
	110...250	● ●	RV5/250	1SBN050010R1002	2	0.015
	250...440	● ●	RV5/440	1SBN050010R1003	2	0.015
AS09 ... AS16	24...50	● -	RC5-1/50	1SBN050100R1000	2	0.012
	50...133	● -	RC5-1/133	1SBN050100R1001	2	0.012
	110...250	● -	RC5-1/250	1SBN050100R1002	2	0.012
	250...440	● -	RC5-1/440	1SBN050100R1003	2	0.012
ASL09 ... ASL16	12...32	- ●	RT5/32	1SBN050020R1000	2	0.015
	25...65	- ●	RT5/65	1SBN050020R1001	2	0.015
	50...90	- ●	RT5/90	1SBN050020R1002	2	0.015
	77...150	- ●	RT5/150	1SBN050020R1003	2	0.015
	150...264	- ●	RT5/264	1SBN050020R1004	2	0.015



BEA16-3

Connecting links with manual motor starters

For contactors	Manual motor starter	Type	Order code	Pkg qty	Weight (1 pce) kg
AS09 ... AS16	MS116-0.16 ... MS116-16	BEA16-3	1SBN081006T1000	10	0.019
ASL09 ... ASL16	MS132-0.16 ... MS132-16				

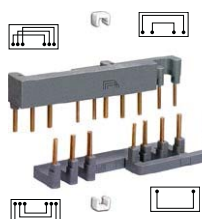

BER16C-3

Connection sets for reversing contactors

For contactors	Mechanical interlock unit	Type	Order code	Pkg qty	Weight (1 pce) kg
AS09 ... AS16, ASL09 ... ASL16	with or without VM3	BER16C-3	1SBN081012R1000	1	0.035

Note: BER16C-3 connection set includes two BB3 fixing clips, and an electrical interlocking when fitted on contactors with built-in N.C. auxiliary contacts. BER16C-3 can be used with or without VM3 mechanical interlock unit.

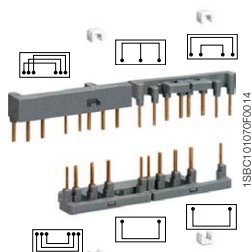

BEY16C-3

Connection sets for star-delta starting

For contactors	Mech. interlock unit between Star & Delta contactors	Type	Order code	Pkg qty	Weight (1 pce) kg
AS09 ... AS12, ASL09 ... ASL12	with or without VM3	BEY16C-3	1SBN081018R2000	1	0.041

Note: BEY16C-3 connection set includes two BB3 fixing clips, and an electrical interlocking when fitted on Star and Delta contactors with built-in N.C. auxiliary contacts. BEY16C-3 can be used with or without VM3 mechanical interlock unit.

AS09 ... AS16 and ASL09 ... ASL16 3-pole contactors

Technical data

Main pole - Utilization characteristics according to IEC

Contactor types	AC operated	AS09	AS12	AS16
	DC operated	ASL09	ASL12	ASL16
Standards		IEC 60947-1 / 60947-4-1 and EN 60947-1 / 60947-4-1		
Rated operational voltage U_e max.		690 V		
Rated frequency (without derating)		50 / 60 Hz		
Conventional free-air thermal current I_{th}				
acc. to IEC 60947-4-1, open contactors, $\theta \leq 40$ °C		22 A	25 A	25 A
With conductor cross-sectional area		2.5 mm ²	4 mm ²	4 mm ²
AC-1 Utilization category				
For air temperature close to contactor				
I_e / Rated operational current AC-1	$\theta \leq 40$ °C	22 A	24 A	24 A
U _e max. \leq 690 V, 50/60 Hz	$\theta \leq 60$ °C	18 A	20 A	20 A
	$\theta \leq 70$ °C	15 A	16 A	16 A
With conductor cross-sectional area		2.5 mm ²		
AC-3 Utilization category				
For air temperature close to contactor $\theta \leq 60$ °C				
I_e / Max. rated operational current AC-3 (1)				
	220-230-240 V	9 A	12 A	15.7 A
	400 V	9 A	12 A	15.5 A
	415 V	9 A	12 A	15.5 A
	440 V	8 A	11 A	13.6 A
	500 V	8 A	11 A	12.5 A
	690 V	5 A	7 A	9 A
Rated operational power AC-3 (1)				
	220-230-240 V	2.2 kW	3 kW	4 kW
	400 V	4 kW	5.5 kW	7.5 kW
	415 V	4 kW	5.5 kW	7.5 kW
	440 V	4 kW	5.5 kW	7.5 kW
	500 V	4 kW	5.5 kW	7.5 kW
	690 V	4 kW	5.5 kW	7.5 kW
Rated making capacity AC-3		10 x I _e AC-3 acc. to IEC 60947-4-1		
Rated breaking capacity AC-3		8 x I _e AC-3 acc. to IEC 60947-4-1		
AC-8a Utilization category				
(without thermal overload relay - U _e 400 V 50/60 Hz - $\theta \leq 40$ °C)				
I_e / Rated operational current AC-8a		12 A	16 A	22 A
Rated operational power AC-8a		5.5 kW	7.5 kW	11 kW
Short-circuit protection device for contactors				
without thermal overload relay - Motor protection excluded (2)				
U _e \leq 500 V AC - gG type fuse		25 A		
Rated short-time withstand current I_{cw}				
at 40 °C ambient temperature,	1 s	230 A	250 A	250 A
in free air from a cold state	10 s	100 A	124 A	124 A
	30 s	65 A	75 A	75 A
	1 min	50 A	55 A	55 A
	15 min	22 A	24 A	24 A
Maximum breaking capacity				
cos ϕ = 0.45	at 440 V	155 A		
	at 690 V	90 A		
Power dissipation per pole				
	I _e / AC-1	1 W	1.2 W	1.2 W
	I _e / AC-3	0.16 W	0.3 W	0.5 W
Max. electrical switching frequency				
	AC-1	600 cycles/h		
	AC-3	1200 cycles/h		
	AC-4	300 cycles/h		

(1) For the corresponding kW/A or hp/A values of 1500 r.p.m, 50 Hz or 1800 r.p.m, 60 Hz, 3-phase motors, see "Motor rated operational powers and currents".

(2) For the protection of motor starters against short circuits, see "Coordination with short-circuit protection devices".

AS09 ... AS16 and ASL09 ... ASL16 3-pole contactors

Technical data

Main pole - Utilization characteristics according to UL / NEMA / CSA

Contactor types	AC operated	AS09	AS12	AS16
	DC operated	ASL09	ASL12	ASL16
Standards	UL 508, CSA C22.2 N°14			
Max. operational voltage	690 V			
NEMA size	00		00	0
NEMA continuous amp rating	Thermal current	9 A	9 A	18 A
NEMA maximum horse power ratings 1-phase, 60 Hz	115 V AC	1/3 hp	1/3 hp	1 hp
	230 V AC	1 hp	1 hp	2 hp
NEMA maximum horse power ratings 3-phase, 60 Hz	200 V AC	1 1/2 hp	1 1/2 hp	3 hp
	230 V AC	1 1/2 hp	1 1/2 hp	3 hp
	460 V AC	2 hp	2 hp	5 hp
	575 V AC	2 hp	2 hp	5 hp
UL / CSA general use rating				
600 V AC	20 A		20 A	20 A
With conductor cross-sectional area	AWG 12		AWG 12	AWG 12
UL / CSA maximum 1-phase motor rating				
Full load current	120 V AC	7.2 A	9.8 A	13.8 A
	240 V AC	8 A	10 A	12 A
Horse power rating	120 V AC	1/3 hp	1/2 hp	3/4 hp
	240 V AC	1 hp	1-1/2 hp	2 hp
UL / CSA maximum 3-phase motor rating				
Full load current (1)	200-208 V AC	7.8 A	7.8 A	11 A
	220-240 V AC	6.8 A	9.6 A	15.2 A
	440-480 V AC	7.6 A	11 A	14 A
	550-600 V AC	9 A	11 A	11 A
Horse power rating (1)	200-208 V AC	2 hp	2 hp	3 hp
	220-240 V AC	2 hp	3 hp	5 hp
	440-480 V AC	5 hp	7-1/2 hp	10 hp
	550-600 V AC	7-1/2 hp	10 hp	10 hp
Short-circuit protection device for contactors				
without thermal overload relay - Motor protection excluded				
Fuse rating	40 A		50 A	60 A
Fuse type, 600 V	J			
Max. electrical switching frequency				
For general use	600 cycles/h			
For motor use	1200 cycles/h			

(1) For the corresponding kW/A or hp/A values of 1500 r.p.m, 50 Hz or 1800 r.p.m, 60 Hz, 3-phase motors, see "Motor rated operational powers and currents".

General technical data

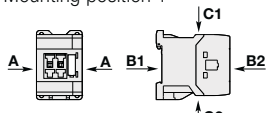
Contactor types	AC operated	AS09	AS12	AS16
	DC operated	ASL09	ASL12	ASL16
Rated insulation voltage Ui				
acc. to IEC 60947-4-1	690 V			
acc. to UL / CSA	600 V			
Rated impulse withstand voltage Uimp.	6 kV			
Ambient air temperature close to contactor				
Operation	Fitted with thermal overload relay	-25...+60 °C		
	Without thermal overload relay	-40...+70 °C		
Storage	-60...+80 °C			
Climatic withstand	Category B according to IEC 60947-1 Annex Q			
Maximum operating altitude (without derating)	3000 m			
Mechanical durability				
Number of operating cycles	10 millions operating cycles			
Max. switching frequency	3600 cycles/h			
Shock withstand	1/2 sinusoidal shock for 11 ms: no change in contact position, closed or open position			
acc. to IEC 60068-2-27 and EN 60068-2-27				
Mounting position 1	Shock direction	AS contactors - AC operated	ASL contactors - DC operated	
	A	20 g	20 g closed position / 10 g open position	
	B1	10 g closed position / 5 g open position	15 g closed position / 5 g open position	
	B2	15 g	10 g	
	C1	20 g closed position / 9 g open position	15 g closed position / 8 g open position	
	C2	20 g closed position / 14 g open position	14 g closed position / 8 g open position	
	Vibration withstand acc. to IEC 60068-2-6	5...300 Hz / 3 g closed position / 2 g open position		

AS09 ... AS16 and ASL09 ... ASL16 3-pole contactors

Technical data

Magnet system characteristics for AS09 ... AS16 contactors

Contactor types	AC operated	AS09	AS12	AS16	
Coil operating limits	AC supply	0.85...1.1 x U _c (at $\theta \leq 60$ °C); U _c (at $\theta \leq 70$ °C)			
AC control voltage	Rated control circuit voltage U _c	at 50 Hz	24...415 V		
		at 60 Hz	24...415 V		
Coil consumption	Average pull-in value	50 Hz	33 VA		
		60 Hz	33 VA		
		50/60 Hz	33 VA		
		Average holding value	50 Hz	6.5 VA / 1.5 W	
			60 Hz	5 VA / 1.2 W	
50/60 Hz	6.5 VA / 1.5 W				
Drop-out voltage		Approx. 30...50 % of U _c			
Operating time					
Between coil energization and:	N.O. contact closing	9...24 ms			
	N.C. contact opening	6...18 ms			
Between coil de-energization and:	N.O. contact opening (1)	5...19 ms			
	N.C. contact closing (1)	7...22 ms			
(1) The use of RC5-1 surge suppressor increases opening time by a factor of 2 to 3					

Magnet system characteristics for ASL09 ... ASL16 contactors

Contactor types	DC operated	ASL09	ASL12	ASL16
Coil operating limits	DC supply	0.85...1.1 x U _c (at $\theta \leq 60$ °C); U _c (at $\theta \leq 70$ °C)		
DC control voltage	Rated control circuit voltage U _c	12...240 V DC		
		Coil consumption	Average pull-in value	3 W
		Average holding value	3 W	
Drop-out voltage		Approx. 10...40 % of U _c		
Coil time constant	Open	L/R	12 ms	
	Closed	L/R	40 ms	
Operating time				
Between coil energization and:	N.O. contact closing	36...59 ms		
	N.C. contact opening	31...53 ms		
Between coil de-energization and:	N.O. contact opening (1)	13...17 ms		
	N.C. contact closing (1)	15...20 ms		
(1) The use of RT5 surge suppressor increases opening time by a factor of 1.1 to 1.2				









Mounting characteristics and conditions for use

Contactor types	AC operated	AS09	AS12	AS16
	DC operated	ASL09	ASL12	ASL16
Mounting positions				
Mounting distances	The contactors can be assembled side by side.			
Fixing	On rail according to IEC 60715, EN 60715	35 x 7.5 mm or 35 x 15 mm		
	By screws (not supplied)	2 x M4 screws placed diagonally		

AS09 ... AS16 and ASL09 ... ASL16 3-pole contactors

Technical data

Connecting characteristics

Contactor types	AC operated	AS09	AS12	AS16
	DC operated	ASL09	ASL12	ASL16
Main terminals	 Screw terminals with cable clamp			
Connection capacity (min. ... max.)				
Main conductors (poles)				
 Rigid solid	1 x	0.75...4 mm ²		
	2 x	0.75...4 mm ²		
 Flexible with non insulated ferrule	1 x	0.75...2.5 mm ²		
	2 x	0.75...2.5 mm ²		
 Flexible with insulated ferrule	1 x	0.75...2.5 mm ²		
	2 x	0.75...1.5 mm ²		
 Bars or lugs	L ≤	7.7 mm		
	l >	3.2 mm		
Connection capacity acc. to UL / CSA	1 or 2 x	AWG 18...12		
Stripping length		9 mm		
Tightening torque	Recommended	1.00 Nm / 9 lb.in		
	Max.	1.20 Nm		
Auxiliary conductors				
(built-in auxiliary terminals + coil terminals)				
 Rigid solid	1 x	0.75...2.5 mm ²		
	2 x	0.75...2.5 mm ²		
 Flexible with non insulated ferrule	1 x	0.75...2.5 mm ²		
	2 x	0.75...2.5 mm ²		
 Flexible with insulated ferrule	1 x	0.75...2.5 mm ²		
	2 x	0.75...1.5 mm ²		
 Lugs	L ≤	7.7 mm		
	l >	3.2 mm		
Connection capacity acc. to UL / CSA	1 or 2 x	AWG 18...14		
Stripping length				
Tightening torque	Coil terminals	Recommended	1.00 Nm / 9 lb.in	
		Max.	1.20 Nm	
Built-in auxiliary terminals		Recommended	1.00 Nm / 9 lb.in	
		Max.	1.20 Nm	
Degree of protection				
acc. to IEC 60947-1 / EN 60947-1 and IEC 60529 / EN 60529				
All terminals		IP20		
Screw terminals				
All terminals		Delivered in open position, screws of unused terminals must be tightened		
		M3		
	Screwdriver type	Flat Ø 5.5 / Pozidriv 2		

AS09 ... AS16 and ASL09 ... ASL16 3-pole contactors

Technical data

Built-in auxiliary contacts according to IEC

Contactor types	AC operated	AS09	AS12	AS16
	DC operated	ASL09	ASL12	ASL16
Rated operational voltage U _e max.		690 V		
Rated frequency (without derating)		50 / 60 Hz		
Conventional free-air thermal current I _{th} - θ ≤ 40 °C		10 A		
I _e / Rated operational current AC-15		10 A		
acc. to IEC 60947-5-1	24-127 V 50/60 Hz	6 A		
	220-240 V 50/60 Hz	4 A		
	400-440 V 50/60 Hz	3 A		
	500 V 50/60 Hz	2 A		
	690 V 50/60 Hz	2 A		
Making capacity AC-15		10 x I _e AC-15 acc. to IEC 60947-5-1		
Breaking capacity AC-15		10 x I _e AC-15 acc. to IEC 60947-5-1		
I _e / Rated operational current DC-13		10 A		
acc. to IEC 60947-5-1	24 V DC	6 A / 144 W		
	48 V DC	2.8 A / 134 W		
	72 V DC	1 A / 72 W		
	110 V DC	0.55 A / 60 W		
	125 V DC	0.55 A / 69 W		
	220 V DC	0.27 A / 60 W		
	250 V DC	0.27 A / 68 W		
Short-circuit protection device gG type fuse		10 A		
Rated short-time withstand current I _{cw}	for 1.0 s	100 A		
	for 0.1 s	140 A		
Minimum switching capacity		12 V / 3 mA		
with failure rate acc. to IEC 60947-5-4		10 ⁻⁷		
Non-overlapping time between N.O. and N.C. contacts		1.5 ms		
Power dissipation per pole at 6 A		0.1 W		
Max. electrical switching frequency	AC-15	1200 cycles/h		
	DC-13	900 cycles/h		
Mechanically linked contacts		Built-in N.O. or N.C. auxiliary contacts and additional N.O. or N.C. auxiliary contacts (CA3 aux. contact blocks) are mechanically linked contacts.		
acc. to annex L of IEC 60947-5-1				
Mirror contacts		Built-in N.C. auxiliary contacts or additional N.C. auxiliary contacts (CA3 aux. contact blocks) are mirror contacts.		
acc. to annex F of IEC 60947-4-1				

Built-in auxiliary contacts according to UL / CSA

Contactor types	AC operated	AS09	AS12	AS16
	DC operated	ASL09	ASL12	ASL16
Max. operational voltage		600 V AC, 250 V DC		
Pilot duty		A600, Q300		
AC thermal rated current		10 A		
AC maximum volt-ampere making		7200 VA		
AC maximum volt-ampere breaking		720 VA		
DC thermal rated current		2.5 A		
DC maximum volt-ampere making-breaking		69 VA		

Notes

A series of horizontal dotted lines for taking notes, spanning the width of the page.

AS09 ... AS16 and ASL09 ... ASL16 3-pole contactors

Electrical durability

Electrical durability for AC-1 utilization category - $U_e \leq 690\text{ V}$

Note: AC-1 maximum current is selected according to ambient temperature. Please see technical data.

Switching non-inductive or slightly inductive loads. The breaking current I_c for AC-1 is equal to the rated operational current of the load. Maximum electrical switching frequency: 600 cycles / hour.

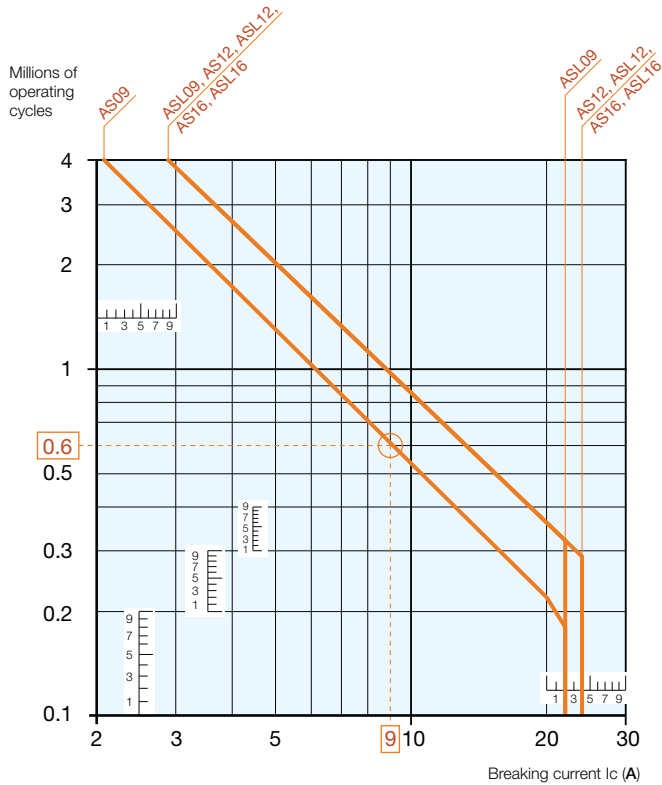

Example:

Breaking current = 9 A.

On the opposite curve at intersection "○" 9 A the corresponding value for the electrical durability is approximately 0.6 millions operating cycles.

AS09 ... AS16 and ASL09 ... ASL16 3-pole contactors

Electrical durability

Electrical durability for AC-3 utilization category - $U_e \leq 440 \text{ V}$ - Ambient temperature $\leq 60 \text{ }^\circ\text{C}$

Switching cage motors: starting and switching off running motors. The breaking current I_c for AC-3 is equal to the rated operational current I_e (I_e = motor full load current). Maximum electrical switching frequency: 1200 cycles / hour.

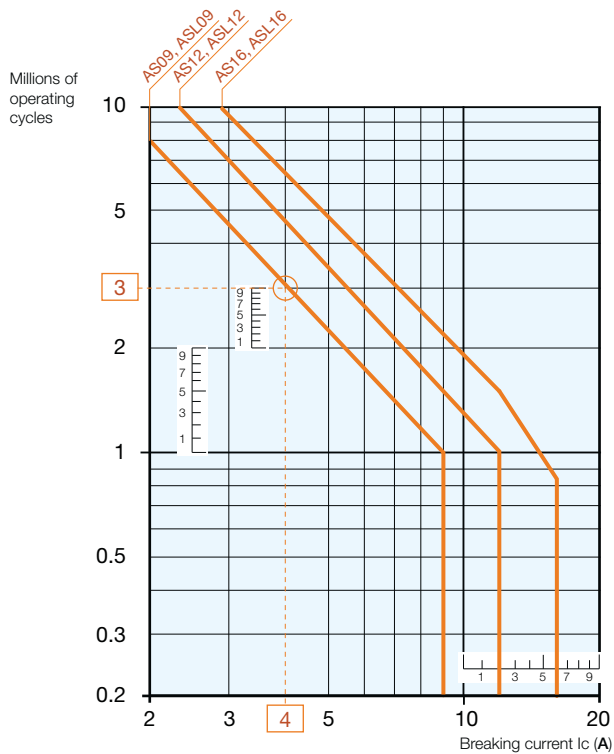

Example:

Breaking current = 4 A.

On the opposite curve at intersection "○" 4 A the corresponding value for the electrical durability is approximately 3 millions operating cycles.

VAS09 ... VAS16 3-pole reversing contactors

4 to 7.5 kW

AC operated



VAS09EM

4

Description

VAS09 ... VAS16 reversing contactors are used for controlling 3-phase motors up to 690 V AC. These reversing contactors include 2 AS09 ... AS16 contactors fitted with 1 N.C. auxiliary contact, 1 VM3 mechanical interlock and BER16C-3 reversing connection set including electrical interlocking. Up to 2 add-on CA3 1-pole auxiliary contact blocks can be mounted per contactor. The reversing contactors are available with or without surge suppressor mounted on each contactor.

Ordering details

IEC	UL/CSA	Rated control circuit voltage U _c		Auxiliary contacts fitted	Type	Order code	Pkg qty	Weight (1 pce)
Rated operational power	3-phase motor rating	(1)						
400 V	480 V	V 50 Hz	V 60 Hz					kg
AC-3	hp							
kW								

Reversing contactors without integrated surge suppressor

Rated operational power (kW)	Motor rating (hp)	U _c 50 Hz (V)	U _c 60 Hz (V)	NO	NC	Type	Order code	Pkg qty	Weight (kg)
4	5	24	24	0	2	VAS09EM-20M	1SBK103600M2000	18	0.480
		230	230	0	2	VAS09EM-26M	1SBK103600M2600	18	0.480
5.5	7.5	24	24	0	2	VAS12EM-20M	1SBK113600M2000	18	0.480
		230	230	0	2	VAS12EM-26M	1SBK113600M2600	18	0.480
7.5	10	24	24	0	2	VAS16EM-20M	1SBK123600M2000	18	0.480
		230	230	0	2	VAS16EM-26M	1SBK123600M2600	18	0.480

Reversing contactors with RC5-1 integrated surge suppressor

Rated operational power (kW)	Motor rating (hp)	U _c 50 Hz (V)	U _c 60 Hz (V)	NO	NC	Type	Order code	Pkg qty	Weight (kg)
4	5	24	24	0	2	VAS09SEM-20M	1SBK103800M2000	18	0.510
		230	230	0	2	VAS09SEM-26M	1SBK103800M2600	18	0.510
5.5	7.5	24	24	0	2	VAS12SEM-20M	1SBK113800M2000	18	0.510
		230	230	0	2	VAS12SEM-26M	1SBK113800M2600	18	0.510
7.5	10	24	24	0	2	VAS16SEM-20M	1SBK123800M2000	18	0.510
		230	230	0	2	VAS16SEM-26M	1SBK123800M2600	18	0.510

(1) Other control voltages see voltage code table.

Note: Minimum switchover delay of 50 ms must be introduced between respective opening and closing of AC operated reversing contactors.

Main dimensions mm, inches

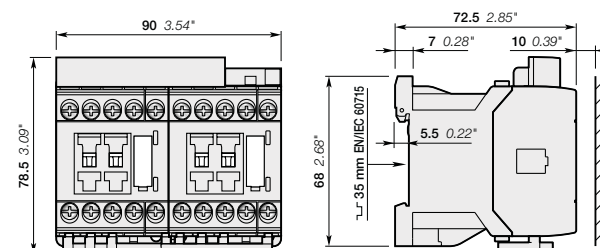

VAS09, VAS12, VAS16

VASL09 ... VASL16 3-pole reversing contactors

4 to 7.5 kW

DC operated



VASL09EM

Description

VASL09 ... VASL16 reversing contactors are used for controlling 3-phase motors up to 690 V AC. These reversing contactors include 2 ASL09 ... ASL16 contactors fitted with 1 N.C. auxiliary contact, 1 VM3 mechanical interlock and BER16C-3 reversing connection set including electrical interlocking.

Up to 2 add-on CA3 1-pole auxiliary contact blocks can be mounted per contactor.

The reversing contactors are available with or without surge suppressor mounted on each contactor.

Ordering details

IEC Rated operational power	UL/CSA 3-phase motor rating 480 V	Rated control circuit voltage Uc (1)	Auxiliary contacts fitted	Type	Order code	Pkg qty	Weight (1 pce)
kW	hp	V DC					kg

Reversing contactors without integrated surge suppressor

4	5	24	0 2	VASL09EM-81M	1SBK103700M8100	18	0.600
5.5	7.5	24	0 2	VASL12EM-81M	1SBK113700M8100	18	0.600
7.5	10	24	0 2	VASL16EM-81M	1SBK123700M8100	18	0.600

Reversing contactors with RV5 integrated surge suppressor

4	5	24	0 2	VASL09SEM-81M	1SBK103900M8100	18	0.630
5.5	7.5	24	0 2	VASL12SEM-81M	1SBK113900M8100	18	0.630
7.5	10	24	0 2	VASL16SEM-81M	1SBK123900M8100	18	0.630

(1) Other control voltages see voltage code table.

Main dimensions mm, inches

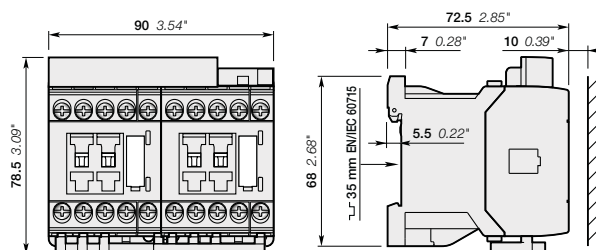

VASL09, VASL12, VASL16

VAS09 ... VAS16 and VASL09 ... VASL16 3-pole reversing contactors

Technical data

Main pole - Utilization characteristics according to IEC

Contractor types	AC operated	VAS09	VAS12	VAS16
	DC operated	VASL09	VASL12	VASL16
Standards	IEC 60947-1 / 60947-4-1 and EN 60947-1 / 60947-4-1			
Rated operational voltage U_e max.	690 V			
Rated frequency (without derating)	50 / 60 Hz			
Conventional free-air thermal current I_{th}				
acc. to IEC 60947-4-1, open contactors, $\theta \leq 40$ °C	22 A	25 A	25 A	
With conductor cross-sectional area	2.5 mm ²	4 mm ²	4 mm ²	
AC-3 Utilization category				
For air temperature close to contactor $\theta \leq 60$ °C				
I_e / Max. rated operational current AC-3 (1)				
	220-230-240 V	9 A	12 A	15.7 A
	400 V	9 A	12 A	15.5 A
	415 V	9 A	12 A	15.5 A
	440 V	8 A	11 A	13.6 A
	500 V	8 A	11 A	12.5 A
	690 V	5 A	7 A	9 A
Rated operational power AC-3 (1)				
	220-230-240 V	2.2 kW	3 kW	4 kW
	400 V	4 kW	5.5 kW	7.5 kW
	415 V	4 kW	5.5 kW	7.5 kW
	440 V	4 kW	5.5 kW	7.5 kW
	500 V	4 kW	5.5 kW	7.5 kW
	690 V	4 kW	5.5 kW	7.5 kW
Rated making capacity AC-3	10 x I _e AC-3 acc. to IEC 60947-4-1			
Rated breaking capacity AC-3	8 x I _e AC-3 acc. to IEC 60947-4-1			
Short-circuit protection device for contactors				
without thermal overload relay - Motor protection excluded (2)				
U _e ≤ 500 V AC - gG type fuse	25 A			
Rated short-time withstand current I_{cw}	1 s	230 A	250 A	250 A
at 40 °C ambient temperature,	10 s	100 A	124 A	124 A
in free air from a cold state	30 s	65 A	75 A	75 A
	1 min	50 A	55 A	55 A
	15 min	22 A	24 A	24 A
Maximum breaking capacity				
cos ϕ = 0.45	at 440 V	155 A		
	at 690 V	90 A		
Power dissipation per pole				
	I_e / AC-3	0.16 W	0.3 W	0.5 W
Max. electrical switching frequency	AC-3	600 cycles/h		

4



3-phase motors

1500 r.p.m. 50 Hz
1800 r.p.m. 60 Hz
3-phase motors

(1) For the corresponding kW/A or hp/A values of 1500 r.p.m, 50 Hz or 1800 r.p.m, 60 Hz, 3-phase motors, see "Motor rated operational powers and currents".

(2) For the protection of motor starters against short circuits, see "Coordination with short-circuit protection devices".

VAS09 ... VAS16 and VASL09 ... VASL16 3-pole reversing contactors

Technical data

Main pole - Utilization characteristics according to UL / NEMA / CSA

Contactor types	AC operated	VAS09	VAS12	VAS16
	DC operated	VASL09	VASL12	VASL16
Standards	UL 508, CSA C22.2 N°14			
Max. operational voltage	690 V			
NEMA size	00		00	0
NEMA continuous amp rating	Thermal current	9 A	9 A	18 A
NEMA maximum horse power ratings 1-phase, 60 Hz	115 V AC	1/3 hp	1/3 hp	1 hp
	230 V AC	1 hp	1 hp	2 hp
NEMA maximum horse power ratings 3-phase, 60 Hz	200 V AC	1 1/2 hp	1 1/2 hp	3 hp
	230 V AC	1 1/2 hp	1 1/2 hp	3 hp
	460 V AC	2 hp	2 hp	5 hp
	575 V AC	2 hp	2 hp	5 hp
UL / CSA maximum 1-phase motor rating	Full load current			
	120 V AC	7.2 A	9.8 A	13.8 A
	240 V AC	8 A	10 A	12 A
	Horse power rating			
	120 V AC	1/3 hp	1/2 hp	3/4 hp
	240 V AC	1 hp	1-1/2 hp	2 hp
UL / CSA maximum 3-phase motor rating	Full load current (1)			
	200-208 V AC	7.8 A	7.8 A	11 A
	220-240 V AC	6.8 A	9.6 A	15.2 A
	440-480 V AC	7.6 A	11 A	14 A
	550-600 V AC	9 A	11 A	11 A
	Horse power rating (1)			
	200-208 V AC	2 hp	2 hp	3 hp
	220-240 V AC	2 hp	3 hp	5 hp
	440-480 V AC	5 hp	7-1/2 hp	10 hp
	550-600 V AC	7-1/2 hp	10 hp	10 hp
Short-circuit protection device for contactors				
without thermal overload relay - Motor protection excluded				
Fuse rating		40 A	50 A	60 A
Fuse type, 600 V		J		
Max. electrical switching frequency				
For motor use		600 cycles/h		

(1) For the corresponding kW/A or hp/A values of 1500 r.p.m, 50 Hz or 1800 r.p.m, 60 Hz, 3-phase motors, see "Motor rated operational powers and currents".

General technical data

Contactor types	AC operated	VAS09	VAS12	VAS16
	DC operated	VASL09	VASL12	VASL16
Rated insulation voltage Ui				
acc. to IEC 60947-4-1		690 V		
acc. to UL / CSA		600 V		
Rated impulse withstand voltage Uimp.				
6 kV				
Ambient air temperature close to contactor				
Operation	Fitted with thermal overload relay	-25...+60 °C		
	Without thermal overload relay	-40...+70 °C		
Storage		-60...+80 °C		
Climatic withstand				
Category B according to IEC 60947-1 Annex Q				
Maximum operating altitude (without derating)				
3000 m				
Mechanical durability				
Number of operating cycles		5 millions operating cycles		
Max. switching frequency		1800 cycles/h		

VAS09 ... VAS16 and VASL09 ... VASL16 3-pole reversing contactors

Technical data

Magnet system characteristics for VAS09 ... VAS16 contactors

Contactor types	AC operated	VAS09	VAS12	VAS16
Coil operating limits	AC supply	0.85...1.1 x U _c (at $\theta \leq 60$ °C); U _c (at $\theta \leq 70$ °C)		
acc. to IEC 60947-4-1	Rated control circuit voltage U _c	at 50 Hz	24...415 V	
		at 60 Hz	24...415 V	
AC control voltage	Coil consumption	Average pull-in value	50 Hz	33 VA
			60 Hz	33 VA
			50/60 Hz	33 VA
		Average holding value	50 Hz	6.5 VA / 1.5 W
			60 Hz	5 VA / 1.2 W
			50/60 Hz	6.5 VA / 1.5 W
Drop-out voltage		Approx. 30...50 % of U _c		
Operating time				
Between coil energization and:	N.O. contact closing	9...24 ms		
	N.C. contact opening	6...18 ms		
Between coil de-energization and:	N.O. contact opening (1)	5...19 ms		
	N.C. contact closing (1)	7...22 ms		
(1) The use of RC5-1 surge suppressor increases opening time by a factor of 2 to 3.				

Magnet system characteristics for VASL09 ... VASL16 contactors

Contactor types	DC operated	VASL09	VASL12	VASL16
Coil operating limits	DC supply	0.85...1.1 x U _c (at $\theta \leq 60$ °C); U _c (at $\theta \leq 70$ °C)		
acc. to IEC 60947-4-1	Rated control circuit voltage U _c	12...240 V DC		
DC control voltage	Coil consumption	Average pull-in value	3 W	
		Average holding value	3 W	
Drop-out voltage		Approx. 10...40 % of U _c		
Coil time constant	Open	L/R	12 ms	
	Closed	L/R	40 ms	
Operating time				
Between coil energization and:	N.O. contact closing	36...59 ms		
	N.C. contact opening	31...53 ms		
Between coil de-energization and:	N.O. contact opening (1)	13...17 ms		
	N.C. contact closing (1)	15...20 ms		
(1) The use of RT5 surge suppressor increases opening time by a factor of 1.1 to 1.2				







Mounting characteristics and conditions for use

Contactor types	AC operated	VAS09	VAS12	VAS16
	DC operated	VASL09	VASL12	VASL16
Mounting positions				
Mounting distances	The reversing contactors can be assembled side by side.			
Fixing	On rail according to IEC 60715, EN 60715	35 x 7.5 mm or 35 x 15 mm		
	By screws (not supplied)	2 x M4 screws placed diagonally		

VAS09 ... VAS16 and VASL09 ... VASL16 3-pole reversing contactors

Technical data

Connecting characteristics

Contactor types	AC operated	VAS09	VAS12	VAS16
	DC operated	VASL09	VASL12	VASL16
Main terminals	 <p>Screw terminals with cable clamp</p>			
Connection capacity (min. ... max.)				
Main conductors (poles)				
	Rigid solid	1 x	0.75...4 mm ²	
	Flexible with non insulated ferrule	1 x	0.75...2.5 mm ²	
	Flexible with insulated ferrule	1 x	0.75...1.5 mm ²	
	Connection capacity acc. to UL / CSA	1 x	AWG 18...12	
	Stripping length		9 mm	
	Tightening torque		Recommended	
			1.00 Nm / 9 lb.in	
			Max.	
			1.20 Nm	
Auxiliary conductors				
(built-in auxiliary terminals + coil terminals)				
	Rigid solid	1 x	0.75...2.5 mm ²	
	Flexible with non insulated ferrule	1 x	0.75...2.5 mm ²	
	Flexible with insulated ferrule	1 x	0.75...1.5 mm ²	
	Connection capacity acc. to UL / CSA	1 x	AWG 18...14	
	Stripping length		9 mm	
	Tightening torque		Recommended	
	Coil terminals		1.00 Nm / 9 lb.in	
			Max.	
			1.20 Nm	
	Built-in auxiliary terminals		Recommended	
			1.00 Nm / 9 lb.in	
			Max.	
			1.20 Nm	
Degree of protection				
acc. to IEC 60947-1 / EN 60947-1 and IEC 60529 / EN 60529				
	All terminals		IP20	
Screw terminals				
	All terminals		Delivered in open position, screws of unused terminals must be tightened	
			M3	
	Screwdriver type		Flat Ø 5.5 / Pozidriv 2	

AS09 ... AS16 3-pole contactors

Terminal marking and positioning

AS contactors - AC operated

Standard devices without addition of auxiliary contacts

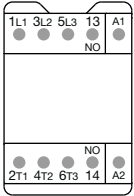

AS09 ... AS16-30-10

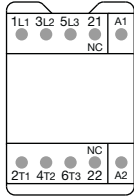

AS09 ... AS16-30-01

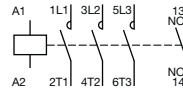

AS09 ... AS16-30-10

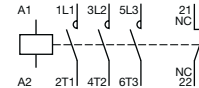

AS09 ... AS16-30-01

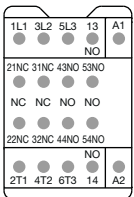

AS09 ... AS16-30-32

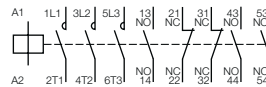

AS09 ... AS16-30-32

4

Other possible contact combinations with auxiliary contact blocks added by the user

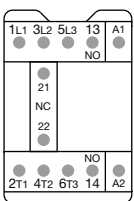

Combination 11

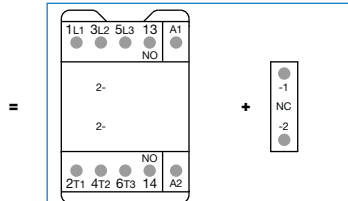

AS09 ... AS16-30-10 + CA3-01

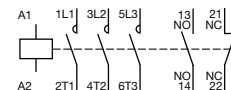

Combination 11

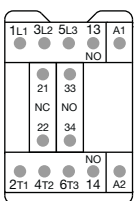

Combination 21

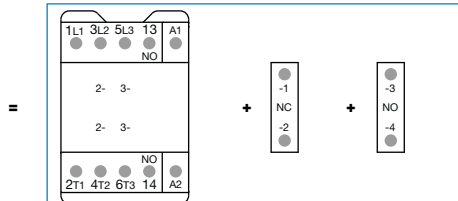

AS09 ... AS16-30-10 + CA3-01 + CA3-10

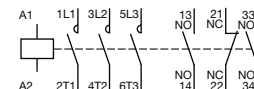

Combination 21

CA3 1-pole auxiliary contact blocks

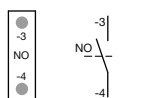

CA3-10



CA3-01

TEF3 front-mounted electronic timer

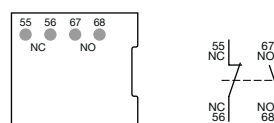

TEF3

ASL09 ... ASL16 3-pole contactors

Terminal marking and positioning

ASL contactors - DC operated (the polarity A1+, A2- must be respected)

Standard devices without addition of auxiliary contacts

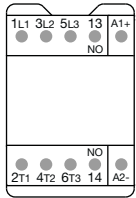

ASL09 ... ASL16-30-10

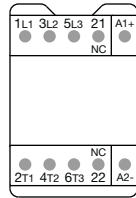

ASL09 ... ASL16-30-01

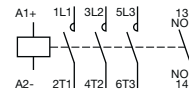

ASL09 ... ASL16-30-10

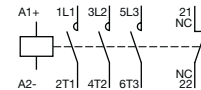

ASL09 ... ASL16-30-01

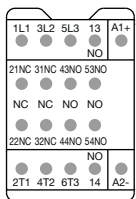

ASL09 ... ASL16-30-32

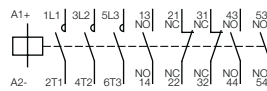

ASL09 ... ASL16-30-32

Other possible contact combinations with auxiliary contact blocks added by the user

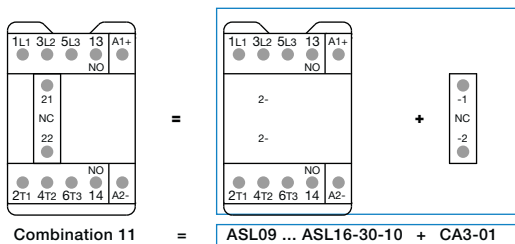

Combination 11

ASL09 ... ASL16-30-10 + CA3-01

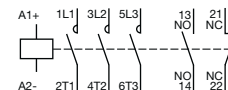

Combination 11

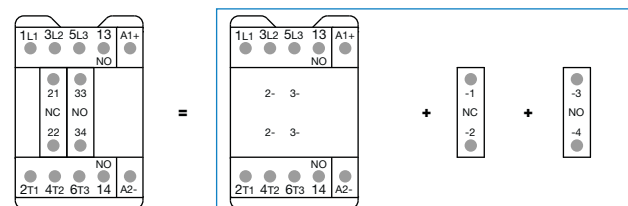

Combination 21

ASL09 ... ASL16-30-10 + CA3-01 + CA3-10

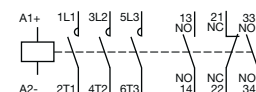

Combination 21

CA3 1-pole auxiliary contact blocks

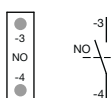

CA3-10

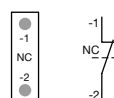

CA3-01

TEF3 front-mounted electronic timer

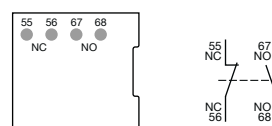

TEF3

AS09 ... AS16 3-pole contactors

Main dimensions mm, inches

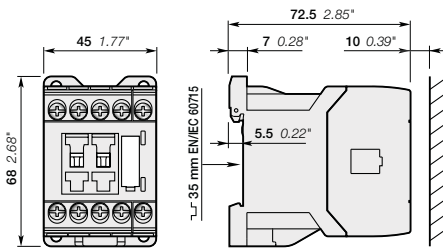

AS09, AS12, AS16

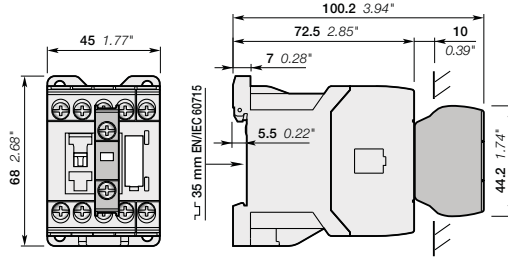

AS09, AS12, AS16
+ CA3 front-mounted 1-pole auxiliary contact block

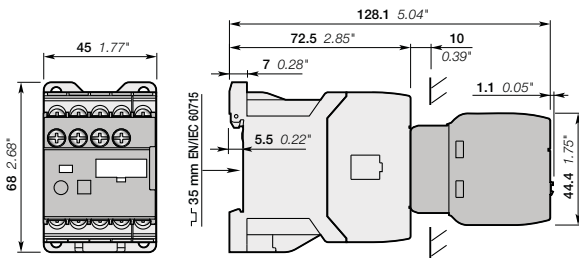
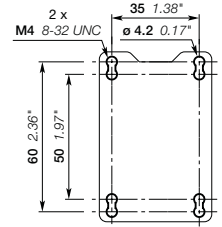

AS09, AS12, AS16
+ TEF3 electronic timer

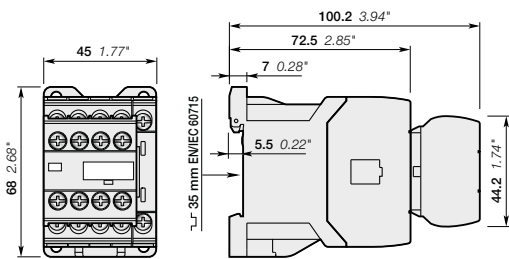

AS09 ... 16-30-32

AS09 ... AS16 3-pole contactors

Main dimensions mm, inches

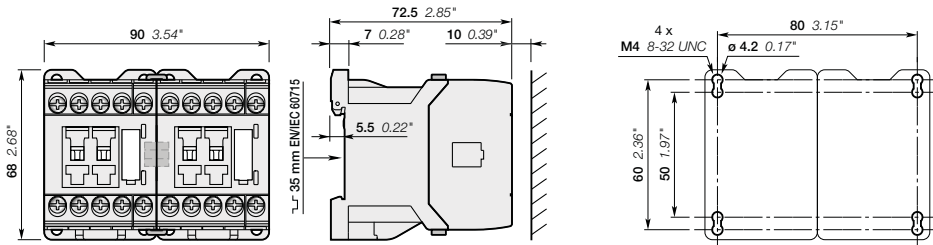

AS09, AS12, AS16
+ VM3 mechanical interlock unit including two BB3 fixing clips

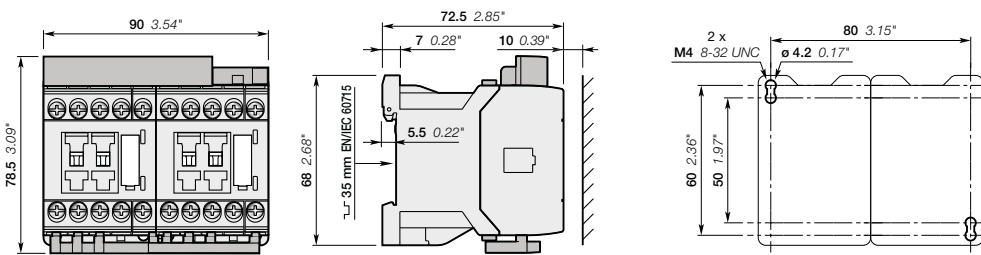

AS09, AS12, AS16
+ BER16C-3 connection set for reversing starter including two BB3 fixing clips

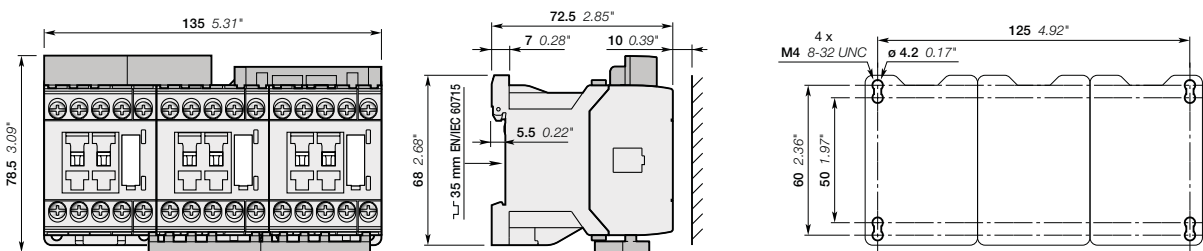

AS09, AS12, AS16
+ BEY16C-3 connection set for star-delta starter including four BB3 fixing clips

ASL09 ... ASL16 3-pole contactors

Main dimensions mm, inches

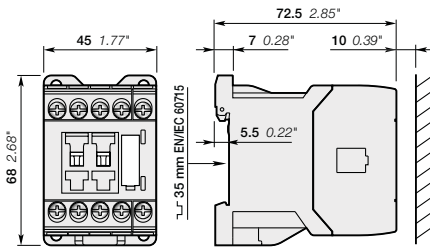

ASL09, ASL12, ASL16

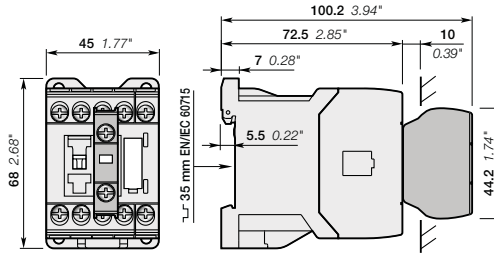

ASL09, ASL12, ASL16
+ CA3 front-mounted 1-pole auxiliary contact block

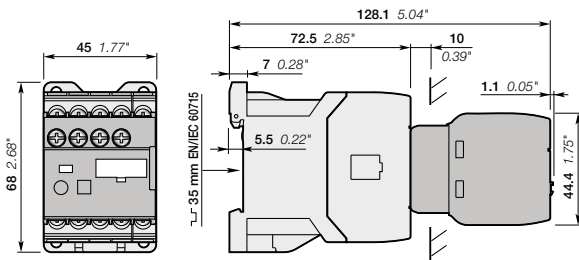
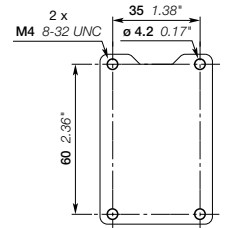

ASL09, ASL12, ASL16
+ TEF3 electronic timer

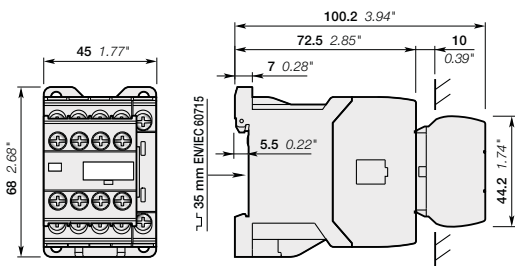

ASL09 ... 16-30-32

ASL09 ... ASL16 3-pole contactors

Main dimensions mm, inches

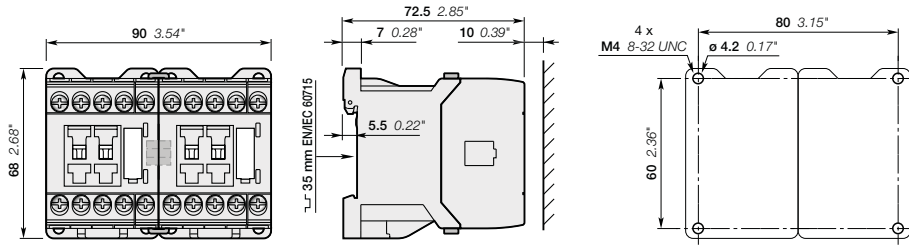

ASL09, ASL12, ASL16
+ VM3 mechanical interlock unit including two BB3 fixing clips

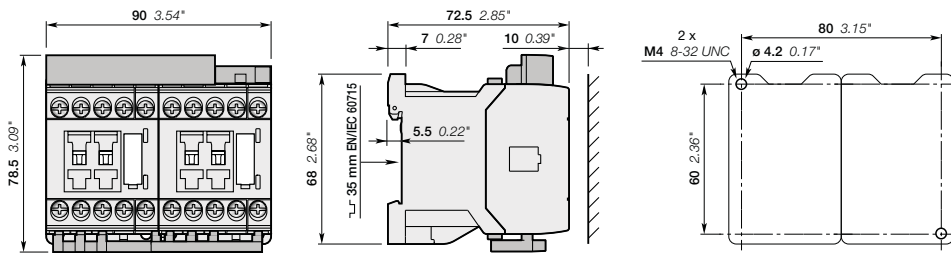

ASL09, ASL12, ASL16
+ BER16C-3 connection set for reversing starter including two BB3 fixing clips

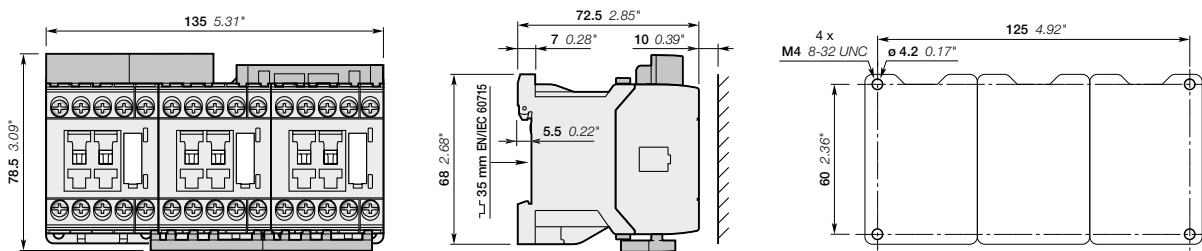

ASL09, ASL12, ASL16
+ BEY16C-3 connection set for star-delta starter including four BB3 fixing clips

VAS09 ... VAS16 reversing contactors

Main dimensions mm, inches

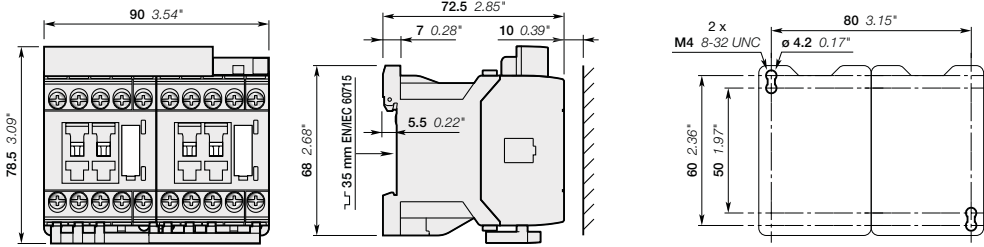

VAS09, VAS12, VAS16

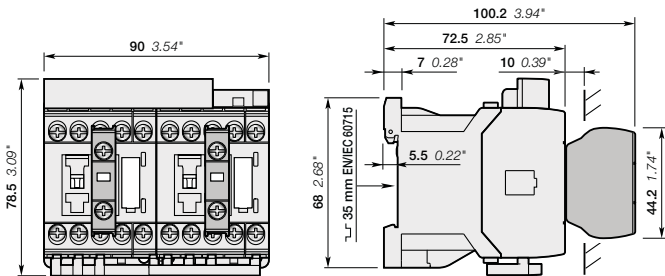

VAS09, VAS12, VAS16
+ CA3 front-mounted 1-pole auxiliary contact block

VASL09 ... VASL16 reversing contactors

Main dimensions mm, inches

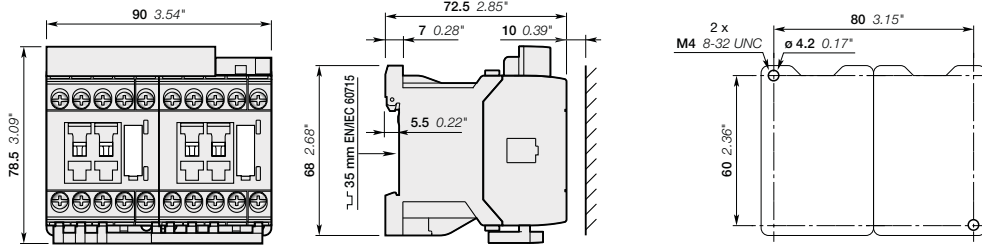

VASL09, VASL12, VASL16

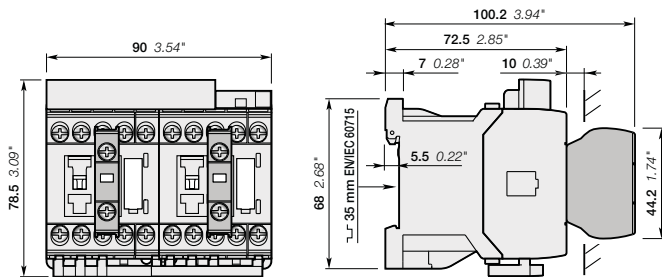

VASL09, VASL12, VASL16
+ CA3 front-mounted 1-pole auxiliary contact block

Contactor relays

Main accessories

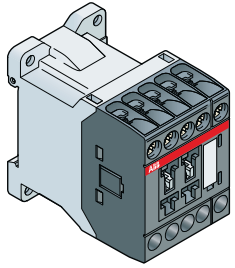

NS, NSL
Contactor relays

4

4-pole contactor relays

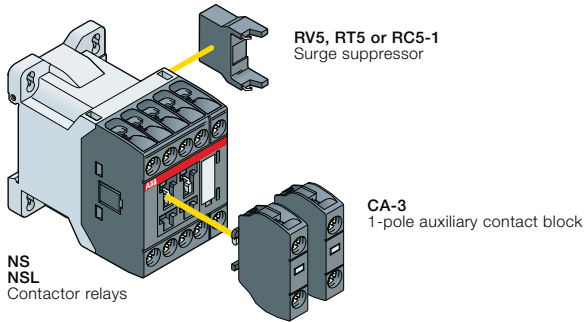

RV5, RT5 or RC5-1
Surge suppressor

CA-3
1-pole auxiliary contact block

**NS
NSL**
Contactor relays

8-pole contactor relays

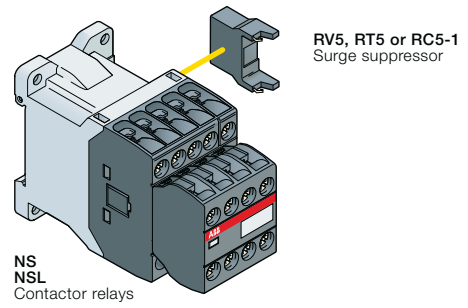

RV5, RT5 or RC5-1
Surge suppressor

**NS
NSL**
Contactor relays

Contactors relays



Screw terminals



NS



NSL

	AC control voltage	NS22E	NS31E	NS40E
	DC control voltage	NSL22E	NSL31E	NSL40E
		2 N.O. + 2 N.C.	3 N.O. + 1 N.C.	4 N.O.

4



NS



NSL

	AC control voltage	NS44E	NS53E	NS62E	NS71E	NS80E
	DC control voltage	NSL44E	NSL53E	NSL62E	NSL71E	NSL80E
		4 N.O. + 4 N.C.	5 N.O. + 3 N.C.	6 N.O. + 2 N.C.	7 N.O. + 1 N.C.	8 N.O.

Control circuit switching

	Rated operational current		
IEC	AC-15	240 V	4 A
		400 V	3 A
		690 V	2 A
DC-13		24 V	6 A / 144 W
		250 V	0.27 A / 68 W
UL / CSA	Pilot Duty	A600, Q300	

Main accessories

Auxiliary contact blocks	Front mounting		1-pole CA3-10 or CA3-01
	Surge suppressors	Side-mounted (without additional width)	 RV5 (Varistor) AC / DC RC5-1 (Capacitor) AC RT5 (Transil diode) DC

1SEC101409S0201

NS contactor relays

AC operated



NS22E

1SBC101012F0014

Description

NS contactor relays are used for switching auxiliary and control circuits.

These contactor relays are designed with:

- 4 poles or 8 poles. Contactor relays have mechanically linked auxiliary contact elements (side-marked symbol)
- control circuit: AC operated
- add-on auxiliary contact blocks for front mounting and a comprehensive range of accessories.

Ordering details

Number of contacts 1st stack	2nd stack	Rated control circuit voltage Uc (1)		Type	Order code	Weight Pkg (1 pce) kg
		V 50 Hz	V 60 Hz			
		24	24	NS22E-20	1SBH101001R2022	0.220
		230	230	NS22E-26	1SBH101001R2622	0.220
		24	24	NS31E-20	1SBH101001R2031	0.220
		230	230	NS31E-26	1SBH101001R2631	0.220
		24	24	NS40E-20	1SBH101001R2040	0.220
		230	230	NS40E-26	1SBH101001R2640	0.220
		24	24	NS44E-20	1SBH101001R2044	0.260
		230	230	NS44E-26	1SBH101001R2644	0.260
		24	24	NS53E-20	1SBH101001R2053	0.260
		230	230	NS53E-26	1SBH101001R2653	0.260
		24	24	NS62E-20	1SBH101001R2062	0.260
		230	230	NS62E-26	1SBH101001R2662	0.260
		24	24	NS71E-20	1SBH101001R2071	0.260
		230	230	NS71E-26	1SBH101001R2671	0.260
		24	24	NS80E-20	1SBH101001R2080	0.260
		230	230	NS80E-26	1SBH101001R2680	0.260

Note: for multiple packaging, please contact your ABB local sales organization.

(1) Other control voltages see voltage code table.

Main dimensions mm, inches

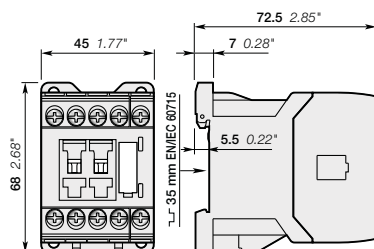

NS22E, NS31E, NS40E

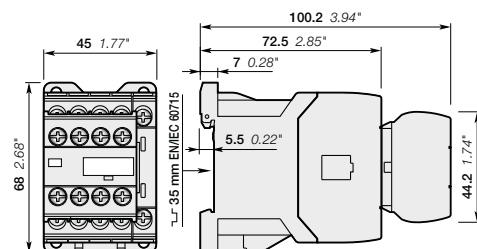

NS44E, NS53E, NS62E, NS71E, NS80E

NSL contactor relays

DC operated



NSL22E

1SBC1018F0014

Description

NSL contactor relays are used for switching auxiliary and control circuits.

These contactor relays are designed with:

- 4 poles or 8 poles. Contactor relays have mechanically linked auxiliary contact elements (side-marked symbol)
- control circuit: low coil consumption (3 W at pull-in and holding) DC operated with solid core magnet. Suitable for direct control by PLC outputs (the polarity on the coil terminals A1+ and A2- must be respected)
- add-on auxiliary contact blocks for front mounting and a comprehensive range of accessories.

Ordering details

Number of contacts		Rated control circuit voltage Uc (1) V DC	Type	Order code	Weight Pkg (1 pce) kg
1st stack	2nd stack				
		24	NSL22E-81	1SBH103001R8122	0.280
		24	NSL31E-81	1SBH103001R8131	0.280
		24	NSL40E-81	1SBH103001R8140	0.280
		24	NSL44E-81	1SBH103001R8144	0.320
		24	NSL53E-81	1SBH103001R8153	0.320
		24	NSL62E-81	1SBH103001R8162	0.320
		24	NSL71E-81	1SBH103001R8171	0.320
		24	NSL80E-81	1SBH103001R8180	0.320

Note: for multiple packaging, please contact your ABB local sales organization.

(1) Other control voltages see voltage code table.

Main dimensions mm, inches

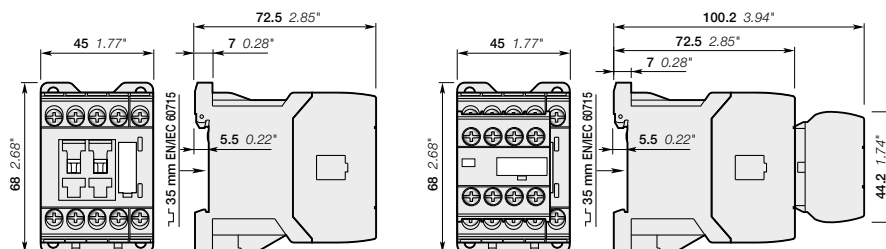

NSL22E, NSL31E, NSL40E

NSL44E, NSL53E, NSL62E, NSL71E, NSL80E

NS and NSL contactor relays

Main accessories

Contactor relays and main accessories (other accessories available)

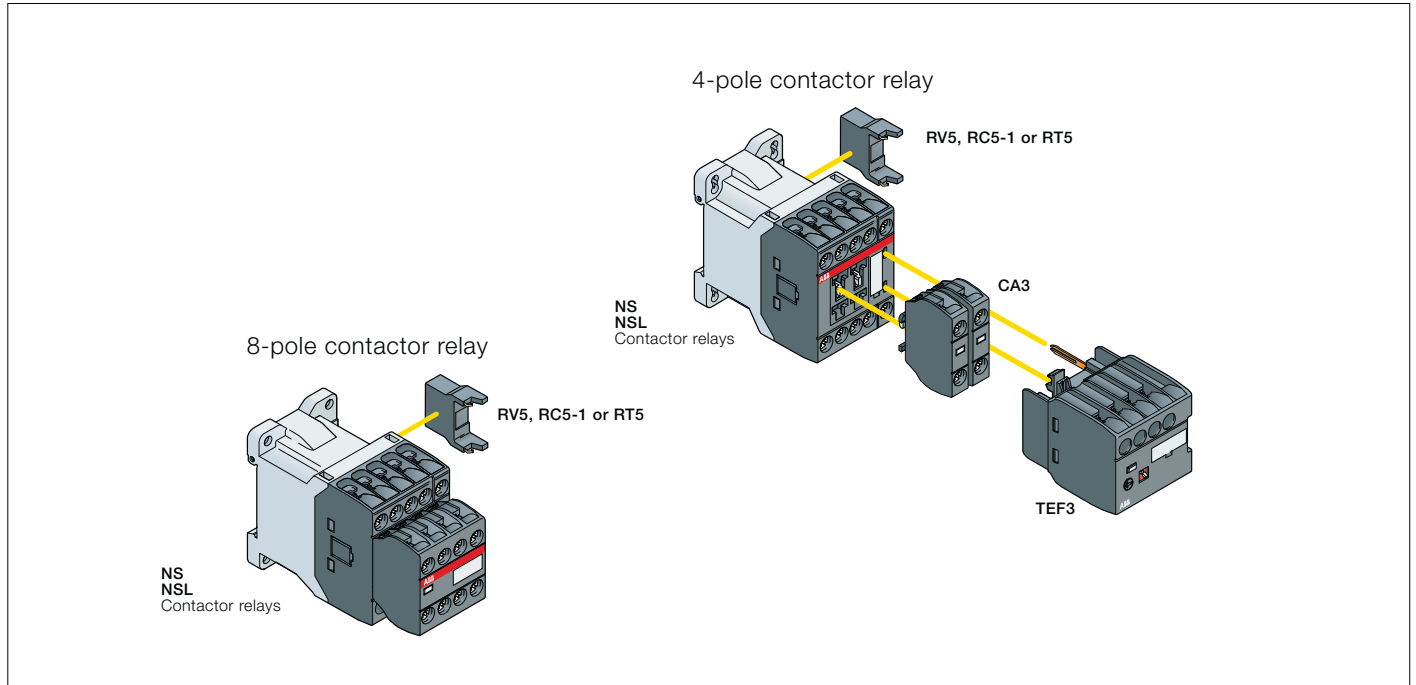

Main accessory fitting details

Contactor types	Main poles	Front-mounted accessories		Side-mounted accessories	
		Auxiliary contact blocks	Electronic timer	Surge suppressors	
		1-pole CA3	TEF3		
NS..	2 2 E	2 max.	or 1	+	RV5 or RC5-1
NS..	3 1 E				
NS..	4 0 E				
NS..	4 4 E	-	-		RV5 or RC5-1
NS..	5 3 E				
NS..	6 2 E				
NS..	7 1 E				
NS..	8 0 E				
NSL..	2 2 E	2 max.	or 1	+	RV5 or RT5
NSL..	3 1 E				
NSL..	4 0 E				
NSL..	4 4 E	-	-		RV5 or RT5
NSL..	5 3 E				
NSL..	6 2 E				
NSL..	7 1 E				
NSL..	8 0 E				

NS and NSL contactor relays

Main accessories



CA3-10





TEF3-ON



RV5

Front-mounted instantaneous auxiliary contact blocks

For contactor relays	Auxiliary contacts	Type	Order code	Pkg qty	Weight (1 pce)
	 				kg
NS, NSL	1 0	CA3-10	1SBN011010T1010	10	0.011
	0 1	CA3-01	1SBN011010T1001	10	0.011

Front-mounted electronic timer

For contactors	Rated control circuit voltage - U _c V	Type	Order code	Pkg qty	Weight (1 pce)
ON-delay					
NS, NSL	24...240 V AC/DC	TEF3-ON	1SBN021012R1000	1	0.065
OFF-delay					
NS, NSL	24...240 V AC/DC	TEF3-OFF	1SBN021014R1000	1	0.065

Surge suppressors

For contactor relays	Rated control circuit voltage - U _c			Type	Order code	Pkg qty	Weight (1 pce)
	V	AC	DC				
NS, NSL	24...50	●	●	RV5/50	1SBN050010R1000	2	0.015
	50...133	●	●	RV5/133	1SBN050010R1001	2	0.015
	110...250	●	●	RV5/250	1SBN050010R1002	2	0.015
	250...440	●	●	RV5/440	1SBN050010R1003	2	0.015
NS	24...50	●	-	RC5-1/50	1SBN050100R1000	2	0.012
	50...133	●	-	RC5-1/133	1SBN050100R1001	2	0.012
	110...250	●	-	RC5-1/250	1SBN050100R1002	2	0.012
	250...440	●	-	RC5-1/440	1SBN050100R1003	2	0.012
NSL	12...32	-	●	RT5/32	1SBN050020R1000	2	0.015
	25...65	-	●	RT5/65	1SBN050020R1001	2	0.015
	50...90	-	●	RT5/90	1SBN050020R1002	2	0.015
	77...150	-	●	RT5/150	1SBN050020R1003	2	0.015
	150...264	-	●	RT5/264	1SBN050020R1004	2	0.015

NS and NSL contactor relays

Technical data

Contact utilization characteristics according to IEC

Contactor relay types	AC operated	NS
	DC operated	NSL
Standards	IEC 60947-5-1 and EN 60947-5-1	
Rated operational voltage U _e max.	690 V	
Rated frequency (without derating)	50 / 60 Hz	
Conventional free-air thermal current I _{th} - θ ≤ 40 °C	10 A	
I _e / Rated operational current AC-15		
acc. to IEC 60947-5-1	24-127 V 50/60 Hz	6 A
	220-240 V 50/60 Hz	4 A
	400-440 V 50/60 Hz	3 A
	500 V 50/60 Hz	2 A
	690 V 50/60 Hz	2 A
Making capacity AC-15	10 x I _e AC-15 acc. to IEC 60947-5-1	
Breaking capacity AC-15	10 x I _e AC-15 acc. to IEC 60947-5-1	
I _e / Rated operational current DC-13		
acc. to IEC 60947-5-1	24 V DC	6 A / 144 W
	48 V DC	2.8 A / 134 W
	72 V DC	1 A / 72 W
	110 V DC	0.55 A / 60 W
	125 V DC	0.55 A / 69 W
	220 V DC	0.27 A / 60 W
	250 V DC	0.27 A / 68 W
Short-circuit protection device for contactors		
U _e ≤ 500 V AC - gG type fuse	10 A	
Rated short-time withstand current I _{cw}	for 1.0 s	100 A
	for 0.1 s	140 A
Minimum switching capacity	12 V / 3 mA	
with failure rate acc. to IEC 60947-5-4	10 ⁻⁷	
Non-overlapping time between N.O. and N.C. contacts	1.5 ms	
Power dissipation per pole at 6 A	0.1 W	
Max. electrical switching frequency	AC-15	1200 cycles/h
	DC-13	900 cycles/h
Mechanically linked contacts	Built-in N.O. or N.C. auxiliary contacts and additional N.O. or N.C. auxiliary contacts (CA3 aux. contact blocks) are mechanically linked contacts.	
acc. to annex L of IEC 60947-5-1		

Contact utilization characteristics according to UL / CSA

Contactor relay types	AC operated	NS
	DC operated	NSL
Standards	UL 508, CSA C22.2 N°14	
Max. operational voltage	600 V AC, 250 V DC	
Pilot duty	A600, Q300	
AC thermal rated current	10 A	
AC maximum volt-ampere making	7200 VA	
AC maximum volt-ampere breaking	720 VA	
DC thermal rated current	2.5 A	
DC maximum volt-ampere making-breaking	69 VA	

NS and NSL contactor relays

Technical data

Magnet system characteristics for NS contactor relays

Contactor relay types	AC operated	NS
Coil operating limits	AC supply	0.85...1.1 x U _c (at $\theta \leq 60$ °C); U _c (at $\theta \leq 70$ °C)
acc. to IEC 60947-5-1		
AC control voltage	Rated control circuit voltage U _c	at 50 Hz : 24...415 V
		at 60 Hz : 24...415 V
Coil consumption	Average pull-in value	50 Hz : 33 VA
		60 Hz : 33 VA
		50/60 Hz : 33 VA
	Average holding value	50 Hz : 6.5 VA / 1.5 W
		60 Hz : 5 VA / 1.2 W
	50/60 Hz : 6.5 VA / 1.5 W	
Drop-out voltage		Approx. 30...50 % of U _c
Operating time		
Between coil energization and:	N.O. contact closing	9...24 ms
	N.C. contact opening	6...18 ms
Between coil de-energization and:	N.O. contact opening (1)	5...19 ms
	N.C. contact closing (1)	7...22 ms
		(1) The use of RC5-1 surge suppressor increases opening time by a factor of 2 to 3.

Magnet system characteristics for NSL contactor relays

Contactor relay types	DC operated	NSL
Coil operating limits	DC supply	0.85...1.1 x U _c (at $\theta \leq 60$ °C); U _c (at $\theta \leq 70$ °C)
acc. to IEC 60947-5-1		
DC control voltage	Rated control circuit voltage U _c	12...240 V DC
	Coil consumption	Average pull-in value : 3 W
		Average holding value : 3 W
Drop-out voltage		Approx. 10...40 % of U _c
Coil time constant	Open	L/R : 12 ms
	Closed	L/R : 40 ms
Operating time		
Between coil energization and:	N.O. contact closing	36...59 ms
	N.C. contact opening	31...53 ms
Between coil de-energization and:	N.O. contact opening (1)	13...17 ms
	N.C. contact closing (1)	15...20 ms
		(1) The use of RT5 surge suppressor increases opening time by a factor of 1.1 to 1.2.

Mounting characteristics and conditions for use

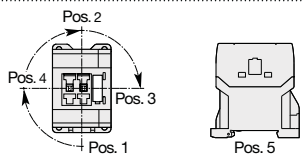
Contactor relay types	AC operated	NS
	DC operated	NSL
Mounting positions		
Mounting distances	The contactor relays can be assembled side by side.	
Fixing	On rail according to IEC 60715, EN 60715	35 x 7.5 mm or 35 x 15 mm
	By screws (not supplied)	2 x M4 screws placed diagonally



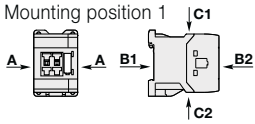

NS and NSL contactor relays

Technical data

General technical data

Contactor relay types	AC operated	NS
	DC operated	NSL
Rated insulation voltage U_i		690 V
acc. to IEC 60947-5-1		600 V
acc. to UL / CSA		6 kV
Rated impulse withstand voltage U_{imp}		
Ambient air temperature close to contactor relay		
Operation in free air		-40...+70 °C
Storage		-60...+80 °C
Climatic withstand		Category B according to IEC 60947-1 Annex Q
Maximum operating altitude (without derating)		3000 m
Mechanical durability		
Number of operating cycles		20 millions operating cycles
Max. switching frequency		3600 cycles/h
Shock withstand		1/2 sinusoidal shock for 11 ms: no change in contact position, closed or open position
acc. to IEC 60068-2-27 and EN 60068-2-27		
Mounting position 1	Shock direction	NS contactor relays - AC operated
	A	20 g
	B1	5 g
	B2	15 g
	C1	19 g closed position / 8 g open position
	C2	16 g closed position / 13 g open position
		NSL contactor relays - DC operated
		20 g closed position / 10 g open position
		15 g closed position / 5 g open position
		10 g
		19 g closed position / 8 g open position
		14 g closed position / 8 g open position
Vibration withstand acc. to IEC 60068-2-6		5...300 Hz / 3 g closed position / 2 g open position

Connecting characteristics

Contactor relay types	AC operated	NS
	DC operated	NSL
Main terminals		
	Screw terminals with cable clamp	
Connection capacity (min. ... max.)		
Pole and coil terminals		
 Rigid solid	1 x	0.75...2.5 mm ²
	2 x	0.75...2.5 mm ²
 Flexible with non insulated ferrule	1 x	0.75...2.5 mm ²
	2 x	0.75...2.5 mm ²
 Flexible with insulated ferrule	1 x	0.75...2.5 mm ²
	2 x	0.75...1.5 mm ²
 Lugs	L ≤	7.7 mm
	L >	3.2 mm
Connection capacity acc. to UL / CSA	1 or 2 x	AWG 18...14
Stripping length		9 mm
Tightening torque	Recommended	1.00 Nm / 9 lb.in
	Max.	1.20 Nm
Degree of protection		
acc. to IEC 60947-1 / EN 60947-1 and IEC 60529 / EN 60529		
All terminals	IP20	
Screw terminals	Delivered in open position, screws of unused terminals must be tightened	
All terminals	M3	
	Screwdriver type	Flat Ø 5.5 / Pozidriv 2

Notes

A series of horizontal dotted lines for taking notes, spanning most of the page width.

NS contactor relays

Terminal marking and positioning

NS contactor relays - AC operated

Standard devices without addition of auxiliary contact blocks

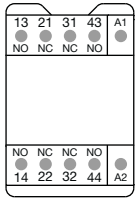

NS22E

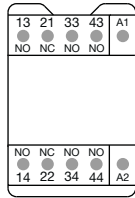

NS31E

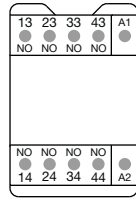

NS40E

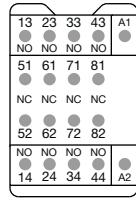

NS44E

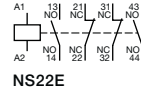

NS22E

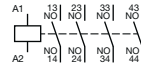

NS40E

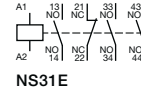

NS31E

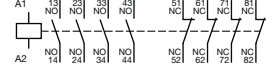

NS44E

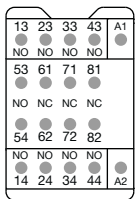

NS53E

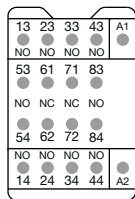

NS62E

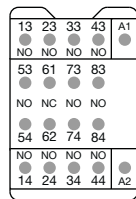

NS71E

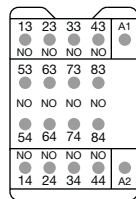

NS80E



NS53E



NS71E

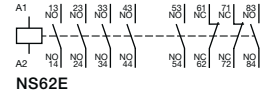

NS62E



NS80E

Other possible contact combinations with auxiliary contact blocks added by the user

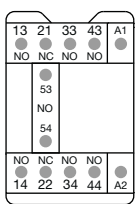

Combination 41E

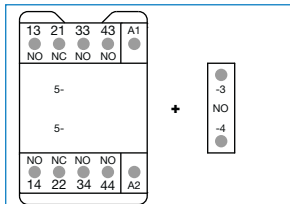

Combination 41E = NS31E + CA3-10

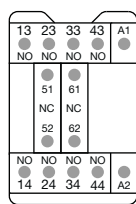

Combination 42E

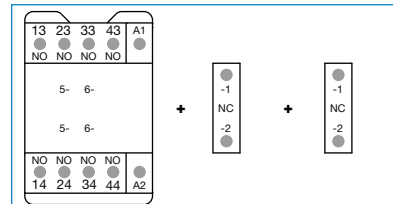

Combination 42E = NS40E + CA3-01 + CA3-01

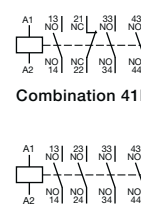

Combination 41E

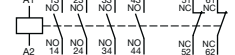

Combination 42E

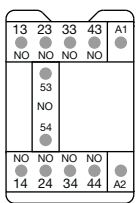

Combination 50E

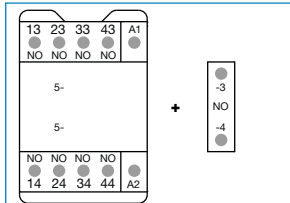

Combination 50E = NS40E + CA3-10

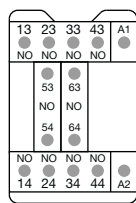

Combination 60E

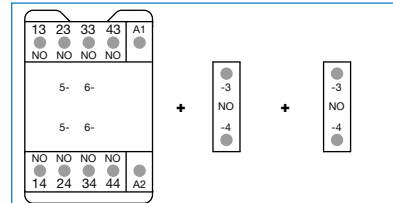

Combination 60E = NS40E + CA3-10 + CA3-10

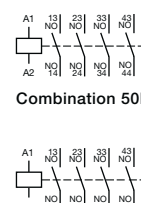

Combination 50E



Combination 60E

CA3 1-pole auxiliary contact blocks

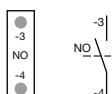

CA3-10

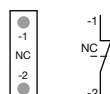

CA3-01

TEF3 front-mounted electronic timer

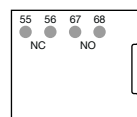

TEF3



NSL contactor relays

Terminal marking and positioning

NSL contactor relays - DC operated (the polarity A1+, A2- must be respected)

Standard devices without addition of auxiliary contact blocks

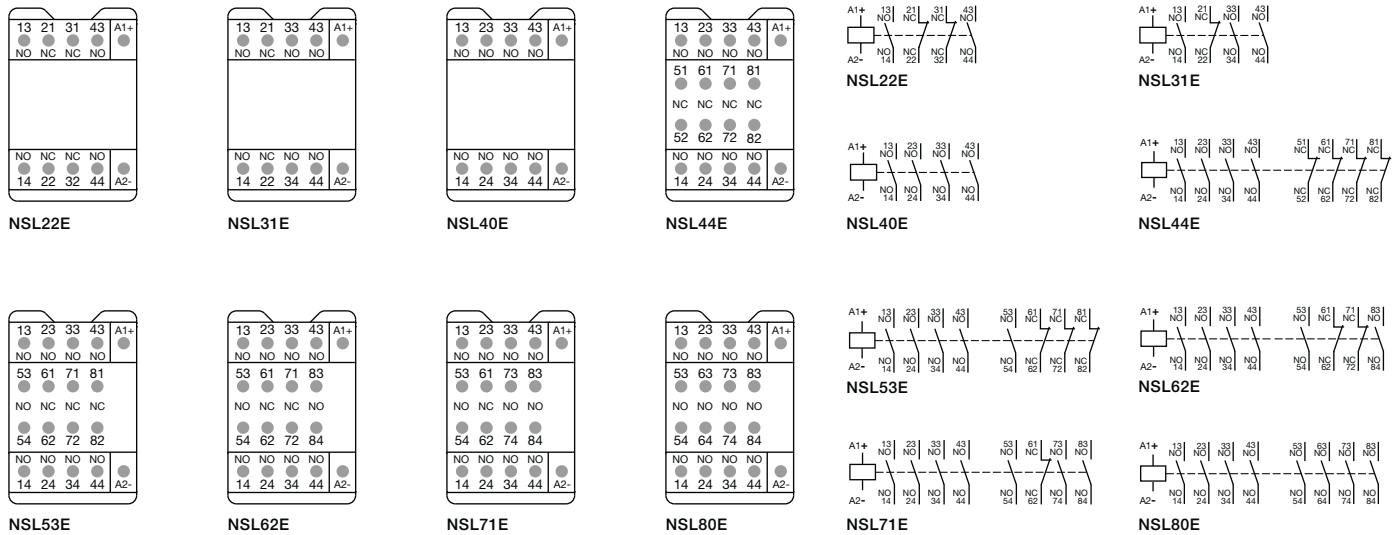

Other possible contact combinations with auxiliary contact blocks added by the user

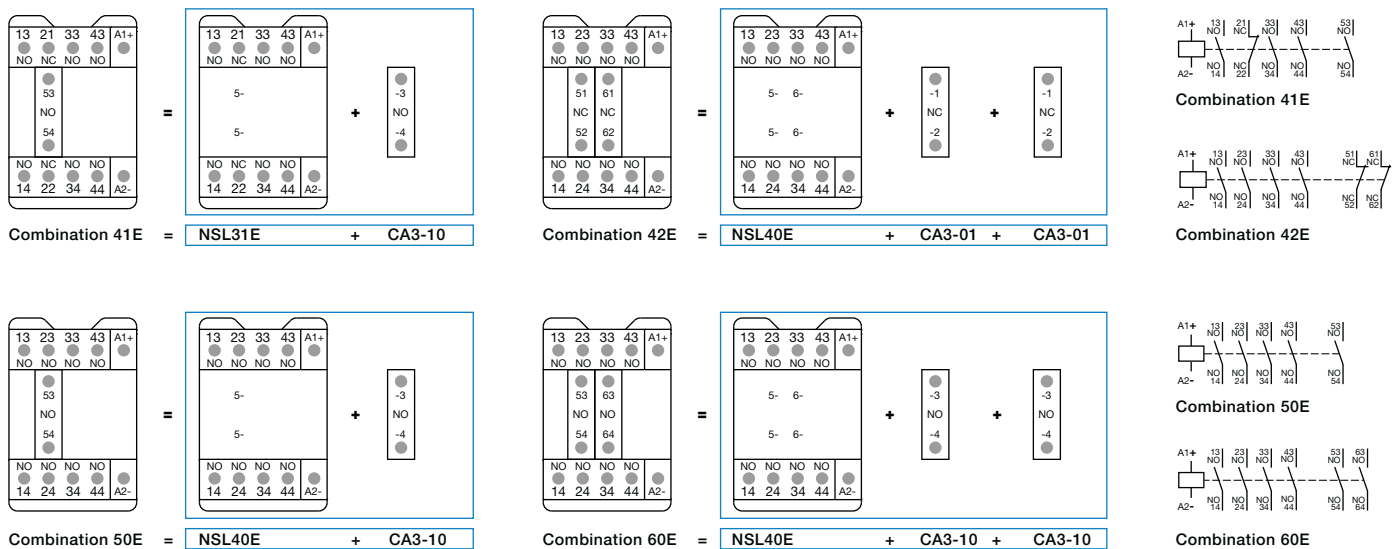

CA3 1-pole auxiliary contact blocks



TEF3 front-mounted electronic timer

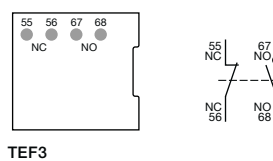

NS contactor relays

Main dimensions mm, inches

4-pole contactor relays

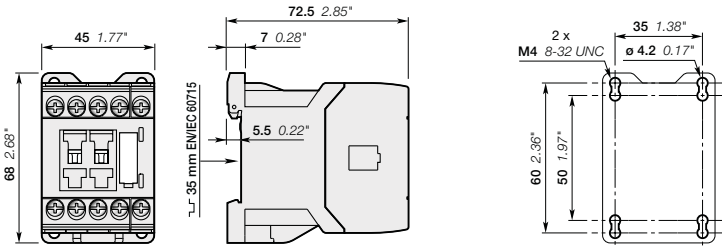

NS22E, NS31E, NS40E

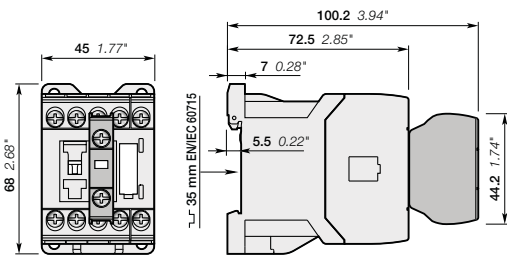

NS22E, NS31E, NS40E

+ CA3 front-mounted 1-pole auxiliary contact block

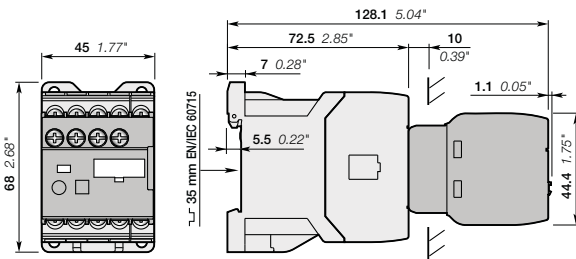

NS22E, NS31E, NS40E

+ TEF3 electronic timer

8-pole contactor relays

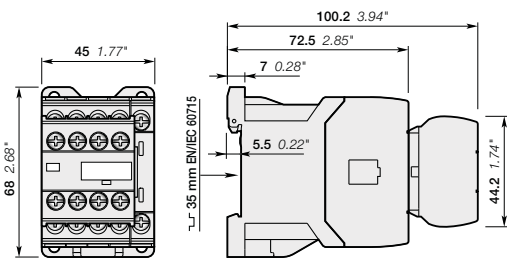

NS44E, NS53E, NS62E, NS71E, NS80E

NSL contactor relays

Main dimensions mm, inches

4-pole contactor relays

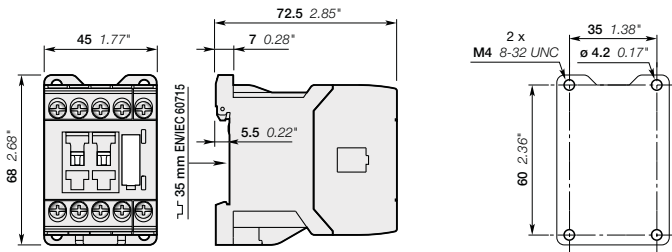

NSL22E, NSL31E, NSL40E

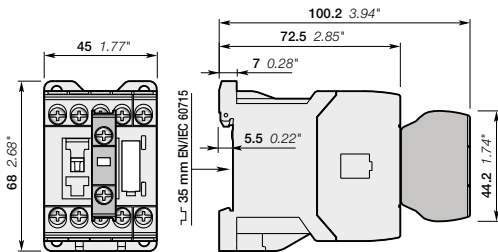

NSL22E, NSL31E, NSL40E

+ CA3 front-mounted 1-pole auxiliary contact block

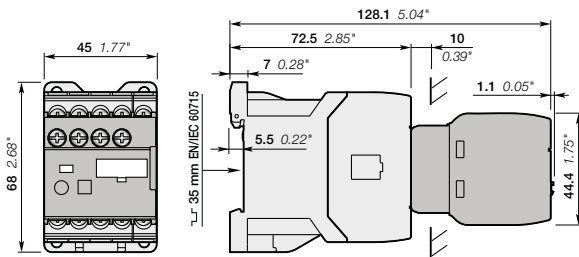

NSL22E, NSL31E, NSL40E

+ TEF3 electronic timer

8-pole contactor relays

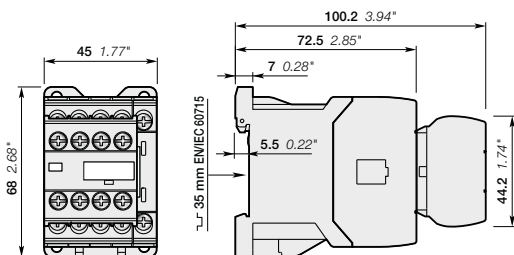

NSL44E, NSL53E, NSL62E, NSL71E, NSL80E

Auxiliary contact blocks

Accessories



CA3-10

1SBC101036F0014

Description

The auxiliary contact blocks are used for the operation of auxiliary circuits and control circuits.

CA3 1-pole auxiliary contact blocks, designed for standard industrial environments, are equipped with:

- N.O. or N.C. contacts.
- Screw-type connecting terminals with cage clamp delivered open.

All 1-pole auxiliary contact blocks are protected against accidental direct contact and bear the corresponding function marking.

A maximum of two 1-pole auxiliary contact blocks can be front-mounted on 1-stack contactors or 1-stack contactor relays.

Ordering details

For contactors	For contactor relays	Contact blocks	Type	Order code	Pkg qty	Weight (1 pce)
						kg

1-pole auxiliary contact blocks with screw terminals

AS09 ... AS16	NS, NSL	1 -	CA3-10	1SBN011010T1010	10	0.011
ASL09 ... ASL16		- 1	CA3-01	1SBN011010T1001	10	0.011

Main dimensions mm, inches

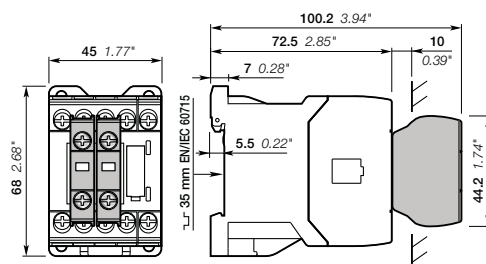

Auxiliary contact blocks

Technical data







Contact utilization characteristics according to IEC

Types	1-pole CA3	
Standards	IEC 60947-5-1 and EN 60947-5-1	
Rated insulation voltage U_i acc. to IEC 60947-5-1	690 V	
Rated impulse withstand voltage U_{imp}	6 kV	
Rated operational voltage U_e max.	690 V	
Conventional thermal current $I_{th} - \theta \leq 40^\circ\text{C}$	10 A	
le / Rated operational current AC-15 acc. to IEC 60947-5-1	24-127 V 50/60 Hz	6 A
	220-240 V 50/60 Hz	4 A
	400-440 V 50/60 Hz	3 A
	500 V 50/60 Hz	2 A
	690 V 50/60 Hz	2 A
Making capacity	10 x I_e AC-15 acc. to IEC 60947-5-1	
Breaking capacity	10 x I_e AC-15 acc. to IEC 60947-5-1	
le / Rated operational current DC-13 acc. to IEC 60947-5-1	24 V DC	6 A / 144 W
	48 V DC	2.8 A / 134 W
	72 V DC	1 A / 72 W
	110 V DC	0.55 A / 60 W
	125 V DC	0.55 A / 69 W
	220 V DC	0.27 A / 60 W
	250 V DC	0.27 A / 68 W
Short-circuit protection device gG type fuse	10 A	
Rated short-time withstand current I_{cw} $\theta = 40^\circ\text{C}$	for 1.0 s	100 A
	for 0.1 s	140 A
Minimum switching capacity with failure rate acc. to IEC 60947-5-4	12 V / 3 mA	
Power dissipation per pole at 6 A	0.1 W	
Mechanical durability	10 millions operating cycles	
Number of operating cycles	3600 cycles/h	
Max. switching frequency		
Max. electrical switching frequency	AC-15	1200 cycles/h
	DC-13	900 cycles/h
Mechanically linked contacts acc. to annex L of IEC 60947-5-1	Additional N.O. or N.C. auxiliary contacts (CA3) are mechanically linked contacts	
Mirror contacts acc. to annex F of IEC 60947-4-1	Additional N.C. auxiliary contacts (CA3) are mirror contacts	

Contact utilization characteristics according to UL / CSA

Standards	UL 508, CSA C22.2 N°14	
Max. operational voltage	690 V AC, 250 V DC	
Pilot duty	A600, Q300	
AC thermal rated current	10 A	
AC maximum volt-ampere making	7200 VA	
AC maximum volt-ampere breaking	720 VA	
DC thermal rated current	2.5 A	
DC maximum volt-ampere making-breaking	69 VA	

Connecting characteristics

Connection capacity (min. ... max.)		
	Rigid solid	1 x 0.75...2.5 mm ²
	Flexible with non insulated ferrule	2 x 0.75...2.5 mm ²
		1 x 0.75...2.5 mm ²
	Flexible with insulated ferrule	2 x 0.75...2.5 mm ²
		1 x 0.75...2.5 mm ²
	Lugs	L ≤ 7.7 mm
		I > 3.2 mm
Connection capacity acc. to UL / CSA		1 or 2 x AWG 18...14
Stripping length		9 mm
Tightening torque		Recommended 1 Nm / 9 lb.in
		Max. 1.20 Nm
Degree of protection		
acc. to IEC 60947-1 / EN 60947-1 and IEC 60529 / EN 60529		IP20
Screw terminals		
All terminals		Delivered in open position, screws of unused terminals must be tightened
		M3
Screwdriver type		
		Flat Ø 5.5 / Pozidriv 2

Auxiliary contact blocks for AS09 ... AS16, ASL09 ... ASL16 contactors and NS, NSL contactor relays

Electrical durability

Electrical durability for AC-15 utilization category - $U_e \leq 400\text{ V}$

AC-15 utilization category according to IEC 60947-5-1 / EN 60947-5-1:

- making current: $10 \times I_e$ with $\cos \phi = 0.7$ and U_e
- breaking current: I_e with $\cos \phi = 0.4$ and U_e .

This curve represents the electrical durability of the built-in or add-on auxiliary contacts in relation to the breaking current.

The curve has been drawn for resistive and inductive loads up to 400 V:

- AS09 ... AS16 and ASL09 ... ASL16 contactor built-in auxiliary contacts
- 1-pole CA3
- NS and NSL contactor relays.

4

Millions of
operating
cycles

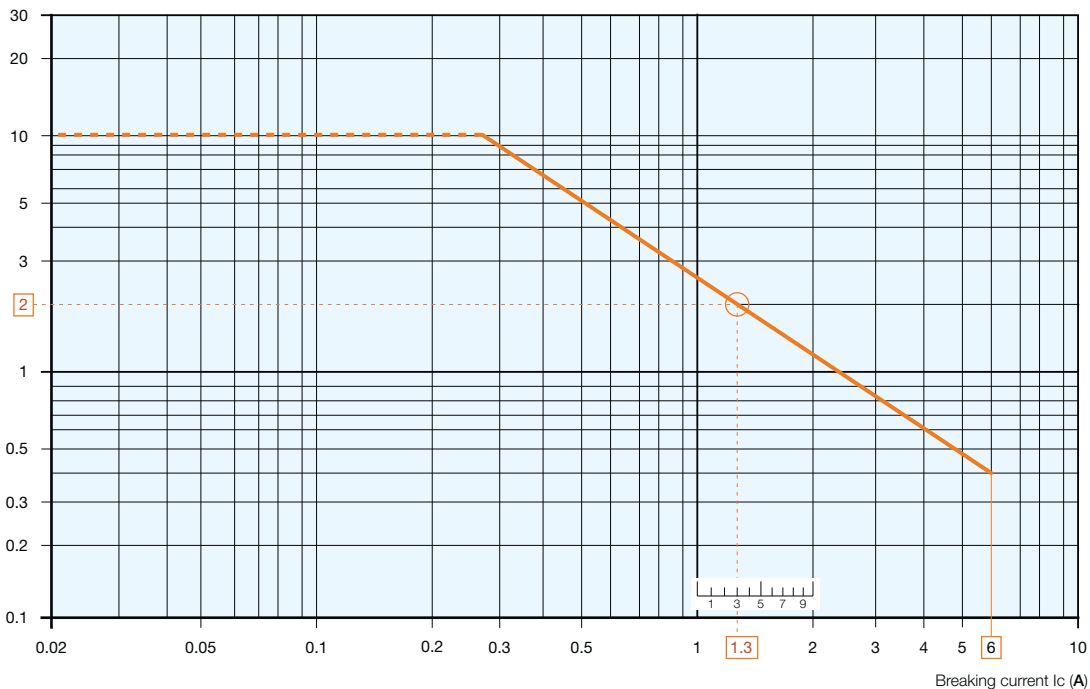

Example:

Breaking current = 1.3 A

On the opposite curve at intersection "○" 1.3 A the corresponding value for the electrical durability is approximately 2 millions operating cycles.

Electronic timers



TEF3-ON

1SBC101337F0010



TEF3-OFF

1SBC101336F0010

Description

TEF3 frontal electronic timers are used for realizing timing function and are available in ON-delay and OFF-delay versions.

Compact solution in cabinet compared to separate timers

TEF3 electronic timers are front-mounted and locked on AS/ASL contactors or NS/NSL contactor relays. A mechanical indicator allows to show the state of the contactor.

Safe and cost-reduced wiring

TEF3 electronic timers are supplied by a direct plug-in parallel connection to the coil terminals A1 - A2 of the contactor or contactor relay. A varistor is integrated on the timer to offer a built-in protection against surges in the contactor coil.

Available for a wide control voltage range 24...240 V AC/DC

TEF3-ON or TEF3-OFF allow time-delayed functions up to 100 s in 3 distinct time ranges, independently of the control system. The time delay ranges are selected by a switch and the time delay can be adjusted by means of a rotary switch. The timing function is activated by closing or opening the device on which the timer is mounted. The OFF-delay version operates without additional control supply.

Ordering details

For contactors, contactor relays	Time delay range selected by switch	Delay type	Rated control circuit voltage U_c	Auxiliary contacts	Type	Order code	Weight Pkg (1 pce) kg
AS09 ... AS16	0.1...1 s	ON-delay	24...240	1 1	TEF3-ON	1SBN021012R1000	0.065
ASL09 ... ASL16	1...10 s						
NS, NSL	10...100 s	OFF-delay	24...240	1 1	TEF3-OFF	1SBN021014R1000	0.065

Main dimensions mm, inches

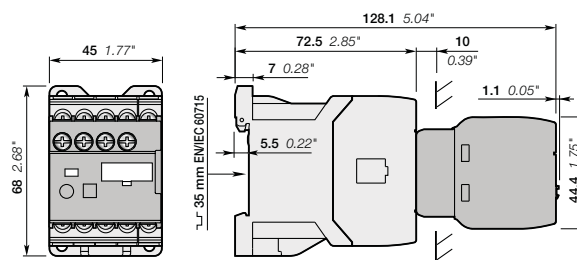

1SBC10150450201

Electronic timers

Technical data

Contact utilization characteristics according to IEC

Types	TEF3-ON	TEF3-OFF
Standards	IEC 60947-5-1 and EN 60947-5-1	
Rated insulation voltage U_i acc. to IEC 60947-5-1	400 V	
Rated impulse withstand voltage U_{imp}	4 kV	
Rated operational voltage U_e max.	240 V	
Rated frequency (without derating)	50 / 60 Hz	
Conventional thermal current $I_{th} - \theta \leq 40^\circ\text{C}$	5 A	
I_e / Rated operational current AC-15 acc. to IEC 60947-5-1	24-127 V 50/60 Hz	3 A
	220-240 V 50/60 Hz	1.5 A
Making capacity acc. to IEC 60947-5-1	10 x I_e AC-15	
Breaking capacity acc. to IEC 60947-5-1	10 x I_e AC-15	
I_e / Rated operational current DC-13 acc. to IEC 60947-5-1	24 V DC	1 A / 24 W
Short-circuit protection device gG type fuse	6 A	
Rated short-time withstand current I_{cw} $\theta = 40^\circ\text{C}$	for 1.0 s	8 A
	for 0.1 s	8 A
Minimum switching capacity with failure rate acc. to IEC 60947-5-4	24 V DC	12 V / 3 mA
Power dissipation per pole at 3 A	0.1 W	
Function diagram	ON-delay	OFF-delay
	Bistable relay inside. Before use, once apply U_c then switch it off in order to initialize position of the contacts.	
Control circuit voltage		
AC control voltage	Rated control circuit voltage U_c	24...240 V AC
50/60 Hz	Average consumption	1.5 mA RMS
DC control voltage	Rated control circuit voltage U_c	24...240 V DC
	Average consumption	1.5 mA
		1 mA
Rated frequency limits	50 / 60 Hz	
Supply voltage range	0.85...1.1 x U_c (at $\theta \leq 70^\circ\text{C}$)	
Overvoltage protection	Varistor included	
Time delay range (t) selected by switch	0.1...1 s	<input type="checkbox"/>
	1...10 s	<input type="checkbox"/>
	10...100 s	<input type="checkbox"/>
On-load reiteration accuracy under constant conditions	$\leq 1\%$	
Minimum ON period	0.1 s	
Recovery time	0.15 s	0.1 s
Ambient air temperature	Operation	-25 °C ... +70 °C
	Storage	-40 °C ... +80 °C
Climatic withstand	Category B according to IEC 60947-1 Annex Q	
Maximum operating altitude	2000 m	
Mounting positions	Mounting positions 1, 1 +/- 30°, 2, 3, 4, 5	
Shock withstand acc. to IEC 60068-2-27 and EN 60068-2-27	1/2 sinusoidal shock for 11 ms: no change in contact position	
(Mounting position 1)	Same as contactor or contactor relay	
Vibration withstand acc. to IEC 60068-2-6	5...300 Hz	
	3 g closed position / 2 g open position	
Mechanical durability	Number of operating cycles	5 millions operating cycles
	Max. switching frequency	3600 cycles/h
Max. electrical switching frequency		1800 cycles/h
	AC-15	1200 cycles/h
	DC-13	900 cycles/h





Electronic timers

Technical data

Contact utilization characteristics according to UL / CSA

Types	TEF3-ON	TEF3-OFF
Standards	UL 508, CSA C22.2 N°14	
Rated insulation voltage U_i acc. to UL / CSA	300 V	
Max. operational voltage	240 V	
Pilot duty	B300, R300	
AC thermal rated current	5 A	
AC maximum volt-ampere making	3600 VA	
AC maximum volt-ampere breaking	360 VA	
DC thermal rated current	1 A	
DC maximum volt-ampere making-breaking	28 VA	

Connecting characteristics

Connection capacity (min. ... max.)		
 Rigid solid	1 x	0.75...2.5 mm ²
	2 x	0.75...2.5 mm ²
 Flexible with non insulated ferrule	1 x	0.75...2.5 mm ²
	2 x	0.75...2.5 mm ²
 Flexible with insulated ferrule	1 x	0.75...2.5 mm ²
	2 x	0.75...1.5 mm ²
 Lugs	L ≤	7.7 mm
	I >	3.2 mm
Connection capacity acc. to UL / CSA	1 or 2 x	AWG 18...14
Stripping length		9 mm
Tightening torque	Recommended	1 N.m / 9 lb.in
	Max.	1.20 N.m
Degree of protection		IP20
acc. to IEC 60947-1 / EN 60947-1 and IEC 60529 / EN 60529		
Screw terminals	Delivered in open position, screws of unused terminals should be tightened	
All terminals	M3	
Screwdriver type	Flat Ø 5.5 / Pozidriv 2	
Terminal Marking		

Electrical durability for DC-13 utilization category

DC-13 utilization category according to IEC 60947-5-1 / EN 60947-5-1 : making and breaking current I_e and U_e .

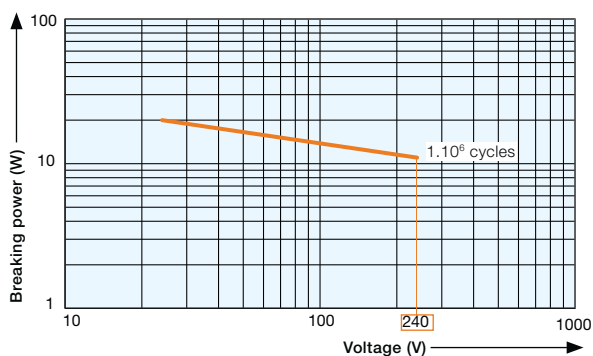

Surge suppressors for contactor coils

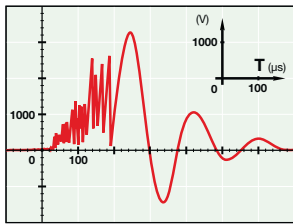

Description

The operation of inductive circuits causes overvoltages, in particular on opening the contactor coil. The electromagnetic energy stored in the coil during contactor closing is restored on opening in the form of surges, the slope and amplitude of which may rise to several kilovolts. A number of drawbacks are observed ranging from interference on the electronic devices to the breakdown of insulators and even the destruction of certain sensitive components.

The graph opposite reproduces the oscillogram showing voltage discharges at the terminals of a 42 V / 50 Hz coil without peak clipping. The coil was switched by 8 series-connected poles of a contactor relay.

Following a burst of discharges with a very steep slope, a damped oscillation emerges with a peak value of 3500 V.

Overvoltage Factor

The overvoltage factor k is defined as the ratio of the maximum overvoltage peak value \hat{U}_s to the peak value \hat{U}_c of the coil rated control voltage U_c :

$$k = \frac{\hat{U}_s \text{ max.}}{\hat{U}_c} \quad \text{in DC} \quad k = \frac{\hat{U}_s \text{ max.}}{U_c} \quad \text{in AC} \quad k = \frac{\hat{U}_s \text{ max.}}{U_c \sqrt{2}}$$

For example the following is obtained for the above graph: $k = \frac{3500}{42 \sqrt{2}} \approx 60$

To reduce the harmful effects of these overvoltages, ABB has developed a range of surge suppressors designed to reduce the k factor defined above and to limit or even completely eliminate the high pre-damping voltage frequencies.

Each case is different, but the technical data tolerances and generous sizing of parts have enabled us to reduce the number of variants.

We have chosen the following solutions: transil diodes, varistors and RC blocks.

Note: A varistor is a resistor whose value decreases to a very large extent when a certain voltage is applied at its terminals.

Ordering details

For contactors	For contactor relays	Rated control circuit voltage - U_c			Type	Order code	Pkg qty	Weight (1 pce) kg
		V	AC	DC				
AS, ASL	NS, NSL	24...50	●	●	RV5/50	1SBN050010R1000	2	0.015
		50...133	●	●	RV5/133	1SBN050010R1001	2	0.015
		110...250	●	●	RV5/250	1SBN050010R1002	2	0.015
		250...440	●	●	RV5/440	1SBN050010R1003	2	0.015
AS	NS	24...50	●	-	RC5-1/50	1SBN050100R1000	2	0.012
		50...133	●	-	RC5-1/133	1SBN050100R1001	2	0.012
		110...250	●	-	RC5-1/250	1SBN050100R1002	2	0.012
		250...440	●	-	RC5-1/440	1SBN050100R1003	2	0.012
ASL	NSL	12...32	-	●	RT5/32	1SBN050020R1000	2	0.015
		25...65	-	●	RT5/65	1SBN050020R1001	2	0.015
		50...90	-	●	RT5/90	1SBN050020R1002	2	0.015
		77...150	-	●	RT5/150	1SBN050020R1003	2	0.015
		150...264	-	●	RT5/264	1SBN050020R1004	2	0.015

Main dimensions mm, inches

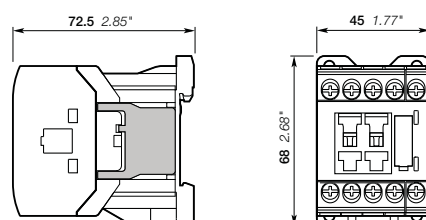

Easy connection to the coil terminals
(parallel mounting)
Clip-on for both fixing and connection.

No additional space
Clipped onto the right side part of the contactor base without changing contactor overall dimensions and keeping a free access to coil terminals.

1SBC101494S0201



RV5



RC5-1



RT5

Surge suppressors for contactor coils

Technical data

Varistor	RV5/50	RV5/133	RV5/250	RV5/440
Rated control circuit voltage U_c	24...50 V AC	50...133 V AC	110...250 V AC	250...440 V AC
Residual overvoltage (clipping voltage)	24...50 V DC	50...133 V DC	110...250 V DC	250...440 V DC
	132 V AC	270 V AC	480 V AC	825 V AC
	132 V DC	270 V DC	480 V DC	825 V DC
Opening time growth factor	none			
Operating temperature	-20...+70 °C			
Advantages	High energy absorption: good damping - Unpolarized system			
Drawback	Clipping as from U_{vdr}^* , thus voltage front up to this point			
	* U_{vdr} = Varistor operating voltage (voltage dependent resistor), tolerance $\pm 10\%$			

RC type	RC5-1/50	RC5-1/133	RC5-1/250	RC5-1/440
Rated control circuit voltage U_c	24...50 V AC	50...133 V AC	110...250 V AC	250...440 V AC
Residual overvoltage (clipping voltage)	2 to 3 x U_c max.			
Opening time growth factor	2...3			
Operating temperature	-20...+70 °C			
Advantages	Very fast clipping - Attenuation of steep fronts and thus of high frequencies			

Transil diode	RT5/32	RT5/65	RT5/90	RT5/150	RT5/264
Rated control circuit voltage U_c	12...32 V DC	25...65 V DC	50...90 V DC	77...150 V DC	150...264 V DC
Residual overvoltage (clipping voltage)	50 V DC	100 V DC	150 V DC	210 V DC	390 V DC
Opening time growth factor	1.1...1.2				
Operating temperature	-20...+70 °C				
Advantages	Good energy absorption - Unpolarized system - Simple, reliable system				
Drawback	Delay on drop out which does not however reduce contactor breaking capacity				

Wiring diagrams

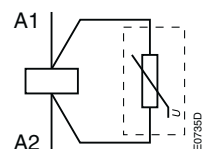

Varistor

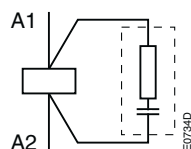

RC type

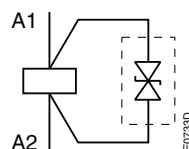

Transil diode

Mechanical interlock unit and other accessories



VM3



Mechanical interlock unit

When mounted between two contactors without additional width, the VM3 mechanical interlock unit prevents one of the contactors from closing as long as the other contactor is closed. The mechanical interlock unit includes 2 fixing clips.

Ordering details

For contactors		Type	Order code	Pkg qty	Weight (1 pce)
Left	Right				kg
AS	AS	VM3	1SBN031005T1000	10	0.002
ASL	ASL				

Note : VM3 mechanical durability, 5 millions of operating cycles on both reversing contactors.

Fixing clips

BB3 is a set of 50 fixing clips.

Ordering details

For contactors	Type	Order code	Pkg qty	Weight (1 pce)
				kg
AS, ASL	BB3	1SBN111020R1000	1	0.009

Test block

BDT4 test block is suitable for switching on contactor off-load. Marking on the block indicates the contactor type to fit with.

Ordering details

For contactors	Type	Order code	Pkg qty	Weight (1 pce)
				kg
AS, ASL, NS, NSL	BDT4	1SBN110122T1000	10	0.007

Function markers

Box of 16 blank cards (16 markers by card) printable on HTP500 thermal transfer printer and AMS 500 marking table to identify your contactors, overload relays or manual motor starters. Marker dimensions: 7 x 20 mm (.276" x .787").

Ordering details

For contactors	Type	Order code	Pkg qty	Weight (1 pce)
				kg
AS, ASL, NS, NSL	BA4	1SNA235156R2700	16	0.011
AMS 500 support plate for 8 BA4	SPRC 1	1SNA360010R1500	1	0.220
HTP500 support plate	HTP500-BA4	1SNA235712R2400	1	0.290



BDT4



BA4

1SNC160101F0014

Connection accessories for starting solutions

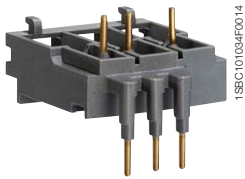

BEA16-3

1SBC101034F0014

Connecting links

The BEA16-3 insulated 3-pole connecting links are used to connect an AC or DC operated contactors with manual motor starters.

The connecting links ensure the electrical and mechanical connection between the contactor and the manual motor starter.

Ordering details

For contactors	Manual motor starter	Type	Order code	Pkg qty	Weight (1 pce) kg
AS09 ... AS16 ASL09 ... ASL16	MS116-0.16 ... MS116-16 MS132-0.16 ... MS132-16	BEA16-3	1SBN081006T1000	10	0.019

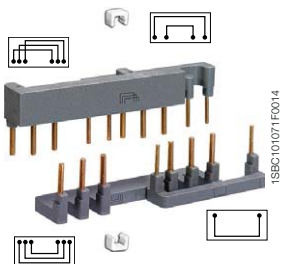

BER16C-3

1SBC101071F0014

Connection sets for reversing contactors

The BER16C-3 connection sets are used for the connections between the main poles of two 3-pole contactors mounted side by side as reversing contactors, including electrical interlocking between built-in N.C. auxiliary contact and coil terminals.

The connection sets are made up of:

- 1 upstream and 1 downstream connections: insulated, solid copper bars,
- 2 connections to realize electrical interlocking between contactors equipped with built-in N.C. auxiliary contacts,
- 2 fixing clips.

Ordering details

For contactors	Mechanical interlock unit	Type	Order code	Pkg qty	Weight (1 pce) kg
2 x AS09 ... AS16 2 x ASL09 ... ASL16	with or without VM3	BER16C-3	1SBN081012R1000	1	0.035

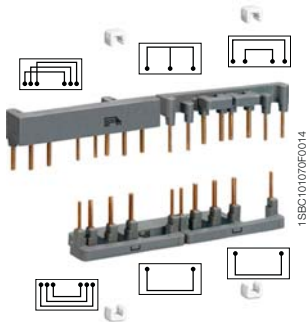

BEY16C-3

1SBC101070F0014

Connection sets for star-delta starting

BEY16C-3 connection sets are designed for star-delta starters whose contactors are assembled according to line delta star mounting.

The connection sets are made up of:

- Line contactor / delta contactor: upstream phase-to-phase connection,
- Delta contactor / star contactor: downstream connection in parallel,
- Star contactor: star point upstream,
- An electrical interlocking between delta and star contactors equipped with built-in N.C. auxiliary contacts,
- 4 fixing clips.

Ordering details

For contactors	Mech. interlock unit between star & delta contactors	Type	Order code	Pkg qty	Weight (1 pce) kg									
<table border="1"> <thead> <tr> <th>Line</th> <th>Delta</th> <th>Star</th> </tr> </thead> <tbody> <tr> <td>AS09</td> <td>AS09</td> <td>AS09</td> </tr> <tr> <td>AS12</td> <td>AS12</td> <td>AS09</td> </tr> </tbody> </table>	Line	Delta	Star	AS09	AS09	AS09	AS12	AS12	AS09	with or without VM3	BEY16C-3	1SBN081018R2000	1	0.041
Line	Delta	Star												
AS09	AS09	AS09												
AS12	AS12	AS09												

Voltage code table

The below tables indicate the available coil voltages and corresponding digits for order codes. When placing an order, please give either type or order code. Select a standard contactor from ordering detail pages. Change the **coil voltage code** in the type or in the order code according to the table below. Example: for contactor AS09-30-10 and coil 42 V 50/60 Hz, type is AS09-30-10-21 and order code is 1SBL101001R2110.

3-pole contactors

Type

AS16 - 30 - 10 - 26

Auxiliary contacts
N.O. N.C.

Main contacts
N.O. N.C.

Contactor type
AS AC operated
ASL DC operated

Order code

1SBL121001R 26 10

AC coil code

	50 Hz	60 Hz
20	24 V	24 V
21	42 V	42 V
22	48 V	48 V
23	110 V	110 V
24	115 V	115 V
16	-	120 V
25	220 V	220 V
26	230 V	230 V
27	240 V	240 V
17	-	277 V
13	380 V	-
28	400 V	400 V
29	415 V	415 V

DC coil code

80	12 V
81	24 V
83	48 V
84	60 V
86	110 V
87	125 V
88	220 V
89	240 V

3-pole reversing contactors

Type

VAS12 S EM - 26 M

Surge suppressor

Contactor type
VAS AC operated
VASL DC operated

Order code

1SBK113800M 26 00

AC coil code

	50 Hz	60 Hz
20	24 V	24 V
21	42 V	42 V
22	48 V	48 V
23	110 V	110 V
24	115 V	115 V
16	-	120 V
25	220 V	220 V
26	230 V	230 V
27	240 V	240 V
17	-	277 V
13	380 V	-
28	400 V	400 V
29	415 V	415 V

DC coil code

80	12 V (1)
81	24 V
83	48 V
84	60 V
86	110 V
87	125 V
88	220 V
89	240 V

(1) Not for VASL..SEM

Contactor relays

Type

NS 40 E - 26

N.O. N.C.
Number contacts

Contactor type
NS AC operated
NSL DC operated

Order code

1SBH101001R 26 40

AC coil code

	50 Hz	60 Hz
20	24 V	24 V
21	42 V	42 V
22	48 V	48 V
23	110 V	110 V
24	115 V	115 V
16	-	120 V
25	220 V	220 V
26	230 V	230 V
27	240 V	240 V
17	-	277 V
13	380 V	-
28	400 V	400 V
29	415 V	415 V

DC coil code

80	12 V
81	24 V
83	48 V
84	60 V
86	110 V
87	125 V
88	220 V
89	240 V

Notes

A series of horizontal dotted lines for taking notes, spanning the width of the page.

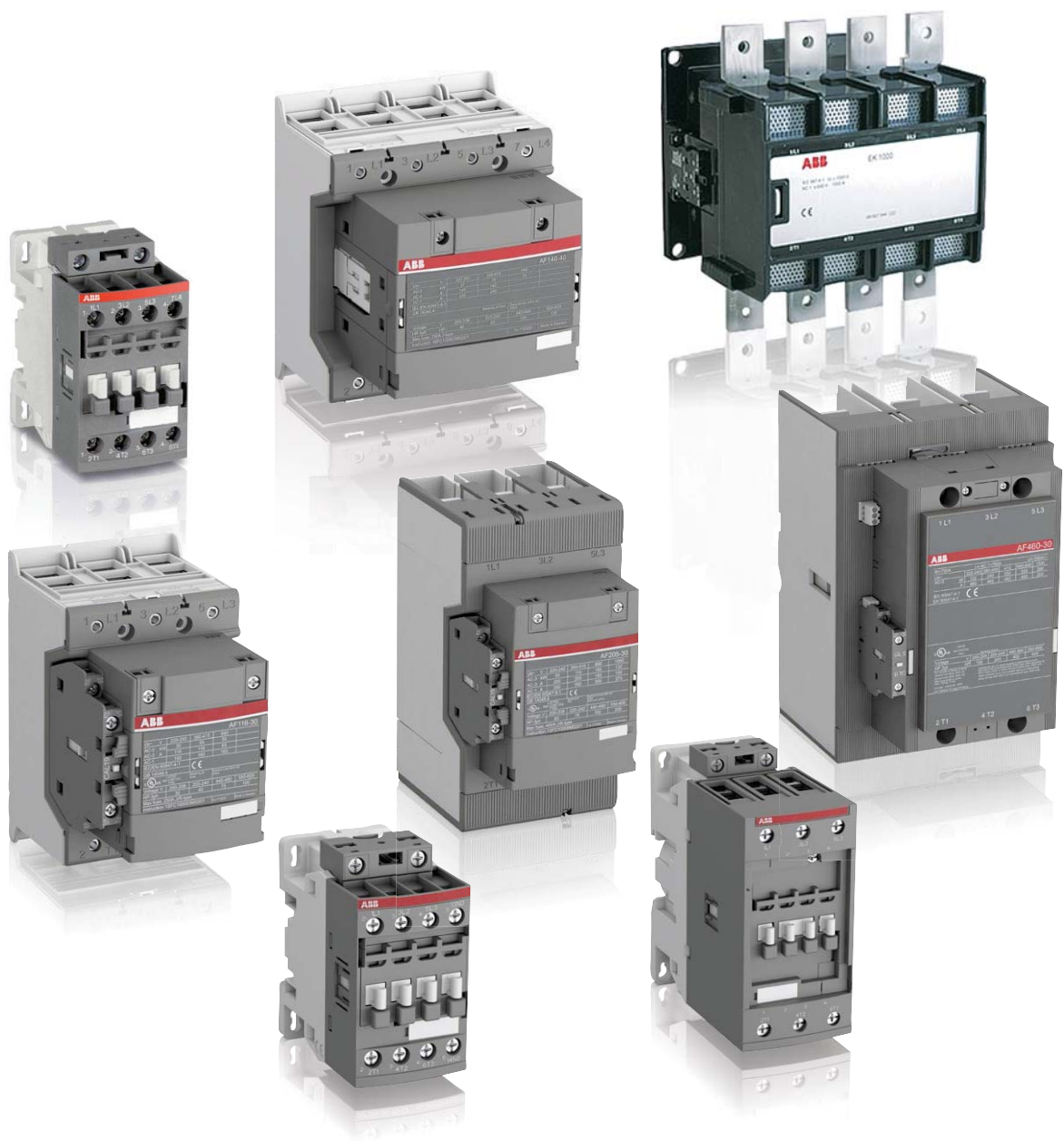

AF, EK contactors and NF contactor relays

Motor starting solution, in kit form

Contents	5/3
DOL and reversing starters protected by manual motor starters	5/4
DOL starters protected by moulded-case circuit-breakers	5/18
DOL and reversing starters protected by overload relays	5/34
Star-delta starters protected by overload relays	5/58

AF 3-pole contactors

Contents	5/81
Overview 3-pole contactors	5/82
Ordering details 3-pole contactors	5/84
Technical data 3-pole contactors	5/124
Terminal marking and positioning	5/149
Main dimensions	5/152

AF and EK 4-pole contactors

Contents	5/187
Overview 4-pole contactors	5/188
Ordering details 4-pole contactors	5/190
Technical data 4-pole contactors	5/214
Terminal marking and positioning	5/228
Main dimensions	5/231

Contactors for DC switching

Contents	5/247
AF and EK selection table for DC switching	5/248
Ordering details GA75 ... GAF2050	5/252
Technical data	5/258
Terminal marking and positioning	5/265
Main dimensions	5/266

Contactors for capacitor switching

Contents	5/273
Overview	5/275
UA16..RA up to UA110..RA - Unlimited peak current \hat{I}	5/276
UA16 up to UA110 - Peak current $\hat{I} \leq 100$ times the rms current	5/285
AF 3-pole contactors for capacitor switching – Selection table	5/295

Other contactor application data

	5/297
--	-------

NF contactor relays

Contents	5/317
Ordering details	5/318
Technical data	5/326
Terminal marking and positioning	5/329
Main dimensions	5/331

Accessories

Accessories for AF09 ... AF2650 contactors and NF contactor relays	5/335
Accessories for UA, UA..RA, GA and GAF contactors	5/375
Accessories for EK550, EK1000 contactors	5/399

Voltage code table

	5/410
--	-------

Questionnaire for product specifications

	5/414
--	-------

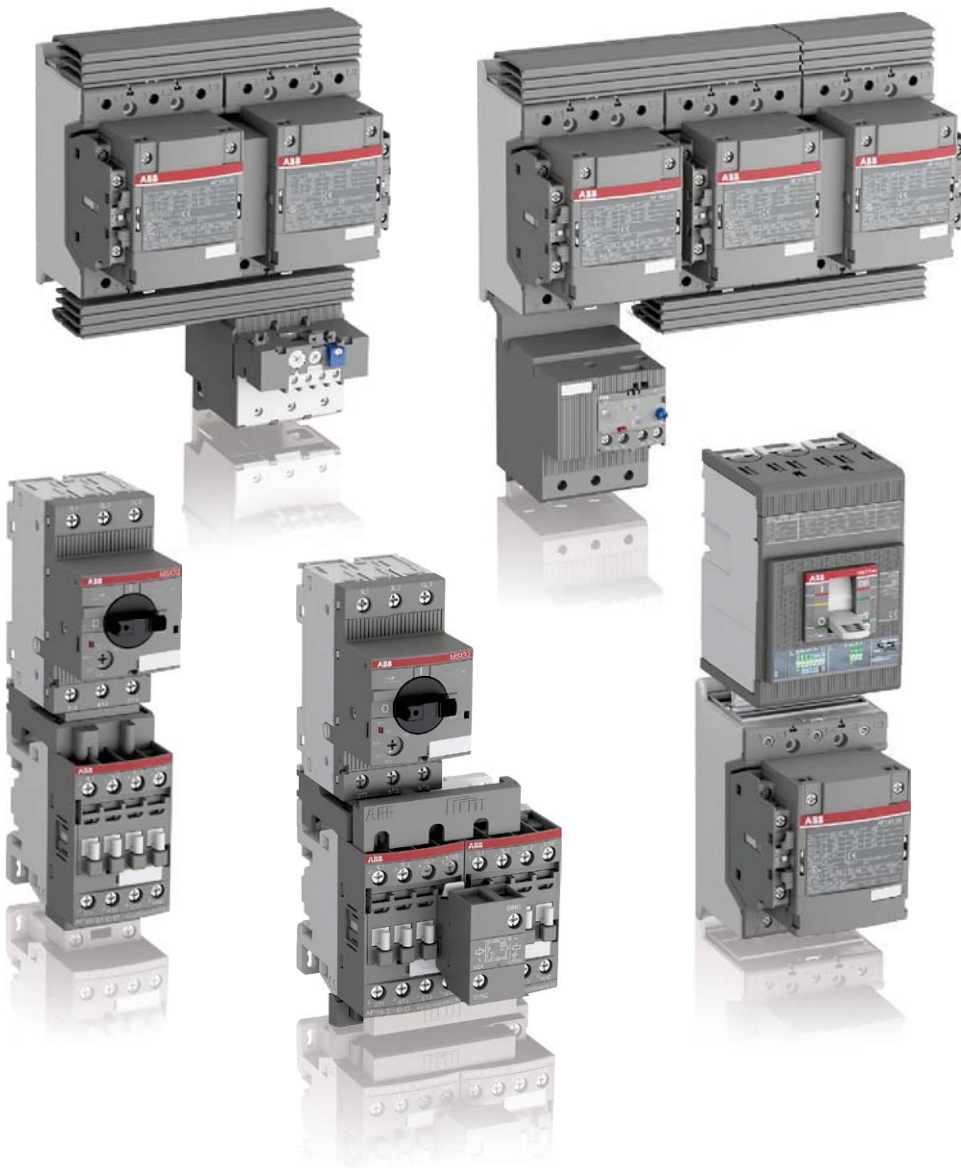

Motor starting solution, in kit form

DOL and reversing starters protected by manual motor starters

General	5/4
Selection tables	5/6
Wiring diagrams	5/10
Main dimensions	5/11

DOL starters protected by moulded-case circuit-breakers and overload relays

General	5/18
Selection tables	5/20
Wiring diagrams	5/24

Main dimensions, starter protected by

MCCB including motor protection	5/25
MCCB (magnetic only) and thermal overload relays	5/27
MCCB (magnetic only) and electronic overload relays	5/30

DOL and reversing starters protected by overload relays

General	5/34
Selection tables	5/36
Switching frequency diagrams for overload relays	5/40
Wiring diagrams	5/41

Main dimensions, starter protected by

Thermal overload relays	5/42
Electronic overload relays	5/48

Star-delta starters protected by overload relays

General	5/58
Selection tables	5/60
Switching frequency diagrams for overload relays	5/64
Wiring diagrams	5/65

Main dimensions, starter protected by

Thermal overload relays	5/67
Electronic overload relays	5/72

DOL and reversing starters protected by manual motor starters With AF contactors - open type version in kit form

5



1SFC101102V0001

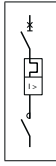

Application

Full voltage direct-on-line (DOL) starting and reversing starting for controlling three-phase asynchronous motors is a simple and economic solution characterised by a high starting torque (1.9 to 2.1 times full-speed torque) and a starting current 5.5 to 7 times nominal current.

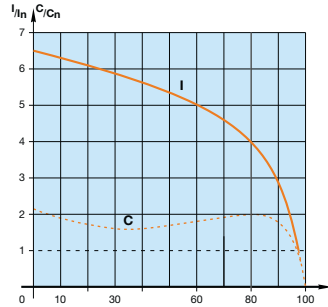

I = current
C = torque
In = nominal current
Cn = nominal torque

DOL starter

MS132-10 + BEA16-4 + AF09-30-10

Coordination types

The contactor and the manual motor starter control and protect motors against overload and short-circuits according to coordination types 1 and 2 (IEC 60947-4-1 / EN 60947-4-1) defining the anticipated level of service continuity as follow:

Type 1: In short-circuit conditions, the contactor or starter does not endanger persons or installations and will not be able to then operate without being repaired or having parts replaced.

Type 2: In short-circuit conditions, the contactor or starter does not endanger persons or installations and will be able to operate afterwards. The risk of contacts light welding is acceptable.



1SFC101105V0001

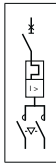

Main Technical Data

Standards	IEC 60947-4-1 / EN 60947-4-1	
Rated operational voltage Ue max.	690 V - 50/60 Hz	
Rated insulation voltage Ui		
acc. to IEC 60947-4-1	690 V	
acc. to UL / CSA	600 V	
Switching frequency		
	≤ 15 starts/hour - 80 % max. load factor - with max. 1.5 s starting time	
	≤ 30 starts/hour - 50 % max. load factor - with max. 1.5 s starting time	
Ambient air temperature		
Close to the device	use with MS116	≤ 55 °C
	use with MS132, MS165, MS495	≤ 60 °C
Degree of protection	IP20	

Reversing starter

MS132-10 + BEA16-4 + BER16-4 + VEM4 + AF09-30-10

Mounting positions

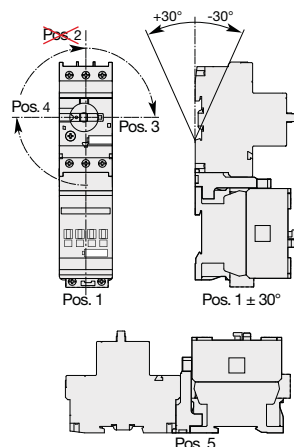

DOL starters

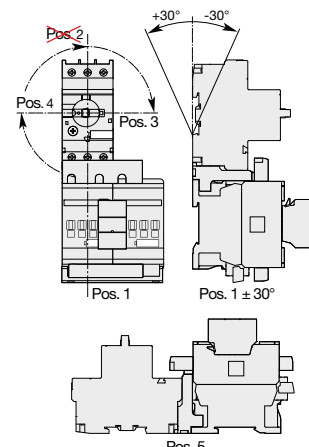

Reversing starters

DOL and reversing starters protected by manual motor starters With AF contactors - open type version in kit form

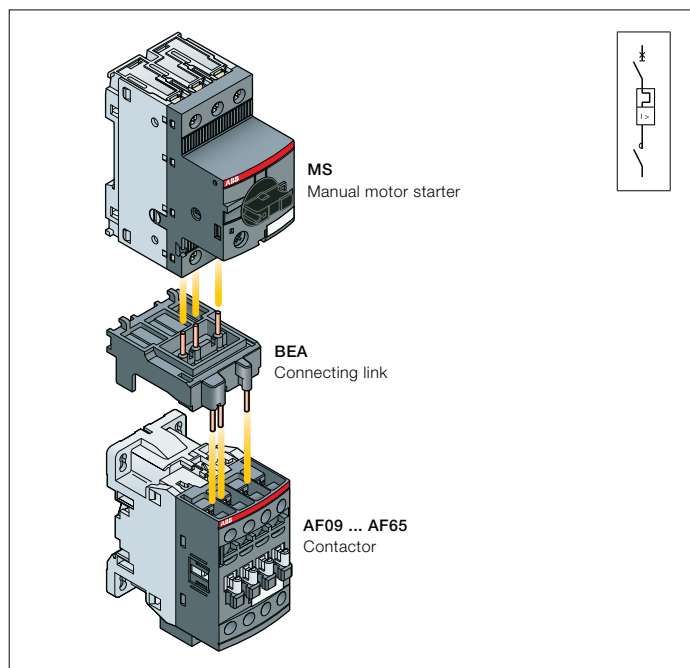

Direct-on-line starters

Description

You can easily assemble a direct-on-line starter by using the BEA...-4 connecting link 3-pole insulated. It is used to electrically and mechanically connect MS116, MS132 or MS165 manual motor starter and AF09 ... AF65 contactor, AC or DC operated.

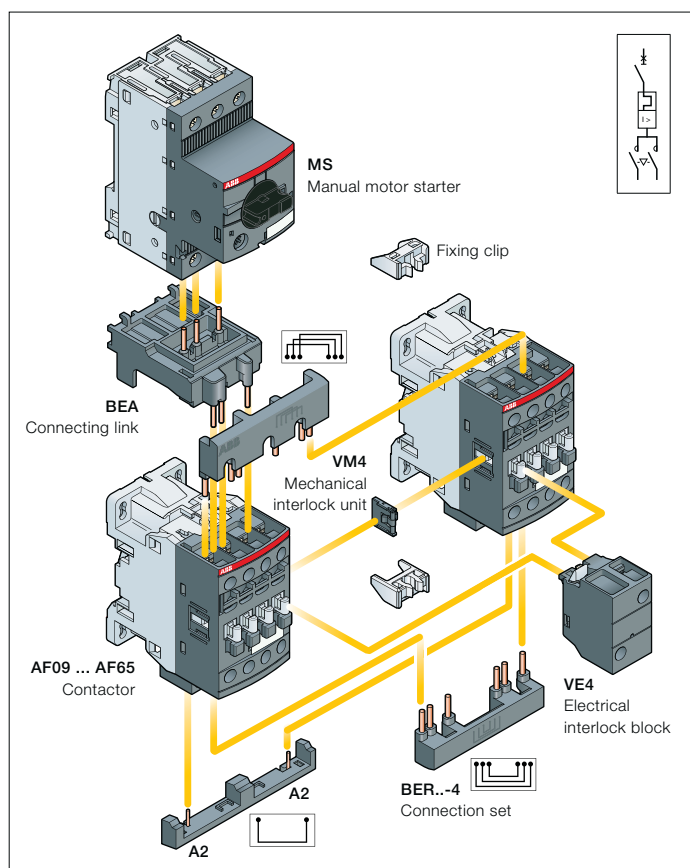

Reversing starters

Description

You can easily assemble reversing starter thanks to our complete range of accessories:

- BEA...-4 connecting link 3-pole insulated: it is used to electrically and mechanically connect MS116, MS132 or MS165 manual motor starter and AF09 ... AF65 contactor, AC or DC operated
- For AF09 ... AF38, use VEM4 mechanical and electrical interlock set for reversing starter in 90 mm width. It includes:
 - VM4 mechanical interlock unit including 2 fixing clips
 - VE4 electrical interlock block with A2-A2 connection.
- For AF40 ... AF96, use VM96-4 mechanical interlock unit and additional auxiliary contact blocks for electrical interlocking
- BER...-4 connection set: it assures a safe and simple reversing connection between both contactor main terminals.

Select now easily and quickly your starter in the following pages for coordination type 1 or 2 at 400 V, 50/60 Hz, I_q = 16 kA up to 18.5 kW and I_q = 50 kA up to 45 kW.



For the full coordination tables:

www.abb.com/lowvoltage then go to the right menu: "Support", select: "Online Product Selection Tools" then select "Coordination Tables for motor protection"

DOL starters protected by MS manual motor starters

Coordination type 1

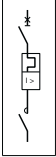
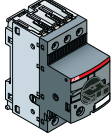
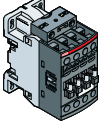
Coordination type 1, AC-3, 16 kA or 50 kA, 400 V, 50/60 Hz

		Manual motor starters					Contactors					Accessories	
												 	
IEC	Type	Order code	Current setting range	Magnetic tripping current	Rated control circuit voltage	Type	Order code	Allowed setting current	Type	Order code			
AC-3, 400 V	(1)		A	A	Uc min. ... Uc max.	(3)		A					
Rated power	current				V 50/60 Hz	V DC							
kW	A												
0.06	0.2	MS132-0.25	1SAM350000R1002	0.16...0.25	2.44	24...60	20...60	AF09Z-30-10-21	1SBL136001R2110	0.25	BEA16-4	1SBN081306T1000	
						100...250	100...250	AF09-30-10-13	1SBL137001R1310				
0.09	0.3	MS132-0.4	1SAM350000R1003	0.25...0.40	3.9	24...60	20...60	AF09Z-30-10-21	1SBL136001R2110	0.4			
						100...250	100...250	AF09-30-10-13	1SBL137001R1310				
0.12	0.44	MS132-0.63	1SAM350000R1004	0.40...0.63	6.14	24...60	20...60	AF09Z-30-10-21	1SBL136001R2110	0.63			
						100...250	100...250	AF09-30-10-13	1SBL137001R1310				
0.18	0.6	MS132-0.63	1SAM350000R1004	0.40...0.63	6.14	24...60	20...60	AF09Z-30-10-21	1SBL136001R2110	0.63			
						100...250	100...250	AF09-30-10-13	1SBL137001R1310				
0.25	0.85	MS132-1.0	1SAM350000R1005	0.63...1.00	11.5	24...60	20...60	AF09Z-30-10-21	1SBL136001R2110	1			
						100...250	100...250	AF09-30-10-13	1SBL137001R1310				
0.37	1.1	MS132-1.6	1SAM350000R1006	1.00...1.60	18.4	24...60	20...60	AF09Z-30-10-21	1SBL136001R2110	1.6			
						100...250	100...250	AF09-30-10-13	1SBL137001R1310				
0.55	1.5	MS132-1.6	1SAM350000R1006	1.00...1.60	18.4	24...60	20...60	AF09Z-30-10-21	1SBL136001R2110	1.6			
						100...250	100...250	AF09-30-10-13	1SBL137001R1310				
0.75	1.9	MS132-2.5	1SAM350000R1007	1.60...2.50	28.75	24...60	20...60	AF09Z-30-10-21	1SBL136001R2110	2.5			
						100...250	100...250	AF09-30-10-13	1SBL137001R1310				
1.1	2.7	MS132-4.0	1SAM350000R1008	2.50...4.00	50	24...60	20...60	AF09Z-30-10-21	1SBL136001R2110	4			
						100...250	100...250	AF09-30-10-13	1SBL137001R1310				
1.5	3.6	MS132-4.0	1SAM350000R1008	2.50...4.00	50	24...60	20...60	AF09Z-30-10-21	1SBL136001R2110	4			
						100...250	100...250	AF09-30-10-13	1SBL137001R1310				
2.2	4.9	MS132-6.3	1SAM350000R1009	4.00...6.30	78.75	24...60	20...60	AF09Z-30-10-21	1SBL136001R2110	6.3			
						100...250	100...250	AF09-30-10-13	1SBL137001R1310				
3	6.5	MS132-10	1SAM350000R1010	6.30...10.0	150	24...60	20...60	AF09Z-30-10-21	1SBL136001R2110	9			
						100...250	100...250	AF09-30-10-13	1SBL137001R1310				
4	8.5	MS132-10	1SAM350000R1010	6.30...10.0	150	24...60	20...60	AF09Z-30-10-21	1SBL136001R2110	9			
						100...250	100...250	AF09-30-10-13	1SBL137001R1310				
5.5	11.5	MS132-12	1SAM350000R1012	8.00...12.0	180	24...60	20...60	AF12Z-30-10-21	1SBL156001R2110	12			
						100...250	100...250	AF12-30-10-13	1SBL157001R1310				
7.5	15.5	MS132-16	1SAM350000R1011	10.0...16.0	240	24...60	20...60	AF16Z-30-10-21	1SBL176001R2110	16			
						100...250	100...250	AF16-30-10-13	1SBL177001R1310				
11	22	MS132-25	1SAM350000R1014	20.0...25.0	375	24...60	20...60	AF26Z-30-00-21	1SBL236001R2100	25	+ BEA38-4 CA4-10	1SBN082306T2000 1SBN010110R1010	
						100...250	100...250	AF26-30-00-13	1SBL237001R1300				
15	29	MS132-32	1SAM350000R1015	25.0...32.0	480	24...60	20...60	AF30Z-30-00-21	1SBL276001R2100	32			
						100...250	100...250	AF30-30-00-13	1SBL277001R1300				
18.5	35	MS165-42	1SAM451000R1015	30.0...42.0	630	24...60	20...60	AF40-30-00-11	1SBL347001R1100	40	BEA65-4 CA4-10	1SBN083406R1000 1SBN010110R1010	
						100...250	100...250	AF40-30-00-13	1SBL347001R1300				
22	41	MS165-54	1SAM451000R1016	40.0...54.0	810	24...60	20...60	AF52-30-00-11	1SBL367001R1100	53			
						100...250	100...250	AF52-30-00-13	1SBL367001R1300				
30	55	MS165-65	1SAM451000R1017	52.0...65.0	975	24...60	20...60	AF65-30-00-11	1SBL387001R1100	65			
						100...250	100...250	AF65-30-00-13	1SBL387001R1300				
37	66	MS495-75	1SAM550000R1008	57.0...75.0	975	24...60	20...60	AF80-30-00-11	1SBL397001R1100	75			
						100...250	100...250	AF80-30-00-13	1SBL397001R1300				
45	80	MS495-90	1SAM550000R1009	70.0...90.0	1170	24...60	20...60	AF96-30-00-11	1SBL407001R1100	90			
						100...250	100...250	AF96-30-00-13	1SBL407001R1300				

(1) MS116 manual motor starter can be selected according to the current setting range indicated on the coordination line, up to:

- 15 kW, 400 V - AC-3 at 16 kA
- 4 kW, 400 V - AC-3 at 50 kA.



(2) For other control voltages, see "Voltage code table".

(3) AF38 3-pole contactor can be selected for coordination type 1, 16 kA and 50 kA, 18.5 kW, 400 V - AC-3 (BEA65-4 available for AF40 ... AF65 only).

DOL starters protected by MS manual motor starters

Coordination type 2

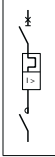
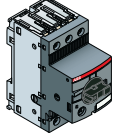
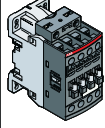
Coordination type 2, AC-3, 16 kA or 50 kA, 400 V, 50/60 Hz

		Manual motor starters					Contactors					Accessories	
												 	
IEC AC-3, 400 V Rated operational power kW	Type (1)	Order code	Current setting range A	Magnetic tripping current A	Rated control circuit voltage Uc min. ... Uc max. (2)	Type (3)	Order code	Allowed setting current A	Type (4)	Order code			
					V 50/60 Hz V DC								
0.06	0.2	MS132-0.25 1SAM350000R1002	0.16...0.25	2.44	24...60 20...60	AF09Z-30-10-21 1SBL136001R2110	0.25		BEA16-4	1SBN081306T1000			
0.09	0.3	MS132-0.4 1SAM350000R1003	0.25...0.40	3.9	24...60 20...60	AF09Z-30-10-21 1SBL136001R2110	0.4						
0.12	0.44	MS132-0.63 1SAM350000R1004	0.40...0.63	6.14	24...60 20...60	AF09Z-30-10-21 1SBL136001R2110	0.63						
0.18	0.6	MS132-0.63 1SAM350000R1004	0.40...0.63	6.14	24...60 20...60	AF09Z-30-10-21 1SBL136001R2110	0.63						
0.25	0.85	MS132-1.0 1SAM350000R1005	0.63...1.00	11.5	24...60 20...60	AF09Z-30-10-21 1SBL136001R2110	1						
0.37	1.1	MS132-1.6 1SAM350000R1006	1.00...1.60	18.4	24...60 20...60	AF09Z-30-10-21 1SBL136001R2110	1.6						
0.55	1.5	MS132-1.6 1SAM350000R1006	1.00...1.60	18.4	24...60 20...60	AF09Z-30-10-21 1SBL136001R2110	1.6						
0.75	1.9	MS132-2.5 1SAM350000R1007	1.60...2.50	28.75	24...60 20...60	AF09Z-30-10-21 1SBL136001R2110	2.5						
1.1	2.7	MS132-4.0 1SAM350000R1008	2.50...4.00	50	24...60 20...60	AF26Z-30-00-21 1SBL236001R2100	4		+	BEA26-4 CA4-10	1SBN082306T1000 1SBN010110R1010		
1.5	3.6	MS132-4.0 1SAM350000R1008	2.50...4.00	50	24...60 20...60	AF26Z-30-00-21 1SBL236001R2100	4						
2.2	4.9	MS132-6.3 1SAM350000R1009	4.00...6.30	78.75	24...60 20...60	AF26Z-30-00-21 1SBL236001R2100	6.3						
3	6.5	MS132-10 1SAM350000R1010	6.30...10.0	150	24...60 20...60	AF26Z-30-00-21 1SBL236001R2100	10						
4	8.5	MS132-10 1SAM350000R1010	6.30...10.0	150	24...60 20...60	AF26Z-30-00-21 1SBL236001R2100	10						
5.5	11.5	MS132-12 1SAM350000R1012	8.00...12.0	180	24...60 20...60	AF26Z-30-00-21 1SBL236001R2100	12		+	BEA38-4 CA4-10	1SBN082306T2000 1SBN010110R1010		
7.5	15.5	MS132-16 1SAM350000R1011	10.0...16.0	240	24...60 20...60	AF30Z-30-00-21 1SBL276001R2100	16						
11	22	MS132-25 1SAM350000R1014	20.0...25.0	375	24...60 20...60	AF30Z-30-00-21 1SBL276001R2100	25						
15	29	MS132-32 1SAM350000R1015	25.0...32.0	480	24...60 20...60	AF30Z-30-00-21 1SBL276001R2100	32						
18.5	35	MS165-42 1SAM451000R1015	30.0...42.0	630	24...60 20...60	AF40-30-00-11 1SBL347001R1100	40			BEA65-4 CA4-10	1SBN083406R1000 1SBN010110R1010		
22	41	MS165-54 1SAM451000R1016	40.0...54.0	810	24...60 20...60	AF52-30-00-11 1SBL367001R1100	53						
30	55	MS165-65 1SAM451000R1017	52.0...65.0	975	24...60 20...60	AF65-30-00-11 1SBL387001R1100	65						
37	66	MS495-75 1SAM550000R1008	57.0...75.0	975	24...60 20...60	AF80-30-00-11 1SBL397001R1100	75						
45	80	MS495-90 1SAM550000R1009	70.0...90.0	1170	24...60 20...60	AF96-30-00-11 1SBL407001R1100	90						

(1) MS116 manual motor starter can be selected according to the current setting range indicated on the coordination line, up to
 - 15 kW 400V - AC-3 at 16 kA
 - 4 kW, 400 V - AC-3 at 50 kA.

(2) For other control voltages, see "Voltage code table".

(3) AF26 3-pole contactor can be selected for coordination type 2, 16 kA, 7.5 kW, 400 V - AC-3.

AF38 3-pole contactor can be selected for coordination type 2, 16 kA and 50 kA, 18.5 kW, 400 V - AC-3 (BEA65-4 available for AF40 ... AF65 only).

(4) BEA26-4 should be selected with MS116-12 ... MS116-16 and AF26 ... AF38.

BEA38-4 can only be selected with MS116-20 ... MS116-32.

Reversing starters protected by MS manual motor starters

Coordination type 1

Coordination type 1, AC-3, 16 kA or 50 kA, 400 V, 50/60 Hz

		Manual motor starters				Contactors				Accessories		
IEC	Type	Order code	Current setting range	Magnetic tripping current	Rated control circuit voltage	Type	Order code	Allowed setting current	Type	Order code		
AC-3, 400 V	(1)				Uc min. ... Uc max.	(3)		A				
Rated operational power					V 50/60 Hz : V DC							
kW	A		A	A				A				
0.06	0.2	MS132-0.25	1SAM35000R1002	0.16...0.25	2.44	24...60	20...60 AF09Z-30-10-21	1SBL136001R2110	0.25			
						100...250	100...250 AF09-30-10-13	1SBL137001R1310		+ BEA16-4	1SBN081306T1000	
0.09	0.3	MS132-0.4	1SAM35000R1003	0.25...0.40	3.9	24...60	20...60 AF09Z-30-10-21	1SBL136001R2110	0.4	+ BER16-4	1SBN081311R1000	
						100...250	100...250 AF09-30-10-13	1SBL137001R1310		+ VEM4	1SBN030111R1000	
0.12	0.44	MS132-0.63	1SAM35000R1004	0.40...0.63	6.14	24...60	20...60 AF09Z-30-10-21	1SBL136001R2110	0.63			
						100...250	100...250 AF09-30-10-13	1SBL137001R1310				
0.18	0.6	MS132-0.63	1SAM35000R1004	0.40...0.63	6.14	24...60	20...60 AF09Z-30-10-21	1SBL136001R2110	0.63			
						100...250	100...250 AF09-30-10-13	1SBL137001R1310				
0.25	0.85	MS132-1.0	1SAM35000R1005	0.63...1.00	11.5	24...60	20...60 AF09Z-30-10-21	1SBL136001R2110	1			
						100...250	100...250 AF09-30-10-13	1SBL137001R1310				
0.37	1.1	MS132-1.6	1SAM35000R1006	1.00...1.60	18.4	24...60	20...60 AF09Z-30-10-21	1SBL136001R2110	1.6			
						100...250	100...250 AF09-30-10-13	1SBL137001R1310				
0.55	1.5	MS132-1.6	1SAM35000R1006	1.00...1.60	18.4	24...60	20...60 AF09Z-30-10-21	1SBL136001R2110	1.6			
						100...250	100...250 AF09-30-10-13	1SBL137001R1310				
0.75	1.9	MS132-2.5	1SAM35000R1007	1.60...2.50	28.75	24...60	20...60 AF09Z-30-10-21	1SBL136001R2110	2.5			
						100...250	100...250 AF09-30-10-13	1SBL137001R1310				
1.1	2.7	MS132-4.0	1SAM35000R1008	2.50...4.00	50	24...60	20...60 AF09Z-30-10-21	1SBL136001R2110	4			
						100...250	100...250 AF09-30-10-13	1SBL137001R1310				
1.5	3.6	MS132-4.0	1SAM35000R1008	2.50...4.00	50	24...60	20...60 AF09Z-30-10-21	1SBL136001R2110	4			
						100...250	100...250 AF09-30-10-13	1SBL137001R1310				
2.2	4.9	MS132-6.3	1SAM35000R1009	4.00...6.30	78.75	24...60	20...60 AF09Z-30-10-21	1SBL136001R2110	6.3			
						100...250	100...250 AF09-30-10-13	1SBL137001R1310				
3	6.5	MS132-10	1SAM35000R1010	6.30...10.0	150	24...60	20...60 AF09Z-30-10-21	1SBL136001R2110	9			
						100...250	100...250 AF09-30-10-13	1SBL137001R1310				
4	8.5	MS132-10	1SAM35000R1010	6.30...10.0	150	24...60	20...60 AF09Z-30-10-21	1SBL136001R2110	9			
						100...250	100...250 AF09-30-10-13	1SBL137001R1310				
5.5	11.5	MS132-12	1SAM35000R1012	8.00...12.0	180	24...60	20...60 AF12Z-30-10-21	1SBL156001R2110	12			
						100...250	100...250 AF12-30-10-13	1SBL157001R1310				
7.5	15.5	MS132-16	1SAM35000R1011	10.0...16.0	240	24...60	20...60 AF16Z-30-10-21	1SBL176001R2110	16			
						100...250	100...250 AF16-30-10-13	1SBL177001R1310				
11	22	MS132-25	1SAM35000R1014	20.0...25.0	375	24...60	20...60 AF26Z-30-00-21	1SBL236001R2100	25			
						100...250	100...250 AF26-30-00-13	1SBL237001R1300		+ BEA38-4	1SBN082306T2000	
15	29	MS132-32	1SAM35000R1015	25.0...32.0	480	24...60	20...60 AF30Z-30-00-21	1SBL276001R2100	32	+ BER38-4	1SBN082311R1000	
						100...250	100...250 AF30-30-00-13	1SBL277001R1300		+ VEM4	1SBN030111R1000	
18.5	35	MS165-42	1SAM451000R1015	30.0...42.0	630	24...60	20...60 AF40-30-00-11	1SBL347001R1100	40	+ CA4-10	1SBN010110R1010	
						100...250	100...250 AF40-30-00-13	1SBL347001R1300		+ 2x		
22	41	MS165-54	1SAM451000R1016	40.0...54.0	810	24...60	20...60 AF52-30-00-11	1SBL367001R1100	53	+ BEA65-4	1SBN083406R1000	
						100...250	100...250 AF52-30-00-13	1SBL367001R1300		+ BER65-4	1SBN083411R1000	
30	55	MS165-65	1SAM451000R1017	52.0...65.0	975	24...60	20...60 AF65-30-00-11	1SBL387001R1100	65	+ VM96-4	1SBN033405T1000	
						100...250	100...250 AF65-30-00-13	1SBL387001R1300		+ 2x CA4-10	1SBN010110R1010	
37	66	MS495-75	1SAM55000R1008	57.0...75.0	975	24...60	20...60 AF80-30-00-11	1SBL397001R1100	75	+ CA4-01	1SBN010110R1001	
						100...250	100...250 AF80-30-00-13	1SBL397001R1300		+ 2x		
45	80	MS495-90	1SAM55000R1009	70.0...90.0	1170	24...60	20...60 AF96-30-00-11	1SBL407001R1100	90	+ 2x CA4-10	1SBN010110R1010	
						100...250	100...250 AF96-30-00-13	1SBL407001R1300		+ 2x CA4-01	1SBN010110R1001	

(1) MS116 manual motor starter can be selected according to the current setting range indicated on the coordination line, up to:

- 15 kW, 400 V - AC-3 at 16 kA
- 4 kW, 400 V - AC-3 at 50 kA.

(2) For other control voltages, see "Voltage code table".

(3) AF38 3-pole contactor can be selected for coordination type 1, 16 kA and 50 kA, 18.5 kW, 400 V - AC-3 (BEA65-4 available for AF40 ... AF65 only).

Reversing starters protected by MS manual motor starters

Coordination type 2

Coordination type 2, AC-3, 16 kA or 50 kA, 400 V, 50/60 Hz

		Manual motor starters					Contactors					Accessories			
IEC	Type	Order code	Current setting range	Magnetic tripping current	Rated control circuit voltage	Type	Order code	Allowed setting current	Type	Order code					
AC-3, 400 V	(1)		A	A	Uc min. ... Uc max.	(3)		A	(4)						
Rated operational power					(2)										
kW	A		A	A	V 50/60 Hz V DC										
0.06	0.2	MS132-0.25	1SAM350000R1002	0.16...0.25	2.44	24...60	20...60	AF09Z-30-10-21	1SBL136001R2110	0.25					
						100...250	100...250	AF09-30-10-13	1SBL137001R1310		+	BEA16-4	1SBN081306T1000		
0.09	0.3	MS132-0.4	1SAM350000R1003	0.25...0.40	3.9	24...60	20...60	AF09Z-30-10-21	1SBL136001R2110	0.4	+	BER16-4	1SBN081311R1000		
						100...250	100...250	AF09-30-10-13	1SBL137001R1310		+	VEM4	1SBN030111R1000		
0.12	0.44	MS132-0.63	1SAM350000R1004	0.40...0.63	6.14	24...60	20...60	AF09Z-30-10-21	1SBL136001R2110	0.63					
						100...250	100...250	AF09-30-10-13	1SBL137001R1310						
0.18	0.6	MS132-0.63	1SAM350000R1004	0.40...0.63	6.14	24...60	20...60	AF09Z-30-10-21	1SBL136001R2110	0.63					
						100...250	100...250	AF09-30-10-13	1SBL137001R1310						
0.25	0.85	MS132-1.0	1SAM350000R1005	0.63...1.00	11.5	24...60	20...60	AF09Z-30-10-21	1SBL136001R2110	1					
						100...250	100...250	AF09-30-10-13	1SBL137001R1310						
0.37	1.1	MS132-1.6	1SAM350000R1006	1.00...1.60	18.4	24...60	20...60	AF09Z-30-10-21	1SBL136001R2110	1.6					
						100...250	100...250	AF09-30-10-13	1SBL137001R1310						
0.55	1.5	MS132-1.6	1SAM350000R1006	1.00...1.60	18.4	24...60	20...60	AF09Z-30-10-21	1SBL136001R2110	1.6					
						100...250	100...250	AF09-30-10-13	1SBL137001R1310						
0.75	1.9	MS132-2.5	1SAM350000R1007	1.60...2.50	28.75	24...60	20...60	AF09Z-30-10-21	1SBL136001R2110	2.5					
						100...250	100...250	AF09-30-10-13	1SBL137001R1310						
1.1	2.7	MS132-4.0	1SAM350000R1008	2.50...4.00	50	24...60	20...60	AF26Z-30-00-21	1SBL236001R2100	4	+	BEA26-4	1SBN082306T1000		
						100...250	100...250	AF26-30-00-13	1SBL237001R1300		+	BER38-4	1SBN082311R1000		
1.5	3.6	MS132-4.0	1SAM350000R1008	2.50...4.00	50	24...60	20...60	AF26Z-30-00-21	1SBL236001R2100	4	+	VEM4	1SBN030111R1000		
						100...250	100...250	AF26-30-00-13	1SBL237001R1300		+ 2x	CA4-10	1SBN010110R1010		
2.2	4.9	MS132-6.3	1SAM350000R1009	4.00...6.30	78.75	24...60	20...60	AF26Z-30-00-21	1SBL236001R2100	6.3					
						100...250	100...250	AF26-30-00-13	1SBL237001R1300						
3	6.5	MS132-10	1SAM350000R1010	6.30...10.0	150	24...60	20...60	AF26Z-30-00-21	1SBL236001R2100	10					
						100...250	100...250	AF26-30-00-13	1SBL237001R1300						
4	8.5	MS132-10	1SAM350000R1010	6.30...10.0	150	24...60	20...60	AF26Z-30-00-21	1SBL236001R2100	10					
						100...250	100...250	AF26-30-00-13	1SBL237001R1300						
5.5	11.5	MS132-12	1SAM350000R1012	8.00...12.0	180	24...60	20...60	AF26Z-30-00-21	1SBL236001R2100	12	+	BEA38-4	1SBN082306T2000		
						100...250	100...250	AF26-30-00-13	1SBL237001R1300		+	BER38-4	1SBN082311R1000		
7.5	15.5	MS132-16	1SAM350000R1011	10.0...16.0	240	24...60	20...60	AF30Z-30-00-21	1SBL276001R2100	16	+	VEM4	1SBN030111R1000		
						100...250	100...250	AF30-30-00-13	1SBL277001R1300		+ 2x	CA4-10	1SBN010110R1010		
11	22	MS132-25	1SAM350000R1014	20.0...25.0	375	24...60	20...60	AF30Z-30-00-21	1SBL276001R2100	25					
						100...250	100...250	AF30-30-00-13	1SBL277001R1300						
15	29	MS132-32	1SAM350000R1015	25.0...32.0	480	24...60	20...60	AF30Z-30-00-21	1SBL276001R2100	32					
						100...250	100...250	AF30-30-00-13	1SBL277001R1300						
18.5	35	MS165-42	1SAM451000R1015	30.0...42.0	630	24...60	20...60	AF40-30-00-11	1SBL347001R1100	40	+	BEA65-4	1SBN083406R1000		
						100...250	100...250	AF40-30-00-13	1SBL347001R1300		+	BER65-4	1SBN083411R1000		
22	41	MS165-54	1SAM451000R1016	40.0...54.0	810	24...60	20...60	AF52-30-00-11	1SBL367001R1100	53	+	VM96-4	1SBN033405T1000		
						100...250	100...250	AF52-30-00-13	1SBL367001R1300		+ 2x	CA4-10	1SBN010110R1010		
30	55	MS165-65	1SAM451000R1017	52.0...65.0	975	24...60	20...60	AF65-30-00-11	1SBL387001R1100	65	+ 2x	CA4-01	1SBN010110R1001		
						100...250	100...250	AF65-30-00-13	1SBL387001R1300						
37	66	MS495-75	1SAM550000R1008	57.0...75.0	975	24...60	20...60	AF80-30-00-11	1SBL397001R1100	75	+	BER96-4	1SBN083911R1000		
						100...250	100...250	AF80-30-00-13	1SBL397001R1300		+	VM96-4	1SBN033405T1000		
45	80	MS495-90	1SAM550000R1009	70.0...90.0	1170	24...60	20...60	AF96-30-00-11	1SBL407001R1100	90	+ 2x	CA4-10	1SBN010110R1010		
						100...250	100...250	AF96-30-00-13	1SBL407001R1300		+ 2x	CA4-01	1SBN010110R1001		

(1) MS116 manual motor starter can be selected according to the current setting range indicated on the coordination line, up to

- 15 kW 400V - AC-3 at 16 kA
- 4 kW, 400 V - AC-3 at 50 kA.

(2) For other control voltages, see "Voltage code table".

(3) AF26 3-pole contactor can be selected for coordination type 2, 16 kA, 7.5 kW, 400 V - AC-3.

AF38 3-pole contactor can be selected for coordination type 2, 16 kA and 50 kA, 18.5 kW, 400 V - AC-3 (BEA65-4 available for AF40 ... AF65 only).

(4) BEA26-4 should be selected with MS116-12 ... MS116-16 and AF26 ... AF38.

BEA38-4 can only be selected with MS116-20 ... MS116-32.

DOL and reversing starters protected by manual motor starters

With AF contactors - open type version in kit form

Wiring diagrams

Direct-on-line starters

Power circuit

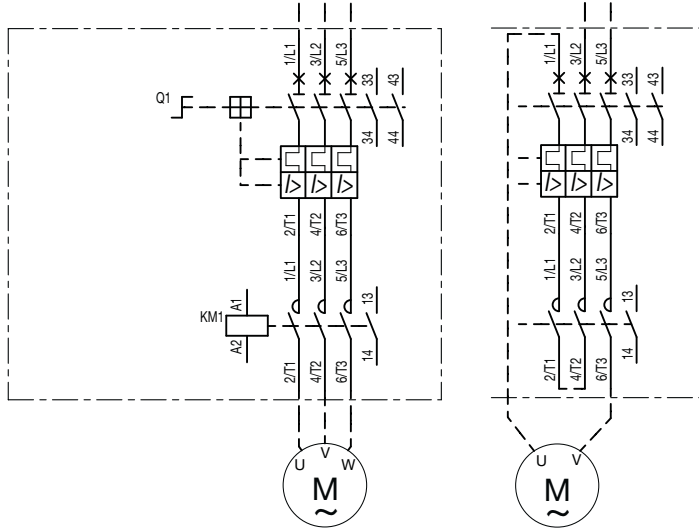

1-phase

AC or DC local control

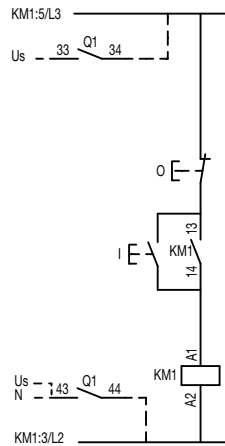

AC or DC remote control

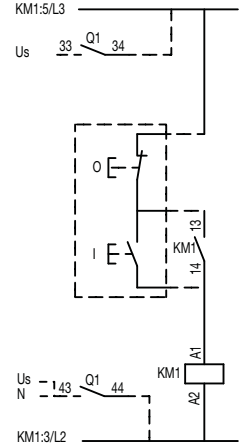

Note: coil U_c 12-20 V DC : A1+, A2-

Reversing starters

Power circuit

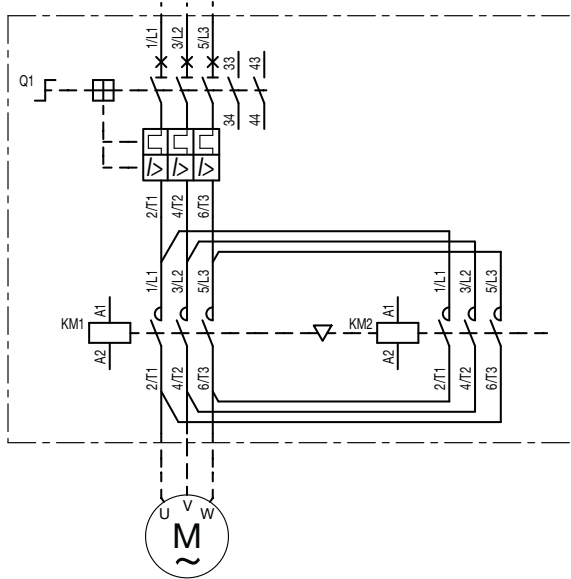

AC or DC local control

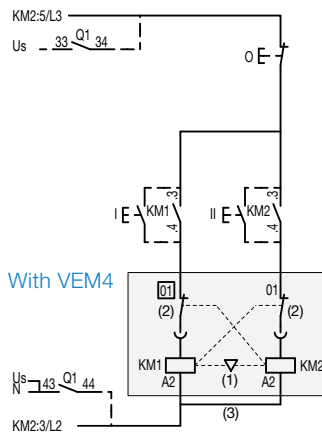

With VEM4

With VM

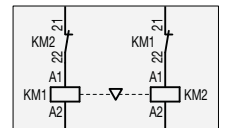

AC or DC remote control

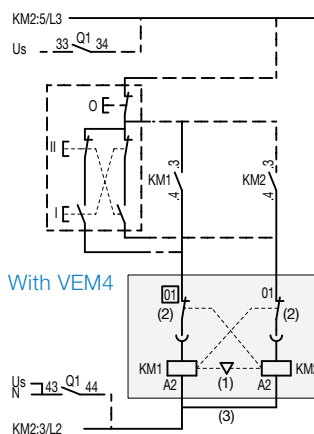

With VEM4

With VM

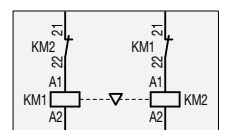

Note: - VEM4 = VM4 (1) + VE4 (2) with A2-A2 (3) connection
 (Except for coil U_c 12-20 V DC : use VM4 with CA4).
 - coil U_c 12-20 V DC : A1+, A2-

DOL starters protected by M116 manual motor starters With AF contactors - open type version in kit form

Main dimensions mm, inches

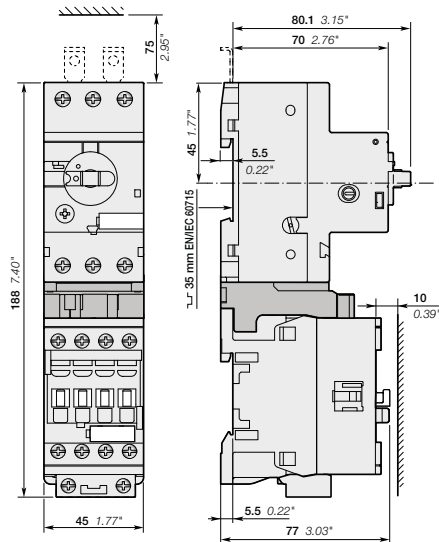

MS116-0.16 ... MS116-16
+ BEA16-4
+ AF09, AF12, AF16

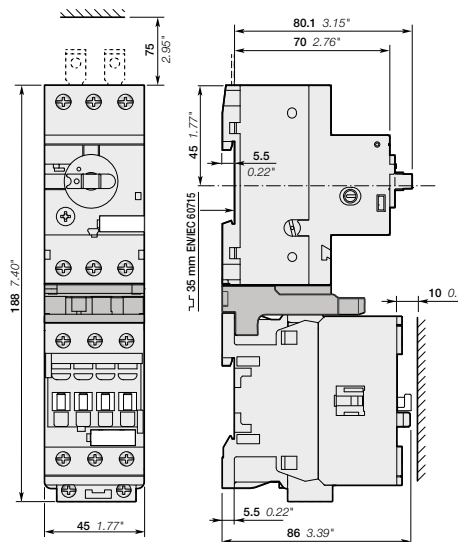

MS116-0.16 ... MS116-16
+ BEA26-4
+ AF26, AF30, AF38

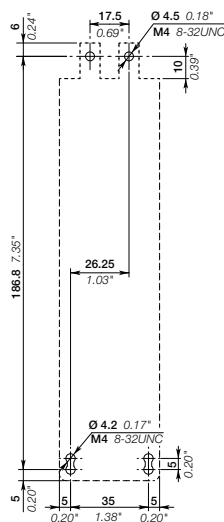

Note: contactor lateral distance to grounded component 2 mm 0.08" min.

DOL starters protected by M132 manual motor starters

With AF contactors - open type version in kit form

Main dimensions mm, inches

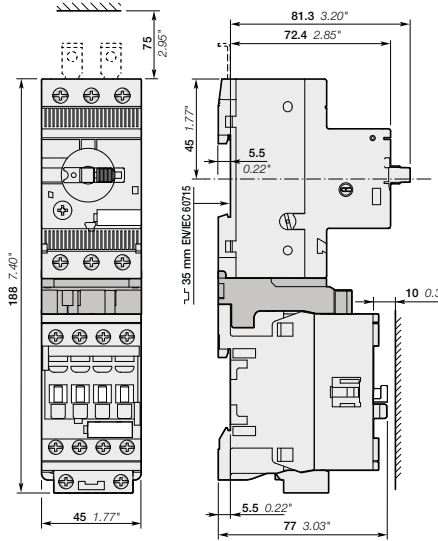

MS132-0.16 ... MS132-10
+ BEA16-4
+ AF09, AF12, AF16

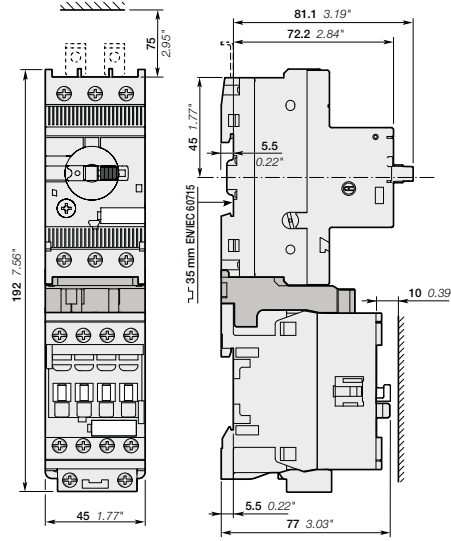

MS132-12 ... MS132-25
+ BEA16-4
+ AF09, AF12, AF16

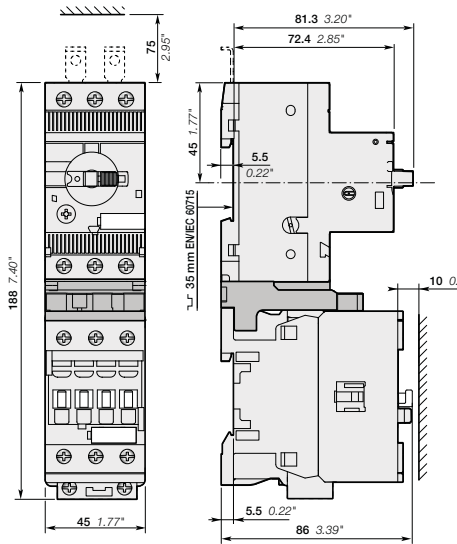

MS132-0.16 ... MS132-10
+ BEA26-4
+ AF26, AF30, AF38

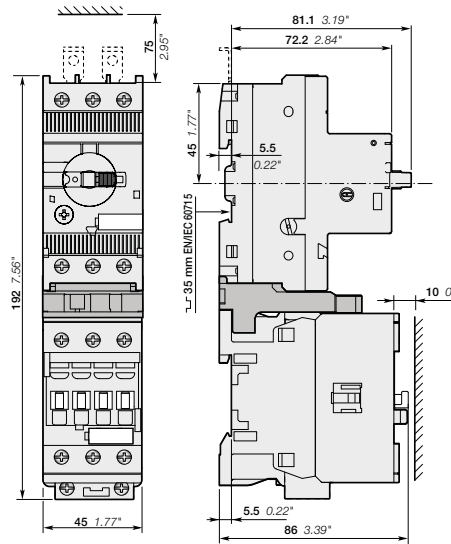

MS132-12 ... MS132-32
+ BEA38-4
+ AF26, AF30, AF38

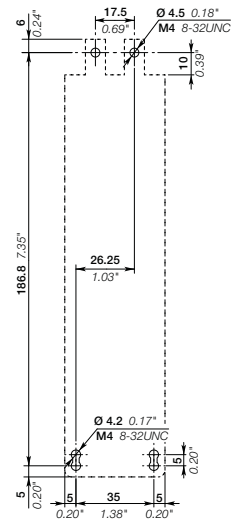

Note: contactor lateral distance to grounded component 2 mm 0.08" min.

DOL starters protected by M165 manual motor starters With AF contactors - open type version in kit form

Main dimensions mm, inches

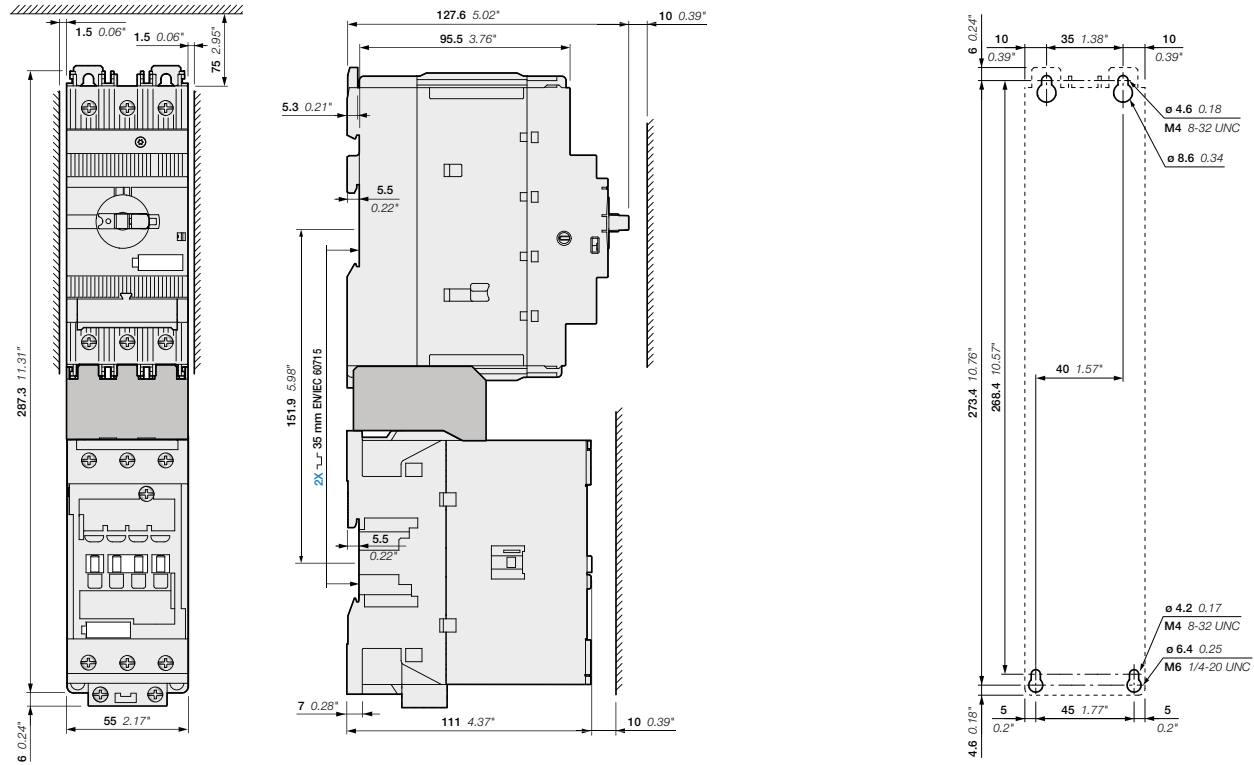

MS165
+ BEA65-4
+ AF40, AF52, AF65

Note: for $U_e > 400$ V, contactor lateral distance to grounded component 1.5 mm 0.06" min.

Reversing starters protected by M116 manual motor starters With AF contactors - open type version in kit form

Main dimensions mm, inches

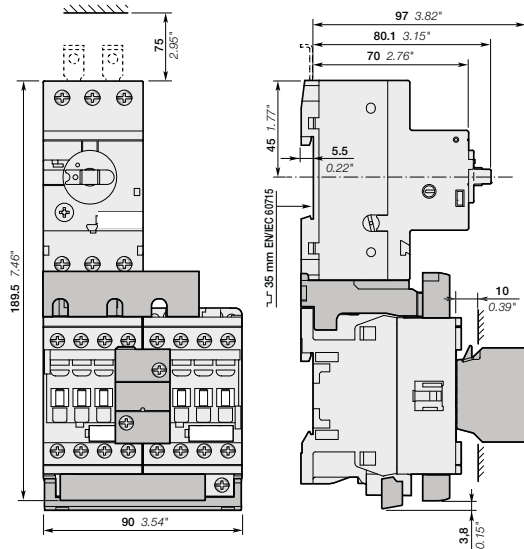

MS116-0.16 ... MS116-16
+ BEA16-4, BER16-4, VEM4
+ AF09, AF12, AF16

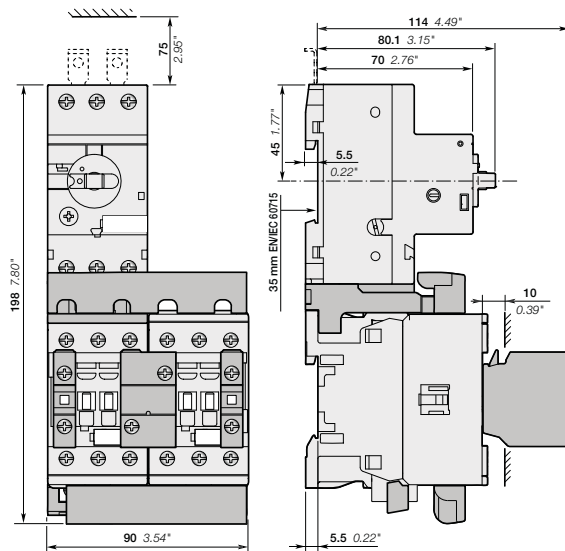

MS116-0.16 ... MS116-16
+ BEA26-4, BER38-4, VEM4, CA4-10
+ AF26, AF30, AF38

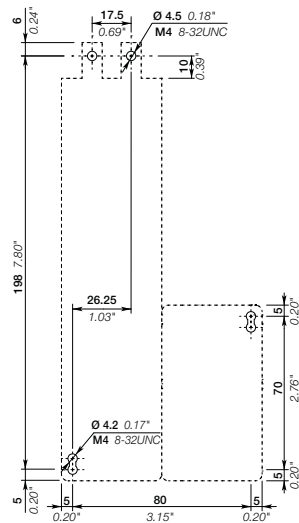

Note: contactor lateral distance to grounded component 2 mm 0.08" min.

Reversing starters protected by M132 manual motor starters With AF contactors - open type version in kit form

Main dimensions mm, inches

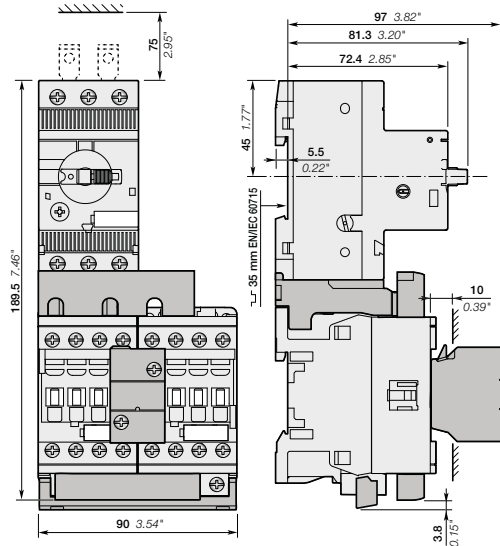

MS132-0.16 ... MS132-10
+ BEA16-4, BER16-4, VEM4
+ AF09, AF12, AF16

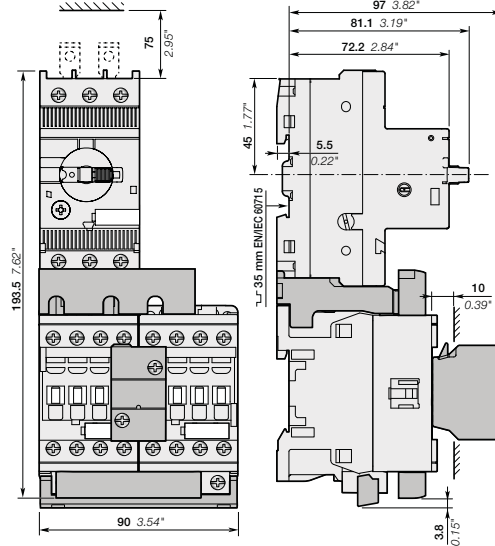

MS132-12 ... MS132-25
+ BEA16-4, BER16-4, VEM4
+ AF09, AF12, AF16

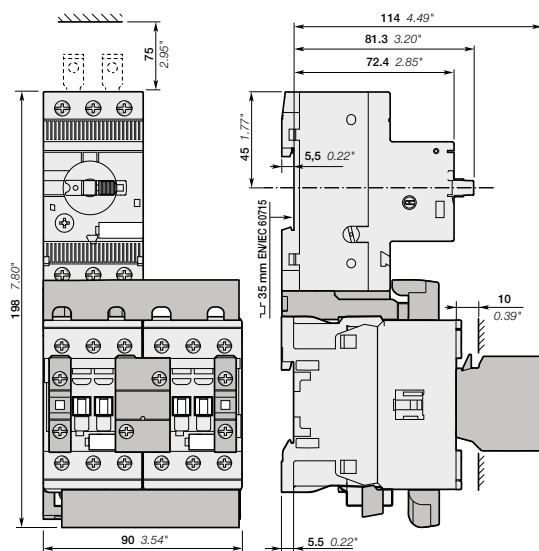

MS132-0.16 ... MS132-10
+ BEA26-4, BER38-4, VEM4, CA4-10
+ AF26, AF30, AF38

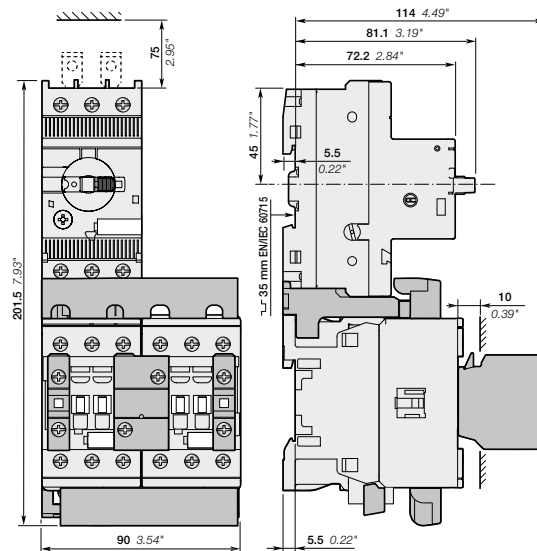

MS132-12 ... MS132-32
+ BEA38-4, BER38-4, VEM4, CA4-10
+ AF26, AF30, AF38

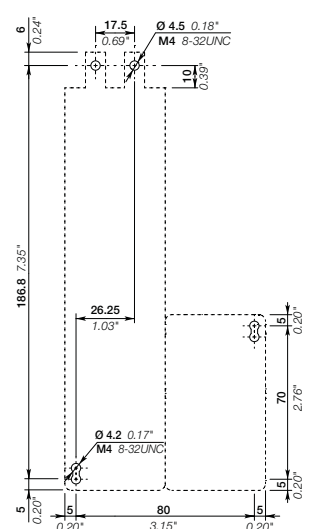

Note: contactor lateral distance to grounded component 2 mm 0.08" min.

Reversing starters protected by M165 manual motor starters With AF contactors - open type version in kit form

Main dimensions mm, inches

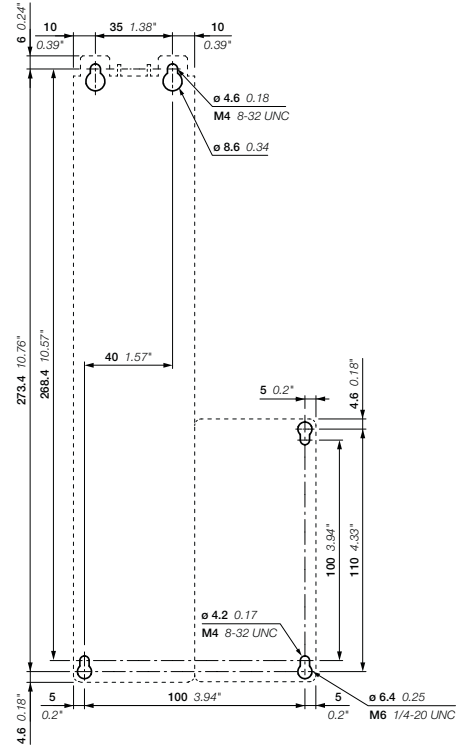
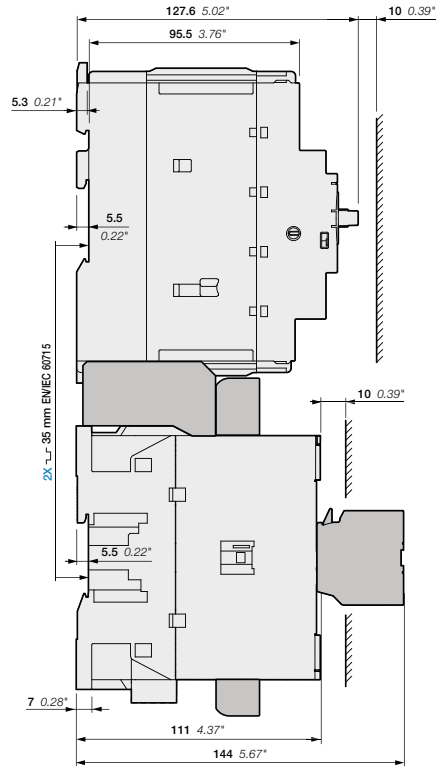
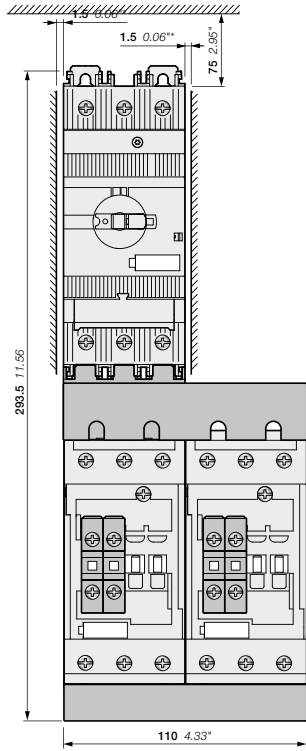

MS165
+ BEA65-4, BER65-4, VM96-4
+ AF40, AF52, AF65

Note: for $U_e > 400$ V, contactor lateral distance to grounded component 1.5 mm 0.06" min.

Notes

A series of horizontal dotted lines for writing notes.

DOL starters protected by moulded-case circuit-breakers and overload relays

With AF contactors - Open type version in kit form

5



XT2S 160 + BEA140/XT2 + AF140-30-11

Application

Full voltage direct-on-line (DOL) starting for controlling three-phase asynchronous motors is a simple and economic solution characterised by a high starting torque (1.9 to 2.1 times full-speed torque) and a starting current 5.5 to 7 times nominal current.

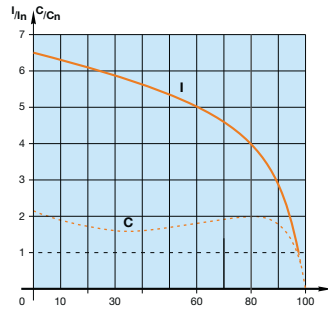

I = current
C = torque
In = nominal current
Cn = nominal torque

Coordination types

The contactor and the moulded-case circuit-breaker control and protect motors against overload and short-circuits according to coordination types 1 and 2 (IEC 60947-4-1/EN 60947-4-1) defining the anticipated level of service continuity as follows:

Type 1: In short-circuit conditions, the contactor or starter does not endanger persons or installations and will not be able to then operate without being repaired or having parts replaced.

Type 2: In short-circuit conditions, the contactor or starter does not endanger persons or installations and will be able to operate afterwards. The risk of contacts light welding is acceptable.

Main Technical Data

Standards	IEC 60947-4-1 / EN 60947-4-1
Rated operational voltage U_e max.	400 V - 50/60 Hz
Rated insulation voltage U_i	
acc. to IEC 60947-4-1	690 V
acc. to UL / CSA	600 V
Switching frequency	≤ 15 starts/hour - 80 % max. load factor - with max. 1.5 s starting time ≤ 30 starts/hour - 50 % max. load factor - with max. 1.5 s starting time
Ambient air temperature	
Close to the device	< 55 °C
Degree of protection	IP20



XT2S 160 + BEA140/XT2 + AF140-30-11 + EF146

Mounting positions

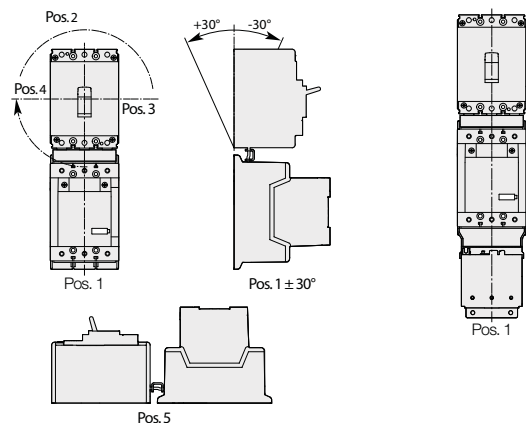

Direct-on-line
MCCB + AF

Direct-on-line
MCCB + AF + OL

DOL starters protected by moulded-case circuit-breakers and overload relays

With AF contactors - Open type version in kit form

Description

You can easily assemble a direct-on-line starter by using the BEA connection bars. It is used to electrically connect MCCB moulded-case circuit-breaker and AF116 ... AF370 contactor, AC or DC operated.

Select now easily and quickly your starter in the following pages for coordination type 1 or 2 at 400 V, 50/60 Hz, I_q = 50 kA up to 200 kW.

For the full coordination tables: www.abb.com/lowvoltage then go to the right menu: "Support", select: "Online Product Selection Tools" then select "Coordination Tables for motor protection"

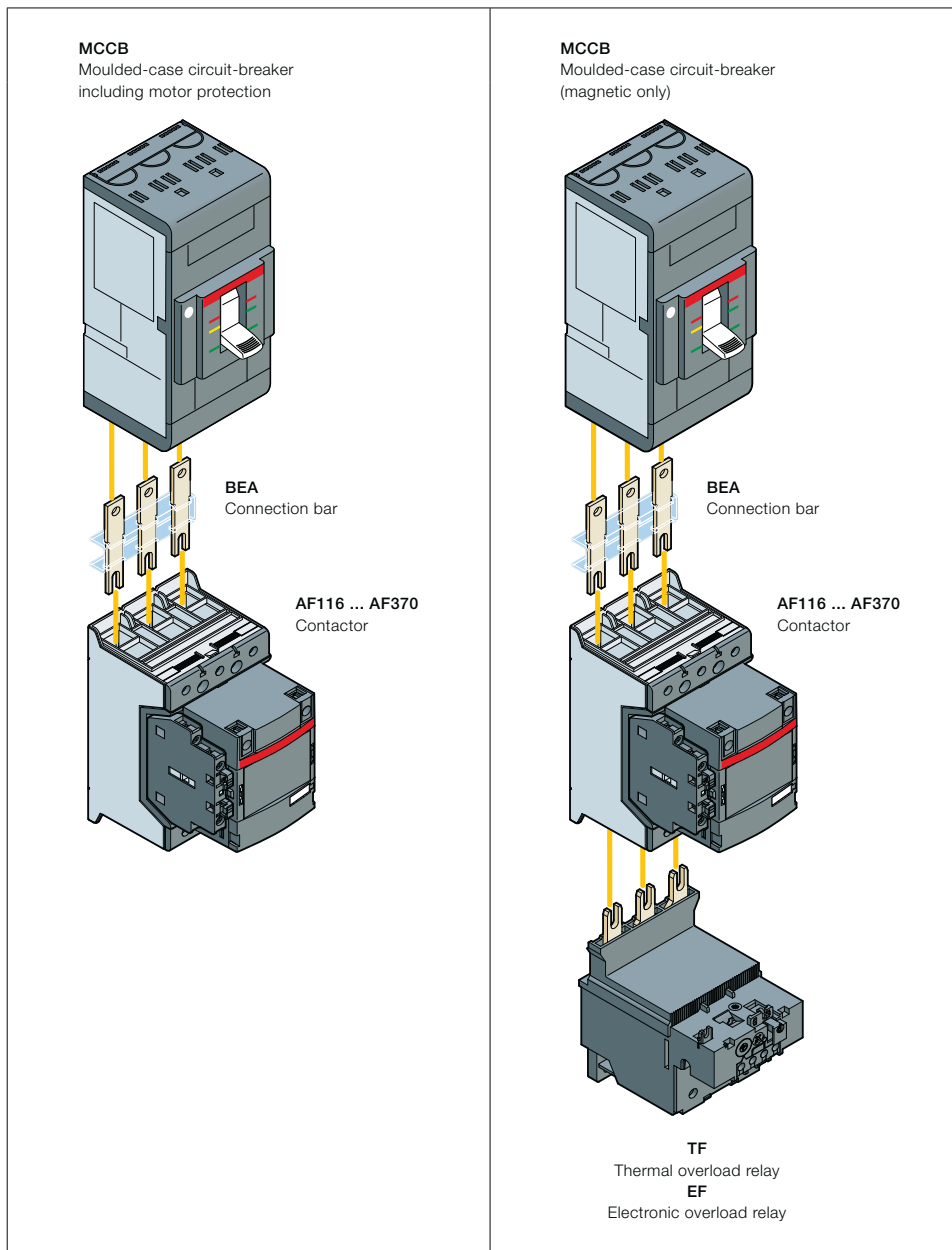

DOL starters protected by MCCB including motor protection Coordination type 1 or 2

Coordination type 1 or 2, AC-3, 50 kA, 400 V, 50/60 Hz

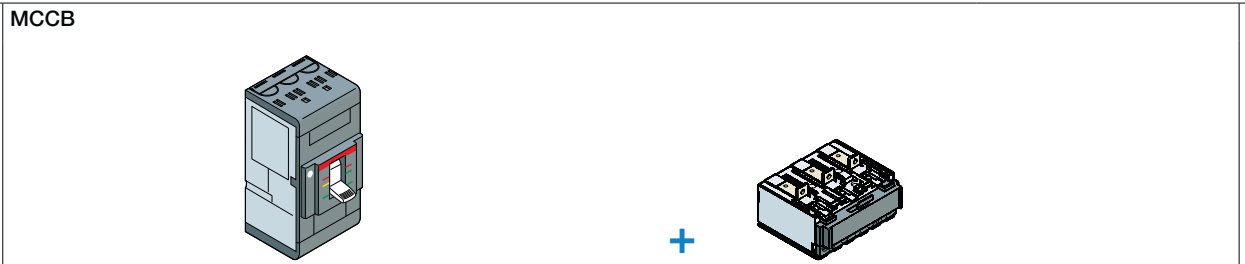

IEC AC-3, 400 V Rated power kW		Rated current A	Magnetic tripping current setting A	Max. allowed thermal setting	Base Type	Order code		Trip unit Type	Order code
55	97	1440	116	116	XT2S 160	1SDA068164R1		+ Ekip M-LIU In160	1SDA067355R1
75	132	1920	140	140	XT2S 160	1SDA068164R1		+ Ekip M-LIU In160	1SDA067355R1
90	160	2400	190	190	T4S 250 PR222MP In200	1SDA054527R1		Included	-
110	195	2880	205	205	T5S 400 PR222MP In320	1SDA054553R1		Included	-
132	230	3600	265	265	T5S 400 PR222MP In400	1SDA054554R1		Included	-
160	280	4400	305	305	T5S 400 PR222MP In400	1SDA054554R1		Included	-

5

Contactors

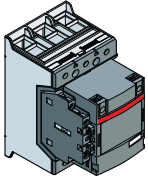

Connection bars

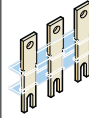

Control voltage
Uc min. ... Uc max.

Type

Order code

Type

Order code

V 50/60 Hz

V DC

V 50/60 Hz	V DC	Type	Order code	Type	Order code
24...60	20...60	AF116-30-11-11	1SFL427001R1111	BEA140/XT2	1SFN084206R1000
100...250	100...250	AF116-30-11-13	1SFL427001R1311		
24...60	20...60	AF140-30-11-11	1SFL447001R1111	BEA205/T4	1SFN084806R1001
100...250	100...250	AF140-30-11-13	1SFL447001R1311		
24...60	20...60	AF190-30-11-11	1SFL487002R1111	BEA205/T4	1SFN084806R1001
100...250	100...250	AF190-30-11-13	1SFL487002R1311		
24...60	20...60	AF205-30-11-11	1SFL527002R1111	BEA370/T5	1SFN085406R1000
100...250	100...250	AF205-30-11-13	1SFL527002R1311		
24...60	20...60	AF265-30-11-11	1SFL547002R1111	BEA370/T5	1SFN085406R1000
100...250	100...250	AF265-30-11-13	1SFL547002R1311		
24...60	20...60	AF305-30-11-11	1SFL587002R1111	BEA370/T5	1SFN085406R1000
100...250	100...250	AF305-30-11-13	1SFL587002R1311		

DOL starters protected by MCCB (magnetic only) and overload relays

Coordination type 1 or 2

Coordination type 1 or 2, AC-3, 50 kA, 400 V, 50/60 Hz

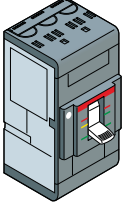
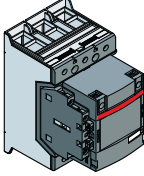
MCCB 	Contactors 
--	--

Thermal overload relays

IEC AC-3, 400 V Rated power kW	Rated current A	Magnetic tripping current A	Type	Order code	Control voltage Uc min. ... Uc max.		Type	Order code
					V 50/60 Hz	V DC		
55	97	1600	XT2S 160 MA 160	1SDA076530R1	24...60	20...60	AF116-30-11-11	1SFL427001R1111
					100...250	100...250	AF116-30-11-13	1SFL427001R1311
75	132	1920	XT2S 160 MA 160	1SDA076530R1	24...60	20...60	AF140-30-11-11	1SFL447001R1111
					100...250	100...250	AF140-30-11-13	1SFL447001R1311
90	160	2250	XT4S 250 Ekip I In250	1SDA068480R1	24...60	20...60	AF190-30-11-11	1SFL487002R1111
					100...250	100...250	AF190-30-11-13	1SFL487002R1311
110	195	2720	T4S 320 PR221-I In320	1SDA054126R1	24...60	20...60	AF205-30-11-11	1SFL527002R1111
					100...250	100...250	AF205-30-11-13	1SFL527002R1311

Electronic overload relays

55	97	1600	XT2S 160 MA 160	1SDA076530R1	24...60	20...60	AF116-30-11-11	1SFL427001R1111
					100...250	100...250	AF116-30-11-13	1SFL427001R1311
75	132	1920	XT2S 160 MA 160	1SDA076530R1	24...60	20...60	AF140-30-11-11	1SFL447001R1111
					100...250	100...250	AF140-30-11-13	1SFL447001R1311
90	160	2250	XT4S 250 Ekip I In250	1SDA068480R1	24...60	20...60	AF190-30-11-11	1SFL487002R1111
					100...250	100...250	AF190-30-11-13	1SFL487002R1311
110	195	2720	T4S 320 PR221-I In320	1SDA054126R1	24...60	20...60	AF205-30-11-11	1SFL527002R1111
					100...250	100...250	AF205-30-11-13	1SFL527002R1311
132	230	3200	T5S 400 PR221-I In400	1SDA054335R1	24...60	20...60	AF265-30-11-11	1SFL547002R1111
					100...250	100...250	AF265-30-11-13	1SFL547002R1311
160	280	4000	T5S 400 PR221-I In400	1SDA054335R1	24...60	20...60	AF305-30-11-11	1SFL587002R1111
					100...250	100...250	AF305-30-11-13	1SFL587002R1311
200	350	5040	T5S 630 PR221-I In630	1SDA054405R1	24...60	20...60	AF370-30-11-11	1SFL607002R1111
					100...250	100...250	AF370-30-11-13	1SFL607002R1311

Overload relays

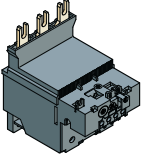

Connection bars

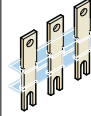

Setting ranges	Max. allowed setting current	Type	Order code	Type	Order code
A	A				
80...110	110	TF140DU-110	1SAZ431201R1002	BEA140/XT2	1SFN084206R1000
110...142	140	TF140DU-142	1SAZ431201R1004		
130...175	175	TA200DU-175	1SAZ421201R1005	BEA205/XT4	1SFN084806R1000
155...200	200	TA200DU-200	1SAZ421201R1006	BEA205/T4	1SFN084806R1001
54...150	116	EF146-150	1SAX351001R1101	BEA140/XT2	1SFN084206R1000
54...150	140	EF146-150	1SAX351001R1101		
63...210	190	EF205-210	1SAX531001R1101	BEA205/XT4	1SFN084806R1000
63...210	205	EF205-210	1SAX531001R1101	BEA205/T4	1SFN084806R1001
115...380	265	EF370-380	1SAX611001R1101	BEA370/T5	1SFN085406R1000
115...380	305	EF370-380	1SAX611001R1101		
115...380	350	EF370-380	1SAX611001R1101		

DOL starters protected by moulded-case circuit-breakers and overload relays

With AF contactors - Open type version in kit form

Direct-on-line starters

Protected by MCCB including motor protection

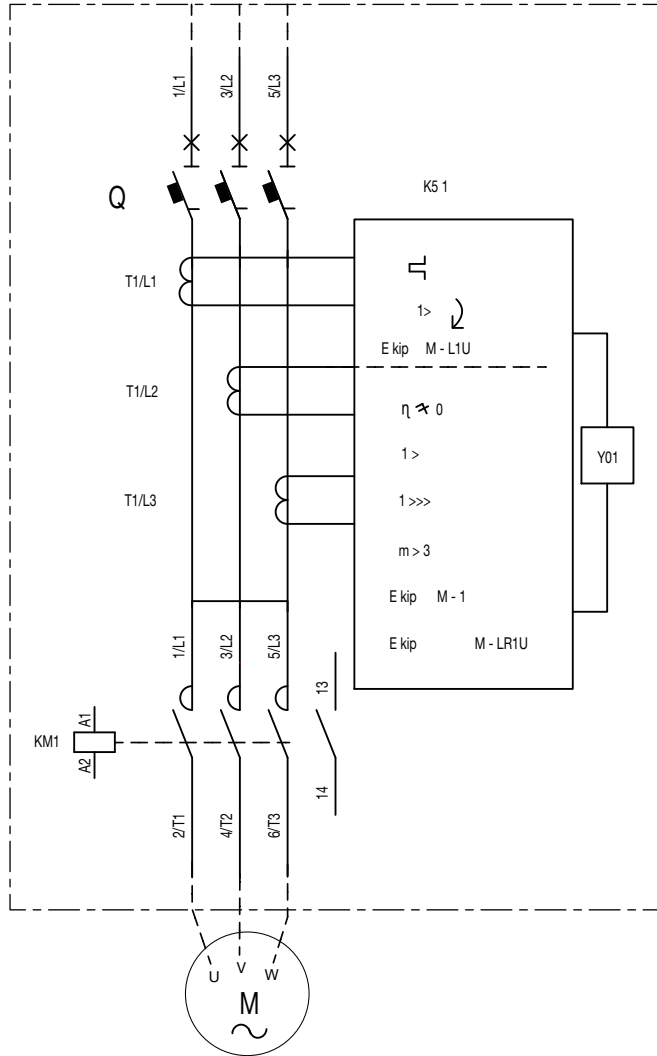

Protected by MCCB (magnetic only) and overload relays

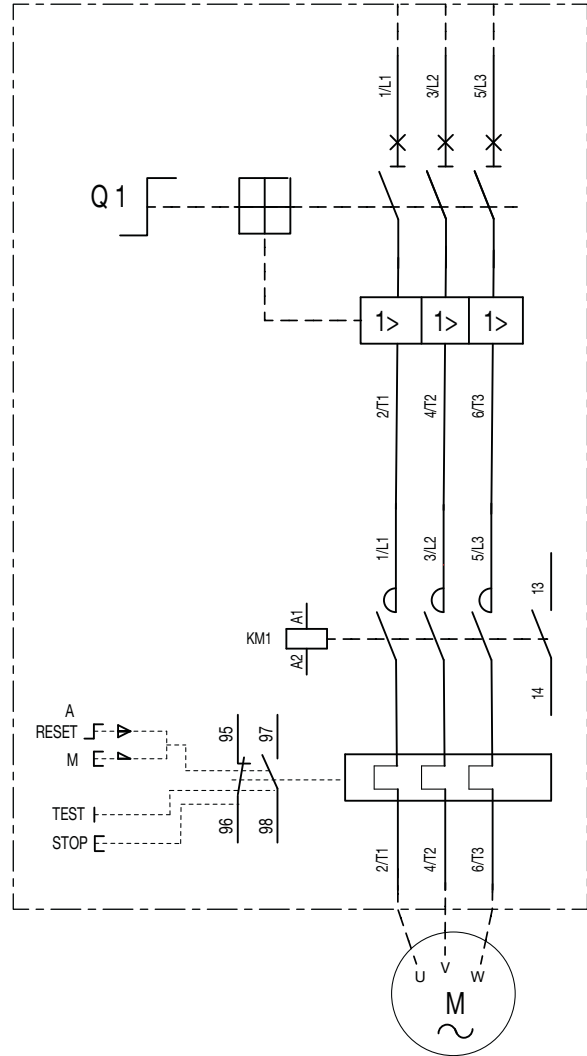

DOL starters protected by MCCB, including motor protection With AF contactors - Open type version in kit form

Main dimensions mm, inches

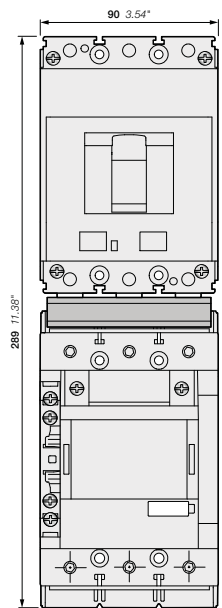

**XT2S 160 + Ekip M-LIU In160
+ BEA140/XT2
+ AF116, AF140, AF146**

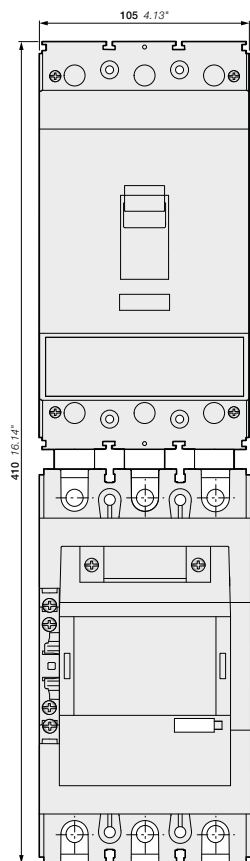
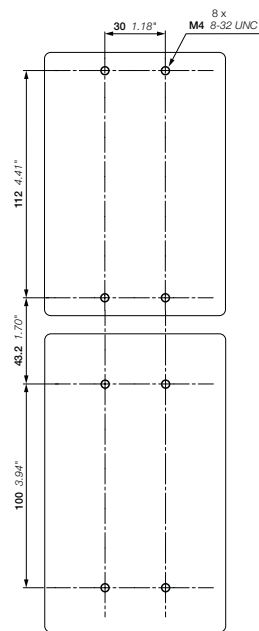
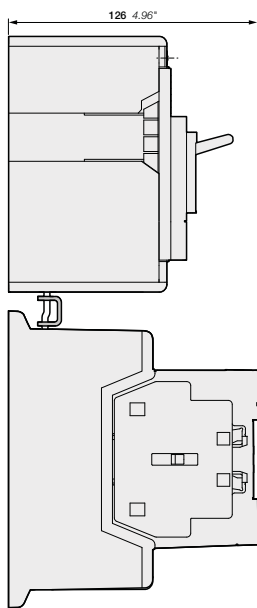

**T4S
+ BEA205/T4
+ AF190, AF205**

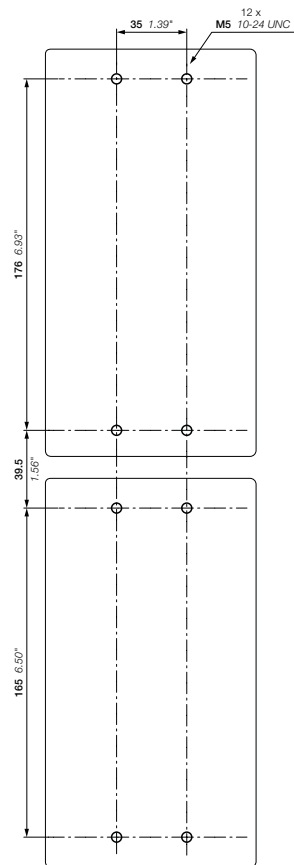
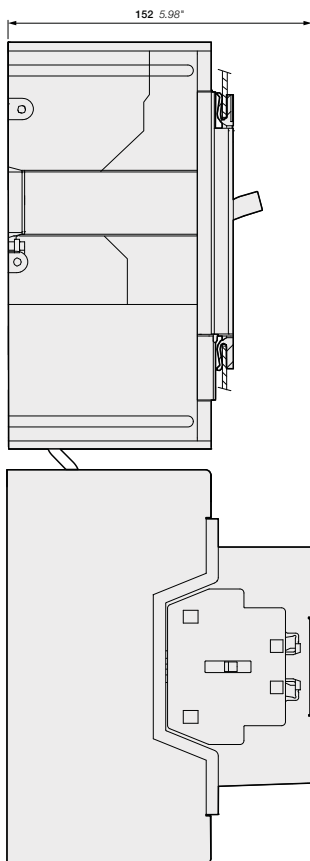

DOL starters protected by MCCB, including motor protection With AF contactors - Open type version in kit form

Main dimensions mm, inches

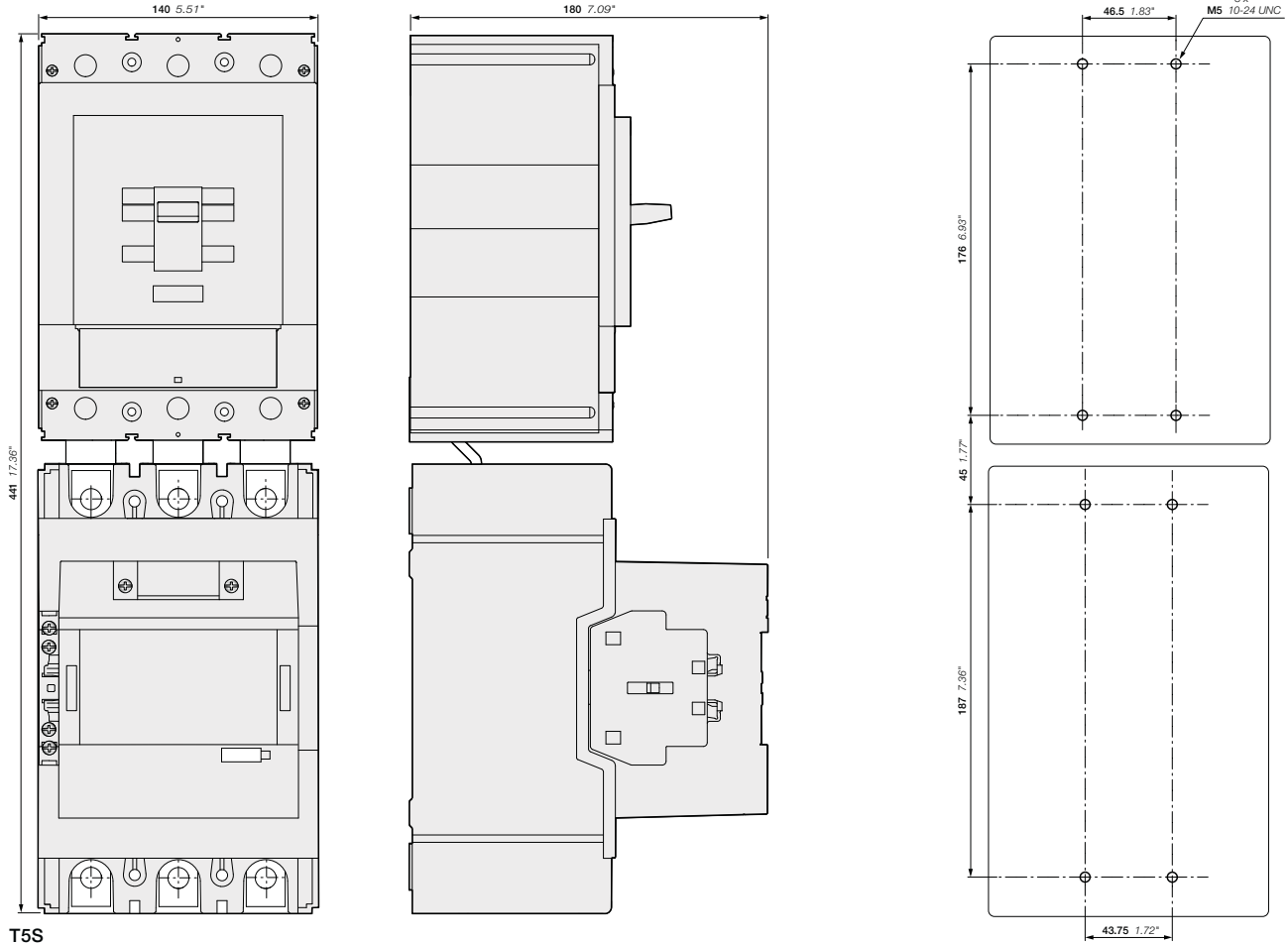

- T5S
- + BEA370/T5
- + AF265, AF305, AF370

DOL starters protected by MCCB (magnetic only) and thermal overload relays

With AF contactors - Open type version in kit form

Main dimensions mm, inches

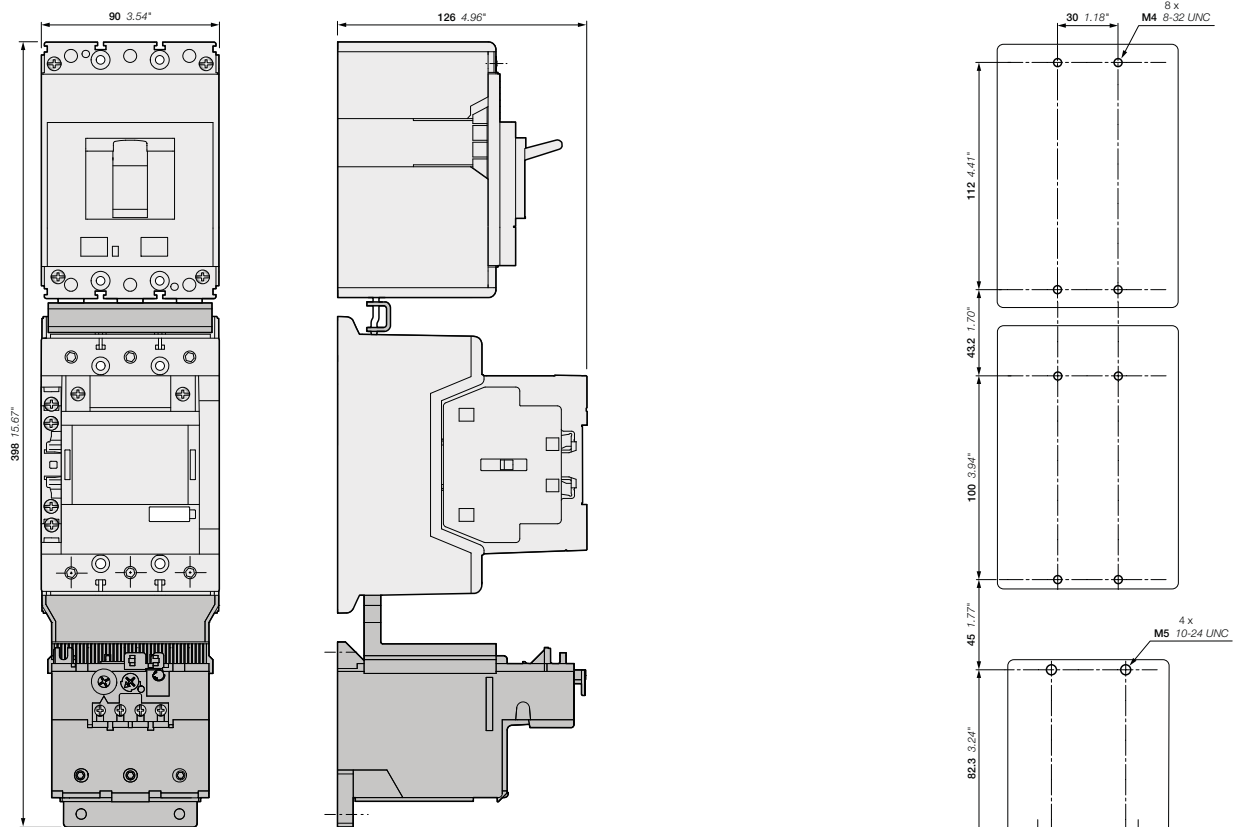

- XT2S
- + BEA140/XT2
- + AF116, AF140, AF146
- + TF140 thermal overload relay

DOL starters protected by MCCB (magnetic only) and thermal overload relays

With AF contactors - Open type version in kit form

Main dimensions mm, inches

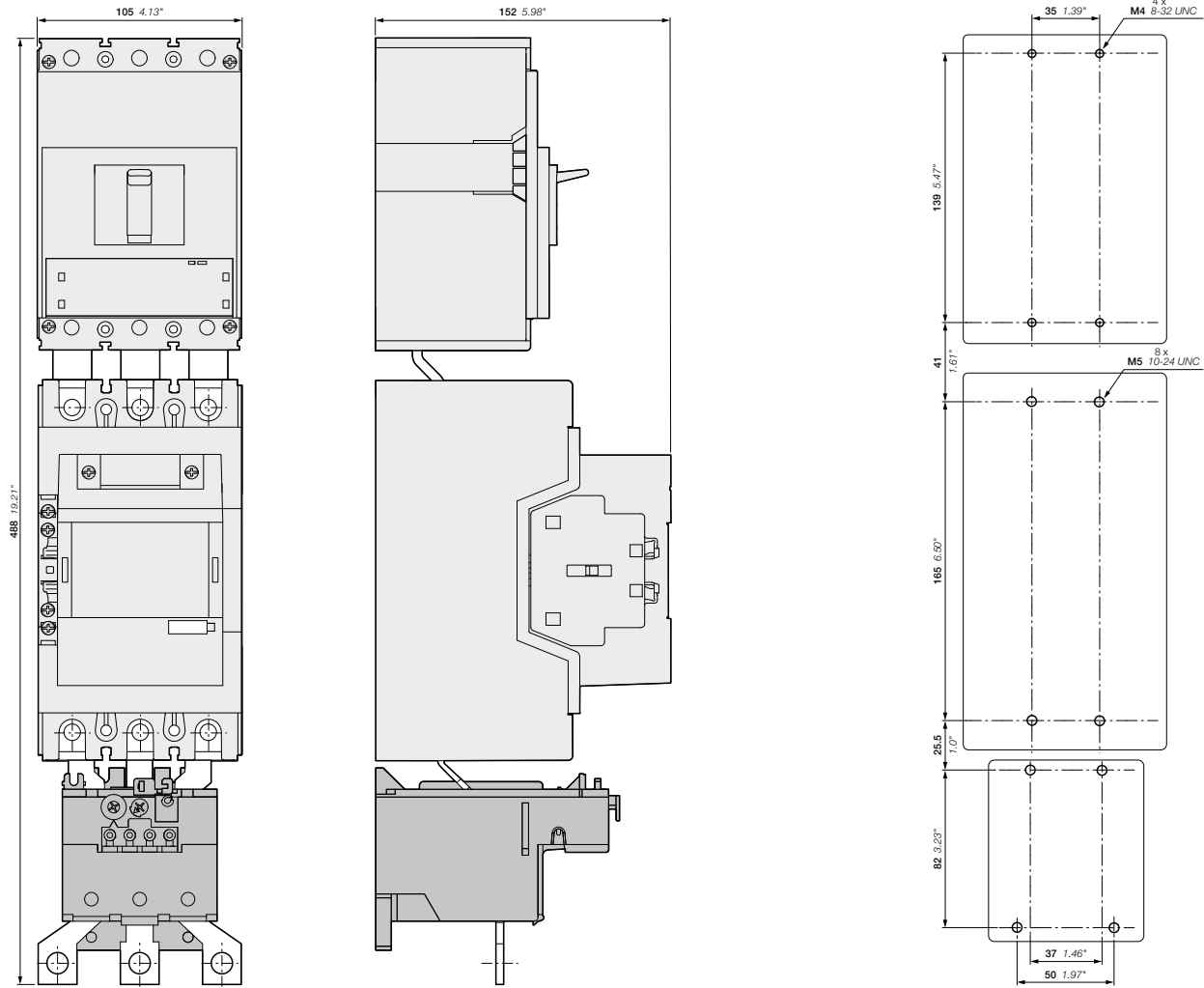

- XT4S**
 + BEA205/XT4
 + AF190, AF205
 + TA200DU thermal overload relay

DOL starters protected by MCCB (magnetic only) and thermal overload relays

With AF contactors - Open type version in kit form

Main dimensions mm, inches

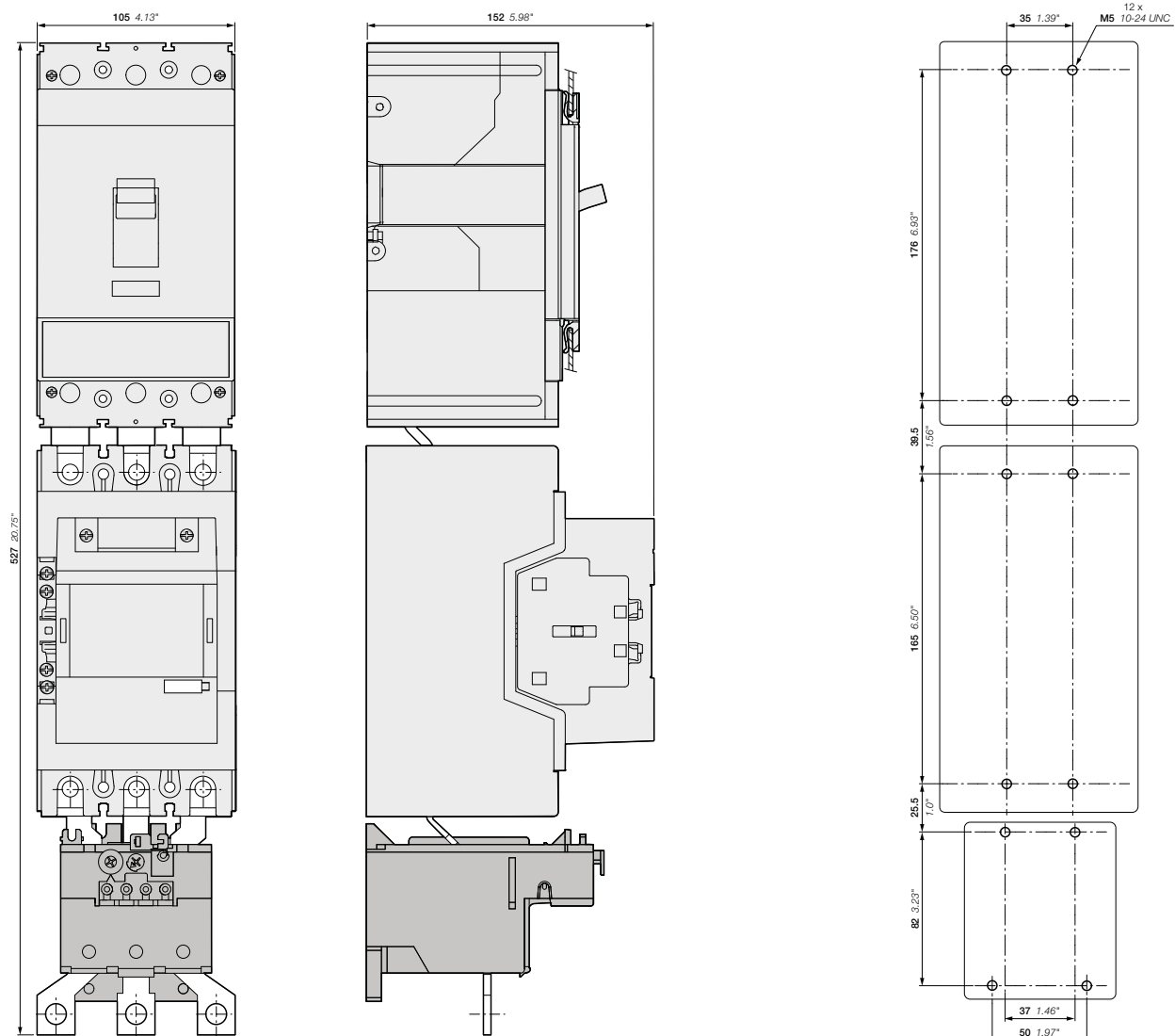

- T4S
- + BEA205/T4
- + AF190, AF205
- + TA200DU thermal overload relay

DOL starters protected by MCCB (magnetic only) and electronic overload relays

With AF contactors - Open type version in kit form

Main dimensions mm, inches

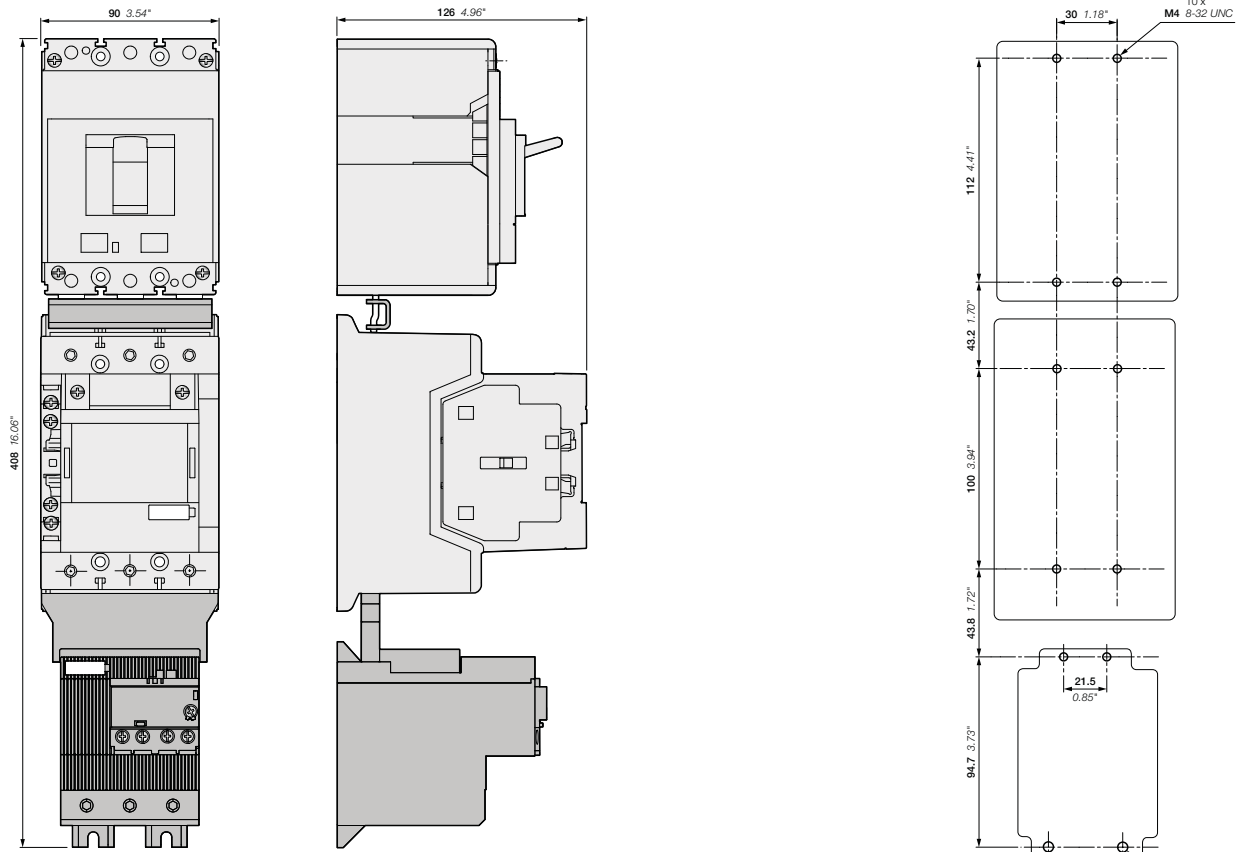

5

- XT2S
- + BEA140/XT2
- + AF116, AF140, AF146
- + EF146 electronic overload relay

DOL starters protected by MCCB (magnetic only) and electronic overload relays With AF contactors - Open type version in kit form

Main dimensions mm, inches

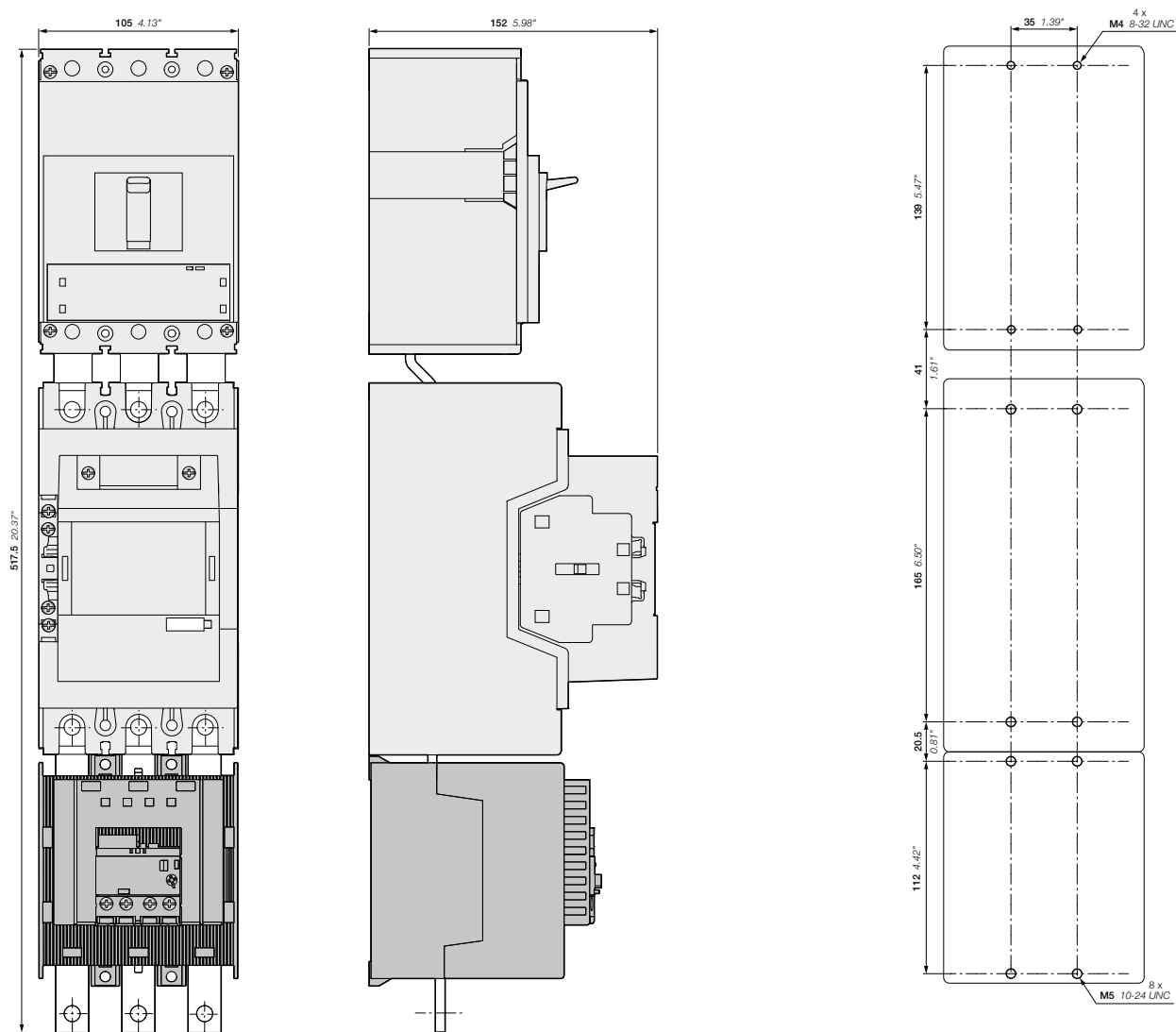

- XT4S
- + BEA205/XT4
- + AF190, AF205
- + EF205 electronic overload relay

DOL starters protected by MCCB (magnetic only) and electronic overload relays

With AF contactors - Open type version in kit form

Main dimensions mm, inches

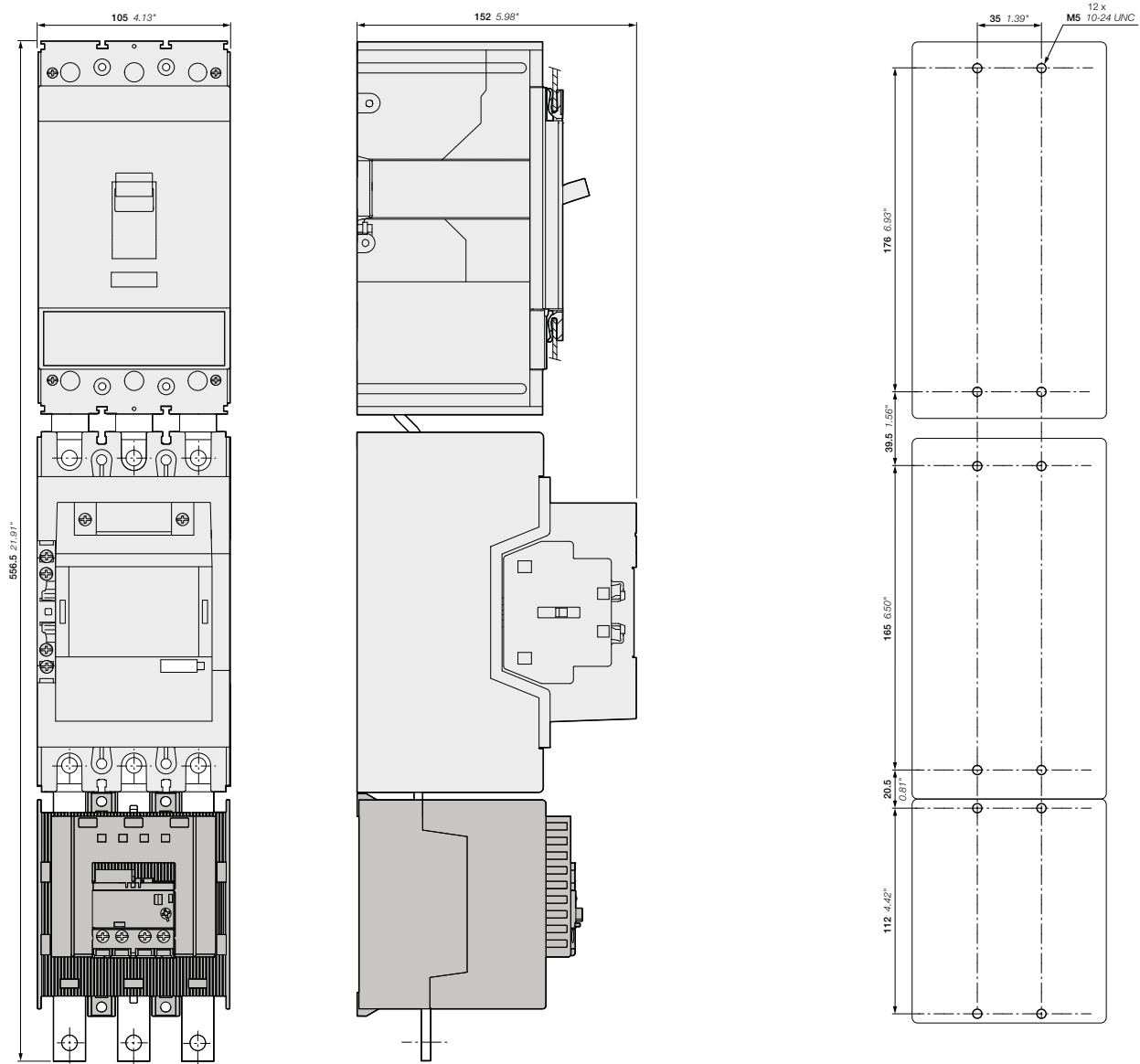

- T4S
 + BEA205/T4
 + AF190, AF205
 + EF205 electronic overload relay

DOL starters protected by MCCB (magnetic only) and electronic overload relays

With AF contactors - Open type version in kit form

Main dimensions mm, inches

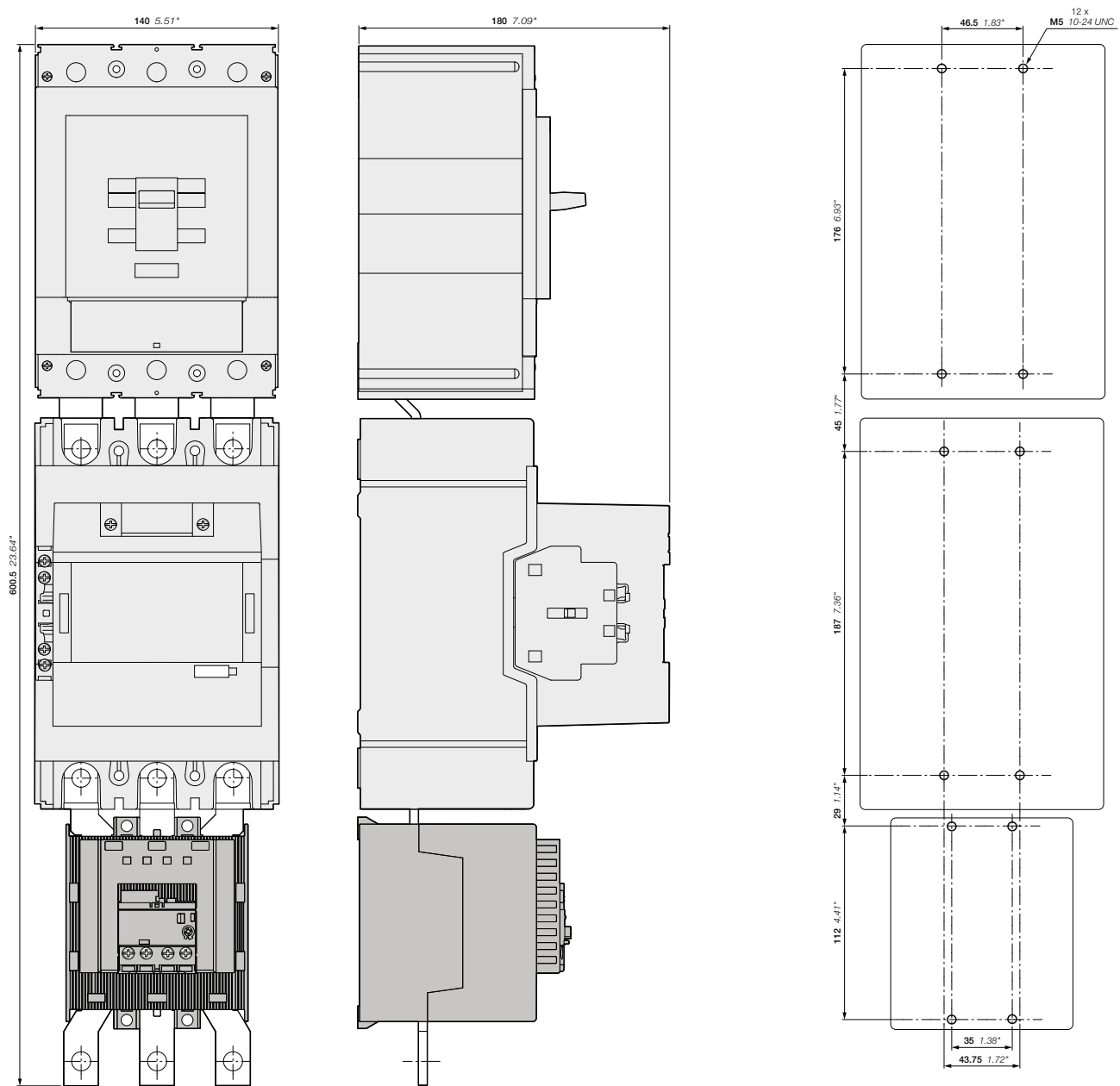

- T5S
 + BEA370/T5
 + AF265, AF305, AF370
 + EF370 electronic overload relay

DOL and reversing starters protected by overload relays With AF contactors - Open type version in kit form

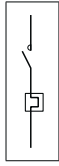

Application

Full voltage direct-on-line and reversing starting for controlling three-phase asynchronous motors is a simple and economic solution characterised by a high starting torque (1.9 to 2.1 times full-speed torque) and a starting current 5.5 to 7 times nominal current.

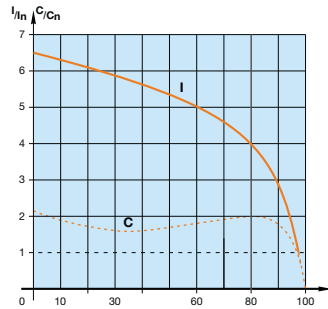

Coordination Types

The contactor, the short-circuit protection device and the thermal overload relay control and protect motors against overload and short-circuits according to coordination types 1 and 2 (IEC 60947-4-1 / EN 60947-4-1) defining the anticipated level of service continuity as follow:

Type 1: In short-circuit conditions, the contactor or starter does not endanger persons or installations and will not be able to then operate without being repaired or having parts replaced.

Type 2: In short-circuit conditions, the contactor or starter does not endanger persons or installations and will be able to operate afterwards. The risk of contacts light welding is acceptable.

Main Technical Data

Standards	IEC 60947-4-1 / EN 60947-4-1
Rated operational voltage U_e max.	690 V - 50/60 Hz
Rated insulation voltage U_i	
acc. to IEC 60947-4-1	690 V
acc. to UL / CSA	600 V
Ambient air temperature	
Close to the device	≤ 60 °C (TF42: 38 A above ≤ 50 °C)
Degree of protection	IP20
Switching frequency	Refer to "Switching frequency diagrams" page



Mounting positions



Direct-on-line

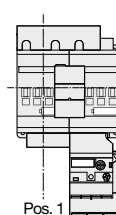

Reversing

DOL and reversing starters protected by overload relays

With AF contactors - Open type version in kit form

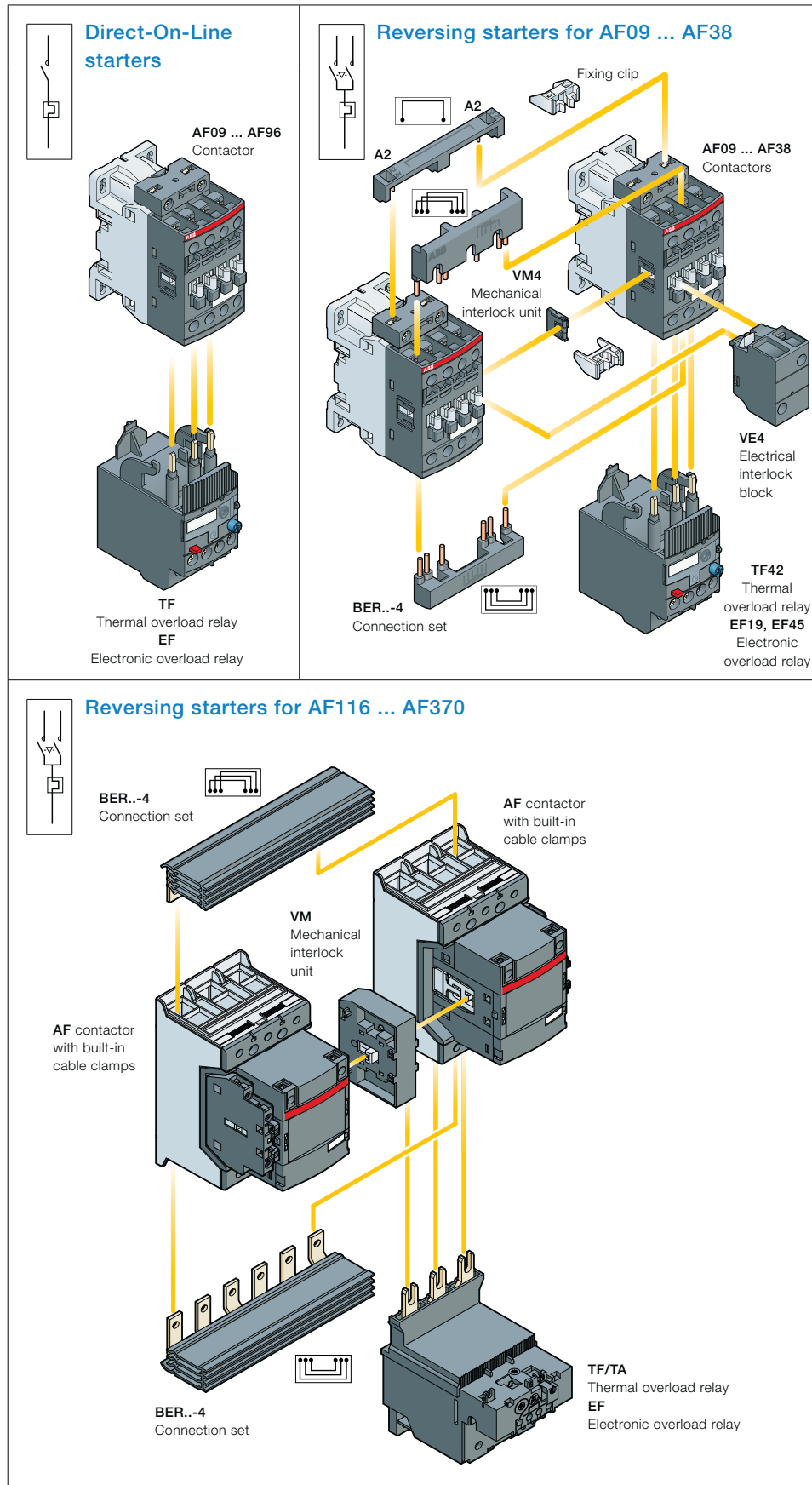

Description

You can easily assemble a direct-on-line starter by connecting AF contactor and TF thermal overload relay or EF electronic overload relay.

You can also easily assemble reversing starter thanks to our complete range of accessories:

- For AF09 ... AF38, use VEM4 mechanical and electrical interlock set for reversing starter in 90 mm width. It includes:
 - VM4 mechanical interlock unit including 2 fixing clips
 - VE4 electrical interlock block with A2-A2 connection.
- For AF40 ... AF370, use VM mechanical interlock unit and additional auxiliary contact blocks for electrical interlocking.
- BER...-4 connection set: it assures a safe and simple reversing connection between both contactor main terminals.

Select now easily and quickly your starter in the following pages at 400 V, up to 200 kW.

For the full coordination tables: www.abb.com/lowvoltage then go to the right menu: "Support", select: "Online Product Selection Tools" then select "Coordination Tables for motor protection"

Direct-on-line starters protected by thermal overload relays

With AF contactors - Open type version in kit form

IEC		Control voltage Uc min. ... Uc max. (1)				Type	Order code	Setting ranges	Type	Order code
Rated power	Rated current	V 50/60 Hz		V DC				A		
4	8.5	24...60	20...60	100...250	100...250	AF09Z-30-10-21	1SBL136001R2110	7.60...10.0	TF42-10	1SAZ721201R1043
						AF09-30-10-13	1SBL137001R1310			
5.5	11.5	24...60	20...60	100...250	100...250	AF12Z-30-10-21	1SBL156001R2110	10.0...13.0	TF42-13	1SAZ721201R1045
						AF12-30-10-13	1SBL157001R1310			
7.5	15.5	24...60	20...60	100...250	100...250	AF16Z-30-10-21	1SBL176001R2110	13.0...16.0	TF42-16	1SAZ721201R1047
						AF16-30-10-13	1SBL177001R1310			
11	22	24...60	20...60	100...250	100...250	AF26Z-30-00-21	1SBL236001R2100	20.0...24.0	TF42-24	1SAZ721201R1051
						AF26-30-00-13	1SBL237001R1300			
15	29	24...60	20...60	100...250	100...250	AF30Z-30-00-21	1SBL276001R2100	29.0...35.0	TF42-35	1SAZ721201R1053
						AF30-30-00-13	1SBL277001R1300			
18.5	35	24...60	20...60	100...250	100...250	AF38Z-30-00-21	1SBL296001R2100	35.0...38.0/40.0	TF42-38	1SAZ721201R1055
						AF38-30-00-13	1SBL297001R1300			
18.5	35	24...60	20...60	100...250	100...250	AF40-30-00-11	1SBL347001R1100	30.0...40.0	TF65-40	1SAZ811201R1003
						AF40-30-00-13	1SBL347001R1300			
22	41	24...60	20...60	100-250	100-250	AF52-30-00-11	1SBL367001R1100	36.00...47.0	TF65-47	1SAZ811201R1004
						AF52-30-00-13	1SBL367001R1300			
30	55	24...60	20...60	100-250	100-250	AF65-30-00-11	1SBL387001R1100	50.0...60.0	TF65-60	1SAZ811201R1006
						AF65-30-00-13	1SBL387001R1300			
37	66	24...60	20...60	100-250	100-250	AF80-30-00-11	1SBL397001R1100	57.0...68.0	TF96-68	1SAZ911201R1003
						AF80-30-00-13	1SBL397001R1300			
45	80	24...60	20...60	100-250	100-250	AF96-30-00-11	1SBL407001R1100	75.0...87.0	TF96-87	1SAZ911201R1005
						AF96-30-00-13	1SBL407001R1300			
55	97	24...60	20...60	100-250	100-250	AF116-30-11-11	1SFL427001R1111	80...110	TF140DU-110	1SAZ431201R1002
						AF116-30-11-13	1SFL427001R1311			
75	132	24...60	20...60	100-250	100-250	AF140-30-11-11	1SFL447001R1111	100...135	TF140DU-135	1SAZ431201R1003
						AF140-30-11-13	1SFL447001R1311			
90	160	24...60	20...60	100-250	100-250	AF190-30-11-11	1SFL487002R1111	130...175	TA200DU-175	1SAZ421201R1005
						AF190-30-11-13	1SFL487002R1311			
110	195	24...60	20...60	100-250	100-250	AF205-30-11-11	1SFL527002R1111	150...200	TA200DU-200	1SAZ421201R1006
						AF205-30-11-13	1SFL527002R1311			

(1) For other control voltages, see "Voltage code table".

Note : for rated power above 110 kW, refer to "Starters protected by electronic overload relays".

Reversing starters protected by thermal overload relays

With AF contactors - Open type version in kit form

IEC		Control voltage				Type	Order code	Thermal overload relays			Accessories	
AC-3, 400 V	Rated power kW	Rated current A	Uc min. ... Uc max. (1)		Type	Order code	Setting ranges A	Type	Order code	Type	Order code	
			V 50/60 Hz	V DC						Type	Order code	
4	8.5	8.5	24...60	20...60	AF09Z-30-10-21	1SBL136001R2110	7.6...10.0	TF42-10	1SAZ721201R1043	+	BER16-4 VEM4	1SBN081311R1000 1SBN030111R1000
			100...250	100...250	AF09-30-10-13	1SBL137001R1310						
5.5	11.5	11.5	24...60	20...60	AF12Z-30-10-21	1SBL156001R2110	10.0...13.0	TF42-13	1SAZ721201R1045			
			100...250	100...250	AF12-30-10-13	1SBL157001R1310						
7.5	15.5	15.5	24...60	20...60	AF16Z-30-10-21	1SBL176001R2110	13.0...16.0	TF42-16	1SAZ721201R1047			
			100...250	100...250	AF16-30-10-13	1SBL177001R1310						
11	22	22	24...60	20...60	AF26Z-30-00-21	1SBL236001R2100	20.0...24.0	TF42-24	1SAZ721201R1051	+	BER38-4 VEM4	1SBN082311R1000 1SBN030111R1000
			100...250	100...250	AF26-30-00-13	1SBL237001R1300						
15	29	29	24...60	20...60	AF30Z-30-00-21	1SBL276001R2100	29.0...35.0	TF42-35	1SAZ721201R1053	+ 2x	CA4-10	1SBN010110R1010
			100...250	100...250	AF30-30-00-13	1SBL277001R1300						
18.5	35	35	24...60	20...60	AF38Z-30-00-21	1SBL296001R2100	35.0...38.0/40.0	TF42-38	1SAZ721201R1055			
			100...250	100...250	AF38-30-00-13	1SBL297001R1300						
18.5	35	35	24...60	20...60	AF40-30-00-11	1SBL347001R1100	30.0...40.0	TF65-40	1SAZ811201R1003	+	BER65-4 VM96-4	1SBN083411R1000 1SBN033405T1000
			100...250	100...250	AF40-30-00-13	1SBL347001R1300						
22	41	41	24...60	20...60	AF52-30-00-11	1SBL367001R1100	36.0...47.0	TF65-47	1SAZ811201R1004	+ 2x	CA4-10	1SBN010110R1010
			100...250	100...250	AF52-30-00-13	1SBL367001R1300						
30	55	55	24...60	20...60	AF65-30-00-11	1SBL387001R1100	50.0...60.0	TF65-60	1SAZ811201R1006	+ 2x	CA4-01	1SBN010110R1001
			100...250	100...250	AF65-30-00-13	1SBL387001R1300						
37	66	66	24...60	20...60	AF80-30-00-11	1SBL397001R1100	57.0...68.0	TF96-68	1SAZ911201R1003	+	BER96-4 VM96-4	1SBN083911R1000 1SBN033405T1000
			100...250	100...250	AF80-30-00-13	1SBL397001R1300						
45	80	80	24...60	20...60	AF96-30-00-11	1SBL407001R1100	75.0...87.0	TF96-87	1SAZ911201R1005	+ 2x	CA4-10	1SBN010110R1010
			100...250	100...250	AF96-30-00-13	1SBL407001R1300						
55	97	97	24...60	20...60	AF116-30-11-11	1SFL427001R1111	80...110	TF140DU-110	1SAZ431201R1002	+	BER140-4 VM19	1SFN084211R1000 1SFN030300R1000
			100...250	100...250	AF116-30-11-13	1SFL427001R1311						
75	132	132	24...60	20...60	AF140-30-11-11	1SFL447001R1111	100...135	TF140DU-135	1SAZ431201R1003			
			100...250	100...250	AF140-30-11-13	1SFL447001R1311						
90	160	160	24...60	20...60	AF190-30-11-11	1SFL487002R1111	130...175	TA200DU-175	1SAZ421201R1005	+	BER205-4 VM19	1SFN084811R1000 1SFN030300R1000
			100...250	100...250	AF190-30-11-13	1SFL487002R1311						
110	195	195	24...60	20...60	AF205-30-11-11	1SFL527002R1111	150...200	TA200DU-200	1SAZ421201R1006			
			100...250	100...250	AF205-30-11-13	1SFL527002R1311						

(1) For other control voltages, see "Voltage code table".

Note : for rated power above 110 kW, refer to "Starters protected by electronic overload relays".

Direct-on-line starters protected by electronic overload relays

With AF contactors - Open type version in kit form

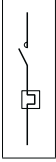
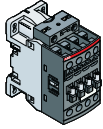
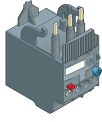
		Contactors				Electronic overload relays			Accessories
									
IEC		Control voltage Uc min. ... Uc max. (1)		Type	Order code	Setting ranges	Type	Order code	
AC-3, 400 V	Rated power								
	kW	Rated current A	V 50/60 Hz	V DC			A		
4	8.5	24...60	20...60	AF09Z-30-10-21	1SBL136001R2110	5.70...18.9	EF19-18.9	1SAX121001R1105	
		100...250	100...250	AF09-30-10-13	1SBL137001R1310				
5.5	11.5	24...60	20...60	AF12Z-30-10-21	1SBL156001R2110	5.70...18.9	EF19-18.9	1SAX121001R1105	
		100...250	100...250	AF12-30-10-13	1SBL157001R1310				
7.5	15.5	24...60	20...60	AF16Z-30-10-21	1SBL176001R2110	5.70...18.9	EF19-18.9	1SAX121001R1105	
		100...250	100...250	AF16-30-10-13	1SBL177001R1310				
11	22	24...60	20...60	AF26Z-30-00-21	1SBL236001R2100	9.00...30.0	EF45-30	1SAX221001R1101	
		100...250	100...250	AF26-30-00-13	1SBL237001R1300				
15	29	24...60	20...60	AF30Z-30-00-21	1SBL276001R2100	9.00...30.0	EF45-30	1SAX221001R1101	
		100...250	100...250	AF30-30-00-13	1SBL277001R1300				
18.5	35	24...60	20...60	AF38Z-30-00-21	1SBL296001R2100	15.0...45.0	EF45-45	1SAX221001R1102	
		100...250	100...250	AF38-30-00-13	1SBL297001R1300				
18.5	35	24...60	20...60	AF40-30-00-11	1SBL347001R1100	25.0...70.0	EF65-70	1SAX331001R1101	
		100...250	100...250	AF40-30-00-13	1SBL347001R1300				
22	41	24...60	20...60	AF52-30-00-11	1SBL367001R1100	25.0...70.0	EF65-70	1SAX331001R1101	
		100...250	100...250	AF52-30-00-13	1SBL367001R1300				
30	55	24...60	20...60	AF65-30-00-11	1SBL387001R1100	25.0...70.0	EF65-70	1SAX331001R1101	
		100...250	100...250	AF65-30-00-13	1SBL387001R1300				
37	66	24...60	20...60	AF80-30-00-11	1SBL397001R1100	36...100	EF96-100	1SAX341001R1101	
		100...250	100...250	AF80-30-00-13	1SBL397001R1300				
45	80	24...60	20...60	AF96-30-00-11	1SBL407001R1100	36...100	EF96-100	1SAX341001R1101	
		100...250	100...250	AF96-30-00-13	1SBL407001R1300				
55	97	24...60	20...60	AF116-30-11-11	1SFL427001R1111	54...150	EF146-150	1SAX351001R1101	
		100...250	100...250	AF116-30-11-13	1SFL427001R1311				
75	132	24...60	20...60	AF140-30-11-11	1SFL447001R1111	54...150	EF146-150	1SAX351001R1101	
		100...250	100...250	AF140-30-11-13	1SFL447001R1311				
90	160	24...60	20...60	AF190-30-11-11	1SFL487002R1111	63...210	EF205-210	1SAX531001R1101	
		100...250	100...250	AF190-30-11-13	1SFL487002R1311				
110	195	24...60	20...60	AF205-30-11-11	1SFL527002R1111	63...210	EF205-210	1SAX531001R1101	
		100...250	100...250	AF205-30-11-13	1SFL527002R1311				
132	230	24...60	20...60	AF265-30-11-11	1SFL547002R1111	115...380	EF370-380	1SAX611001R1101	
		100...250	100...250	AF265-30-11-13	1SFL547002R1311				
160	280	24...60	20...60	AF305-30-11-11	1SFL587002R1111	115...380	EF370-380	1SAX611001R1101	
		100...250	100...250	AF305-30-11-13	1SFL587002R1311				
200	350	24...60	20...60	AF370-30-11-11	1SFL607002R1111	115...380	EF370-380	1SAX611001R1101	
		100...250	100...250	AF370-30-11-13	1SFL607002R1311				

(1) For other control voltages, see "Voltage code table".

Reversing starters protected by electronic overload relays

With AF contactors - Open type version in kit form

IEC		Control voltage				Type	Order code	Electronic overload relays			Accessories	
AC-3, 400 V	Rated power kW	Rated current A	Uc min. ... Uc max. (1)		Type	Order code	Setting ranges A	Type	Order code	Type	Order code	
			V 50/60 Hz	V DC								
4	8.5	8.5	24...60	20...60	AF09Z-30-10-21	1SBL136001R2110	5.70...18.9	EF19-18.9	1SAX121001R1105	+	BER16-4 VEM4	1SBN081311R1000 1SBN030111R1000
			100...250	100...250	AF09-30-10-13	1SBL137001R1310						
5.5	11.5	11.5	24...60	20...60	AF12Z-30-10-21	1SBL156001R2110	5.70...18.9	EF19-18.9	1SAX121001R1105			
			100...250	100...250	AF12-30-10-13	1SBL157001R1310						
7.5	15.5	15.5	24...60	20...60	AF16Z-30-10-21	1SBL176001R2110	5.70...18.9	EF19-18.9	1SAX121001R1105			
			100...250	100...250	AF16-30-10-13	1SBL177001R1310						
11	22	22	24...60	20...60	AF26Z-30-00-21	1SBL236001R2100	9.00...30.0	EF45-30	1SAX221001R1101	+	BER38-4 VEM4	1SBN082311R1000 1SBN030111R1000
			100...250	100...250	AF26-30-00-13	1SBL237001R1300						
15	29	29	24...60	20...60	AF30Z-30-00-21	1SBL276001R2100	9.00...30.0	EF45-30	1SAX221001R1101	+ 2x	CA4-10	1SBN010110R1010
			100...250	100...250	AF30-30-00-13	1SBL277001R1300						
18.5	35	35	24...60	20...60	AF38Z-30-00-21	1SBL296001R2100	15.0...45.0	EF45-45	1SAX221001R1102			
			100...250	100...250	AF38-30-00-13	1SBL297001R1300						
18.5	35	35	24...60	20...60	AF40-30-00-11	1SBL347001R1100	25.0...70.0	EF65-70	1SAX331001R1101	+	BER65-4 VM96-4	1SBN083411R1000 1SBN033405T1000
			100...250	100...250	AF40-30-00-13	1SBL347001R1300						
22	41	41	24...60	20...60	AF52-30-00-11	1SBL367001R1100	25.0...70.0	EF65-70	1SAX331001R1101	+ 2x	CA4-10	1SBN010110R1010
			100...250	100...250	AF52-30-00-13	1SBL367001R1300						
30	55	55	24...60	20...60	AF65-30-00-11	1SBL387001R1100	25.0...70.0	EF65-70	1SAX331001R1101	+ 2x	CA4-01	1SBN010110R1001
			100...250	100...250	AF65-30-00-13	1SBL387001R1300						
37	66	66	24...60	20...60	AF80-30-00-11	1SBL397001R1100	36...100	EF96-100	1SAX341001R1101	+	BER96-4 VM96-4	1SBN083911R1000 1SBN033405T1000
			100...250	100...250	AF80-30-00-13	1SBL397001R1300						
45	80	80	24...60	20...60	AF96-30-00-11	1SBL407001R1100	36...100	EF96-100	1SAX341001R1101	+ 2x	CA4-10 CA4-01	1SBN010110R1010 1SBN010110R1001
			100...250	100...250	AF96-30-00-13	1SBL407001R1300						
55	97	97	24...60	20...60	AF116-30-11-11	1SFL427001R1111	54...150	EF146-150	1SAX351001R1101	+	BER140-4 VM19	1SFN084211R1000 1SFN030300R1000
			100...250	100...250	AF116-30-11-13	1SFL427001R1311						
75	132	132	24...60	20...60	AF140-30-11-11	1SFL447001R1111	54...150	EF146-150	1SAX351001R1101			
			100...250	100...250	AF140-30-11-13	1SFL447001R1311						
90	160	160	24...60	20...60	AF190-30-11-11	1SFL487002R1111	63...210	EF205-210	1SAX531001R1101	+	BER205-4 VM19	1SFN084811R1000 1SFN030300R1000
			100...250	100...250	AF190-30-11-13	1SFL487002R1311						
110	195	195	24...60	20...60	AF205-30-11-11	1SFL527002R1111	63...210	EF205-210	1SAX531001R1101			
			100...250	100...250	AF205-30-11-13	1SFL527002R1311						
132	230	230	24...60	20...60	AF265-30-11-11	1SFL547002R1111	115...380	EF370-380	1SAX611001R1101	+	BER370-4 VM19	1SFN085411R1000 1SFN030300R1000
			100...250	100...250	AF265-30-11-13	1SFL547002R1311						
160	280	280	24...60	20...60	AF305-30-11-11	1SFL587002R1111	115...380	EF370-380	1SAX611001R1101			
			100...250	100...250	AF305-30-11-13	1SFL587002R1311						
200	350	350	24...60	20...60	AF370-30-11-11	1SFL607002R1111	115...380	EF370-380	1SAX611001R1101			
			100...250	100...250	AF370-30-11-13	1SFL607002R1311						

(1) For other control voltages, see "Voltage code table".

DOL and reversing starters protected by overload relays

With AF contactors - Open type version in kit form

Switching frequency diagrams

General

Overload relays cannot be operated at any arbitrary switching frequency in order to avoid tripping. Applications involving up to 15 operations per hour are acceptable. Higher switching frequencies are permitted if the duty ratio and the motor starting time are allowed for and if the motor's making current does not appreciably exceed 6 times the rated operating current. Please refer to the adjacent diagram for guideline values for the permitted switching frequency.

Thermal overload relay

Intermittent periodic duty

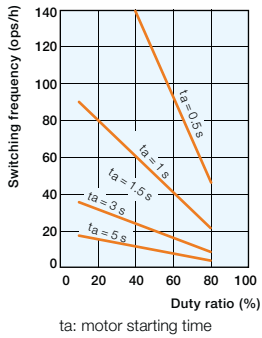

Example:

Starting time of the motor: 1 second - Duty ratio: 40 % means a permitted switching frequency of max. 60 operating cycles per hour.

Electronic overload relay

Intermittent periodic duty

Trip class 10E

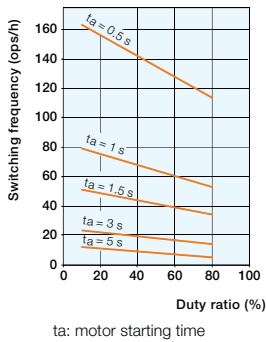

Trip class 20E

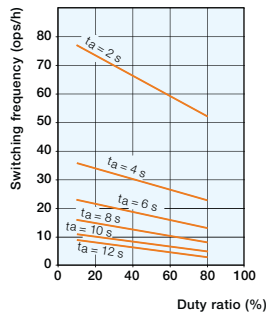

Trip class 30E

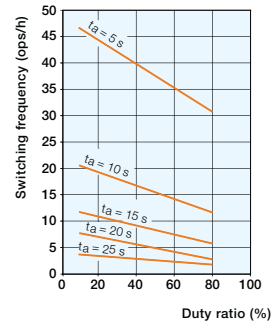

Example for trip class 10E:

Starting time of the motor: 1 second. Duty ratio: 60 % means a permitted switching frequency of max. 60 operating cycles per hour, for a motor breaking current not exceeding 6 x In.

DOL and reversing starters protected by overload relays

With AF contactors - Open type version in kit form

Wiring diagrams

Direct-on-line starters

Power circuit

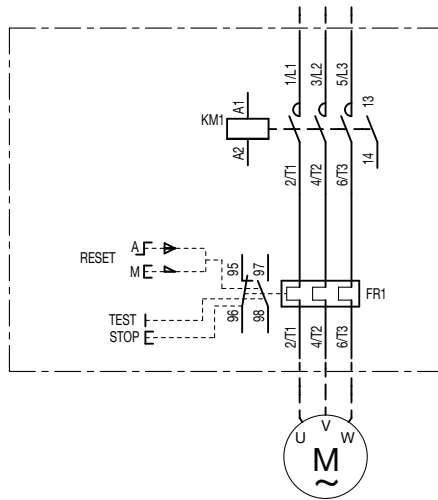

1-phase

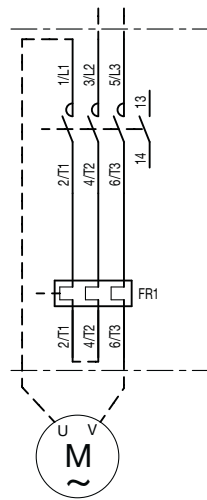

AC or DC local control

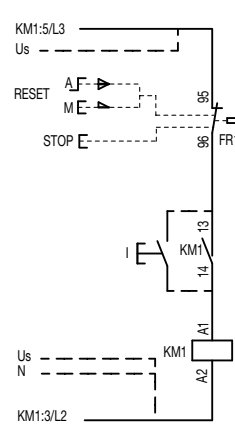

AC or DC remote control

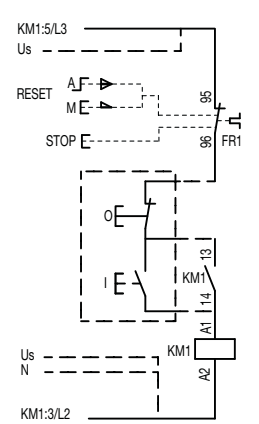

Note: coil U_c 12-20 V DC : A1+, A2-

Reversing starters

Power circuit

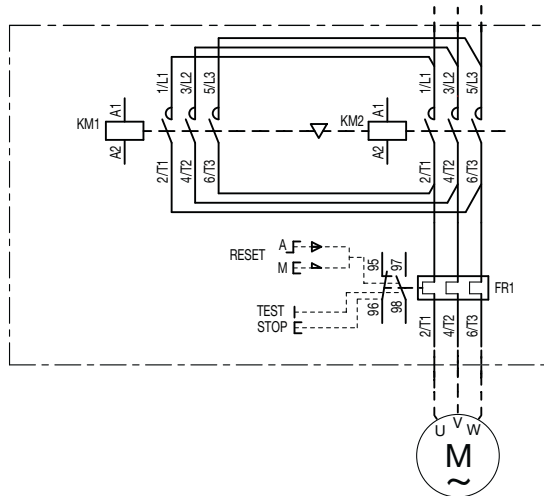

AC or DC local control

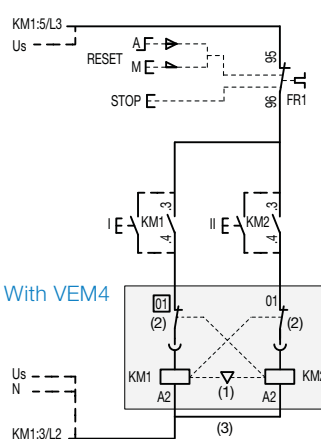

With VM

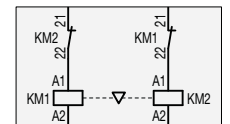

AC or DC remote control

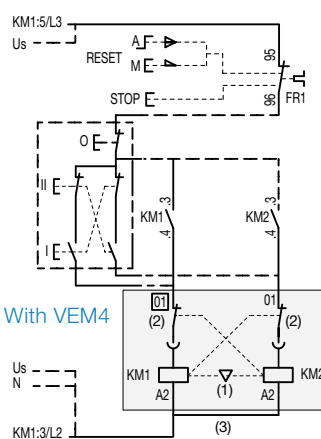

With VM

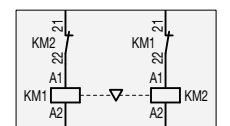

Note: - VEM4 = VM4 (1) + VE4 (2) with A2-A2 (3) connection
 (Except for coil U_c 12-20 V DC : use VM4 with CA4).
 - coil U_c 12-20 V DC : A1+, A2-

DOL starters protected by thermal overload relays With AF contactors - open type version in kit form

Main dimensions mm, inches

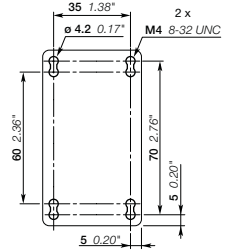
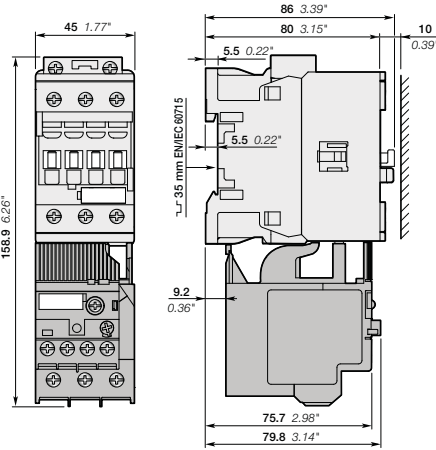
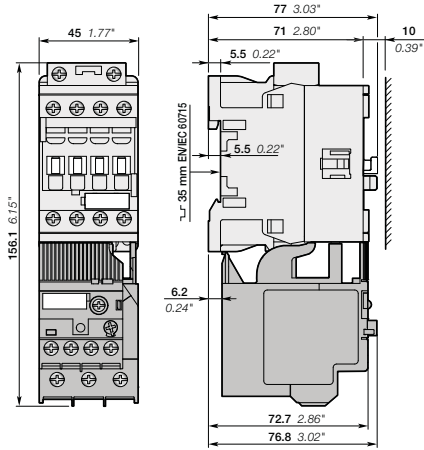

AF09, AF12, AF16
+ TF42 thermal overload relay

AF26, AF30, AF38
+ TF42 thermal overload relay

Note: contactor lateral distance to grounded component 2 mm 0.08" min.

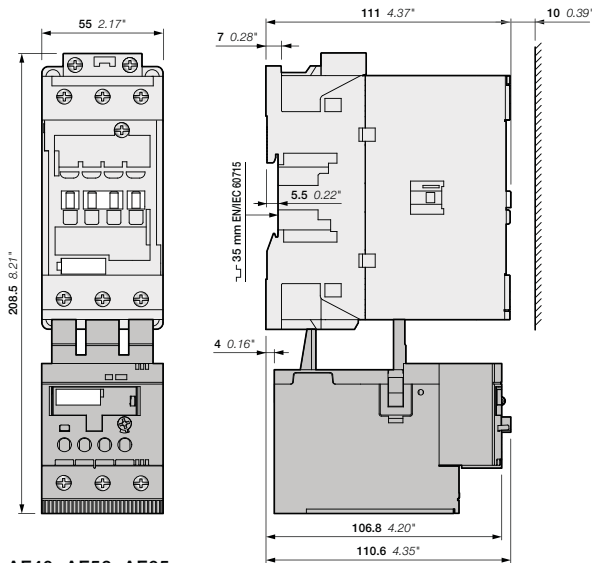

AF40, AF52, AF65
+ TF65 thermal overload relay

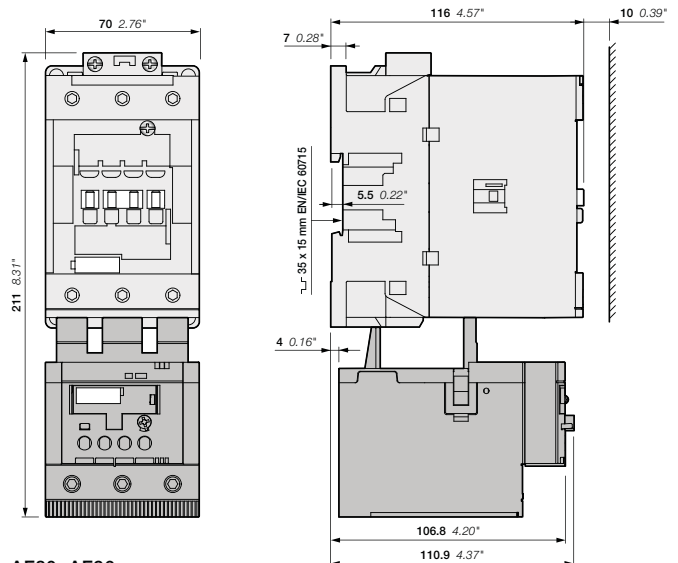

AF80, AF96
+ TF96 thermal overload relay

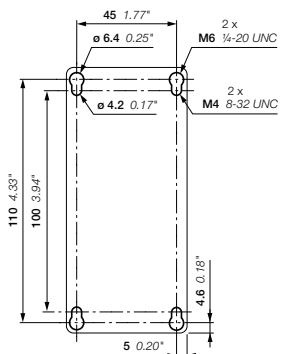

AF40, AF52, AF65
+ TF65 thermal overload relay

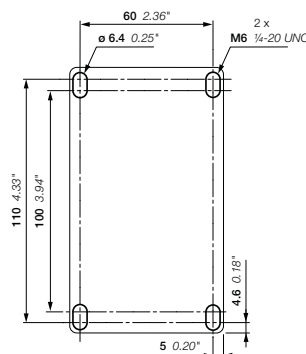

AF80, AF96
+ TF96 thermal overload relay

DOL starters protected by thermal overload relays With AF contactors - open type version in kit form

Main dimensions mm, inches

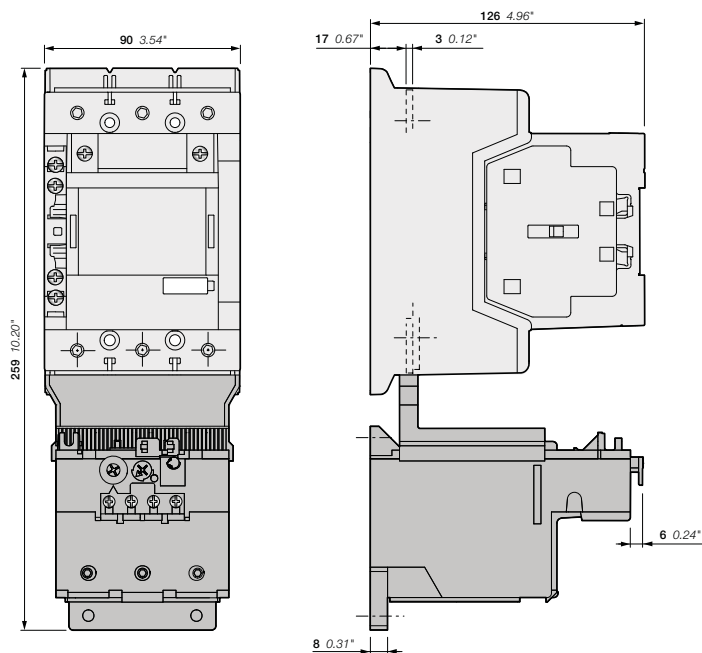

AF116, AF140-30-11(B)
+ TF140 thermal overload relay

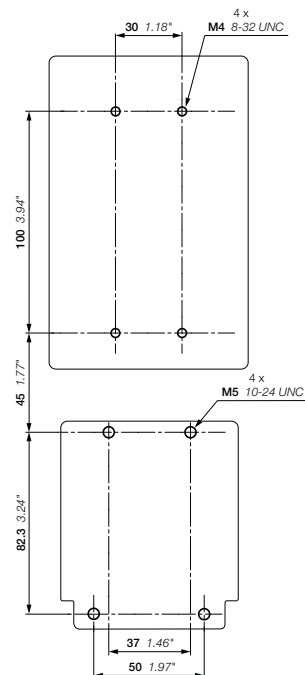

AF116, AF140-30-11(B)
+ TF140 thermal overload relay

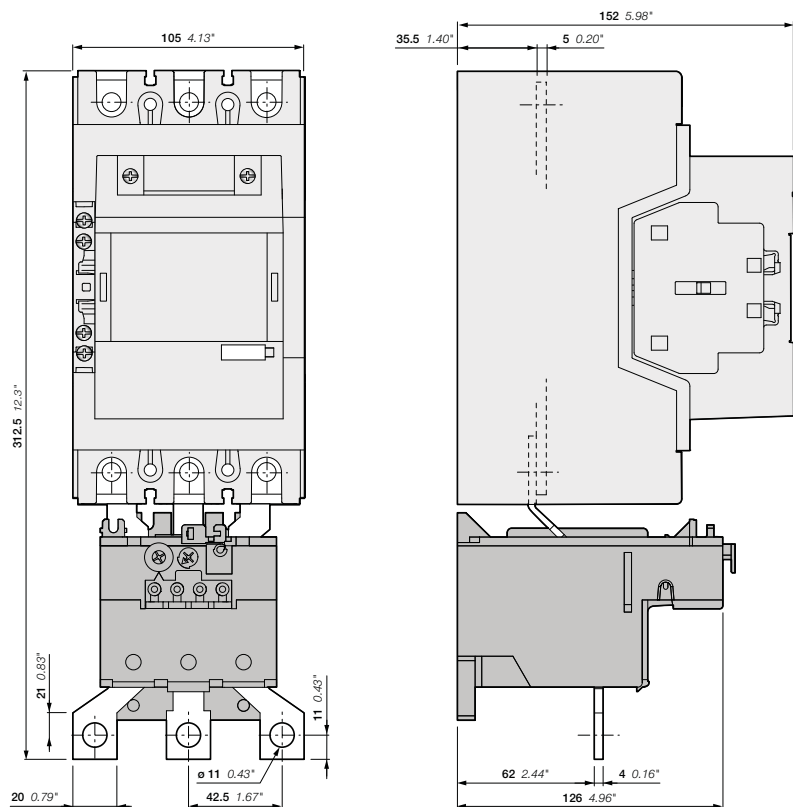

AF190, AF205-30-11
+ TA200DU thermal overload relay

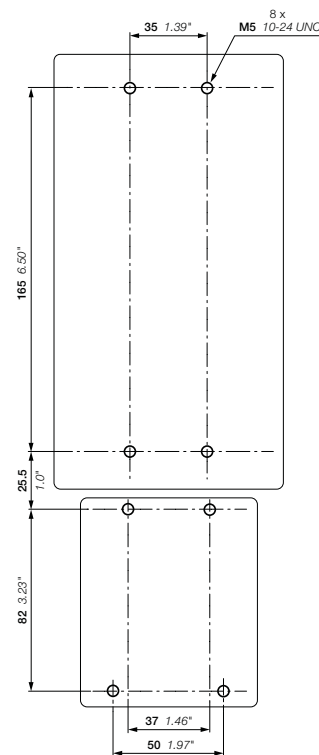

AF190, AF205
+ TA200DU thermal overload relay

Reversing starters protected by thermal overload relays With AF contactors - open type version in kit form

Main dimensions mm, inches

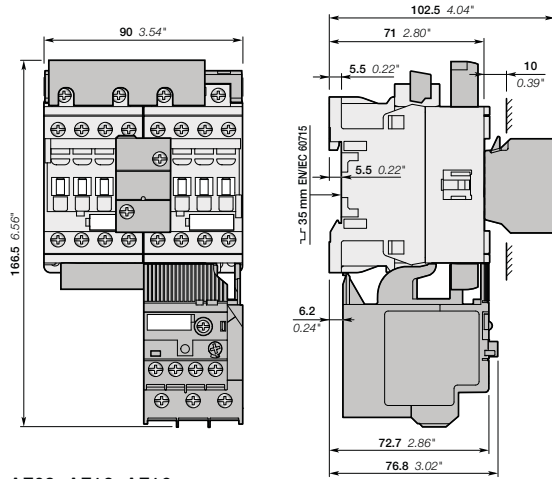

AF09, AF12, AF16
+ BER16-4, VEM4
+ TF42 thermal overload relay

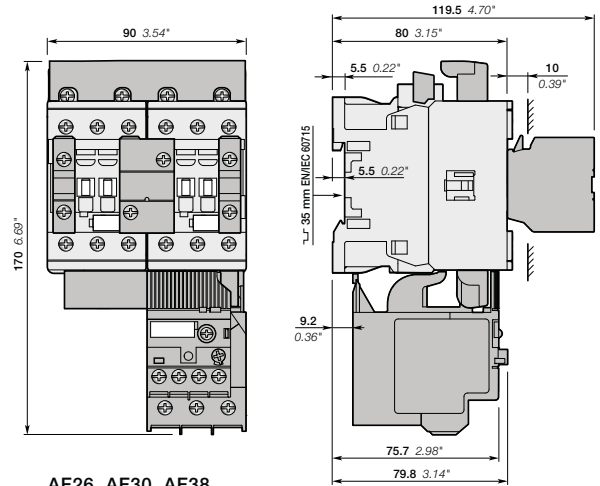

AF26, AF30, AF38
+ BER38-4, VEM4, CA4-10
+ TF42 thermal overload relay

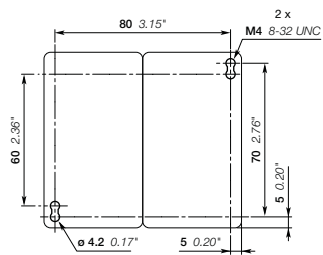

AF09, AF12, AF16, AF26, AF30, AF38

Note: contactor lateral distance to grounded component 2 mm 0.08 inches min.

Reversing starters protected by thermal overload relays With AF contactors - open type version in kit form

Main dimensions mm, inches

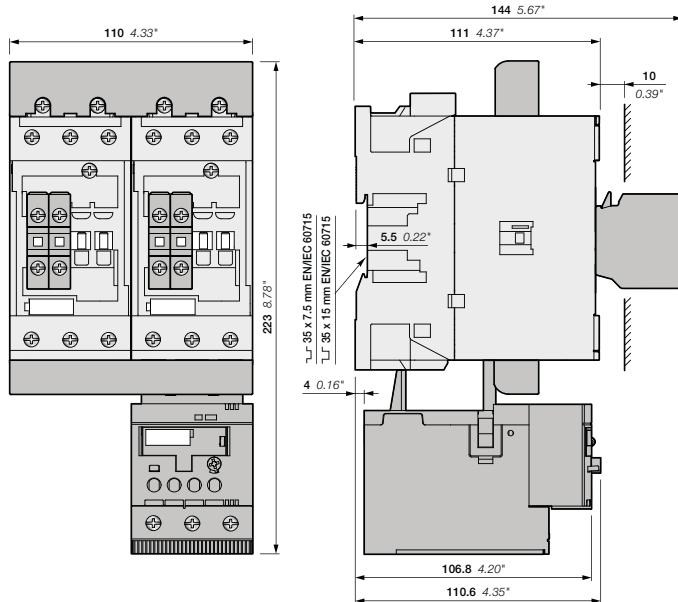

AF40, AF52, AF65
+ BER65-4, VM96-4
+ TF65 thermal overload relay

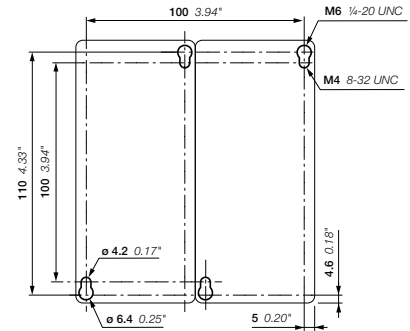

AF40, AF52, AF65
+ BER65-4, VM96-4
+ TF65 thermal overload relay

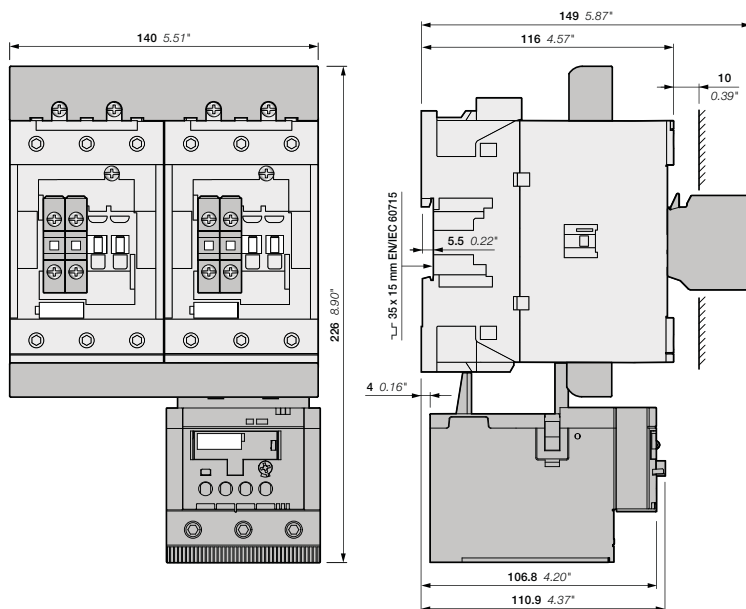

AF80, AF96
+ BER96-4, VM96-4
+ TF96 thermal overload relay

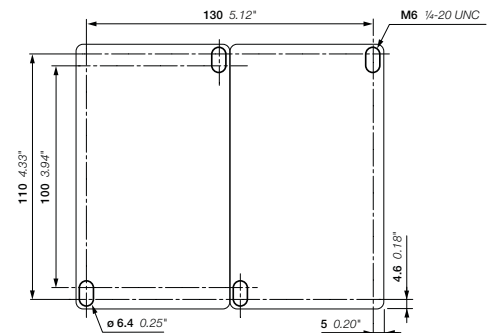

AF80, AF96
+ BER96-4, VM96-4
+ TF96 thermal overload relay

Reversing starters protected by thermal overload relays With AF contactors - open type version in kit form

Main dimensions mm, inches

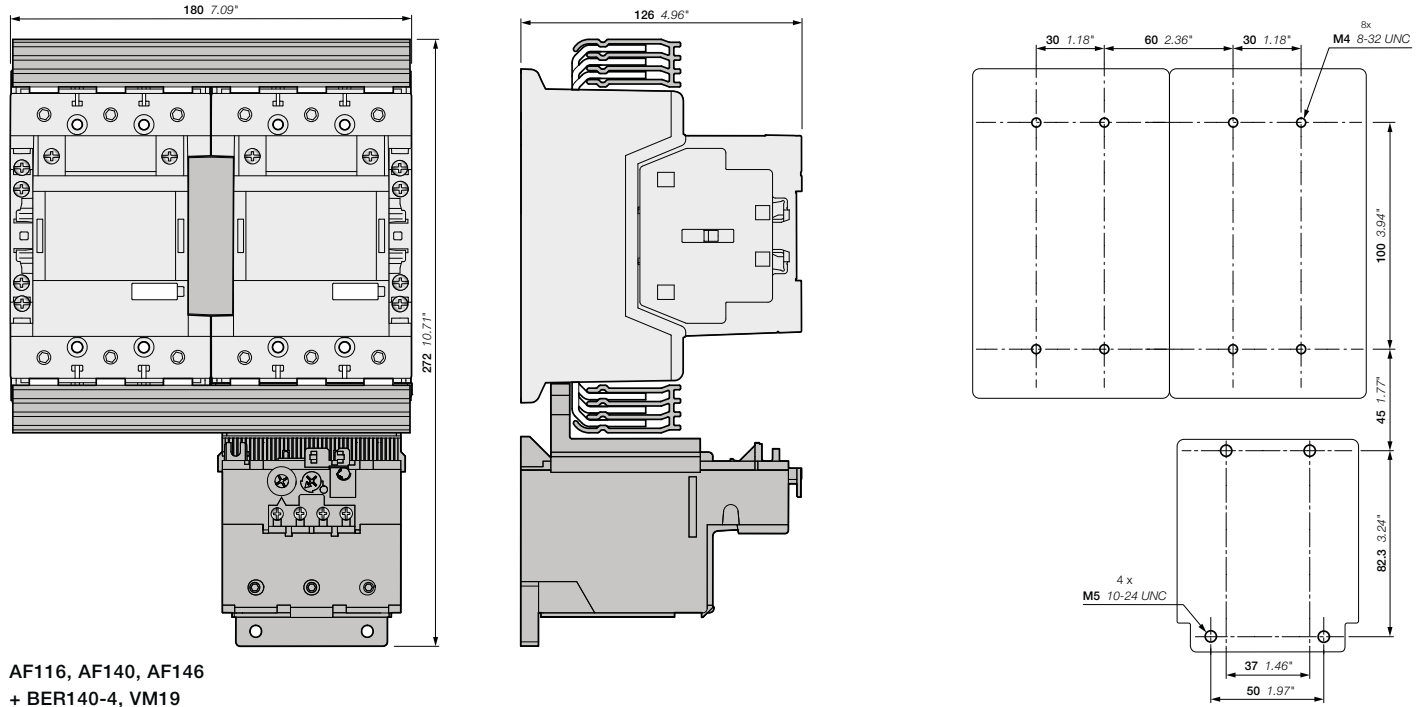

AF116, AF140, AF146
+ BER140-4, VM19
+ TF140 thermal overload relay

Reversing starters protected by thermal overload relays With AF contactors - open type version in kit form

Main dimensions mm, inches

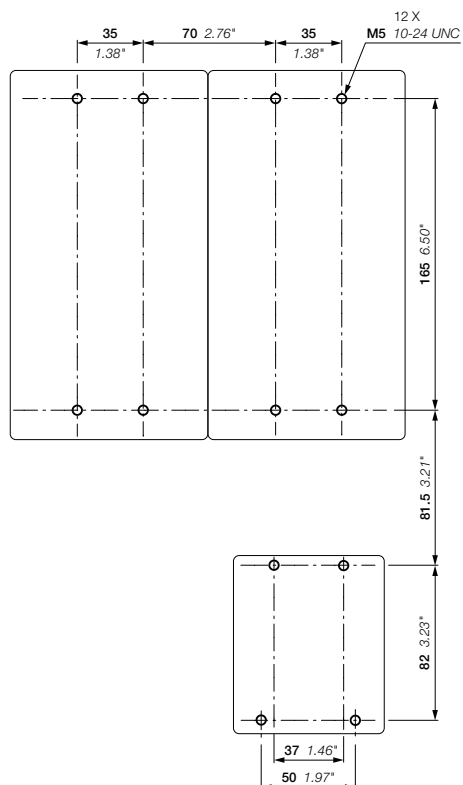
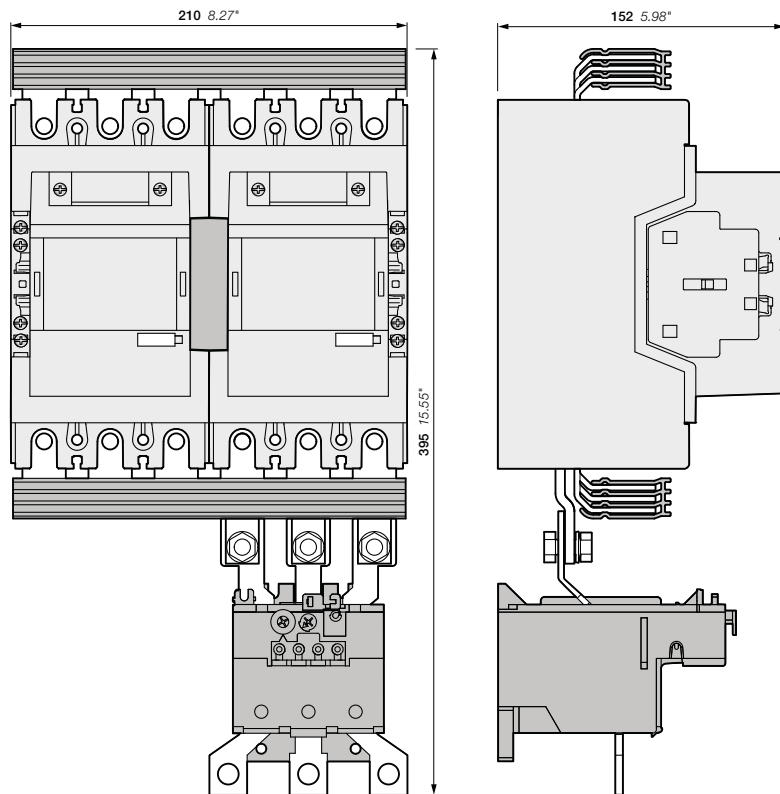

AF190, AF205
+ BER205-4, VM19
+ TA200DU thermal overload relay

DOL starters protected by electronic overload relays

With AF contactors - open type version in kit form

Main dimensions mm, inches

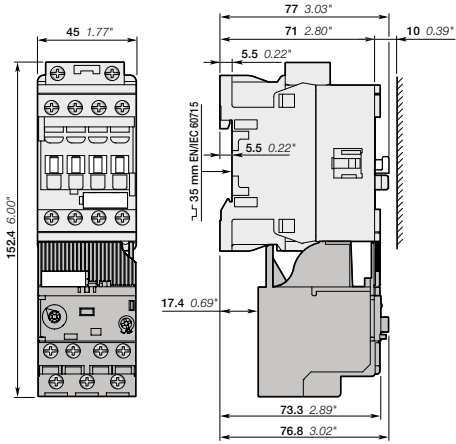

AF09, AF12, AF16
+ EF19 electronic overload relay

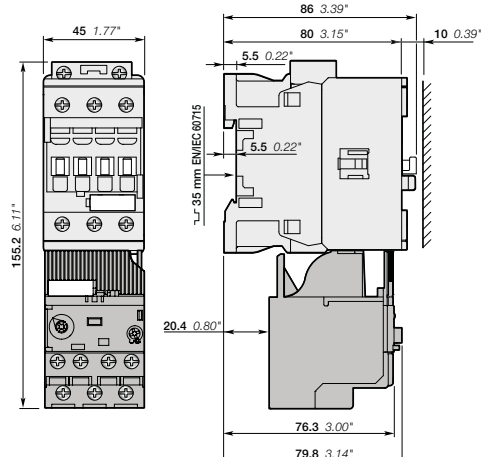

AF26, AF30, AF38
+ EF19 electronic overload relay

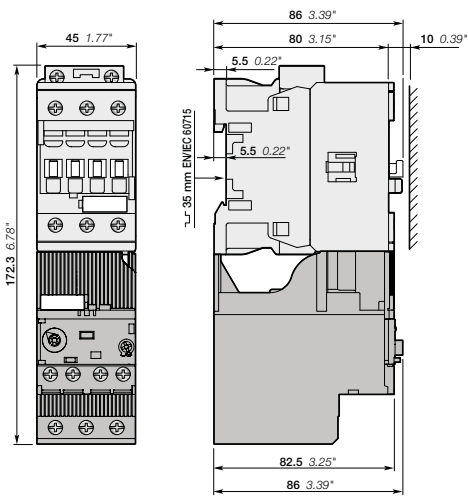

AF26, AF30, AF38
+ EF45 electronic overload relay

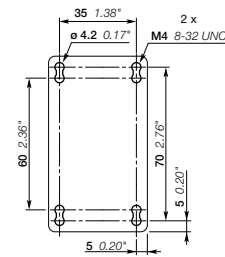

AF09, AF12, AF16, AF26, AF30, AF38
+ EF electronic overload relay

Note: contactor lateral distance to grounded component 2 mm 0.08" min.

DOL starters protected by electronic overload relays

With AF contactors - open type version in kit form

Main dimensions mm, inches

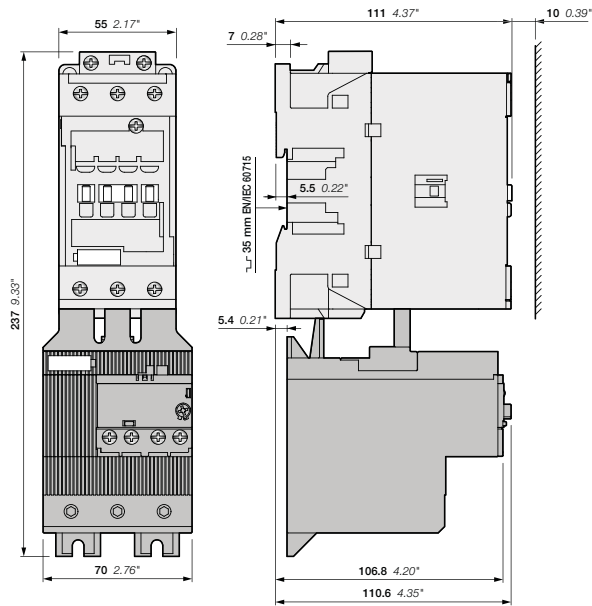

AF40, AF52, AF65
+ EF65 electronic overload relay

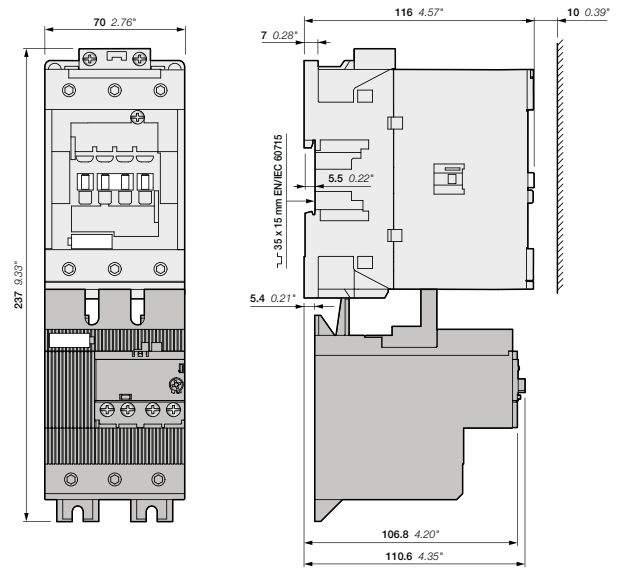

AF80, AF96
+ EF96 electronic overload relay

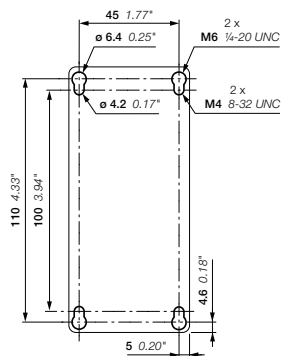

AF40, AF52, AF65
+ EF65 electronic overload relay

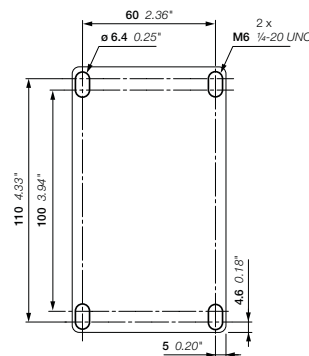

AF80, AF96
+ EF96 electronic overload relay

DOL starters protected by electronic overload relays

With AF contactors - open type version in kit form

Main dimensions mm, inches

5

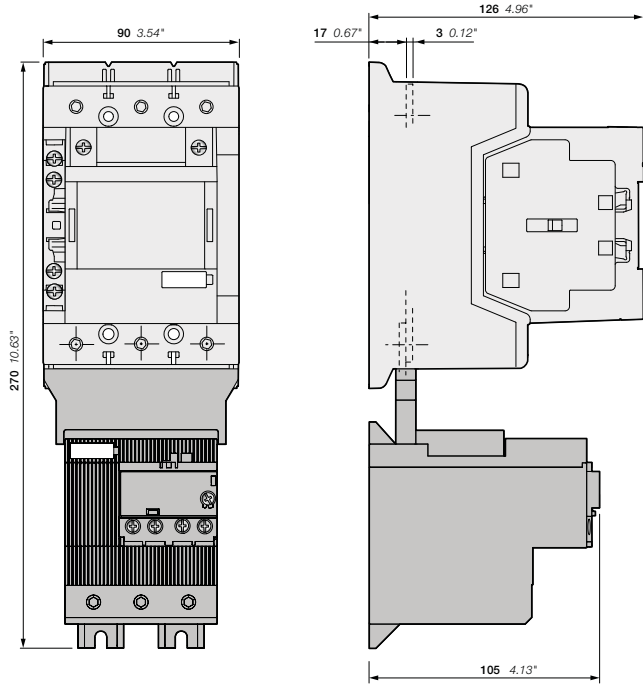

AF116, AF140, AF146-30-11(B)
+ EF146 electronic overload relay

AF116, AF140, AF146-30-11(B)
+ EF146 electronic overload relay

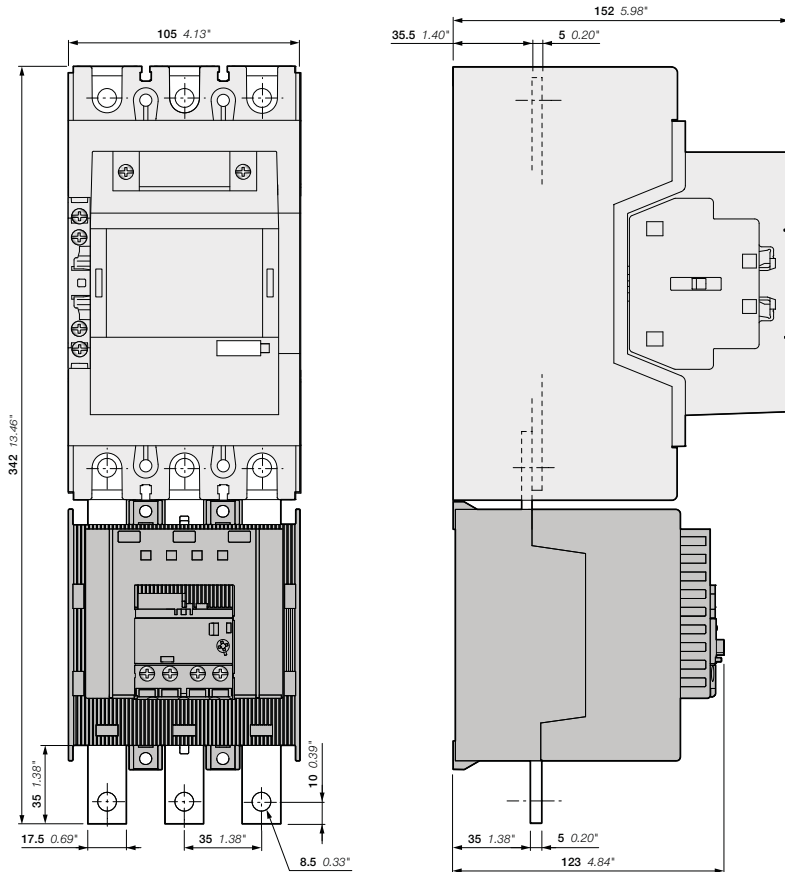

AF190, AF205-30-11
+ EF205 electronic overload relay

AF190, AF205
+ EF205 electronic overload relay

DOL starters protected by electronic overload relays

With AF contactors - open type version in kit form

Main dimensions mm, inches

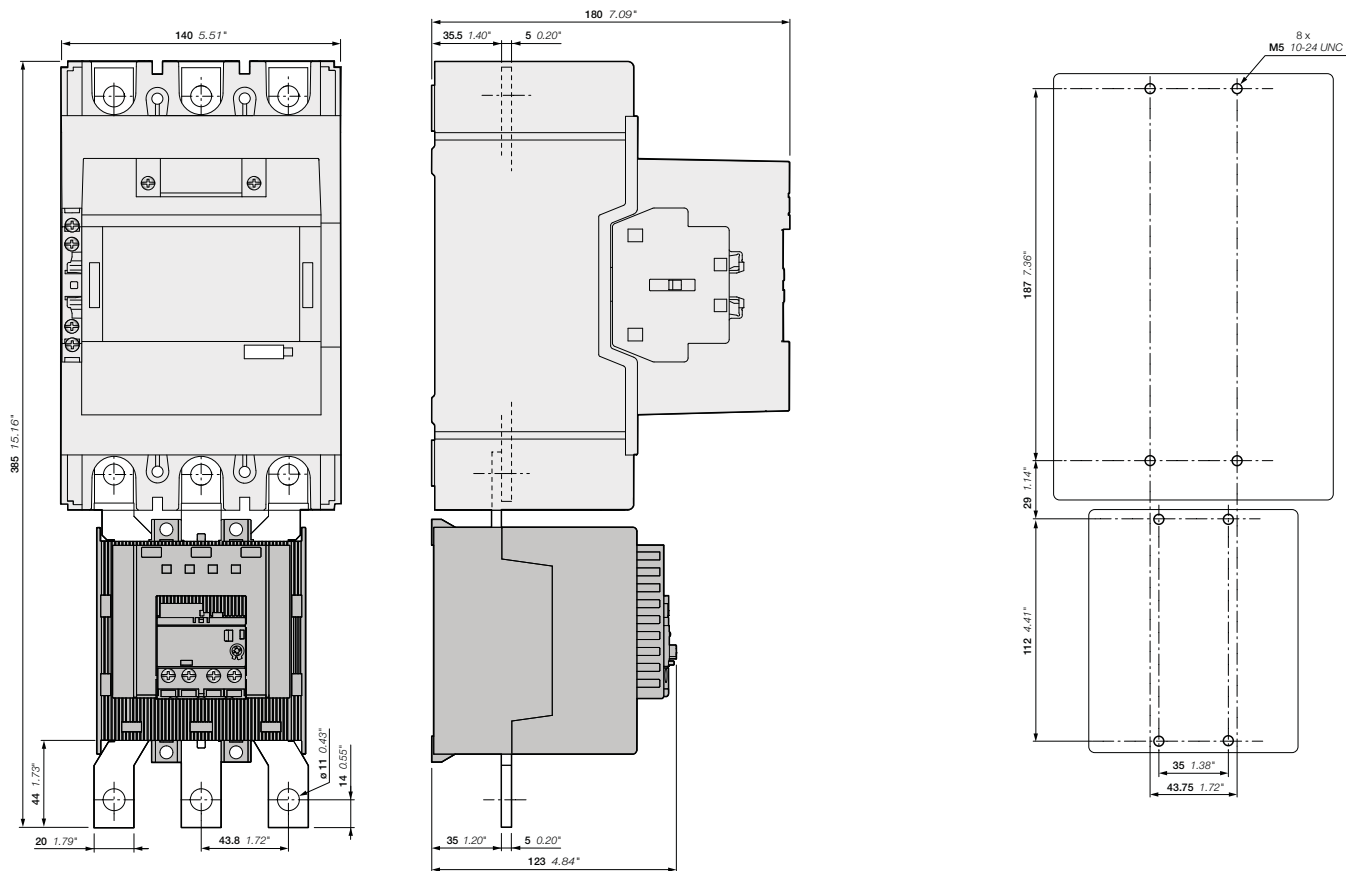

AF265, AF305, AF370-30-11
+ EF370 electronic overload relay

Reversing starters protected by electronic overload relays With AF contactors - open type version in kit form

Main dimensions mm, inches

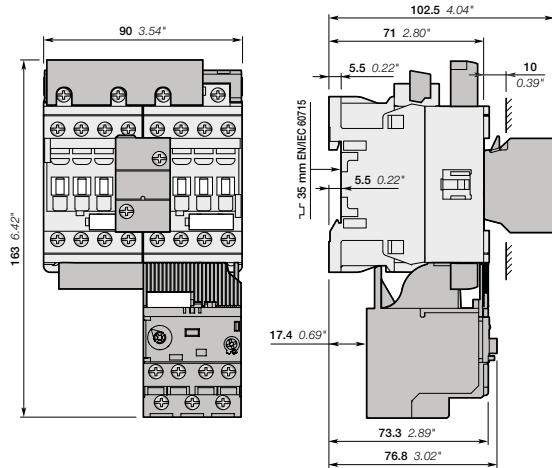

AF09, AF12, AF16
+ BER16-4, VEM4
+ EF19 electronic overload relay

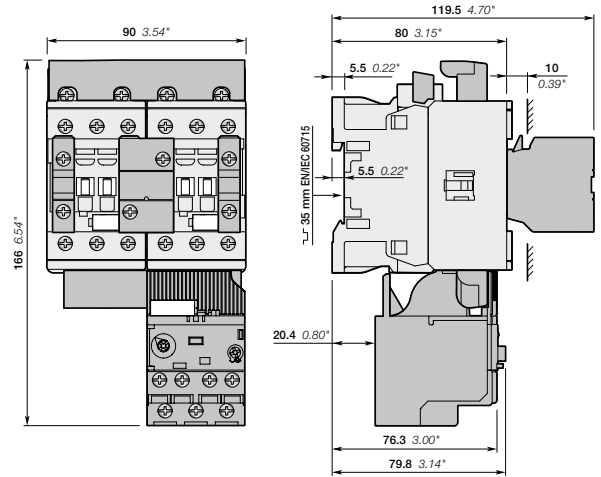

AF26, AF30, AF38
+ BER38-4, VEM4, CA4-10
+ EF19 electronic overload relay

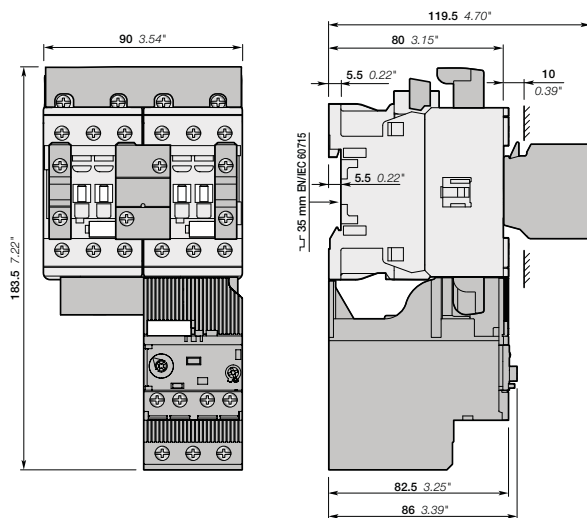

AF26, AF30, AF38
+ BER38-4, VEM4, CA4-10
+ EF45 electronic overload relay

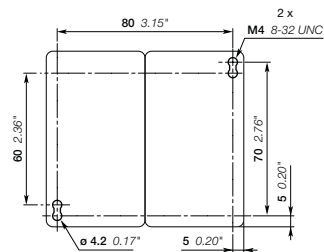

AF09, AF12, AF16, AF26, AF30, AF38

Note: contactor lateral distance to grounded component 2 mm 0.08" min.

Reversing starters protected by electronic overload relays

With AF contactors - open type version in kit form

Main dimensions mm, inches

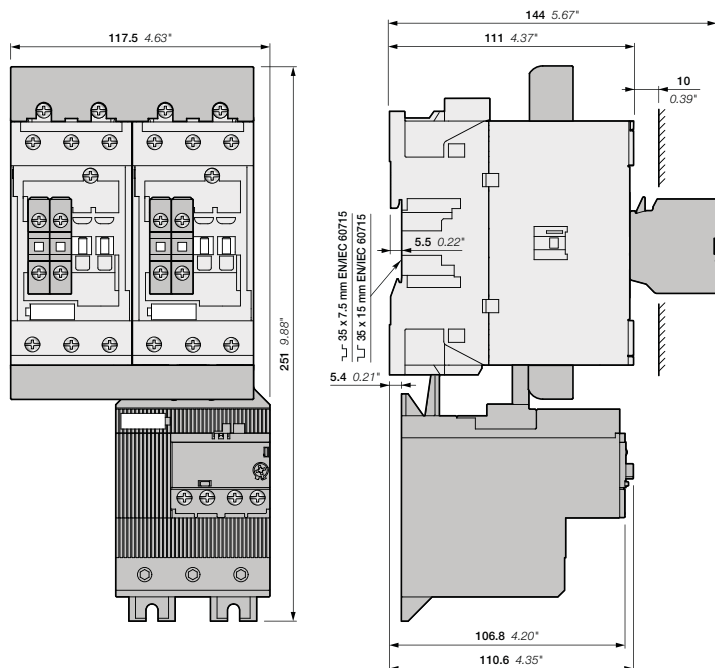

AF40, AF52, AF65
+ BER65-4, VM96-4
+ EF65 electronic overload relay

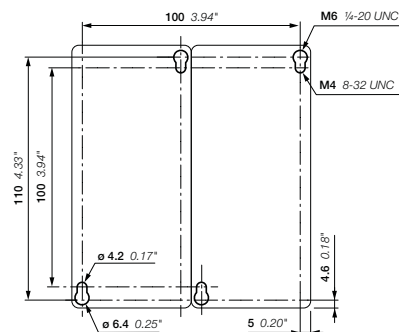

AF40, AF52, AF65
+ BER65-4, VM96-4
+ EF65 electronic overload relay

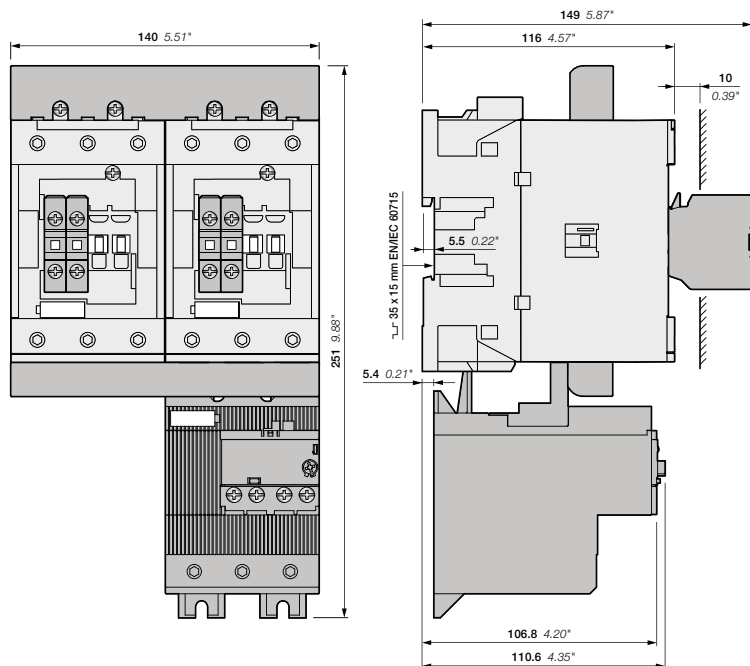

AF80, AF96
+ BER96-4, VM96-4
+ EF96 electronic overload relay

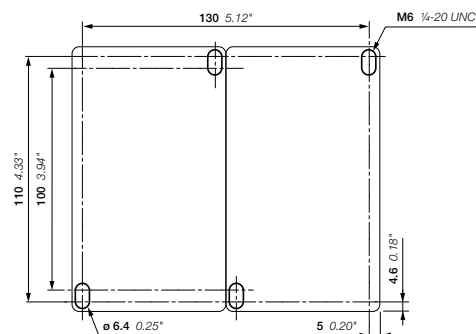

AF80, AF96
+ BER96-4, VM96-4
+ EF96 electronic overload relay

Reversing starters protected by electronic overload relays With AF contactors - open type version in kit form

Main dimensions mm, inches

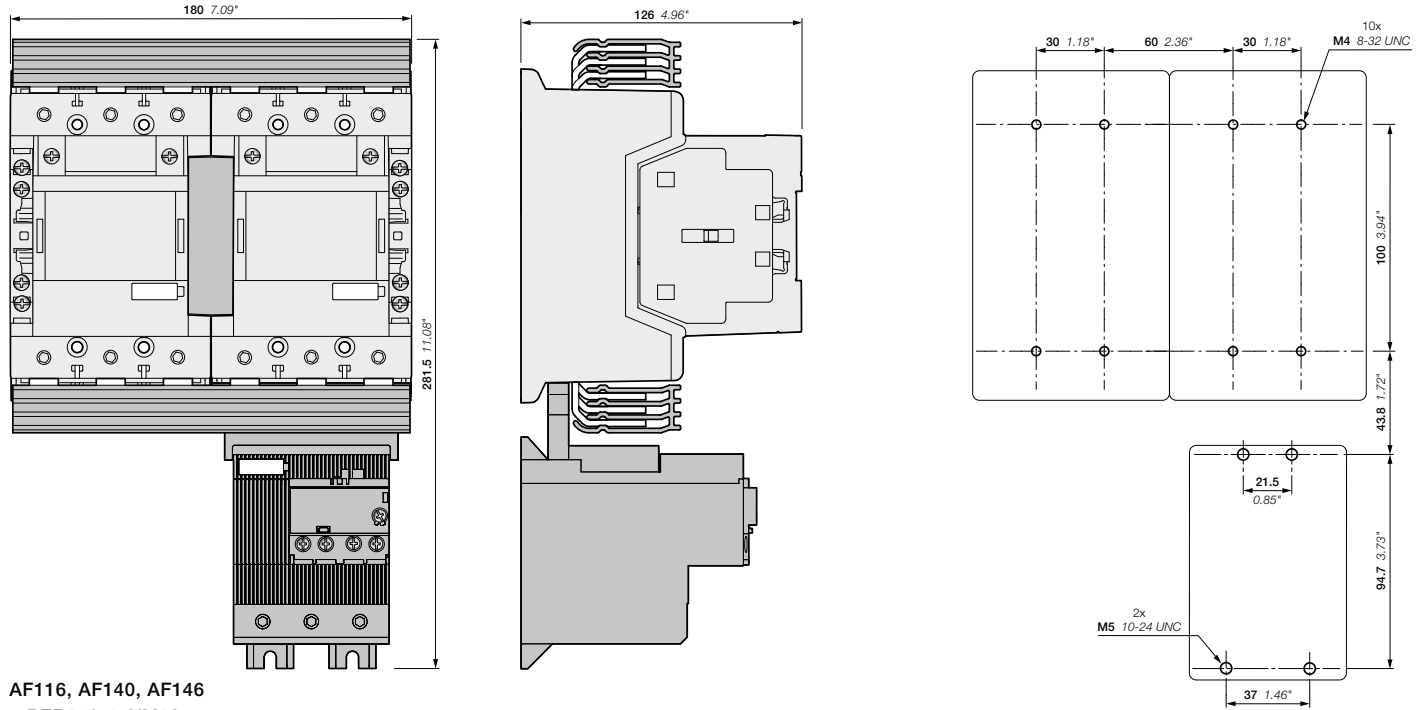

AF116, AF140, AF146
+ BER140-4, VM19
+ EF146 electronic overload relay

5

Reversing starters protected by electronic overload relays With AF contactors - open type version in kit form

Main dimensions mm, inches

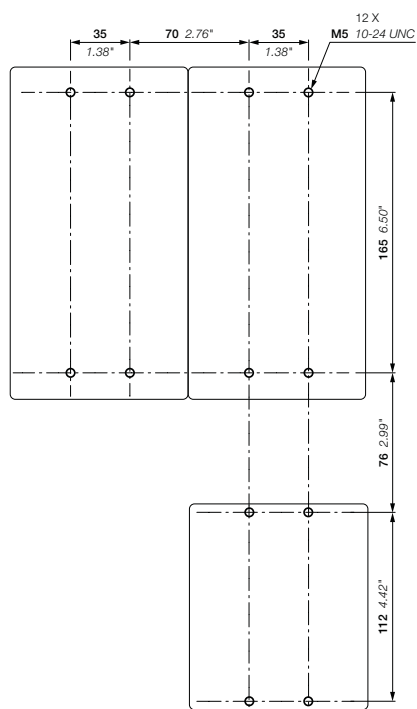
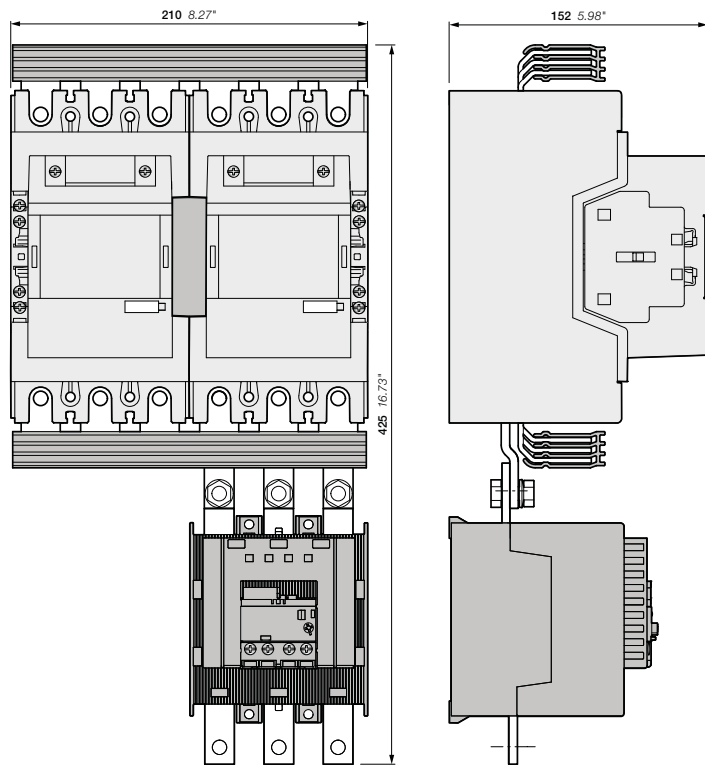

- AF190, AF205
- + BER205-4, VM19
- + EF205 electronic overload relay

Reversing starters protected by electronic overload relays With AF contactors - open type version in kit form

Main dimensions mm, inches

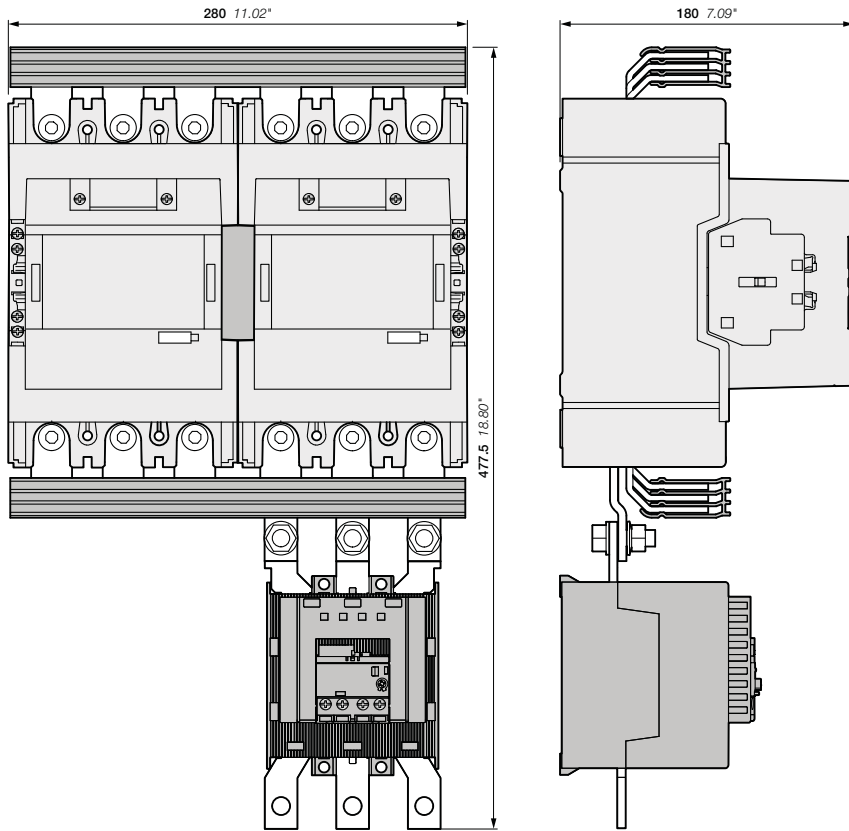

AF265, AF305, AF370
+ BER370-4, VM19
+ EF370 electronic overload relay

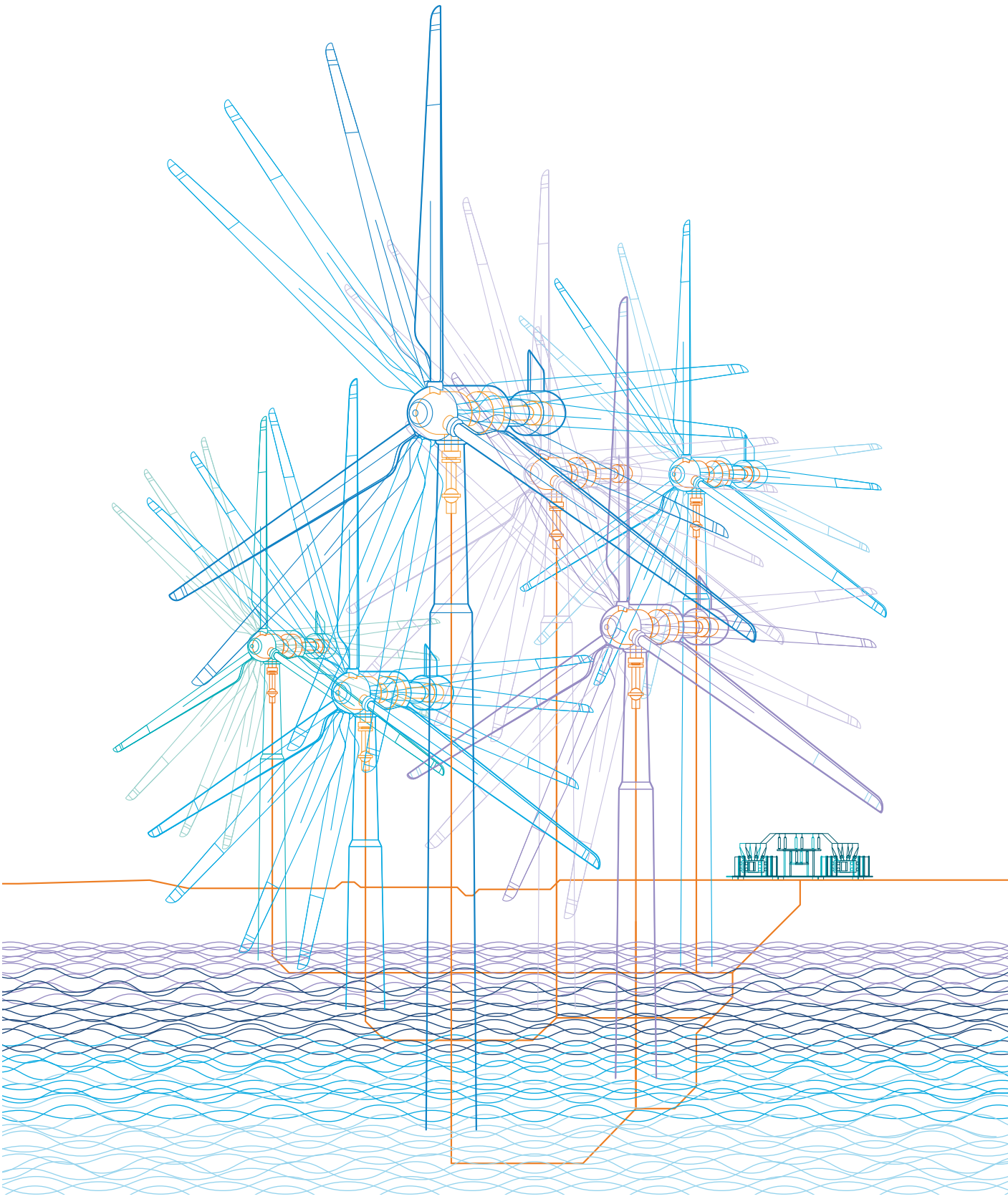

Star-delta starters protected by overload relays

With AF contactors - Open type version in kit form

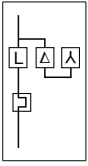

Application

Star-delta starting is the most common method to reduce the starting current of a motor.

This system can be used on all the squirrel cage motors, which are normally used in delta connection. In this type of starting, it is recommended to choose motors having high starting torque i.e. much higher than the resistive torque in order to reach sufficient high speed when the motor is connected in star.

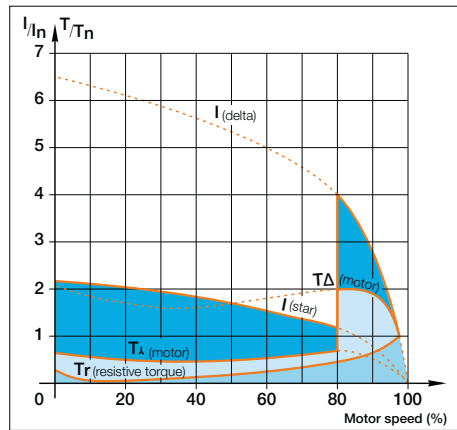

When starting:

- Inrush current is reduced to a third of direct starting current
- Motor torque is reduced to a third or even less of direct starting torque.

Transient current is generated when switching from star to delta connection.

During the initial starting phase ("star" connection), the resistive torque of the driven load must remain, irrespective of speed, less than the "star" motor torque until "star-delta" switching occurs.

This starting mode is therefore ideal for machines having low starting torque such as pumps, centrifugal compressors, wood-working machines...

I = current
T = torque
In = nominal current
Tn = nominal torque

Precaution

- Motor nominal voltage in delta connection must be equal to that of the mains. Example: a motor for 400 V star-delta starting must be designed for 400 V in "delta" connection. Its usual designation is "400 V / 690 V motor". The motor must be constructed with 6 terminal windings
- In order to prevent a high current peak, at least 85 % of nominal speed must be reached before switching from star to delta

Sequence

Starting is a three-stage process:

1st stage: "Star" connection - Press the "On" button on the control circuit to close the KM2 "Star" contactor. The KM1 "line" contactor then closes and the motor starts. Countdown of programmed starting time (6 to 10 s) then begins.

2nd stage: "Star" to "Delta" switching - when programmed starting time is over, the KM2 "Star" contactor opens.

3rd stage: "Delta" connection - Thanks to AF contactors, a transition time (or dwelling time) of 50 ms is already integrated between the opening of the "star" contactor and closing of the "delta" contactor.

Conclusion: An on-delay timer without dwelling time (e.g.: CT-ERS.21S or TEF4-ON) is enough to count-down the programmed starting time (6 to 10 s) during "Star connection". The use of a star-delta timer including a dwelling time is not permitted.

Main Technical Data

Standards	IEC 60947-4-1 / EN 60947-4-1
Rated operational voltage Ue max.	690 V - 50/60 Hz
Rated insulation voltage Ui	
acc. to IEC 60947-4-1	690 V
acc. to UL / CSA	600 V
Ambient air temperature	
Close to the device	≤ 60 °C (TF42: 38 A above ≤ 50 °C)
Degree of protection	IP20
Switching frequency	Refer to "Switching frequency diagrams" page

Mounting positions

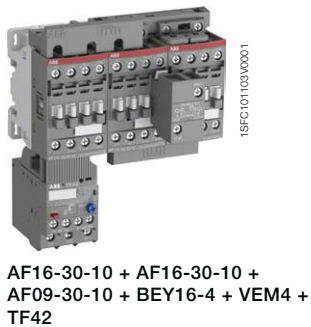
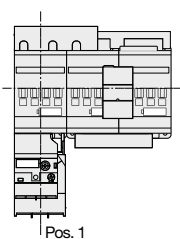

Star-delta starters protected by overload relays

With AF contactors - Open type version in kit form

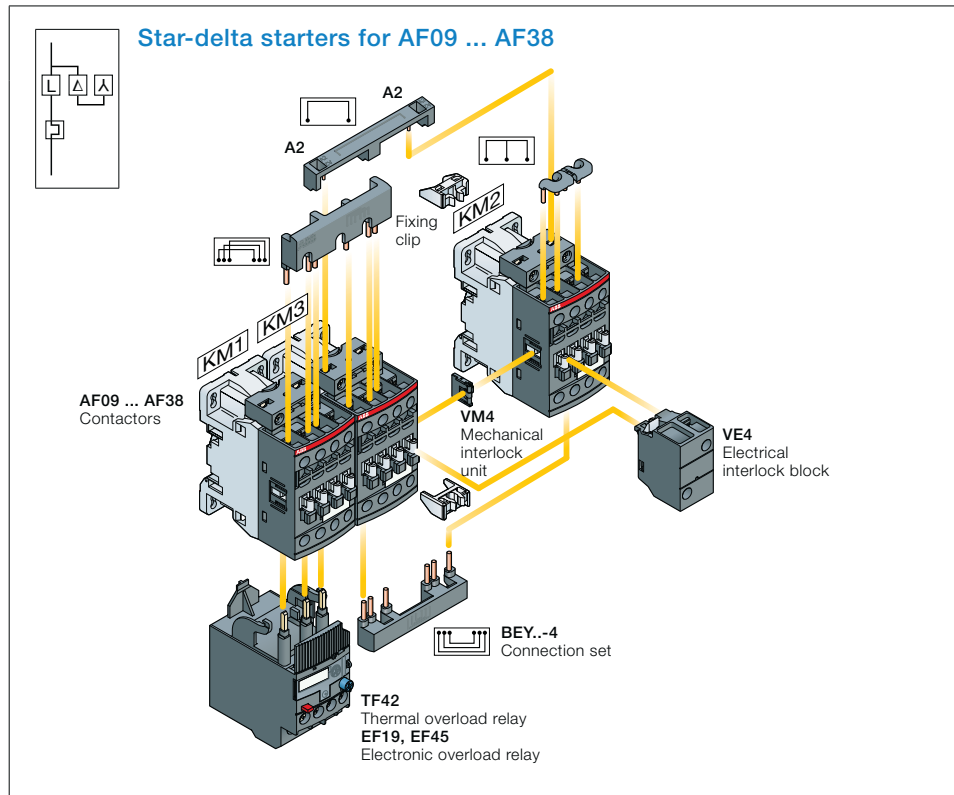

Description

You can easily assemble star-delta starter thanks to our complete range of accessories:

- For AF09 ... AF38, use VEM4 mechanical and electrical interlock set without increasing starter width. It includes:
 - VM4 mechanical interlock unit and 2 fixing clips
 - VE4 electrical interlock block with A2-A2 connection.
- For AF40 ... AF370, use VM mechanical interlock unit and additional auxiliary contact blocks for electrical interlocking.
- BEY...-4 connection set: it assures a safe and simple connection between both contactor main terminals.

Select now easily and quickly your starter in the following pages at 400 V, up to 200 kW.

For the full coordination tables: www.abb.com/lowvoltage then go to the right menu: "Support", select: "Online Product Selection Tools" then select "Coordination Tables for motor protection"

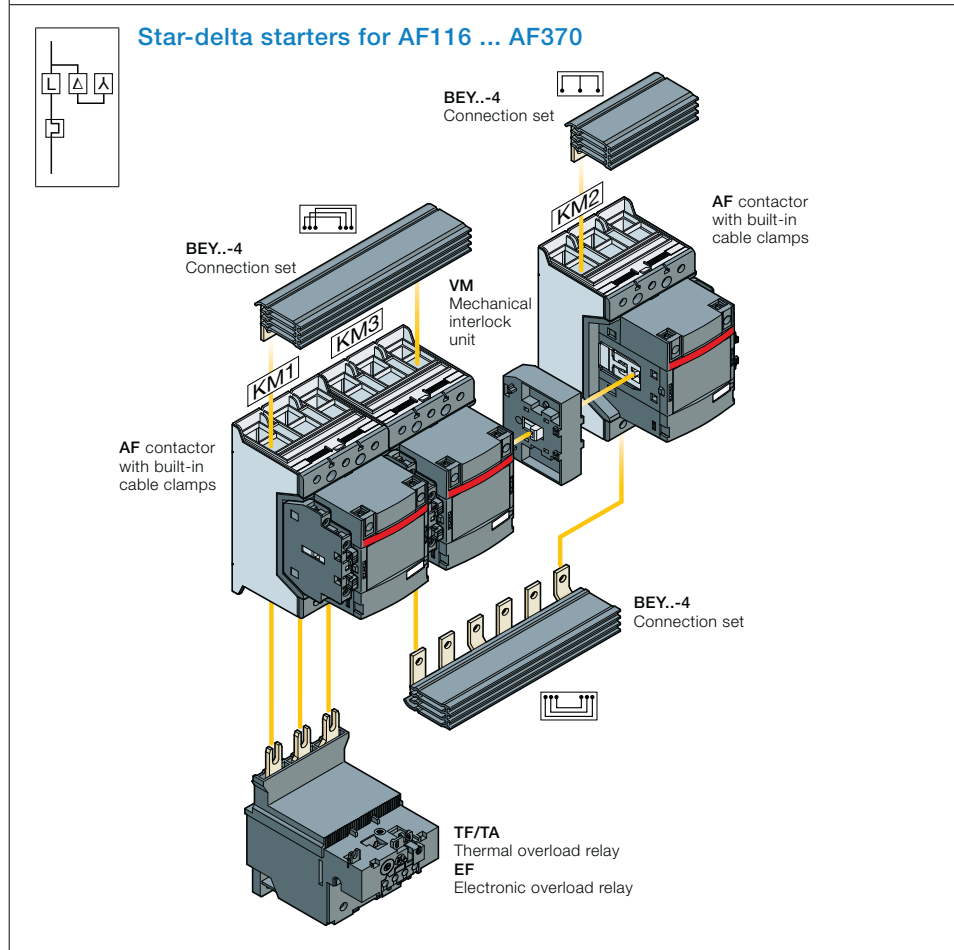

Star-delta starters protected by thermal overload relays With AF contactors - Open type version in kit form

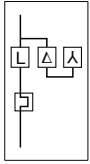

Line contactor KM1

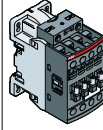

Delta contactor KM3

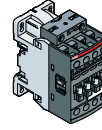

Star contactor KM2

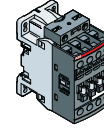

IEC AC-3 Rated power											Control voltage Uc min. ... Uc max. (1)		Type	Order code	Type	Order code	Type	Order code
220 V kW	230/240 V kW	380 V kW	400 V kW	415 V kW	440 V kW	500 V kW	690 V kW	400 V A	Rated current A	V 50/60 Hz	V DC							
4	4	7.5	7.5	7.5	7.5	9	9	15.5	24...60	20...60	24...60	20...60	AF09Z-30-10-21	1SBL136001R2110	AF09Z-30-10-21	1SBL136001R2110	AF09Z-30-10-21	1SBL136001R2110
									100...250	100...250	100...250	100...250	AF09-30-10-13	1SBL137001R1310	AF09-30-10-13	1SBL137001R1310	AF09-30-10-13	1SBL137001R1310
5.5	5.5	9	11	11	11	11	11	22	24...60	20...60	24...60	20...60	AF12Z-30-10-21	1SBL156001R2110	AF12Z-30-10-21	1SBL156001R2110	AF09Z-30-10-21	1SBL136001R2110
									100...250	100...250	100...250	100...250	AF12-30-10-13	1SBL157001R1310	AF12-30-10-13	1SBL157001R1310	AF09-30-10-13	1SBL137001R1310
7.5	9	15	15	15	15	15	15	29	24...60	20...60	24...60	20...60	AF16Z-30-10-21	1SBL176001R2110	AF16Z-30-10-21	1SBL176001R2110	AF09Z-30-10-21	1SBL136001R2110
									100...250	100...250	100...250	100...250	AF16-30-10-13	1SBL177001R1310	AF16-30-10-13	1SBL177001R1310	AF09-30-10-13	1SBL137001R1310
11	11	18.5	18.5	25	25	25	25	35	24...60	20...60	24...60	20...60	AF26Z-30-00-21	1SBL236001R2100	AF26Z-30-00-21	1SBL236001R2100	AF26Z-30-00-21	1SBL236001R2100
									100...250	100...250	100...250	100...250	AF26-30-00-13	1SBL237001R1300	AF26-30-00-13	1SBL237001R1300	AF26-30-00-13	1SBL237001R1300
11	11	22	22	25	25	25	25	41	24...60	20...60	24...60	20...60	AF26Z-30-00-21	1SBL236001R2100	AF26Z-30-00-21	1SBL236001R2100	AF26Z-30-00-21	1SBL236001R2100
									100...250	100...250	100...250	100...250	AF26-30-00-13	1SBL237001R1300	AF26-30-00-13	1SBL237001R1300	AF26-30-00-13	1SBL237001R1300
11	15	25	25	25	25	30	30	47	24...60	20...60	24...60	20...60	AF30Z-30-00-21	1SBL276001R2100	AF30Z-30-00-21	1SBL276001R2100	AF26Z-30-00-21	1SBL236001R2100
									100...250	100...250	100...250	100...250	AF30-30-00-13	1SBL277001R1300	AF30-30-00-13	1SBL277001R1300	AF26-30-00-13	1SBL237001R1300
18.5	18.5	37	37	37	37	37	37	66	24...60	20...60	24...60	20...60	AF40-30-00-11	1SBL347001R1100	AF40-30-00-11	1SBL347001R1100	AF40-30-00-11	1SBL347001R1100
									100...250	100...250	100...250	100...250	AF40-30-00-13	1SBL347001R1300	AF40-30-00-13	1SBL347001R1300	AF40-30-00-13	1SBL347001R1300
25	25	45	45	45	45	45	45	80	24...60	20...60	24...60	20...60	AF52-30-00-11	1SBL367001R1100	AF52-30-00-11	1SBL367001R1100	AF40-30-00-11	1SBL347001R1100
									100...250	100...250	100...250	100...250	AF52-30-00-13	1SBL367001R1300	AF52-30-00-13	1SBL367001R1300	AF40-30-00-13	1SBL347001R1300
30	30	55	55	55	55	55	55	97	24...60	20...60	24...60	20...60	AF65-30-00-11	1SBL387001R1100	AF65-30-00-11	1SBL387001R1100	AF40-30-00-11	1SBL347001R1100
									100...250	100...250	100...250	100...250	AF65-30-00-13	1SBL387001R1300	AF65-30-00-13	1SBL387001R1300	AF40-30-00-13	1SBL347001R1300
37	37	75	75	75	75	75	75	132	24...60	20...60	24...60	20...60	AF80-30-00-11	1SBL397001R1100	AF80-30-00-11	1SBL397001R1100	AF52-30-00-11	1SBL367001R1100
									100...250	100...250	100...250	100...250	AF80-30-00-13	1SBL397001R1300	AF80-30-00-13	1SBL397001R1300	AF52-30-00-13	1SBL367001R1300
45	45	90	90	90	90	90	90	160	24...60	20...60	24...60	20...60	AF96-30-00-11	1SBL407001R1100	AF96-30-00-11	1SBL407001R1100	AF65-30-00-11	1SBL387001R1100
									100...250	100...250	100...250	100...250	AF96-30-00-13	1SBL407001R1300	AF96-30-00-13	1SBL407001R1300	AF65-30-00-13	1SBL387001R1300
55	55	90	110	110	132	132	110	195	24...60	20...60	24...60	20...60	AF116-30-11-11	1SFL427001R1111	AF116-30-11-11	1SFL427001R1111	AF116-30-11-11 (4)	1SFL427001R1111
									100...250	100...250	100...250	100...250	AF116-30-11-13	1SFL427001R1311	AF116-30-11-13	1SFL427001R1311	AF116-30-11-13	1SFL427001R1311
75	75	132	132	132	132	160	132	230	24...60	20...60	24...60	20...60	AF140-30-11-11	1SFL447001R1111	AF140-30-11-11	1SFL447001R1111	AF116-30-11-11	1SFL427001R1111
									100...250	100...250	100...250	100...250	AF140-30-11-13	1SFL447001R1311	AF140-30-11-13	1SFL447001R1311	AF116-30-11-13	1SFL427001R1311
90	90	160	160	160	160	200	200	280	24...60	20...60	24...60	20...60	AF190-30-11-11	1SFL487002R1111	AF190-30-11-11	1SFL487002R1111	AF140-30-11-11	1SFL447001R1111
									100...250	100...250	100...250	100...250	AF190-30-11-13	1SFL487002R1311	AF190-30-11-13	1SFL487002R1311	AF140-30-11-13	1SFL447001R1311

(1) AF09 ... AF190: ambient temperature ≤ 60 °C.



(2) The setting current value is: nominal motor current x 0.58. Overload relay type given for 400 V - AC-3.

For other voltage, select overload relay type according to required nominal motor current x 0.58.

(3) On-delay timer without dwelling-time (e.g.: side-mounted CT-ERS.21S or front-mounted TEF4-ON) is enough to countdown the programmed starting time during "Star connection".

In case of use of front-mounted TEF4-ON on-delay timer, mount on KM1 contactor AF26 ... AF96 a side-mounted CAL4-11 auxiliary contact block instead of CA4-10 auxiliary contact block.

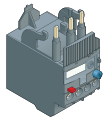
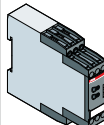
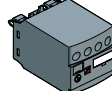
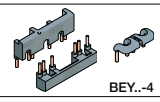
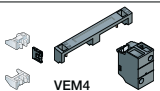
(4) AF80 can also be used, but no connection set and mechanical interlock is available for this combination.

Thermal overload relays (2)			Electronic timers (3)			Accessories			Auxiliary contact blocks		
			 CT-ERS  TEF4-ON Uc = 24...240 V 50/60 Hz or DC			 BEY..4  VEM4			 CA4		
Setting ranges	Type	Order code	Type	Order code	Type	Order code	Type	Order code	Type	Order code	
A											
7.60...10.0	TF42-10	1SAZ721201R1043	CT-ERS.21S or TEF4-ON	1SVR730100R0300 1SBN020112R1000	BEY16-4 + VEM4	1SBN081313R2000 1SBN030111R1000	-	-	-	-	
10.0...13.0	TF42-13	1SAZ721201R1045	CT-ERS.21S or TEF4-ON	1SVR730100R0300 1SBN020112R1000	BEY16-4 + VEM4	1SBN081313R2000 1SBN030111R1000	-	-	-	-	
16.0...20.0	TF42-20	1SAZ721201R1049	CT-ERS.21S or TEF4-ON	1SVR730100R0300 1SBN020112R1000	BEY16-4 + VEM4	1SBN081313R2000 1SBN030111R1000	-	-	-	-	
20.0...24.0	TF42-24	1SAZ721201R1051	CT-ERS.21S or TEF4-ON	1SVR730100R0300 1SBN020112R1000	BEY38-4 + VEM4	1SBN082713R2000 1SBN030111R1000	KM1 : 1 x CA4-10 KM2 : 1 x CA4-10	1SBN010110R1010 1SBN010110R1010			
20.0...24.0	TF42-24	1SAZ721201R1051	CT-ERS.21S or TEF4-ON	1SVR730100R0300 1SBN020112R1000	BEY38-4 + VEM4	1SBN082713R2000 1SBN030111R1000	KM1 : 1 x CA4-10 KM2 : 1 x CA4-10	1SBN010110R1010 1SBN010110R1010			
24.0...29.0	TF42-29	1SAZ721201R1052	CT-ERS.21S or TEF4-ON	1SVR730100R0300 1SBN020112R1000	BEY38-4 + VEM4	1SBN082713R2000 1SBN030111R1000	KM1 : 1 x CA4-10 KM2 : 1 x CA4-10	1SBN010110R1010 1SBN010110R1010			
30.0...40.0	TF65-40	1SAZ811201R1003	CT-ERS.21S or TEF4-ON	1SVR730100R0300 1SBN020112R1000	BEY65-4 + VM96-4	1SBN083413R2000 1SBN033405T1000	KM1 : 1 x CA4-10 (3) KM2 : 1 x CA4-10 1 x CA4-01 KM3 : 1 x CA4-01	1SBN010110R1010 1SBN010110R1010 1SBN010110R1001 1SBN010110R1001			
36.0...47.0	TF65-47	1SAZ811201R1004	CT-ERS.21S or TEF4-ON	1SVR730100R0300 1SBN020112R1000	BEY65-4 + VM96-4	1SBN083413R2000 1SBN033405T1000	KM1 : 1 x CA4-10 (3) KM2 : 1 x CA4-10 1 x CA4-01 KM3 : 1 x CA4-01	1SBN010110R1010 1SBN010110R1010 1SBN010110R1001 1SBN010110R1001			
50.0...60.0	TF65-60	1SAZ811201R1006	CT-ERS.21S or TEF4-ON	1SVR730100R0300 1SBN020112R1000	BEY65-4 + VM96-4	1SBN083413R2000 1SBN033405T1000	KM1 : 1 x CA4-10 (3) KM2 : 1 x CA4-10 1 x CA4-01 KM3 : 1 x CA4-01	1SBN010110R1010 1SBN010110R1010 1SBN010110R1001 1SBN010110R1001			
65.0...78.0	TF96-78	1SAZ911201R1004	CT-ERS.21S or TEF4-ON	1SVR730100R0300 1SBN020112R1000	BEY96-4 + VM96-4	1SBN083913R2000 1SBN033405T1000	KM1 : 1 x CA4-10 (3) KM2 : 1 x CA4-10 1 x CA4-01 KM3 : 1 x CA4-01	1SBN010110R1010 1SBN010110R1010 1SBN010110R1001 1SBN010110R1001			
84.0...96.0	TF96-96	1SAZ911201R1006	CT-ERS.21S or TEF4-ON	1SVR730100R0300 1SBN020112R1000	BEY96-4 + VM96-4	1SBN083913R2000 1SBN033405T1000	KM1 : 1 x CA4-10 (3) KM2 : 1 x CA4-10 1 x CA4-01 KM3 : 1 x CA4-01	1SBN010110R1010 1SBN010110R1010 1SBN010110R1001 1SBN010110R1001			
100...135	TF140DU-135	1SAZ431201R1003	CT-ERS.21S	1SVR730100R0300	BEY140-4 + VM19	1SFN084413R1000 1SFN030300R1000	-	-	-	-	
100...135	TF140DU-135	1SAZ431201R1003	CT-ERS.21S	1SVR730100R0300	BEY140-4 + VM19	1SFN084413R1000 1SFN030300R1000	-	-	-	-	
130...175	TA200DU-175	1SAZ421201R1005	CT-ERS.21S	1SVR730100R0300	BEY190-4 + VM140/190	1SFN084813R1000 1SFN034403R1000	-	-	-	-	

Star-delta starters protected by electronic overload relays With AF contactors - Open type version in kit form

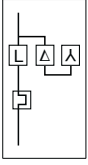

Line contactor KM1

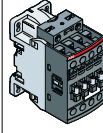

Delta contactor KM3

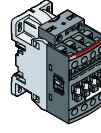

Star contactor KM2

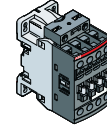

IEC AC-3 Rated power											Control voltage Uc min. ... Uc max. (1)		Type	Order code	Type	Order code	Type	Order code	
220 V kW	230/240 V kW	380 V kW	400 V kW	415 V kW	440 V kW	500 V kW	690 V kW	400 V A	Rated current A	V 50/60 Hz	V DC								
4	4	7.5	7.5	7.5	7.5	9	9	15.5		24...60 100...250	20...60 100...250	AF09Z-30-10-21	1SBL136001R2110	AF09-30-10-13	1SBL137001R1310	AF09Z-30-10-21	1SBL136001R2110	AF09-30-10-13	1SBL137001R1310
5.5	5.5	9	11	11	11	11	11	22		24...60 100...250	20...60 100...250	AF12Z-30-10-21	1SBL156001R2110	AF12-30-10-13	1SBL157001R1310	AF12Z-30-10-21	1SBL156001R2110	AF12-30-10-13	1SBL157001R1310
7.5	9	15	15	15	15	15	15	29		24...60 100...250	20...60 100...250	AF16Z-30-10-21	1SBL176001R2110	AF16-30-10-13	1SBL177001R1310	AF16Z-30-10-21	1SBL176001R2110	AF16-30-10-13	1SBL177001R1310
11	11	18.5	18.5	25	25	25	25	35		24...60 100...250	20...60 100...250	AF26Z-30-00-21	1SBL236001R2100	AF26-30-00-13	1SBL237001R1300	AF26Z-30-00-21	1SBL236001R2100	AF26-30-00-13	1SBL237001R1300
11	11	22	22	25	25	25	25	41		24...60 100...250	20...60 100...250	AF26Z-30-00-21	1SBL236001R2100	AF26-30-00-13	1SBL237001R1300	AF26Z-30-00-21	1SBL236001R2100	AF26-30-00-13	1SBL237001R1300
11	15	25	25	25	25	30	30	47		24...60 100...250	20...60 100...250	AF30Z-30-00-21	1SBL276001R2100	AF30-30-00-13	1SBL277001R1300	AF30Z-30-00-21	1SBL276001R2100	AF30-30-00-13	1SBL277001R1300
18.5	18.5	37	37	37	37	37	37	66		24...60 100...250	20...60 100...250	AF40-30-00-11	1SBL347001R1100	AF40-30-00-13	1SBL347001R1300	AF40-30-00-11	1SBL347001R1100	AF40-30-00-13	1SBL347001R1300
25	25	45	45	45	45	45	45	80		24...60 100...250	20...60 100...250	AF52-30-00-11	1SBL367001R1100	AF52-30-00-13	1SBL367001R1300	AF52-30-00-11	1SBL367001R1100	AF52-30-00-13	1SBL367001R1300
30	30	55	55	55	55	55	55	97		24...60 100...250	20...60 100...250	AF65-30-00-11	1SBL387001R1100	AF65-30-00-13	1SBL387001R1300	AF65-30-00-11	1SBL387001R1100	AF65-30-00-13	1SBL387001R1300
37	37	75	75	75	75	75	75	132		24...60 100...250	20...60 100...250	AF80-30-00-11	1SBL397001R1100	AF80-30-00-13	1SBL397001R1300	AF80-30-00-11	1SBL397001R1100	AF80-30-00-13	1SBL397001R1300
45	45	90	90	90	90	90	90	160		24...60 100...250	20...60 100...250	AF96-30-00-11	1SBL407001R1100	AF96-30-00-13	1SBL407001R1300	AF96-30-00-11	1SBL407001R1100	AF96-30-00-13	1SBL407001R1300
55	55	90	110	110	132	132	110	195		24...60 100...250	20...60 100...250	AF116-30-11-11	1SFL427001R1111	AF116-30-11-13	1SFL427001R1311	AF116-30-11-11 (4)	1SFL427001R1111	AF116-30-11-13	1SFL427001R1311
75	75	132	132	132	132	160	132	230		24...60 100...250	20...60 100...250	AF140-30-11-11	1SFL447001R1111	AF140-30-11-13	1SFL447001R1311	AF140-30-11-11	1SFL447001R1111	AF140-30-11-13	1SFL447001R1311
90	90	160	160	160	160	200	200	280		24...60 100...250	20...60 100...250	AF190-30-11-11	1SFL487002R1111	AF190-30-11-13	1SFL487002R1311	AF190-30-11-11	1SFL487002R1111	AF190-30-11-13	1SFL487002R1311
110	110	160	200	200	200	250	250	350		24...60 100...250	20...60 100...250	AF205-30-11-11	1SFL527002R1111	AF205-30-11-13	1SFL527002R1311	AF205-30-11-11	1SFL527002R1111	AF205-30-11-13	1SFL527002R1311
132	132	250	250	250	250	315	355	430		24...60 100...250	20...60 100...250	AF265-30-11-11	1SFL547002R1111	AF265-30-11-13	1SFL547002R1311	AF265-30-11-11	1SFL547002R1111	AF265-30-11-13	1SFL547002R1311
160	160	315	315	315	355	400	400	540		24...60 100...250	20...60 100...250	AF370-30-11-11	1SFL607002R1111	AF370-30-11-13	1SFL607002R1311	AF370-30-11-11	1SFL607002R1111	AF370-30-11-13	1SFL607002R1311
200	200	315	355	355	400	400	500	610		24...60 100...250	20...60 100...250	AF370-30-11-11	1SFL607002R1111	AF370-30-11-13	1SFL607002R1311	AF370-30-11-11	1SFL607002R1111	AF370-30-11-13	1SFL607002R1311

(1) AF09 ... AF370: ambient temperature ≤ 60 °C.



(2) The setting current value is: nominal motor current x 0.58. Overload relay type given for 400 V - AC-3.

For other voltage, select overload relay type according to required nominal motor current x 0.58.

(3) On-delay timer without dwelling-time (e.g.: side-mounted CT-ERS.21S or front-mounted TEF4-ON) is enough to countdown the programmed starting time during "Star connection".

In case of use of front-mounted TEF4-ON on-delay timer, mount on KM1 contactor AF26 ... AF96 a side-mounted CAL4-11 auxiliary contact block instead of CA4-10 auxiliary contact block.

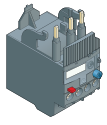
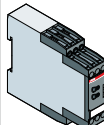
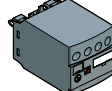
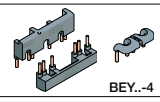
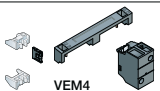
(4) AF80 can also be used, but no connection set and mechanical interlock is available for this combination.

Electronic overload relays (2)			Electronic timers (3)			Accessories			Auxiliary contact blocks		
			 CT-ERS  TEF4-ON Uc = 24...240 V 50/60 Hz or DC			 BEY..-4  VEM4			 CA4		
Setting ranges	Type	Order code	Type	Order code	Type	Order code	Type	Order code			
A											
5.70...18.9	EF19-18.9	1SAX121001R1105	CT-ERS.21S or TEF4-ON	1SVR730100R0300 1SBN020112R1000	BEY16-4 + VEM4	1SBN081313R2000 1SBN030111R1000	-	-			
5.70...18.9	EF19-18.9	1SAX121001R1105	CT-ERS.21S or TEF4-ON	1SVR730100R0300 1SBN020112R1000	BEY16-4 + VEM4	1SBN081313R2000 1SBN030111R1000	-	-			
5.70...18.9	EF19-18.9	1SAX121001R1105	CT-ERS.21S or TEF4-ON	1SVR730100R0300 1SBN020112R1000	BEY16-4 + VEM4	1SBN081313R2000 1SBN030111R1000	-	-			
9.00...30.0	EF45-30	1SAX221001R1101	CT-ERS.21S or TEF4-ON	1SVR730100R0300 1SBN020112R1000	BEY38-4 + VEM4	1SBN082713R2000 1SBN030111R1000	KM1 : 1 x CA4-10 KM2 : 1 x CA4-10	1SBN010110R1010 1SBN010110R1010			
9.00...30.0	EF45-30	1SAX221001R1101	CT-ERS.21S or TEF4-ON	1SVR730100R0300 1SBN020112R1000	BEY38-4 + VEM4	1SBN082713R2000 1SBN030111R1000	KM1 : 1 x CA4-10 KM2 : 1 x CA4-10	1SBN010110R1010 1SBN010110R1010			
9.00...30.0	EF45-30	1SAX221001R1101	CT-ERS.21S or TEF4-ON	1SVR730100R0300 1SBN020112R1000	BEY38-4 + VEM4	1SBN082713R2000 1SBN030111R1000	KM1 : 1 x CA4-10 KM2 : 1 x CA4-10	1SBN010110R1010 1SBN010110R1010			
25...70	EF65-70	1SAX331001R1101	CT-ERS.21S or TEF4-ON	1SVR730100R0300 1SBN020112R1000	BEY65-4 + VM96-4	1SBN083413R2000 1SBN033405T1000	KM1 : 1 x CA4-10 (3) KM2 : 1 x CA4-10 1 x CA4-01 KM3 : 1 x CA4-01	1SBN010110R1010 1SBN010110R1010 1SBN010110R1001 1SBN010110R1001			
25...70	EF65-70	1SAX331001R1101	CT-ERS.21S or TEF4-ON	1SVR730100R0300 1SBN020112R1000	BEY65-4 + VM96-4	1SBN083413R2000 1SBN033405T1000	KM1 : 1 x CA4-10 (3) KM2 : 1 x CA4-10 1 x CA4-01 KM3 : 1 x CA4-01	1SBN010110R1010 1SBN010110R1010 1SBN010110R1001 1SBN010110R1001			
25...70	EF65-70	1SAX331001R1101	CT-ERS.21S or TEF4-ON	1SVR730100R0300 1SBN020112R1000	BEY65-4 + VM96-4	1SBN083413R2000 1SBN033405T1000	KM1 : 1 x CA4-10 (3) KM2 : 1 x CA4-10 1 x CA4-01 KM3 : 1 x CA4-01	1SBN010110R1010 1SBN010110R1010 1SBN010110R1001 1SBN010110R1001			
36...100	EF96-100	1SAX341001R1101	CT-ERS.21S or TEF4-ON	1SVR730100R0300 1SBN020112R1000	BEY96-4 + VM96-4	1SBN083913R2000 1SBN033405T1000	KM1 : 1 x CA4-10 (3) KM2 : 1 x CA4-10 1 x CA4-01 KM3 : 1 x CA4-01	1SBN010110R1010 1SBN010110R1010 1SBN010110R1001 1SBN010110R1001			
36...100	EF96-100	1SAX341001R1101	CT-ERS.21S or TEF4-ON	1SVR730100R0300 1SBN020112R1000	BEY96-4 + VM96-4	1SBN083913R2000 1SBN033405T1000	KM1 : 1 x CA4-10 (3) KM2 : 1 x CA4-10 1 x CA4-01 KM3 : 1 x CA4-01	1SBN010110R1010 1SBN010110R1010 1SBN010110R1001 1SBN010110R1001			
54...150	EF146-150	1SAX351001R1101	CT-ERS.21S	1SVR730100R0300	BEY140-4 + VM19	1SFN084413R1000 1SFN030300R1000	-	-			
54...150	EF146-150	1SAX351001R1101	CT-ERS.21S	1SVR730100R0300	BEY140-4 + VM19	1SFN084413R1000 1SFN030300R1000	-	-			
63...210	EF205-210	1SAX531001R1101	CT-ERS.21S	1SVR730100R0300	BEY190-4 + VM140/190	1SFN084813R1000 1SFN034403R1000	-	-			
63...210	EF205-210	1SAX531001R1101	CT-ERS.21S	1SVR730100R0300	BEY205-4 + VM19	1SFN085213R1000 1SFN030300R1000	-	-			
115...380	EF370-380	1SAX611001R1101	CT-ERS.21S	1SVR730100R0300	BEY265-4 + VM205/265	1SFN085413R1000 1SFN035203R1000	-	-			
115...380	EF370-380	1SAX611001R1101	CT-ERS.21S	1SVR730100R0300	BEY370-4 + VM19	1SFN085813R1000 1SFN030300R1000	-	-			
115...380	EF370-380	1SAX611001R1101	CT-ERS.21S	1SVR730100R0300	BEY370-4 + VM19	1SFN085813R1000 1SFN030300R1000	-	-			

Star-delta starters protected by overload relays With AF contactors - Open type version in kit form Switching frequency diagrams

General

Switching frequency/hour, according to acceleration time and load factor. Respect of the following conditions enables utilization of the starter without excessive overheating of the connections or nuisance tripping of the thermal overload relay.

Thermal overload relay

Intermittent periodic duty

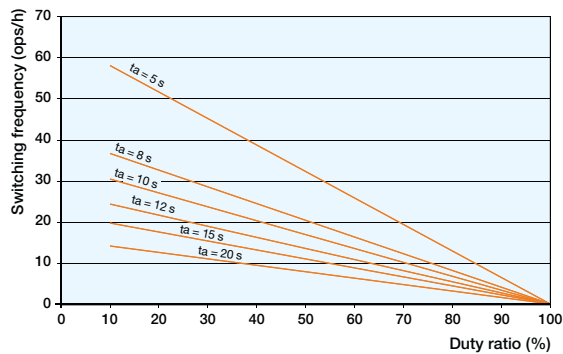

ta: motor starting time

Example:

Starting time of the motor: 7 second (use 8s curve) - Duty ratio: 63 % means a permitted switching frequency of max. 15 operating cycles per hour.

This corresponds to a 4 minute operating cycle (15 starts/hr) with 7 seconds acceleration, 2.5 minutes operation and 1.5 minutes rest.

Electronic overload relay : please consult us

Star-delta starters protected by overload relays

With AF contactors - Open type version in kit form

Wiring diagrams with CT-ERS.21S timer

Star-delta starters

Power circuit

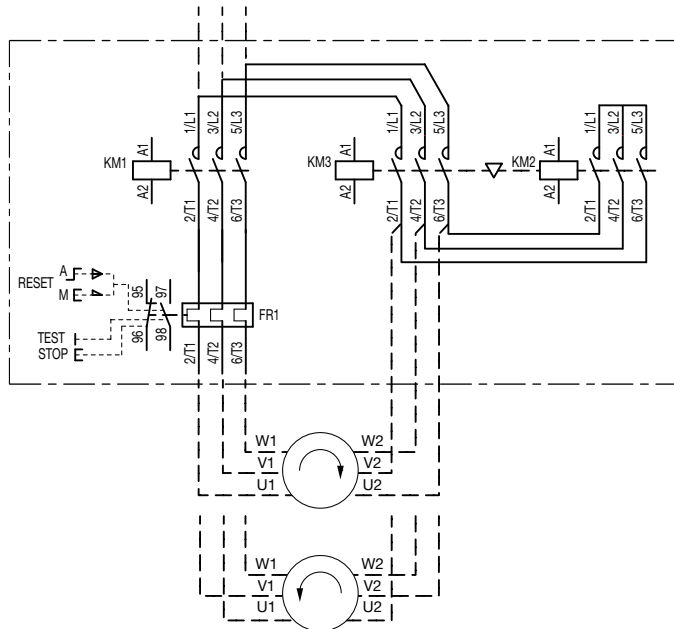

AC or DC local control with CT-ERS.21S timer

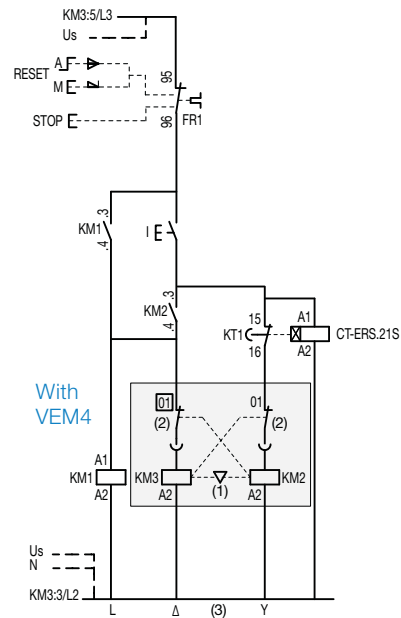

With VM

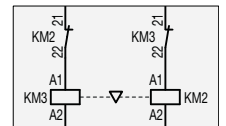

5

AC or DC remote control with CT-ERS.21S timer

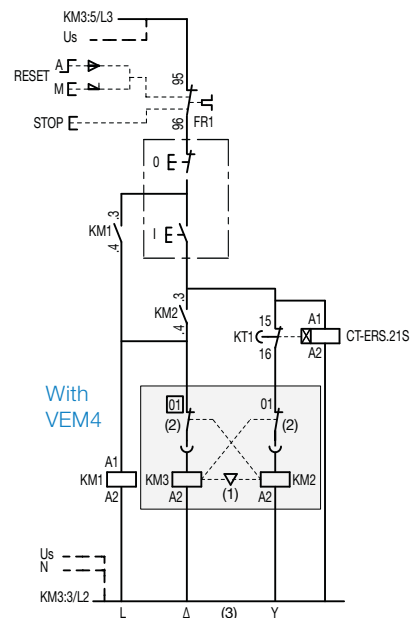

With VM

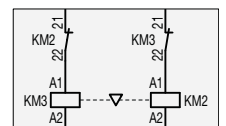

Note: - VEM4 = VM4 (1) + VE4 (2) with A2-A2 (3) connection
 (Except for coil Uc 12-20 V DC : use VM4 with CA4).
 - coil Uc 12-20 V DC : A1+, A2-

Star-delta starters protected by overload relays With AF contactors - Open type version in kit form Wiring diagrams with TEF4-ON timer

Star-delta starters

Power circuit

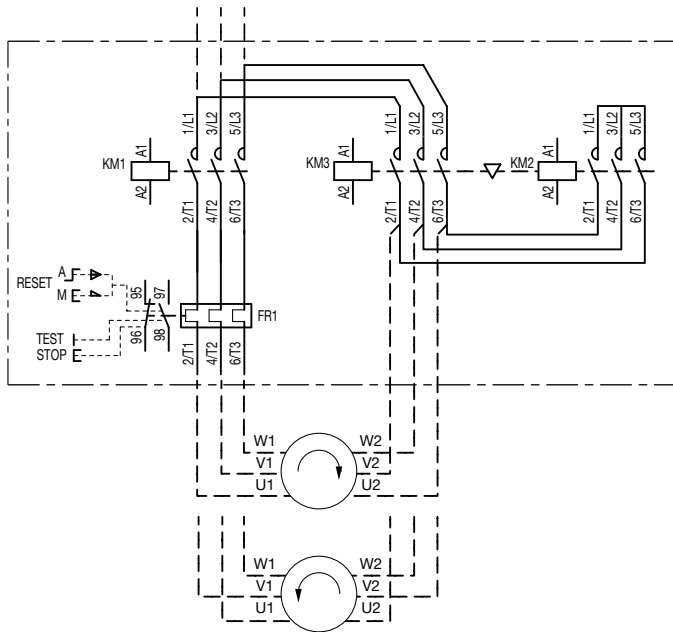

5

AC or DC local control with TEF4-ON timer

Uc = 24...240 V 50/60 Hz or DC

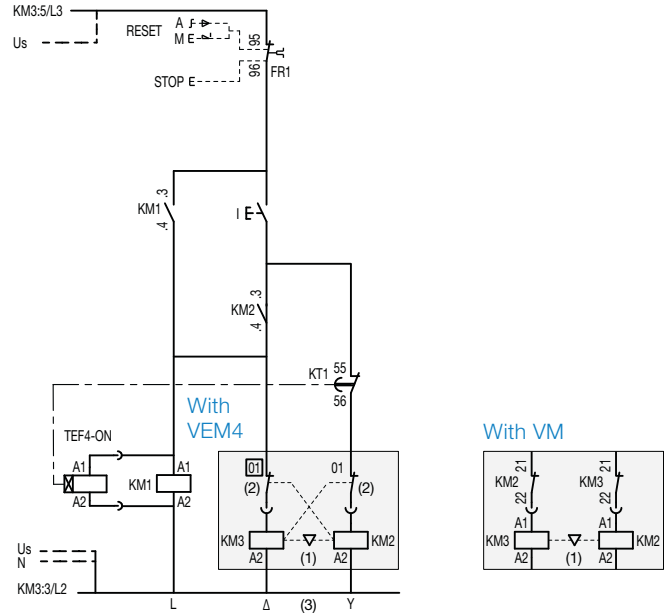

AC or DC remote control with TEF4-ON timer

Uc = 24...240 V 50/60 Hz or DC

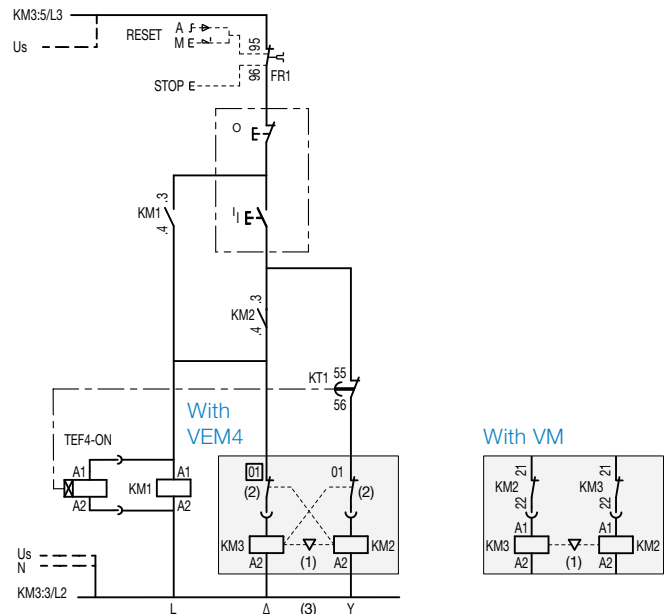

Note: VEM4 = VM4 (1) + VE4 (2) with A2-A2 (3) connection

Star-delta starters protected by thermal overload relays With AF contactors - Open type version in kit form

Main dimensions mm, inches

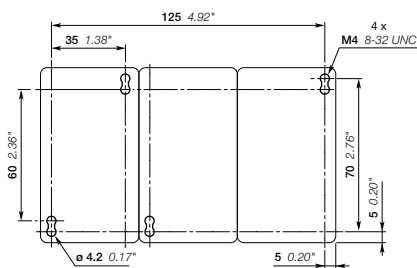
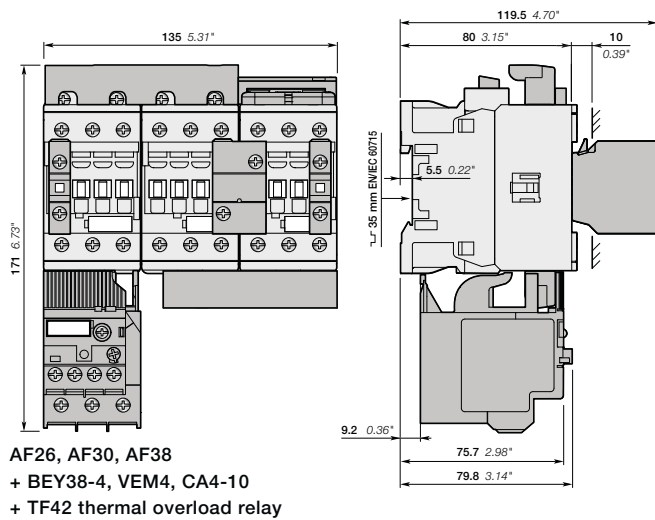
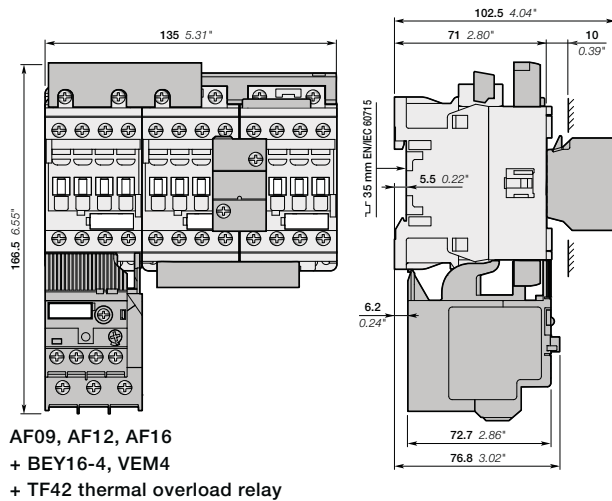

Note: contactor lateral distance to grounded component 2 mm 0.08" min.

Star-delta starters protected by thermal overload relays With AF contactors - Open type version in kit form

Main dimensions mm, inches

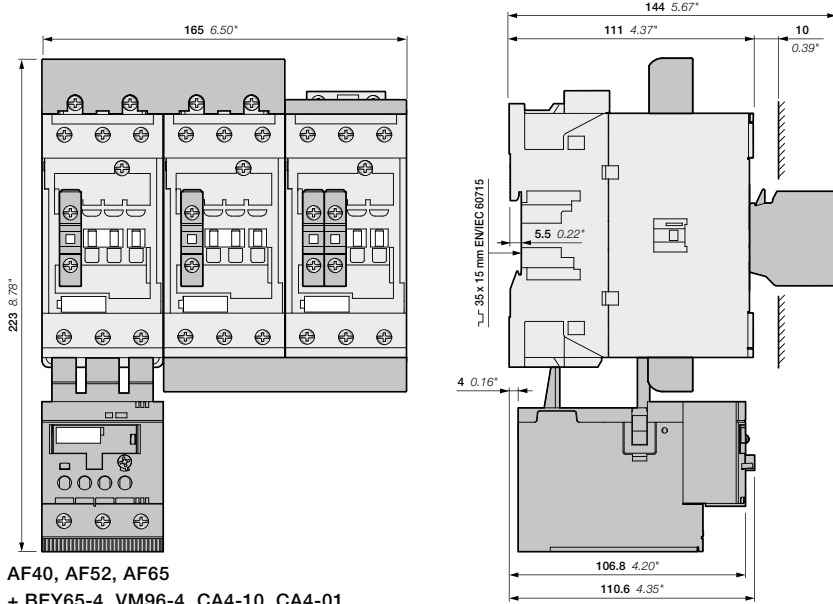

AF40, AF52, AF65
+ BEY65-4, VM96-4, CA4-10, CA4-01
+ TF65 thermal overload relay

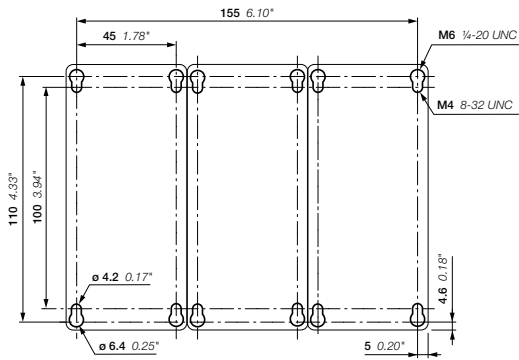

Star-delta starters protected by thermal overload relays With AF contactors - Open type version in kit form

Main dimensions mm, inches

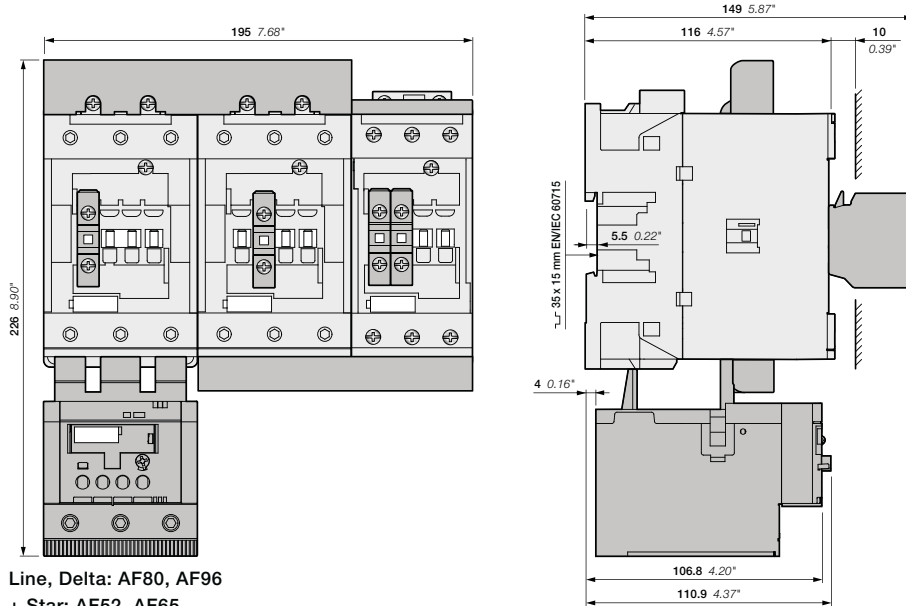

- Line, Delta: AF80, AF96
- + Star: AF52, AF65
- + BEY96-4, VM96-4, CA4-10, CA4-01
- + TF96 thermal overload relay

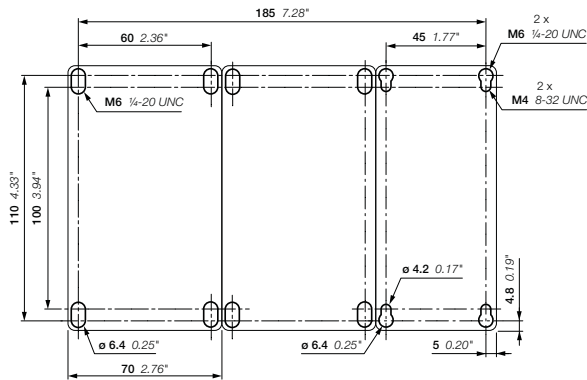

Star-delta starters protected by thermal overload relays With AF contactors - Open type version in kit form

Main dimensions mm, inches

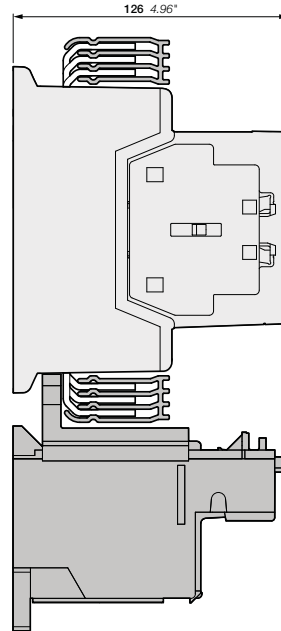
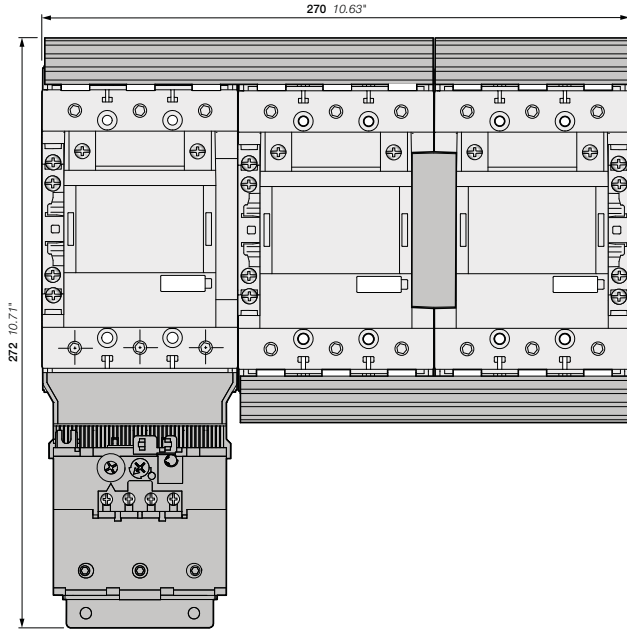

AF116, AF140, AF146
+ BEY140-4, VM19
+ TF140 thermal overload relay

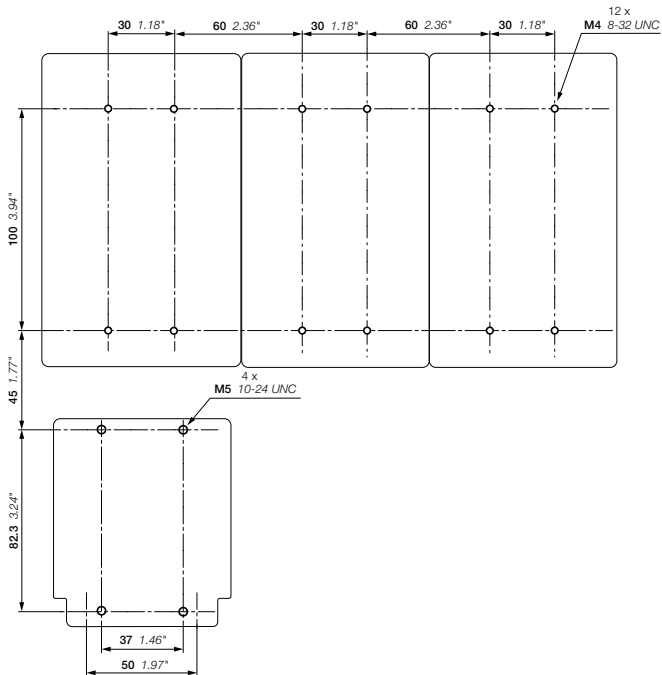

Star-delta starters protected by thermal overload relays With AF contactors - Open type version in kit form

Main dimensions mm, inches

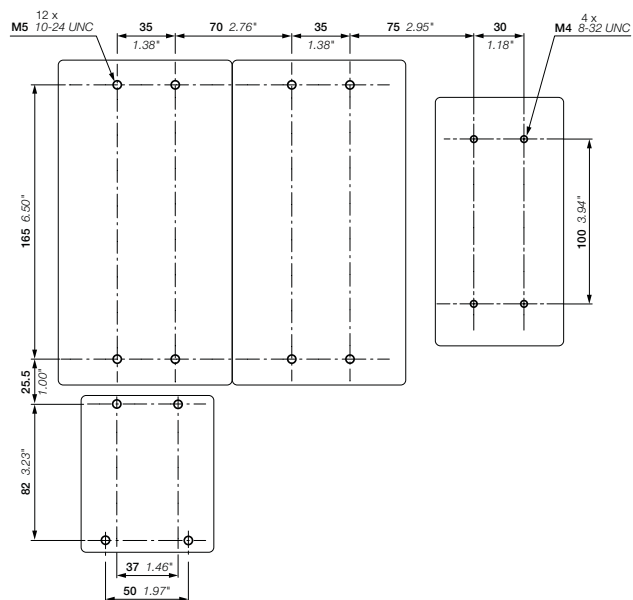
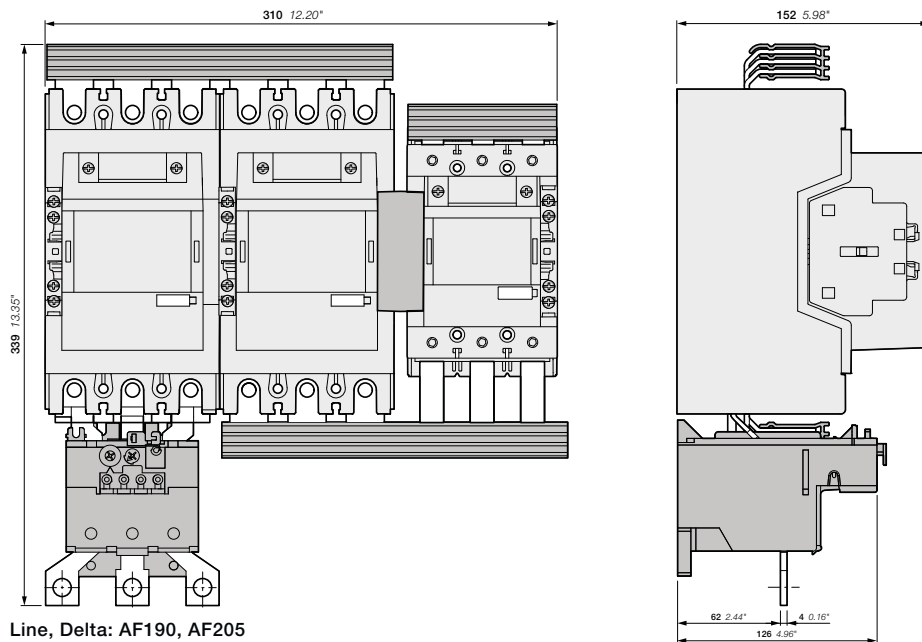

Star-delta starters protected by electronic overload relays With AF contactors - Open type version in kit form

Main dimensions mm, inches

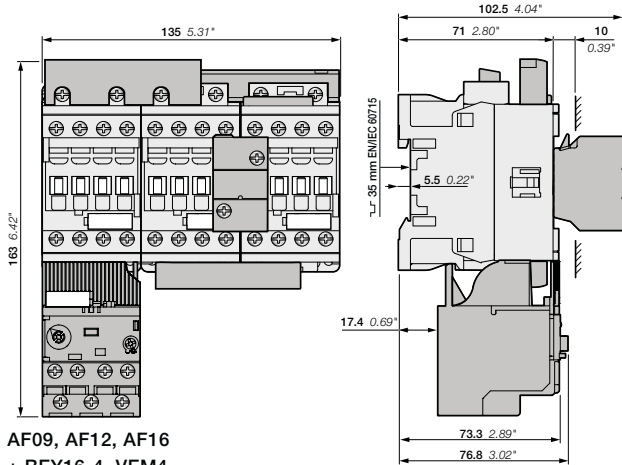

AF09, AF12, AF16
+ BEY16-4, VEM4
+ EF19 electronic overload relay

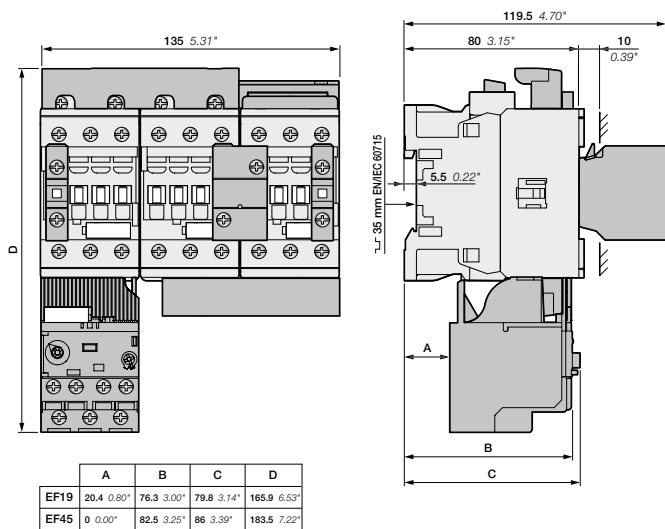

AF26, AF30, AF38
+ BEY38-4, VEM4, CA4-10
+ EF19/EF45 electronic overload relay

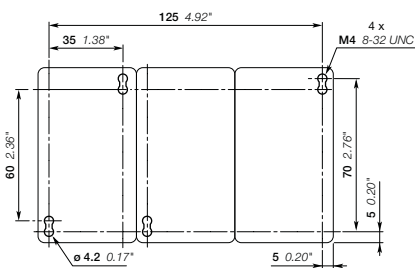

Note: contactor lateral distance to grounded component 2 mm 0.08" min.

Star-delta starters protected by electronic overload relays With AF contactors - Open type version in kit form

Main dimensions mm, inches

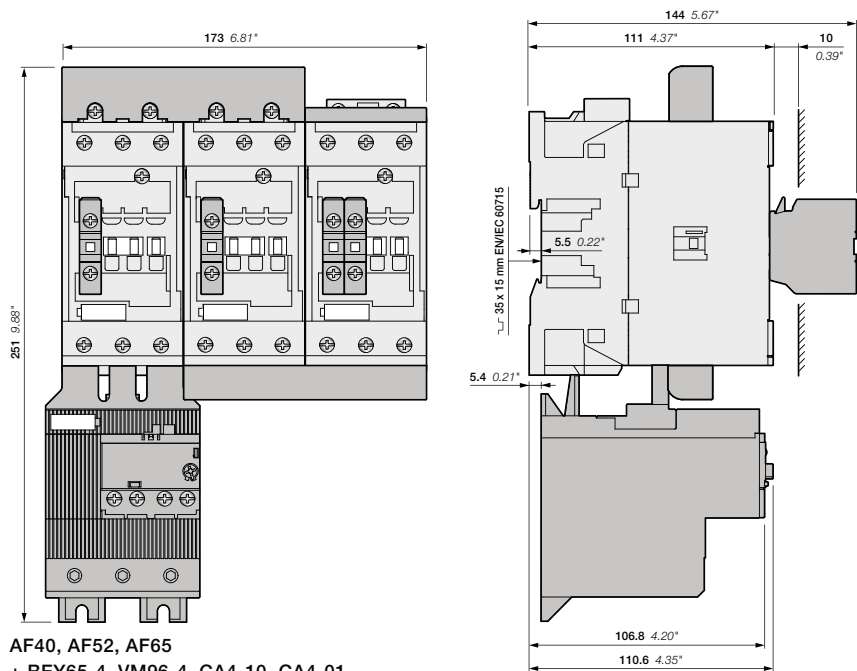

AF40, AF52, AF65
+ BEY65-4, VM96-4, CA4-10, CA4-01
+ EF65 electronic overload relay

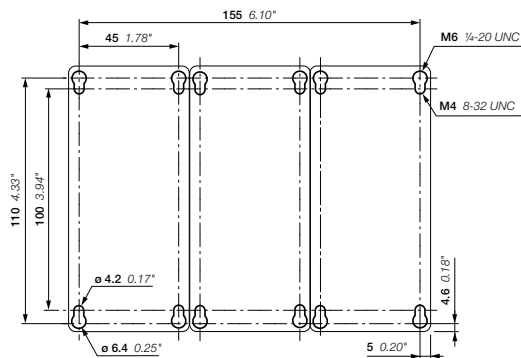

Star-delta starters protected by electronic overload relays With AF contactors - Open type version in kit form

Main dimensions mm, inches

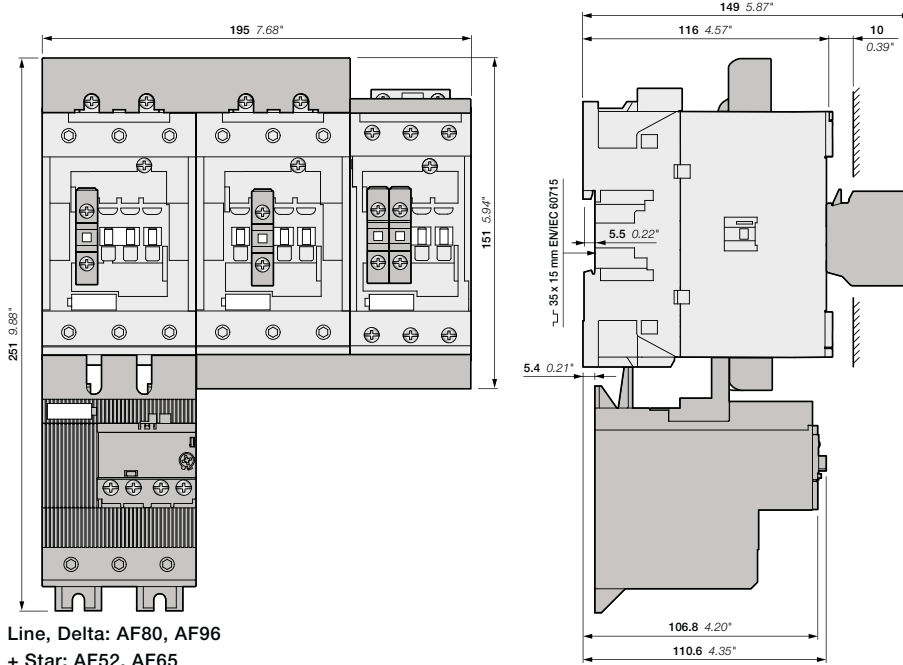

- Line, Delta: AF80, AF96
 + Star: AF52, AF65
 + BEY96-4, VM96-4, CA4-10, CA4-01
 + EF96 electronic overload relay

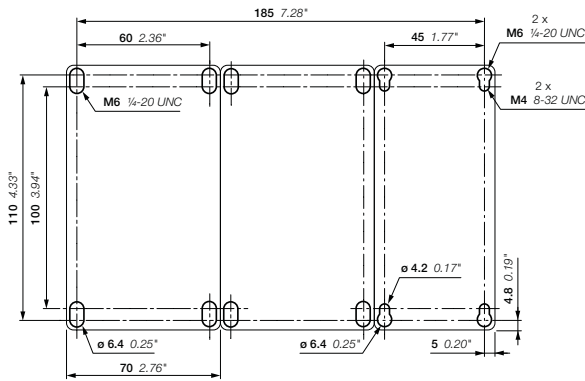

Star-delta starters protected by electronic overload relays With AF contactors - Open type version in kit form

Main dimensions mm, inches

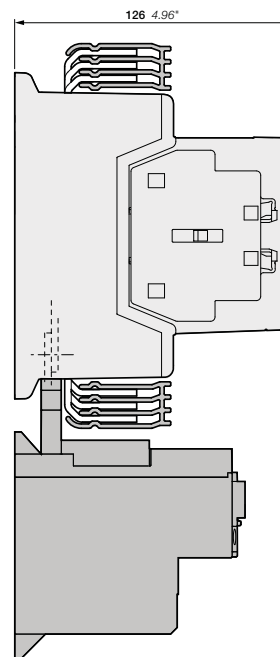
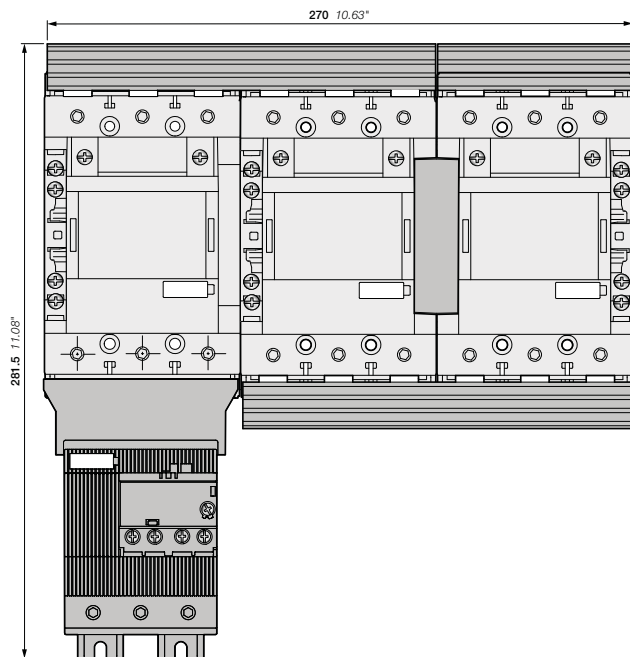

- AF116, AF140, AF146
- + BEY140-4, VM19
- + EF146 electronic overload relay

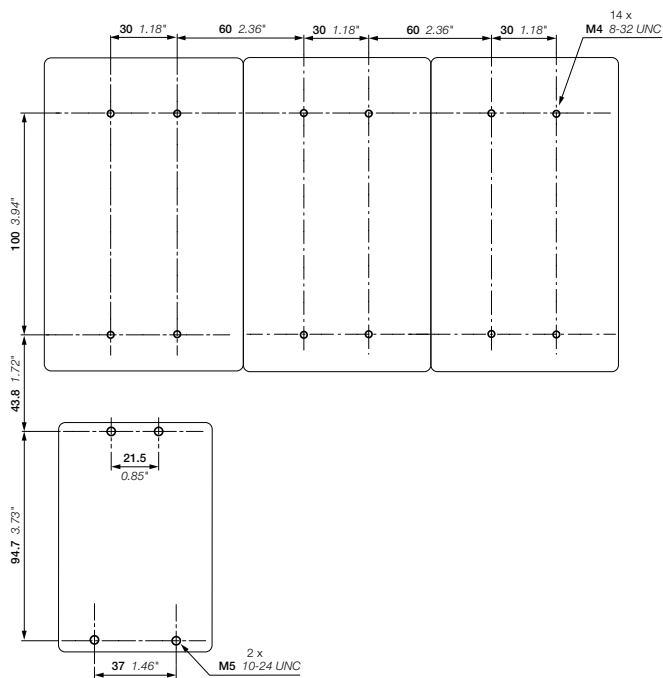

Star-delta starters protected by electronic overload relays With AF contactors - Open type version in kit form

Main dimensions mm, inches

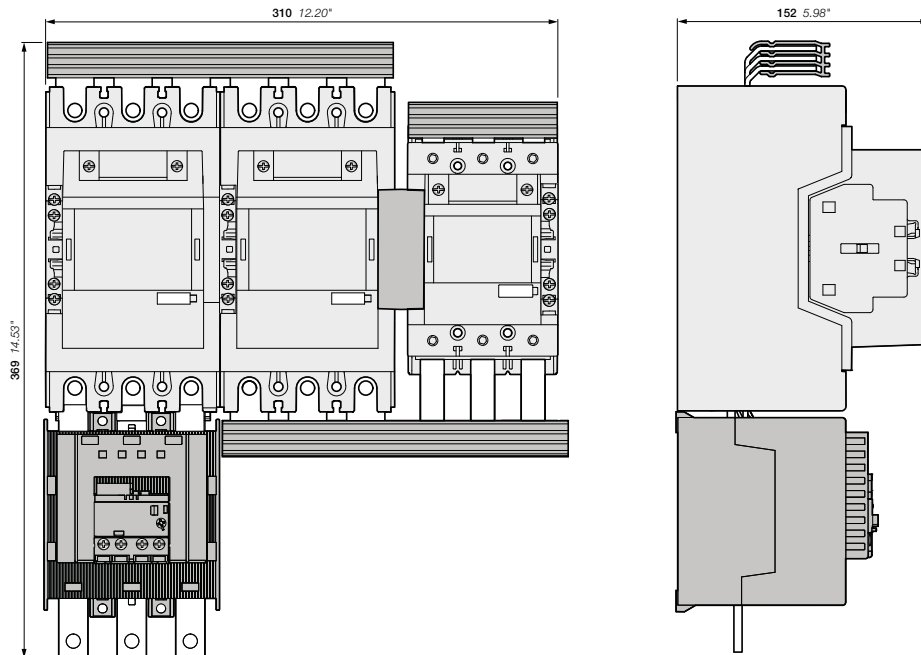

5

- Line, Delta: AF190, AF205
- + Star: AF116, AF140, AF146
- + BEY190-4, VM140/190
- + EF205 electronic overload relay

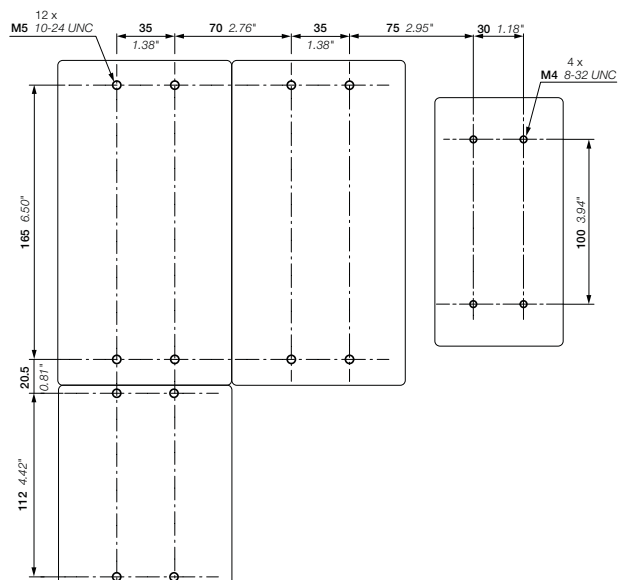

Star-delta starters protected by electronic overload relays With AF contactors - Open type version in kit form

Main dimensions mm, inches

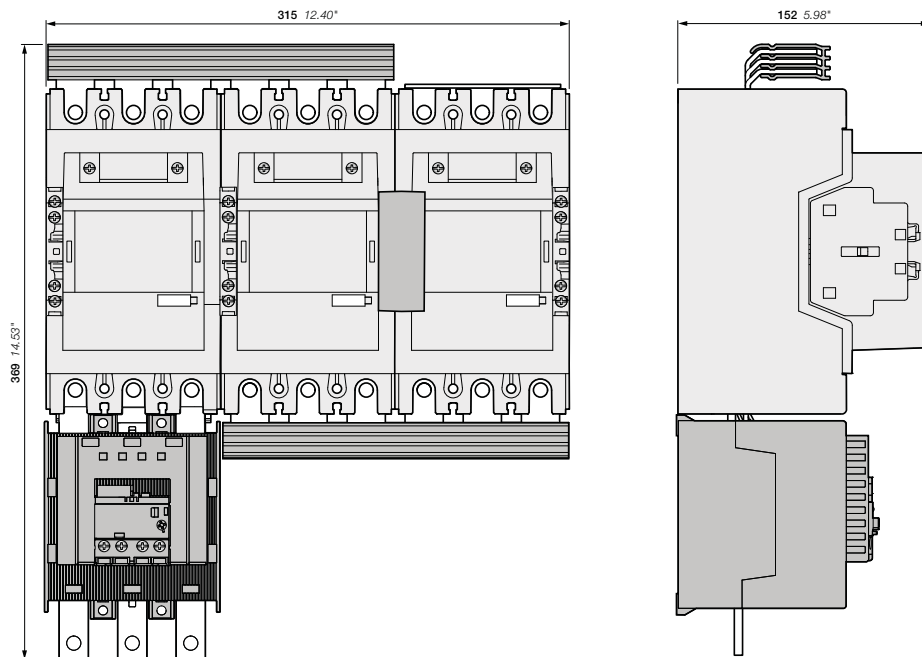

- AF190, AF205
- + BEY205-4, VM19
- + EF205 electronic overload relay

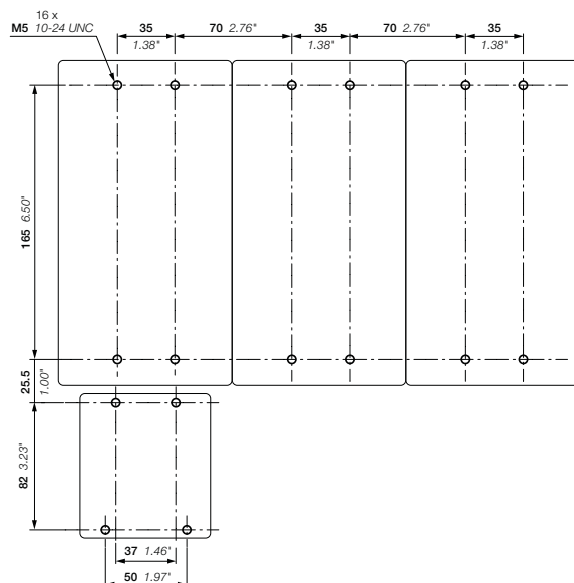

Star-delta starters protected by electronic overload relays With AF contactors - Open type version in kit form

Main dimensions mm, inches

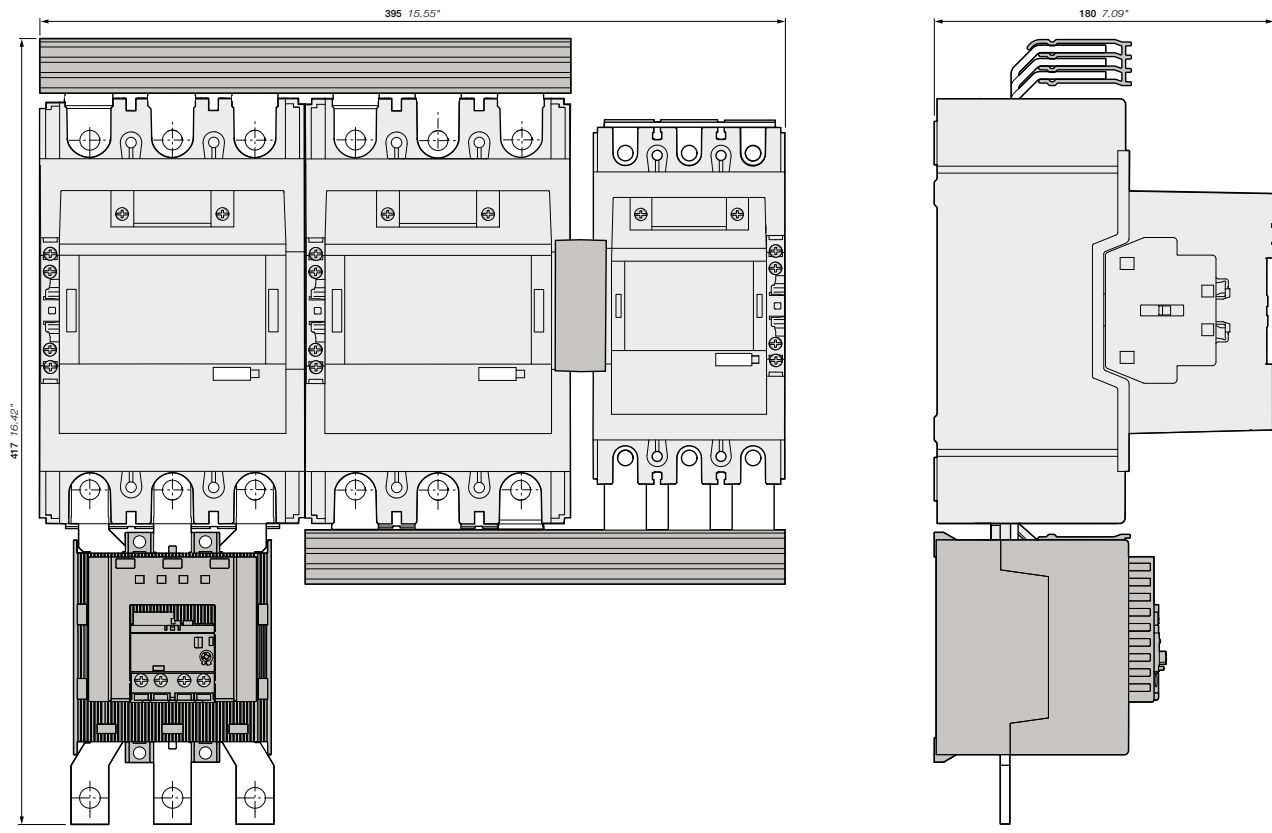

5

- Line, Delta: AF265, AF305, AF370
- + Star: AF190, AF205
- + BEY265-4, VM205/265
- + EF370 electronic overload relay

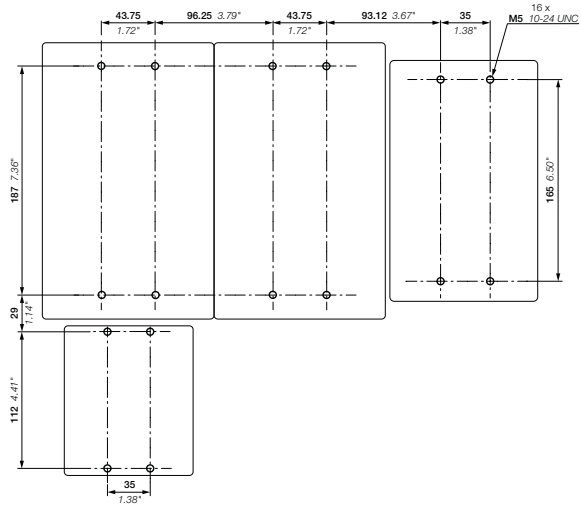

Star-delta starters protected by electronic overload relays With AF contactors - Open type version in kit form

Main dimensions mm, inches

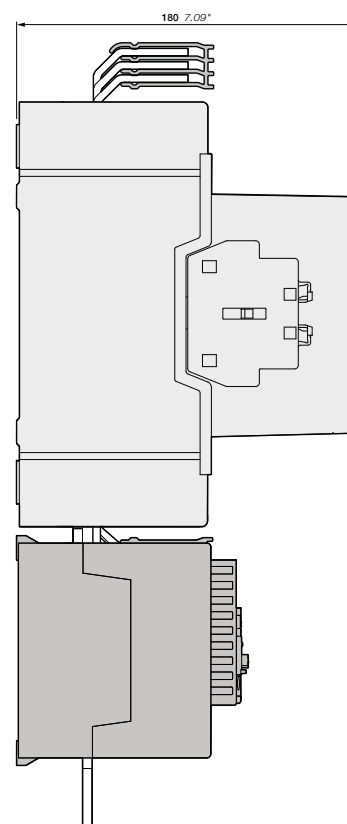
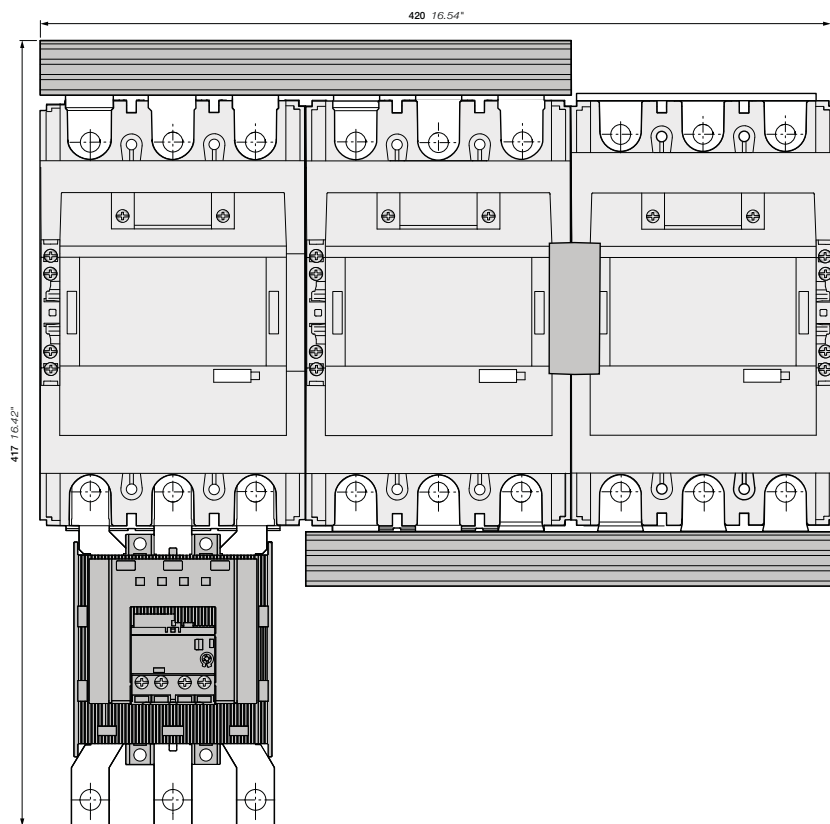

- AF205, AF305, AF370
- + BEY370-4, VM19
- + EF370 electronic overload relay

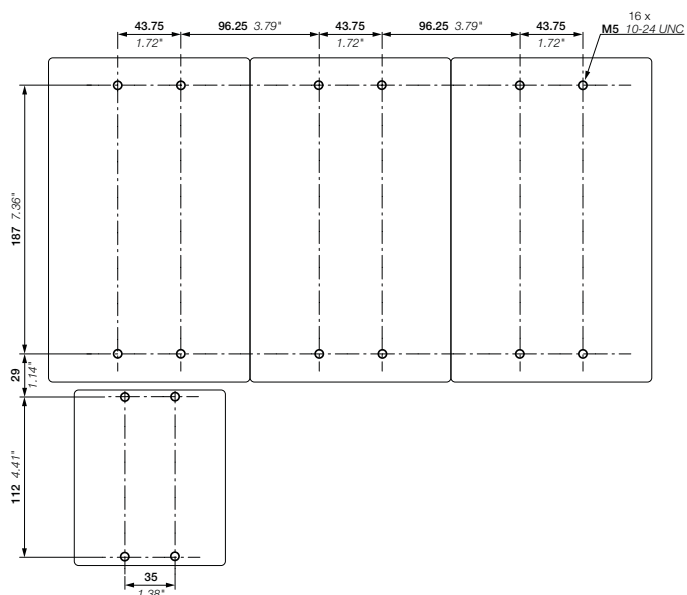

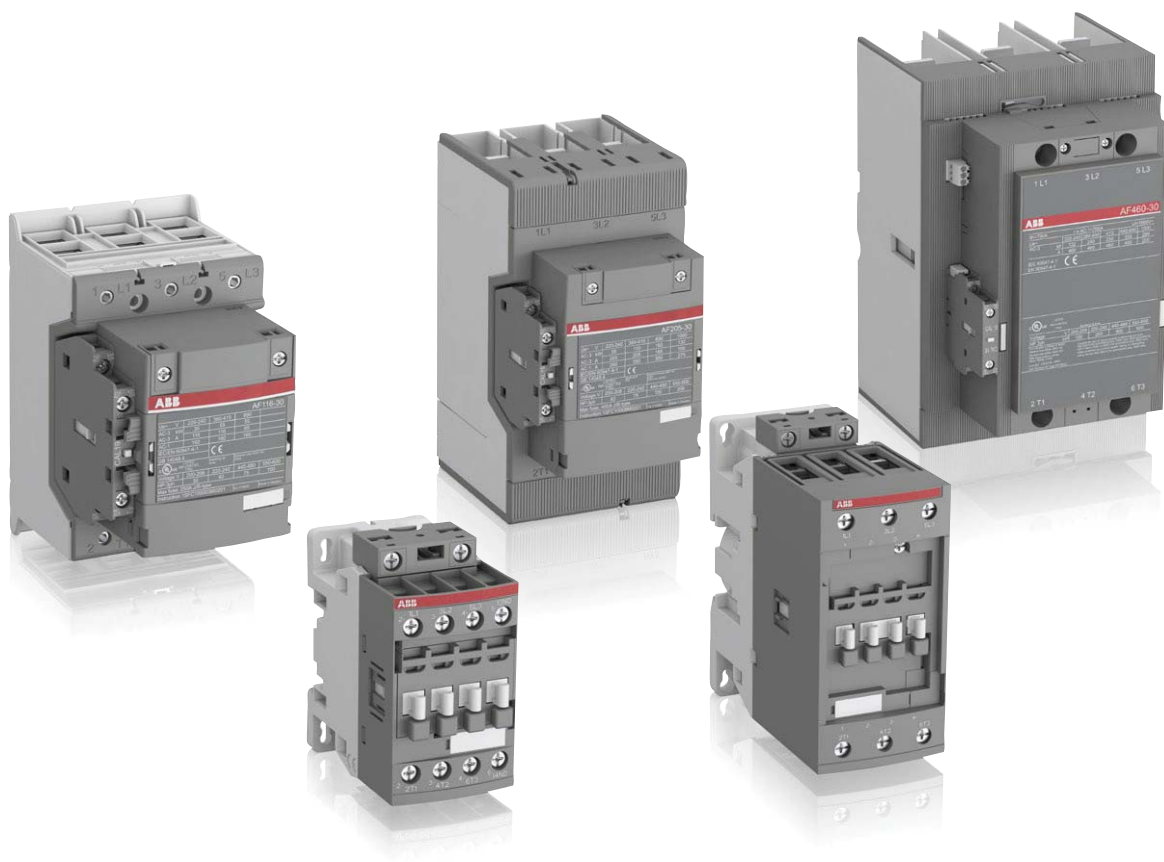

AF 3-pole contactors

[Overview](#) 5/82

Ordering details

4 to 45 kW / 5 to 60 hp

AF09 ... AF38	AC / DC operated	5/84
AF09Z ... AF38Z	AC / DC operated - low consumption	5/85
AF40 ... AF96	AC / DC operated	5/86
Main accessories		5/88

55 to 200 kW / 75 to 300 hp

AF116 ... AF146	AC / DC operated	5/90
AF190 ... AF370	AC / DC operated	5/92
Main accessories		5/94
AF116 ... AF146	AC / DC operated with 1 N.O. + 1 N.C.	5/96
AF190 ... AF370	AC / DC operated with 1 N.O. + 1 N.C.	5/98
Main accessories		5/100

200 to 560 kW / 350 to 900 hp

AF400 ... AF750	AC / DC operated with 1 N.O. + 1 N.C.	5/102
AF1250 ... AF2650	AC / DC operated with 1 N.O. + 1 N.C.	5/103
AF1350T ... AF2650T	with LVRT AC operated with 1 N.O. + 1 N.C.	5/105
Main accessories		5/106

4 to 45 kW / 5 to 60 hp - 2-stack

AF09 ... AF38	AC / DC operated	5/108
AF09Z ... AF38Z	AC / DC operated - low consumption	5/109
AF40 ... AF65	AC / DC operated	5/110
AF80 ... AF96	AC / DC operated	5/111
Main accessories		5/112

55 to 560 kW / 75 to 900 hp

AF116 ... AF146	AC / DC operated with 2 N.O. + 2 N.C.	5/114
AF190 ... AF370	AC / DC operated with 2 N.O. + 2 N.C.	5/116
Main accessories		5/118
AF400 ... AF750	AC / DC operated with 2 N.O. + 2 N.C.	5/120
AF1250 ... AF2650	AC / DC operated with 2 N.O. + 2 N.C.	5/121
Main accessories		5/122

[Technical data](#) 5/124

[Electrical durability](#) 5/143

[Terminal marking and positioning](#) 5/149

[Main dimensions](#) 5/152

[Voltage code table](#) 5/410

3-pole contactors, for motor control and power switching



AC / DC Control supply			Type	AF09	AF12	AF16	AF26	AF30	AF38	AF40	AF52	AF65	AF80	AF96	
IEC	AC-3	Rated operational power $\theta \leq 60^\circ\text{C}$ for AF09 ... AF370 $\theta \leq 55^\circ\text{C}$ for AF400 ... AF2650	220 - 230 - 240 V	kW	2.2	3	4	6.5	9	11	11	15	18.5	22	25
			380 - 400 V	kW	4	5.5	7.5	11	15	18.5	18.5	22	30	37	45
			415 V	kW	4	5.5	9	11	15	18.5	22	30	37	45	55
			440 V	kW	4	5.5	9	15	18.5	22	22	30	37	45	55
			500 V	kW	5.5	7.5	9	15	18.5	22	22	30	37	45	55
			690 V	kW	5.5	7.5	9	15	18.5	22	22	30	37	45	55
			1000 V	kW	—	—	—	—	—	—	—	—	—	—	35
	Rated operational current	380 - 400 V	A	9	12	18	26	32	38	40	53	65	80	96	
	AC-1	Rated operational current	$\theta \leq 40^\circ\text{C}$, 690 V	A	25	28	30	45	50	50	70	100	105	125	130

UL / CSA	1-phase motor rating	120 V	hp	0.75	1	1.5	2	2	2	3	3	5	7.5	7.5	
		240 V	hp	1.5	2	3	3	5	5	7.5	10	15	15	20	20
	3-phase motor rating	200 - 208 V	hp	2	3	5	7.5	10	10	10	15	20	25	30	30
		220 - 240 V	hp	2	3	5	7.5	10	10	15	20	25	30	30	
		440 - 480 V	hp	5	7.5	10	15	20	25	30	40	50	60	60	
	550 - 600 V	hp	7.5	10	15	20	25	30	40	50	60	75	75		
	General use rating	600 V	A	25	28	30	45	50	50	60	80	90	105	115	
NEMA	NEMA Size			00	0	—	1	—	—	2	—	—	3	—	

Main accessories

Auxiliary contact blocks	Front mounting	CA4-10 (1 x N.O.) CA4-01 (1 x N.C.)
	Side mounting	CAL4-11 (1 x N.O. + 1 x N.C.)
Timers	Electronic	TEF4-ON TEF4-OFF
	Mechanical	VM4
Interlocking units	Mechanical / Electrical	VM96-4
	For reversing contactors	VEM4
Connection sets		BER16-4 BER38-4 BER65-4 BER96-4
Surge suppressors		Built-in surge protection

Overload relays

Thermal relays	Class 10 (Class 10A for TF140, TA200DU)	TF42 (0.10...38 A)	TF65 (22...67 A)	TF96 (40...96 A)
Electronic relays	Class 10E, 20E, 30E	EF19 (0.10...18.9 A)	EF19 (0.10...18.9 A) EF45 (9...45 A)	EF65 (20...70 A)

Manual motor starters

	Thermal / magnetic protection Class 10	MS116 (0.10...32 A) lcs up to 50 kA for class 10 A MS132 (0.10...32 A) lcs up to 100 kA	MS165 (10...65 A) lcs up to 100 kA (1)	MS5100 (40...100 A) lcs up to 50 kA MS495 (45...100 A) lcs up to 50 kA
	Magnetic only types	MO132 (0.16...32 A) lcs up to 100 kA	MO165 (16...65 A) lcs up to 100 kA (1)	MO5100 (70...100 A) lcs up to 36 kA MO496 (32...100 A) lcs up to 100 kA
Accessories	For contactor mounting	BEA16-4	BEA38-4	BEA65-4 (2)
				MO495 (63...100 A) lcs up to 50 kA

(1) MS165/MO165 are suitable for use with AF09 ... AF30 for North American applications.
(2) BEA65-4 suitable for MS165 and MO165 only.

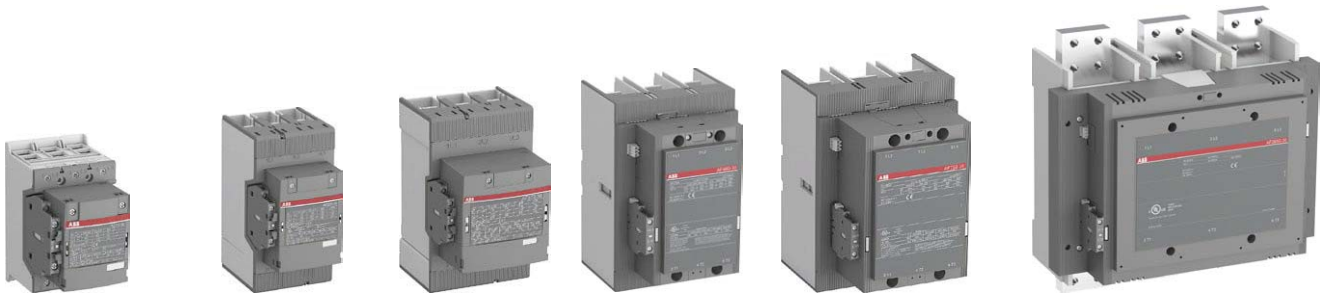

AF116	AF140	AF146	AF190	AF205	AF265	AF305	AF370	AF400	AF460	AF580	AF750	AF1250	AF1350	AF1650	AF2050	AF2650
30	37	45	55	55	75	90	110	110	132	160	220	—	257	315	—	—
55	75	75	90	110	132	160	200	200	250	315	400	—	475	560	—	—
55	75	75	90	110	132	160	200	220	250	355	425	—	500	630	—	—
75	90	90	110	132	160	160	200	220	250	355	450	—	560	710	—	—
75	90	90	110	132	160	200	250	250	315	400	520	—	560	710	—	—
55	75	90	132	160	200	250	315	315	355	500	600	—	800	1000	—	—
—	—	75	110	132	132	132	132	220	280	355	400	—	—	—	—	—
116	140	146	190	205	265	305	370	400	460	580	750	—	860	1060	—	—
160	200	225	275	350	400	500	600	600	700	800	1050	1260	1350	1650	2050	2650

—	—	—	—	—	—	—	—	—	—	—	—	—	—	—	—	—
—	—	—	—	—	—	—	—	—	—	—	—	—	—	—	—	—
30	40	40	50	60	75	100	125	125	150	200	250	—	—	—	—	—
40	50	50	60	75	100	125	150	150	200	250	300	—	400	450	—	—
75	100	100	125	150	200	250	300	350	400	500	600	—	800	900	—	—
100	125	125	150	200	250	300	350	400	500	600	700	—	1000	1150	—	—
160	200	200	250	300	350	400	520	550	650	750	900	1210	1350	1650	2100	2700
—	4	—	—	—	5	—	—	—	6	—	7	—	—	8	—	—

CAL19-11 (1 x N.O. + 1 x N.C.)								CAL18-11 (1 x N.O. + 1 x N.C.)							
VM19 (for same size contactors)								VM750H VM750V				VM1650H			
BER140-4			BER205-4			BER370-4			BEM460-30			BEM750-30			

TF140DU (66...142 A) $\theta \leq 55^\circ\text{C}$		TA200DU (66...200 A) $\theta \leq 55^\circ\text{C}$		EF370 (115...380 A)		EF460 (150...500 A)		EF750 (250...800 A)		E1250DU (375...1250 A)	
EF146 (54...150 A)		EF205 (63...210 A)									

Short-circuit protection devices

MCCB and switch-fuses



AF09 ... AF38 3-pole contactors

4 to 18.5 kW

AC / DC operated



AF09-30-10



AF26-30-00

5

Description

AF09 ... AF38 contactors are mainly used for controlling 3-phase motors and power circuits up to 690 V AC and 220 V DC. These contactors are of the block type design with 3 main poles.

- control circuit: AC or DC operated with electronic coil interface accepting a wide control voltage range (e.g. 100...250 V AC and DC), only 4 control voltage ranges covering 24...500V 50/60 Hz and 20...500 V DC
- can manage large control voltage variations
- reduced panel energy consumption
- very distinct closing and opening.
- built-in surge suppression
- add-on auxiliary contact blocks for front or side mounting and a wide range of accessories.

Ordering details

IEC		UL/CSA		Rated control circuit voltage		Auxiliary contacts fitted	Type (1)	Order code	Weight					
Rated operational power	current	3-phase motor rating	General use rating	Uc min. ... Uc max.						Pkg (1 pce)				
400 V AC-3	$\theta \leq 40^\circ\text{C}$	480 V	600 V AC	V 50/60 Hz	V DC				kg					
4	25	5	25	24...60	-	(2)	1 0	AF09-30-10-41	1SBL137001R4110	0.270				
							0 1	AF09-30-01-41	1SBL137001R4101	0.270				
							1 0	AF09-30-10-12	1SBL137001R1210	0.270				
							0 1	AF09-30-01-12	1SBL137001R1201	0.270				
							1 0	AF09-30-10-13	1SBL137001R1310	0.270				
							0 1	AF09-30-01-13	1SBL137001R1301	0.270				
				100...250	100...250	250...500	250...500	24...60	-	(2)	1 0	AF09-30-10-14	1SBL137001R1410	0.310
											0 1	AF09-30-01-14	1SBL137001R1401	0.310
											1 0	AF12-30-10-41	1SBL157001R4110	0.270
											0 1	AF12-30-01-41	1SBL157001R4101	0.270
											1 0	AF12-30-10-12	1SBL157001R1210	0.270
											0 1	AF12-30-01-12	1SBL157001R1201	0.270
5.5	28	7.5	28	100...250	100...250	1	0	AF12-30-10-13	1SBL157001R1310	0.270				
							0 1	AF12-30-01-13	1SBL157001R1301	0.270				
							1 0	AF12-30-10-14	1SBL157001R1410	0.310				
							0 1	AF12-30-01-14	1SBL157001R1401	0.310				
							1 0	AF16-30-10-41	1SBL177001R4110	0.270				
							0 1	AF16-30-01-41	1SBL177001R4101	0.270				
7.5	30	10	30	48...130	48...130	1	0	AF16-30-10-12	1SBL177001R1210	0.270				
							0 1	AF16-30-01-12	1SBL177001R1201	0.270				
							1 0	AF16-30-10-13	1SBL177001R1310	0.270				
							0 1	AF16-30-01-13	1SBL177001R1301	0.270				
							1 0	AF16-30-10-14	1SBL177001R1410	0.310				
							0 1	AF16-30-01-14	1SBL177001R1401	0.310				
11	45	15	45	250...500	250...500	0	0	AF16-30-10-13	1SBL177001R1310	0.270				
							0 1	AF16-30-01-13	1SBL177001R1301	0.270				
							1 0	AF26-30-00-41	1SBL237001R4100	0.310				
							0 0	AF26-30-00-12	1SBL237001R1200	0.310				
							0 0	AF26-30-00-13	1SBL237001R1300	0.310				
							0 0	AF26-30-00-14	1SBL237001R1400	0.350				
15	50	20	50	24...60	-	(2)	0	AF30-30-00-41	1SBL277001R4100	0.310				
							0 0	AF30-30-00-12	1SBL277001R1200	0.310				
							0 0	AF30-30-00-13	1SBL277001R1300	0.310				
							0 0	AF30-30-00-14	1SBL277001R1400	0.350				
							0 0	AF38-30-00-41	1SBL297001R4100	0.310				
							0 0	AF38-30-00-12	1SBL297001R1200	0.310				
18.5	50	25	50	100...250	100...250	0	0	AF38-30-00-13	1SBL297001R1300	0.310				
							0 0	AF38-30-00-14	1SBL297001R1400	0.350				
							0 0	AF38-30-00-12	1SBL297001R1200	0.310				
							0 0	AF38-30-00-13	1SBL297001R1300	0.310				
							0 0	AF38-30-00-14	1SBL297001R1400	0.350				
							0 0	AF38-30-00-12	1SBL297001R1200	0.310				

(1) For other auxiliary contacts arrangements, please contact your ABB local sales organization.

(2) For 24...60 V 50/60 Hz - 20...60 V DC, use AF.Z-30...-21.

Main dimensions mm, inches

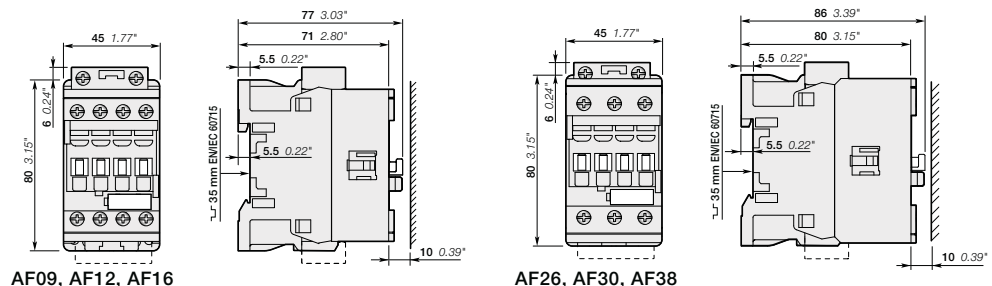

AF09Z ... AF38Z 3-pole contactors

4 to 18.5 kW

AC / DC operated - low consumption



AF09Z-30-10

1SBC101001W0014



AF26Z-30-00

1SBC101001W0014

Description

AF09Z ... AF38Z contactors are mainly used for controlling 3-phase motors and power circuits up to 690 V AC and 220 V DC. These contactors are of the block type design with 3 main poles.

- control circuit: AC or DC operated with electronic coil interface accepting a wide control voltage range (e.g. 100...250 V AC and DC), only 4 control voltage ranges covering 24...250 V 50/60 Hz and 12...250 V DC
- can manage large control voltage variations
- allow direct control by PLC-output ≥ 24 V DC 500 mA
- reduced panel energy consumption
- very distinct closing and opening
- can withstand short voltage dips and voltage sags (SEMI F47-0706 conditions of use on request).
- built-in surge suppression
- add-on auxiliary contact blocks for front or side mounting and a wide range of accessories.

Ordering details

IEC		UL/CSA		Rated control circuit voltage		Auxiliary contacts fitted		Type (1)	Order code	Weight
Rated power	operational current $\theta \leq 40^\circ\text{C}$	3-phase motor rating	General use rating	Uc min. ... Uc max.						Pkg (1 pce)
400 V AC-3 kW	AC-1 A	hp	A	V 50/60 Hz	V DC					kg
4	25	5	25	-	12...20	1	0	AF09Z-30-10-20	1SBL136001R2010	0.310
				24...60	20...60	0	1	AF09Z-30-01-20	1SBL136001R2001	0.310
				48...130	48...130	1	0	AF09Z-30-10-21	1SBL136001R2110	0.310
				100...250	100...250	0	1	AF09Z-30-01-21	1SBL136001R2101	0.310
						1	0	AF09Z-30-10-22	1SBL136001R2210	0.310
		0	1	AF09Z-30-01-22	1SBL136001R2201	0.310				
		1	0	AF09Z-30-10-23	1SBL136001R2310	0.310				
		0	1	AF09Z-30-01-23	1SBL136001R2301	0.310				
5.5	28	7.5	28	-	12...20	1	0	AF12Z-30-10-20	1SBL156001R2010	0.310
				24...60	20...60	0	1	AF12Z-30-01-20	1SBL156001R2001	0.310
				48...130	48...130	1	0	AF12Z-30-10-21	1SBL156001R2110	0.310
				100...250	100...250	0	1	AF12Z-30-01-21	1SBL156001R2101	0.310
						1	0	AF12Z-30-10-22	1SBL156001R2210	0.310
		0	1	AF12Z-30-01-22	1SBL156001R2201	0.310				
		1	0	AF12Z-30-10-23	1SBL156001R2310	0.310				
		0	1	AF12Z-30-01-23	1SBL156001R2301	0.310				
7.5	30	10	30	-	12...20	1	0	AF16Z-30-10-20	1SBL176001R2010	0.310
				24...60	20...60	0	1	AF16Z-30-01-20	1SBL176001R2001	0.310
				48...130	48...130	1	0	AF16Z-30-10-21	1SBL176001R2110	0.310
				100...250	100...250	0	1	AF16Z-30-01-21	1SBL176001R2101	0.310
						1	0	AF16Z-30-10-22	1SBL176001R2210	0.310
		0	1	AF16Z-30-01-22	1SBL176001R2201	0.310				
		1	0	AF16Z-30-10-23	1SBL176001R2310	0.310				
		0	1	AF16Z-30-01-23	1SBL176001R2301	0.310				
11	45	15	45	-	12...20	0	0	AF26Z-30-00-20	1SBL236001R2000	0.350
				24...60	20...60	0	0	AF26Z-30-00-21	1SBL236001R2100	0.350
				48...130	48...130	0	0	AF26Z-30-00-22	1SBL236001R2200	0.350
				100...250	100...250	0	0	AF26Z-30-00-23	1SBL236001R2300	0.350
15	50	20	50	-	12...20	0	0	AF30Z-30-00-20	1SBL276001R2000	0.350
				24...60	20...60	0	0	AF30Z-30-00-21	1SBL276001R2100	0.350
				48...130	48...130	0	0	AF30Z-30-00-22	1SBL276001R2200	0.350
				100...250	100...250	0	0	AF30Z-30-00-23	1SBL276001R2300	0.350
18.5	50	25	50	-	12...20	0	0	AF38Z-30-00-20	1SBL296001R2000	0.350
				24...60	20...60	0	0	AF38Z-30-00-21	1SBL296001R2100	0.350
				48...130	48...130	0	0	AF38Z-30-00-22	1SBL296001R2200	0.350
				100...250	100...250	0	0	AF38Z-30-00-23	1SBL296001R2300	0.350

(1) For other auxiliary contacts arrangements, please contact your ABB local sales organization.

Note: Only AF.Z contactors with DC control voltage 12...20 V DC need to respect the connection polarities indicated close to the coil terminals: A1+ for the positive pole and A2- for the negative pole.

Main dimensions mm, inches

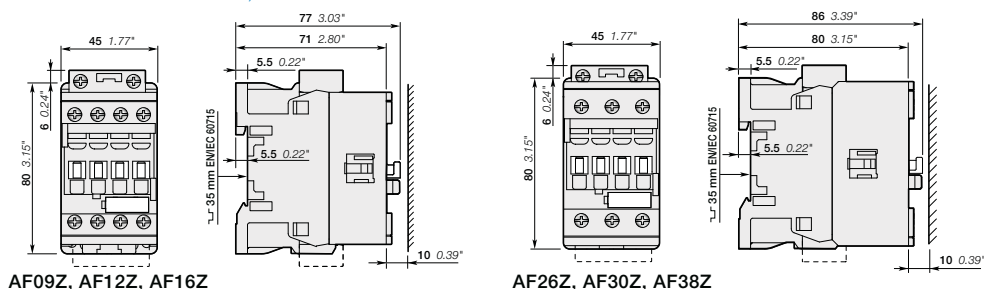

AF09Z, AF12Z, AF16Z

AF26Z, AF30Z, AF38Z

1SBC10137250201 - Rev. B

AF40 ... AF96 3-pole contactors

18.5 to 45 kW

AC / DC operated



AF40-30-00



AF80-30-00

Description

AF40 ... AF96 contactors are mainly used for controlling 3-phase motors and power circuits up to 690 V AC and 220 V DC. These contactors are of the block type design with 3 main poles.

- control circuit: AC or DC operated with electronic coil interface accepting a wide control voltage range (e.g. 100...250 V AC and DC), only 4 control voltage ranges covering 24...500 V 50/60 Hz and 20...500 V DC
- can manage large control voltage variations
- reduced panel energy consumption
- very distinct closing and opening.
- built-in surge suppression
- add-on auxiliary contact blocks for front or side mounting and a wide range of accessories.

Ordering details

IEC Rated operational power 400 V AC-3 kW	UL / CSA 3-phase motor rating 480 V AC-1 A	General use rating 600 V AC hp	General use rating A	Rated control circuit voltage Uc min. ... Uc max.		Auxiliary contacts fitted	Type (1)	Order code	Weight Pkg (1 pce) kg
				V 50/60 Hz	V DC				
18.5	70	30	60	24...60	-	0 0	AF40-30-00-41	1SBL347001R4100	0.970
				24...60	20...60 (2)	0 0	AF40-30-00-11	1SBL347001R1100	0.970
				48...130	48...130	0 0	AF40-30-00-12	1SBL347001R1200	0.970
				100...250	100...250	0 0	AF40-30-00-13	1SBL347001R1300	0.950
22	100	40	80	250...500	250...500	0 0	AF40-30-00-14	1SBL347001R1400	0.950
				24...60	-	0 0	AF52-30-00-41	1SBL367001R4100	0.970
				24...60	20...60 (2)	0 0	AF52-30-00-11	1SBL367001R1100	0.970
				48...130	48...130	0 0	AF52-30-00-12	1SBL367001R1200	0.970
30	105	50	90	100...250	100...250	0 0	AF52-30-00-13	1SBL367001R1300	0.950
				250...500	250...500	0 0	AF52-30-00-14	1SBL367001R1400	0.950
				24...60	-	0 0	AF65-30-00-41	1SBL387001R4100	0.970
				24...60	20...60 (2)	0 0	AF65-30-00-11	1SBL387001R1100	0.970
37	125	60	105	48...130	48...130	0 0	AF65-30-00-12	1SBL387001R1200	0.970
				100...250	100...250	0 0	AF65-30-00-13	1SBL387001R1300	0.950
				250...500	250...500	0 0	AF65-30-00-14	1SBL387001R1400	0.950
				24...60	-	0 0	AF80-30-00-41	1SBL397001R4100	1.220
45	130	60	115	24...60	20...60 (2)	0 0	AF80-30-00-11	1SBL397001R1100	1.220
				48...130	48...130	0 0	AF80-30-00-12	1SBL397001R1200	1.220
				100...250	100...250	0 0	AF80-30-00-13	1SBL397001R1300	1.170
				250...500	250...500	0 0	AF80-30-00-14	1SBL397001R1400	1.170
				24...60	-	0 0	AF96-30-00-41	1SBL407001R4100	1.220
				24...60	20...60 (2)	0 0	AF96-30-00-11	1SBL407001R1100	1.220
				48...130	48...130	0 0	AF96-30-00-12	1SBL407001R1200	1.220
				100...250	100...250	0 0	AF96-30-00-13	1SBL407001R1300	1.170
				250...500	250...500	0 0	AF96-30-00-14	1SBL407001R1400	1.170

(1) For other auxiliary contacts arrangements, please contact your ABB local sales organization.

(2) AF...-30...-11 not suitable for direct control by PLC-output.

Main dimensions mm, inches

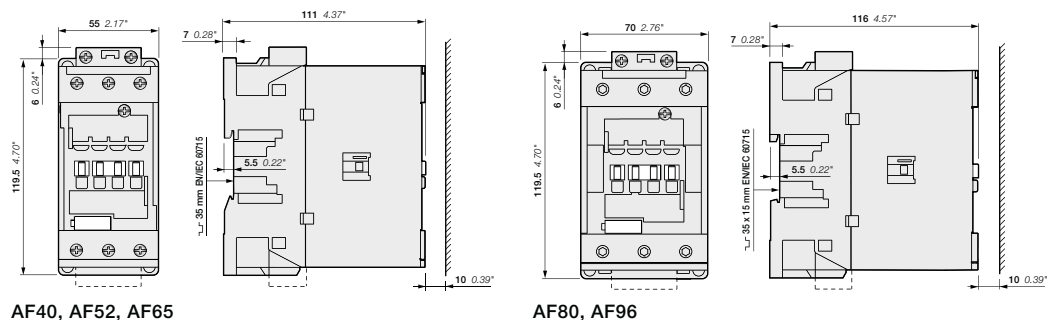

AF40, AF52, AF65

AF80, AF96

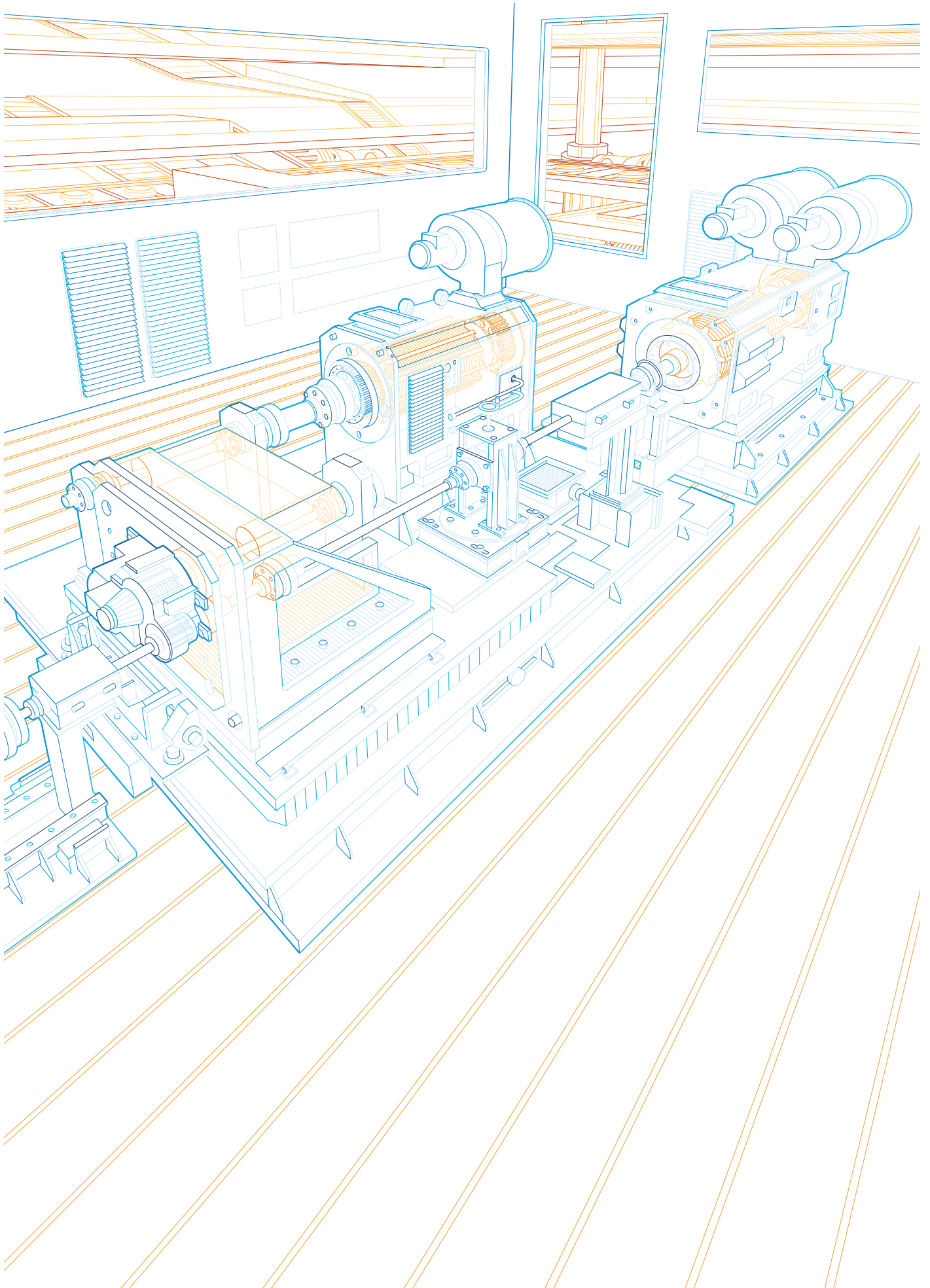

AF09 ... AF96 3-pole contactors

Main accessories

Contactor and main accessories (other accessories available)

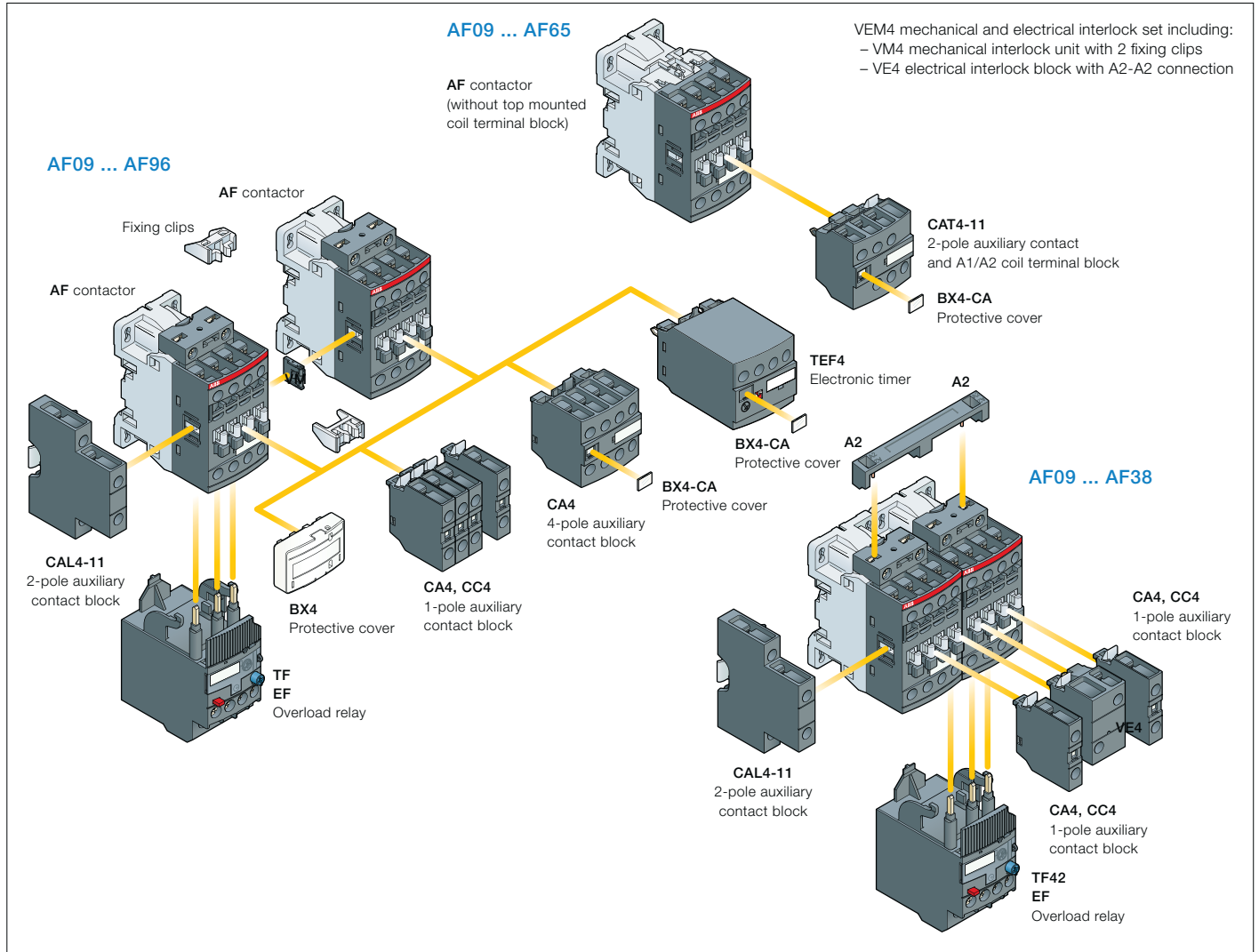

Main accessory fitting details

Many configurations of accessories are possible depending on whether these are front-mounted or side-mounted.

Contactor types	Main poles	Built-in auxiliary contacts	Front-mounted accessories				Electronic timer	Electrical and mechanical interlock set (between 2 contactors)	Side-mounted accessories	
			Auxiliary contact blocks			TEF4			VEM4	Left side
			1-pole CA4	1-pole CC4	2-pole CAT4-11	4-pole CA4			2-pole CAL4-11	
Max. N.C. built-in and add-on N.C. auxiliary contacts: 4 N.C. max. on positions 1, 2, 3, 4 and 3 N.C. max. on positions 1 ±30°, 5										
AF09 ... AF16	3	0	0	1	4 max. or 1	or 1	or 1	-	+ 1	-
AF09 ... AF16	3	0	1	0	2 max. or 1	-	or 1	-	+ 1	+ 1
AF26 ... AF38	3	0	0	0	3 max.	-	-	+ 1	+ 1	or 1
Max. add-on N.C. auxiliary contacts: 6 N.C. max. on positions 1, 1 ±30°, 2, 3, 4, 5										
AF40 ... AF65	3	0	0	0	4 max. or 1	or 1	or 1	-	+ 1	+ 1
AF80, AF96	3	0	0	0	4 max.	-	or 1	-	+ 1	+ 1

Overload relays fitting details (1)

Contactor types	Thermal overload relays	Electronic overload relays
AF09 ... AF38	TF42 (0.10...38 A)	EF19 (0.10...19 A)
AF26 ... AF38	TF42 (0.10...38 A)	EF45 (9...45 A)
AF40 ... AF65	TF65 (22...67 A)	EF65 (20...70 A)
AF80, AF96	TF96 (40...96 A)	EF96 (36...100 A)

The addition of an overload relay on the contactor does not prevent fitting of many other accessories as shown above.

(1) Direct mounting - No kit required.

AF09 ... AF96 3-pole contactors

Main accessories



CA4-10



CAL4-11



CA4-22E



CAT4-11E

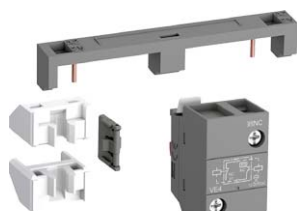

VEM4

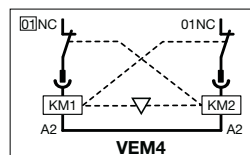

TEF4-ON



BEA16-4

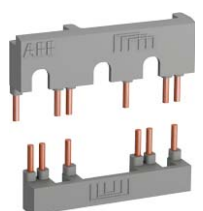

BER16-4

Ordering details (1)

For contactors	Auxiliary contacts	Type	Order code	Pkg qty	Weight (1 pce)
					kg

Front-mounted instantaneous auxiliary contact blocks

AF09 ... AF96	1 0	--	CA4-10	1SBN010110R1010	1	0.014
	1 0	--	CA4-10-T	1SBN010110T1010	10	0.014
	0 1	--	CA4-01	1SBN010110R1001	1	0.014
	0 1	--	CA4-01-T	1SBN010110T1001	10	0.014
AF09 ... AF16...-30-10	2 2	--	CA4-22M	1SBN010140R1122	1	0.055
AF26 ... AF96...-30-00	2 2	--	CA4-22E	1SBN010140R1022	1	0.055
AF09 ... AF16...-30-01	2 2	--	CA4-22U	1SBN010140R1322	1	0.055

Front-mounted auxiliary contact blocks with N.O. leading contact and N.C. lagging contact

AF09 ... AF96	--	1 0	CC4-10	1SBN010111R1010	1	0.014
	--	0 1	CC4-01	1SBN010111R1001	1	0.014

Side-mounted instantaneous auxiliary contact blocks

AF09 ... AF96	1 1	--	CAL4-11	1SBN010120R1011	1	0.040
	1 1	--	CAL4-11-T	1SBN010120T1011	10	0.040

Front-mounted instantaneous auxiliary contact and A1/A2 coil terminal blocks

AF09 ... AF16...-30-10	1 1	--	CAT4-11M	1SBN010151R1111	1	0.040
AF26 ... AF65...-30-00	1 1	--	CAT4-11E	1SBN010151R1011	1	0.040
AF09 ... AF16...-30-01	1 1	--	CAT4-11U	1SBN010151R1311	1	0.040

Note: CAT4 not suitable for AF..Z contactors with DC control voltage 12...20 V DC.

Mechanical interlock unit

AF09 ... AF38			VM4	1SBN030105T1000	10	0.005
AF40 ... AF96			VM96-4	1SBN033405T1000	10	0.006

Note: VM4 and VM96-4 include 2 fixing clips (BB4) to maintain together both contactors.

Mechanical and electrical interlock set

AF09 ... AF16	0 2	--	VEM4	1SBN030111R1000	1	0.035
AF26 ... AF38						

Note: - VEM4 includes a VM4 mechanical interlock unit with 2 fixing clips (BB4), a VE4 electrical interlock block. VE4 block must be used with A2-A2 connection to respect the electrical connection diagram.
- VEM4 not suitable for AF..Z contactors with DC control voltage 12...20 V DC.

For contactors	Time delay range	Delay type	Auxiliary contacts	Type	Order code	Pkg qty	Weight (1 pce)
	selected by switch						kg

Electronic timers

AF09 ... AF96	0.1...1 s	ON-delay	1 1	TEF4-ON	1SBN020112R1000	1	0.065
	1...10 s						
	10...100 s	OFF-delay	1 1	TEF4-OFF	1SBN020114R1000	1	0.065

Note: Rated control circuit voltage Uc 24...240 V 50/60 Hz or DC.

Connecting links with manual motor starters

AF09 ... AF16	with	MS116-0.16 ... MS116-25, MS132-0.16 ... MS132-25		BEA16-4	1SBN081306T1000	10	0.025
AF26 ... AF38	with	MS116-0.16 ... MS116-16, MS132-0.16 ... MS132-10		BEA26-4	1SBN082306T1000	10	0.025
	with	MS116-20 ... MS116-32, MS132-12 ... MS132-32		BEA38-4	1SBN082306T2000	10	0.030
AF40 ... AF65	with	MS165-16 ... MS165-65		BEA65-4	1SBN083406R1000	1	0.090

Connection sets for reversing contactors

AF09 ... AF16				BER16-4	1SBN081311R1000	1	0.045
AF26 ... AF38				BER38-4	1SBN082311R1000	1	0.100
AF40 ... AF65				BER65-4	1SBN083411R1000	1	0.175
AF80 ... AF96				BER96-4	1SBN083911R1000	1	0.250

Connection sets for star-delta starting

AF09 ... AF16	With or without VM4			BEY16-4	1SBN081313R2000	1	0.050
AF26 ... AF38	With or without VM4			BEY38-4	1SBN082713R2000	1	0.110
AF40 ... AF65	With or without VM96-4			BEY65-4	1SBN083413R2000	1	0.200
AF80 ... AF96	With or without VM96-4			BEY96-4	1SBN083913R2000	1	0.250

(1) For more information, refer to main catalog "Accessories" section.

AF116 ... AF146 3-pole contactors

55 to 75 kW

AC / DC operated



AF146-30-00

1SFC101008V0001



AF146-30-00B

1SFC101008V0001

Description

AF116 ... AF146 contactors are mainly used for controlling 3-phase motors and power circuits up to 690 V AC, AF146 up to 1000 V AC and AF116 ... AF146 up to 260 V DC. These contactors are of the block type design with 3 main poles.

- control circuit: AC or DC operated with electronic coil interface accepting a wide control voltage range (e.g. 100...250 V AC and DC), only 4 coils to cover control voltages between 24...500 V 50/60 Hz and 20...500 V DC
- can manage large control voltage variations
- reduced panel energy consumption
- very distinct closing and opening
- can withstand short voltage dips and voltage sags (SEMI F47 conditions of use on request).
- built-in surge suppression
- add-on auxiliary contact blocks for side mounting and a wide range of accessories.

Ordering details

IEC		UL / CSA		Rated control circuit voltage Uc min. ... Uc max.	Auxiliary contacts fitted	Type (1)	Order code	Weight Pkg (1 pce) kg
Rated operational power kW	current A	3-phase motor rating hp	General use rating A					
400 V AC-3	AC-1	480 V	600 V AC	V 50/60 Hz; V DC				

For connection with built-in cable clamps

Rated operational power (kW)	Rated current (A)	3-phase motor rating (hp)	General use rating (A)	Uc min. (V)	Uc max. (V)	Auxiliary contacts	Type	Order code	Weight (kg)
55	160	75	160	24...60	20...60	0 0	AF116-30-00-11	1SFL427001R1100	1.750
				48...130	48...130	0 0	AF116-30-00-12	1SFL427001R1200	1.750
				100...250	100...250	0 0	AF116-30-00-13	1SFL427001R1300	1.750
				250...500	250...500	0 0	AF116-30-00-14	1SFL427001R1400	1.750
75	200	100	200	24...60	20...60	0 0	AF140-30-00-11	1SFL447001R1100	1.750
				48...130	48...130	0 0	AF140-30-00-12	1SFL447001R1200	1.750
				100...250	100...250	0 0	AF140-30-00-13	1SFL447001R1300	1.750
				250...500	250...500	0 0	AF140-30-00-14	1SFL447001R1400	1.750
75	225	100	200	24...60	20...60	0 0	AF146-30-00-11	1SFL467001R1100	1.750
				48...130	48...130	0 0	AF146-30-00-12	1SFL467001R1200	1.750
				100...250	100...250	0 0	AF146-30-00-13	1SFL467001R1300	1.750
				250...500	250...500	0 0	AF146-30-00-14	1SFL467001R1400	1.750

With bar connections

Rated operational power (kW)	Rated current (A)	3-phase motor rating (hp)	General use rating (A)	Uc min. (V)	Uc max. (V)	Auxiliary contacts	Type	Order code	Weight (kg)
55	160	75	160	24...60	20...60	0 0	AF116-30-00B-11	1SFL427002R1100	1.500
				48...130	48...130	0 0	AF116-30-00B-12	1SFL427002R1200	1.500
				100...250	100...250	0 0	AF116-30-00B-13	1SFL427002R1300	1.500
				250...500	250...500	0 0	AF116-30-00B-14	1SFL427002R1400	1.500
75	200	100	200	24...60	20...60	0 0	AF140-30-00B-11	1SFL447002R1100	1.500
				48...130	48...130	0 0	AF140-30-00B-12	1SFL447002R1200	1.500
				100...250	100...250	0 0	AF140-30-00B-13	1SFL447002R1300	1.500
				250...500	250...500	0 0	AF140-30-00B-14	1SFL447002R1400	1.500
75	225	100	200	24...60	20...60	0 0	AF146-30-00B-11	1SFL467002R1100	1.500
				48...130	48...130	0 0	AF146-30-00B-12	1SFL467002R1200	1.500
				100...250	100...250	0 0	AF146-30-00B-13	1SFL467002R1300	1.500
				250...500	250...500	0 0	AF146-30-00B-14	1SFL467002R1400	1.500

(1) For other auxiliary contacts arrangements, please contact your ABB local sales organization.

Main dimensions mm, inches

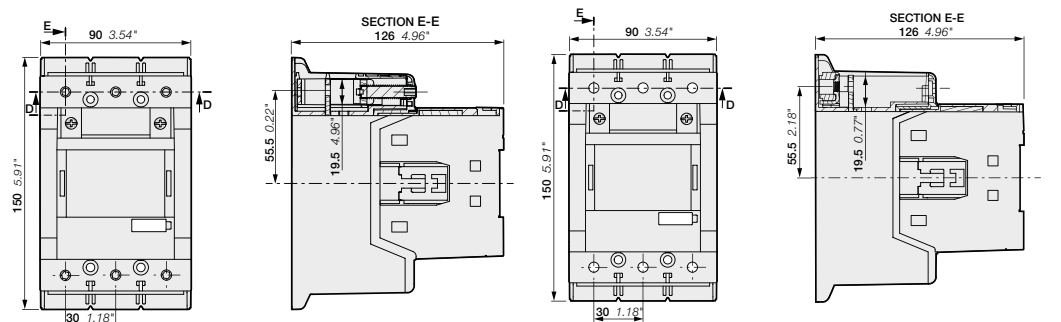

AF116, AF140, AF146-30-00

AF116, AF140, AF146-30-00B

AF116 ... AF146 3-pole contactors with built-in PLC interface

55 to 75 kW

AC / DC operated



AF146-30-00



AF146-30-00B

Description

AF116 ... AF146 contactors are mainly used for controlling 3-phase motors and power circuits up to 690 V AC, AF146 up to 1000 V AC and AF116 ... AF146 up to 260 V DC. These contactors are of the block type design with 3 main poles.

- control circuit: AC or DC operated with electronic coil interface accepting a wide control voltage range (e.g. 100...500 V AC and DC), only 2 coils to cover control voltages between 100...500 V 50/60 Hz and 100...250 V DC
- can manage large control voltage variations
- reduced panel energy consumption
- very distinct closing and opening
- can withstand short voltage dips and voltage sags (SEMI F47 conditions of use on request).
- built-in surge suppression
- add-on auxiliary contact blocks for side mounting and a wide range of accessories.

Ordering details

IEC		UL / CSA		Rated control circuit voltage		Auxiliary contacts fitted	Type (1)	Order code	Weight Pkg (1 pce)
Rated operational power	current $\theta \leq 40^\circ\text{C}$	3-phase motor rating	General use rating	Uc min. ...	Uc max.				
400 V AC-3	AC-1	480 V	600 V AC	V 50/60 Hz	V DC				kg
kW	A	hp	A						

For connection with built-in cable clamps

55	160	75	160	100...250	100...250	0 0	AF116-30-00-33	1SFL427001R3300	1.750
				250...500	250...500	0 0	AF116-30-00-34	1SFL427001R3400	1.750
75	200	100	200	100...250	100...250	0 0	AF140-30-00-33	1SFL447001R3300	1.750
				250...500	250...500	0 0	AF140-30-00-34	1SFL447001R3400	1.750
75	225	100	200	100...250	100...250	0 0	AF146-30-00-33	1SFL467001R3300	1.750
				250...500	250...500	0 0	AF146-30-00-34	1SFL467001R3400	1.750

With bar connections

55	160	75	160	100...250	100...250	0 0	AF116-30-00B-33	1SFL427002R3300	1.500
				250...500	250...500	0 0	AF116-30-00B-34	1SFL427002R3400	1.500
75	200	100	200	100...250	100...250	0 0	AF140-30-00B-33	1SFL447002R3300	1.500
				250...500	250...500	0 0	AF140-30-00B-34	1SFL447002R3400	1.500
75	225	100	200	100...250	100...250	0 0	AF146-30-00B-33	1SFL467002R3300	1.500
				250...500	250...500	0 0	AF146-30-00B-34	1SFL467002R3400	1.500

(1) For other auxiliary contacts arrangements, please contact your ABB local sales organization.

AF116 ... AF146 are equipped with low voltage inputs for control, for example by a PLC.

Control inputs

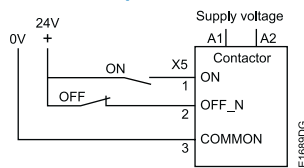

Main dimensions mm, inches

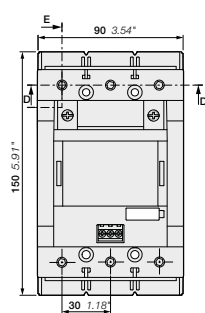

AF116, AF140, AF146-30-00

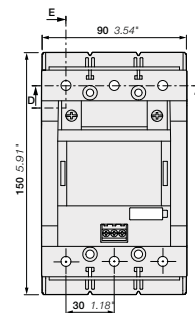
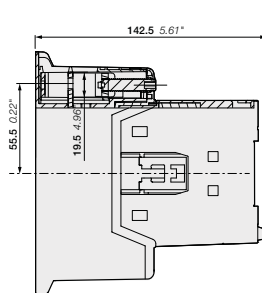

AF116, AF140, AF146-30-00B

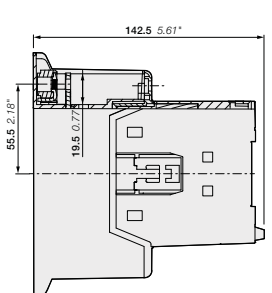

AF190 ... AF370 3-pole contactors

90 to 200 kW

AC / DC operated



AF205-30-00



AF370-30-00

Description

AF190 ... AF370 contactors are mainly used for controlling 3-phase motors and power circuits up to 1000 V AC and 340 V DC. These contactors are of the block type design with 3 main poles.

- control circuit: AC or DC operated with electronic coil interface accepting a wide control voltage range (e.g. 100...250 V AC and DC), only 4 coils to cover control voltages between 24...500 V 50/60 Hz and 20...500 V DC
 - can manage large control voltage variations
 - reduced panel energy consumption
 - very distinct closing and opening
 - can withstand short voltage dips and voltage sags (SEMI F47 conditions of use on request).
- built-in surge suppression
- add-on auxiliary contact blocks for side mounting and a wide range of accessories.

Ordering details

IEC		UL / CSA		Rated control circuit voltage		Auxiliary contacts fitted	Type (1)	Order code	Weight
Rated operational power	current $\theta \leq 40^\circ\text{C}$	3-phase motor rating	General use rating	Uc min. ... Uc max.					Pkg (1 pce) kg
400 V AC-3 kW	AC-1 A	hp	A	V 50/60 Hz	V DC				
90	275	125	250	24...60	20...60	0 0	AF190-30-00-11	1SFL487002R1100	3,000
				48...130	48...130	0 0	AF190-30-00-12	1SFL487002R1200	3,000
				100...250	100...250	0 0	AF190-30-00-13	1SFL487002R1300	3,000
				250...500	250...500	0 0	AF190-30-00-14	1SFL487002R1400	3,000
110	350	150	300	24...60	20...60	0 0	AF205-30-00-11	1SFL527002R1100	3,000
				48...130	48...130	0 0	AF205-30-00-12	1SFL527002R1200	3,000
				100...250	100...250	0 0	AF205-30-00-13	1SFL527002R1300	3,000
				250...500	250...500	0 0	AF205-30-00-14	1SFL527002R1400	3,000
132	400	200	350	24...60	20...60	0 0	AF265-30-00-11	1SFL547002R1100	4,605
				48...130	48...130	0 0	AF265-30-00-12	1SFL547002R1200	4,605
				100...250	100...250	0 0	AF265-30-00-13	1SFL547002R1300	4,605
				250...500	250...500	0 0	AF265-30-00-14	1SFL547002R1400	4,605
160	500	250	400	24...60	20...60	0 0	AF305-30-00-11	1SFL587002R1100	4,605
				48...130	48...130	0 0	AF305-30-00-12	1SFL587002R1200	4,605
				100...250	100...250	0 0	AF305-30-00-13	1SFL587002R1300	4,605
				250...500	250...500	0 0	AF305-30-00-14	1SFL587002R1400	4,605
200	600	300	520	24...60	20...60	0 0	AF370-30-00-11	1SFL607002R1100	4,605
				48...130	48...130	0 0	AF370-30-00-12	1SFL607002R1200	4,605
				100...250	100...250	0 0	AF370-30-00-13	1SFL607002R1300	4,605
				250...500	250...500	0 0	AF370-30-00-14	1SFL607002R1400	4,605

(1) For other auxiliary contacts arrangements, please contact your ABB local sales organization.

Main dimensions mm, inches

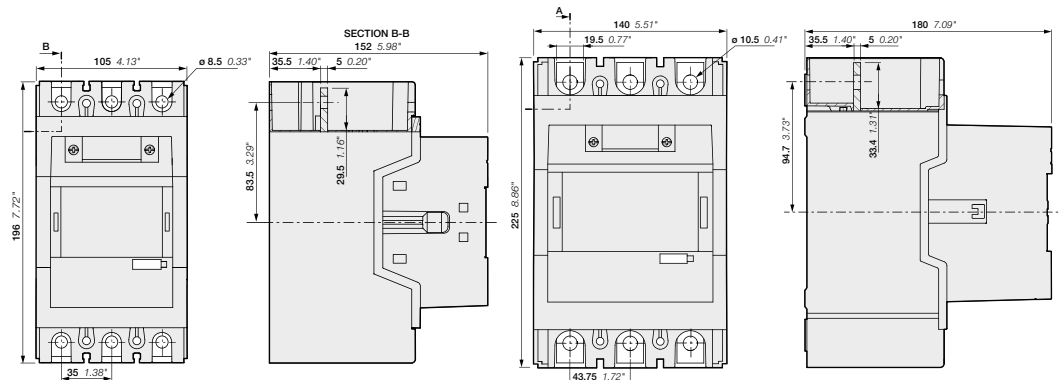

AF190, AF205

AF265, AF305, AF370

AF190 ... AF370 3-pole contactors with built-in PLC interface

90 to 200 kW

AC / DC operated



1SFC101167V0001

AF205-30-00



1SFC101132V0001

AF370-30-00

Description

AF190 ... AF370 contactors are mainly used for controlling 3-phase motors and power circuits up to 1000 V AC and 340 V DC. These contactors are of the block type design with 3 main poles.

- control circuit: AC or DC operated with electronic coil interface accepting a wide control voltage range (e.g. 100...250 V AC and DC), only 2 coils to cover control voltages between 100...500 V 50/60 Hz and 100...500 V DC
- can manage large control voltage variations
- reduced panel energy consumption
- very distinct closing and opening
- can withstand short voltage dips and voltage sags (SEMI F47 conditions of use on request).
- built-in surge suppression
- add-on auxiliary contact blocks for side mounting and a wide range of accessories.

Ordering details

IEC		UL / CSA		Rated control circuit voltage		Auxiliary contacts fitted		Type (1)	Order code	Weight
Rated operational power	current $\theta \leq 40^\circ\text{C}$	3-phase motor rating	General use rating	Uc min.	Uc max.	I Y L				Pkg (1 pce)
400 V AC-3	AC-1	480 V	600 V AC	V 50/60 Hz	V DC					kg
90	275	125	250	100...250	100...250	0	0	AF190-30-00-33	1SFL487002R3300	3.000
				250...500	250...500	0	0	AF190-30-00-34	1SFL487002R3400	3.000
110	350	150	300	100...250	100...250	0	0	AF205-30-00-33	1SFL527002R3300	3.000
				250...500	250...500	0	0	AF205-30-00-34	1SFL527002R3400	3.000
132	400	200	350	100...250	100...250	0	0	AF265-30-00-33	1SFL547002R3300	4.605
				250...500	250...500	0	0	AF265-30-00-34	1SFL547002R3400	4.605
160	500	250	400	100...250	100...250	0	0	AF305-30-00-33	1SFL587002R3300	4.605
				250...500	250...500	0	0	AF305-30-00-34	1SFL587002R3400	4.605
200	600	300	520	100...250	100...250	0	0	AF370-30-00-33	1SFL607002R3300	4.605
				250...500	250...500	0	0	AF370-30-00-34	1SFL607002R3400	4.605

(1) For other auxiliary contacts arrangements, please contact your ABB local sales organization.

AF190 ... AF370 are equipped with low voltage inputs for control, for example by a PLC.

Control inputs

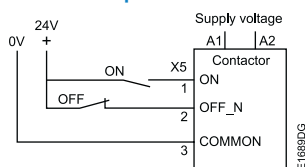

Main dimensions mm, inches

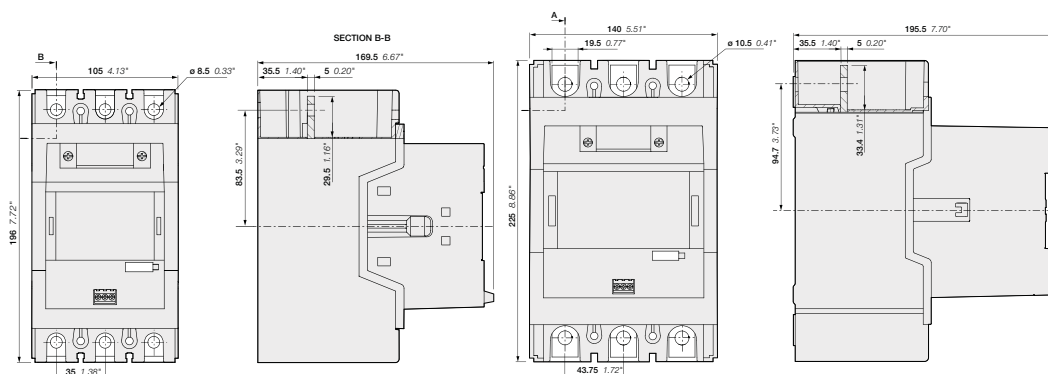

AF190, AF205

AF265, AF305, AF370

1SFC101165C0201 - Rev. A

AF116 ... AF370 3-pole contactors

Main accessories

Main accessories (other accessories available)

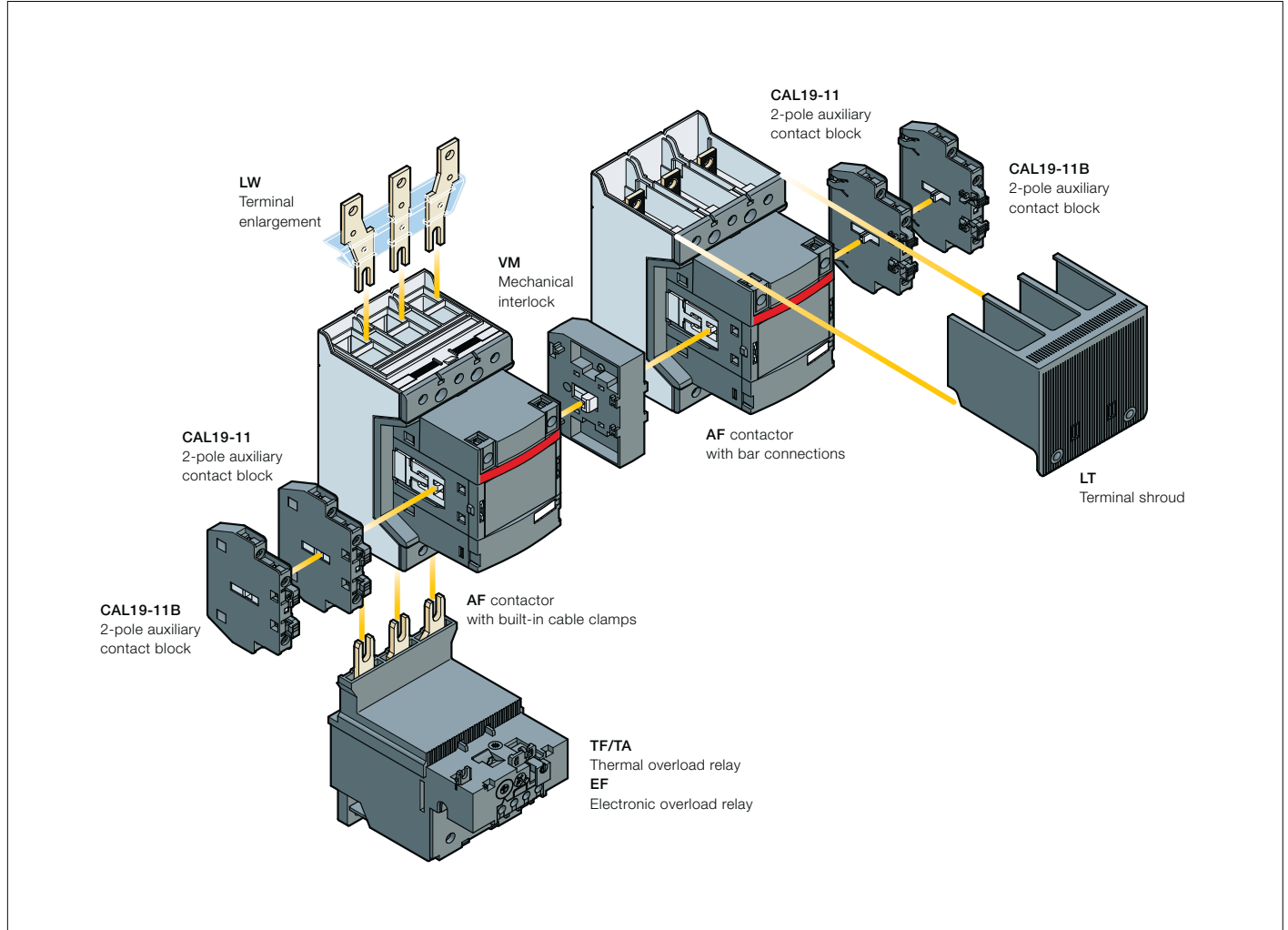

Main accessory fitting details

Contactor types	Main poles	Available auxiliary contacts	Side-mounted accessories		
			Auxiliary contact blocks		Mechanical interlock units (between two contactors)
			CAL19-11 (3)	CAL19-11B (3)	
AF116 ... AF370	3	0 0 0	2 x CAL19-11	+ 2 x CAL19-11B	-
AF116 ... AF370	3	0 0 0	2 x CAL19-11 (1)	+ 2 x CAL19-11B (1)	+ VM... (2)

(1) Total number of auxiliary contact blocks for the two contactors.

(2) Interlock type, according to the contactor ratings (see "Accessories").

(3) The CEL19 auxiliary contact blocks can replace the CAL19-11 and CAL19-11B. Though, no auxiliary contact block can be mounted outside the CEL19.

Overload relays fitting details (1)

Contactor types	Thermal overload relays	Electronic overload relays
AF116 ... AF140	TF140DU (66...142 A)	EF146 (54...150 A)
AF146	-	EF146 (54...150 A)
AF190, AF205	TA200DU (66...200 A)	EF205 (63...210 A)
AF265 ... AF370	-	EF370 (115...380 A)

The addition of a thermal or electronic overload relay on the contactor does not prevent fitting of many other accessories as shown in "Main accessory fitting details" table.

(1) Direct mounting - No kit required.

AF116 ... AF370 3-pole contactors

Main accessories



1SFC101071V0001

CAL19-11



1SFC101035V0001

VM19



1SFC101041V0001

LT370-30C



1SFC101049V0001

LX140

Ordering details (1)

For contactors	Auxiliary contacts	Type	Order code	Pkg qty	Weight (1 pce)
					kg

Side-mounted instantaneous auxiliary contact blocks

AF116 ... AF370	1	1	CAL19-11	1SFN010820R1011	2	0.050
	1	1	CAL19-11B	1SFN010820R3311	2	0.050

Mechanical interlock unit

AF116 ... AF370		VM19	1SFN030300R1000	1	0.054
AF116 ... AF146 and AF190, AF205		VM140/190	1SFN034403R1000	1	0.088
AF190, AF205 and AF265 ... AF370		VM205/265	1SFN035203R1000	1	0.090

Terminal shrouds

AF116 ... AF146, with compression lugs		LT140-30L	1SFN124203R1000	2	0.070
AF190, AF205, with cable clamps		LT205-30C	1SFN124801R1000	2	0.050
AF190, AF205, with compression lugs		LT205-30L	1SFN124803R1000	2	0.220
AF190, AF205, with shorting bar or between contactor and TOL/EOL in DOL-starters		LT205-30Y	1SFN124804R1000	1	0.050
AF265 ... AF370, with cable clamps		LT370-30C	1SFN125401R1000	2	0.035
AF265 ... AF370, with compression lugs		LT370-30L	1SFN125403R1000	2	0.280
AF265 ... AF370, with shorting bar or between contactor and TOL/EOL in DOL-starters		LT370-30Y	1SFN125404R1000	1	0.075
AF265 ... AF370, for use with extending cable clamps, ATK300/2 and OZXB4		LT370-30D	1SFN125406R1000	1	0.150

For contactors	Dimensions		Type	Order code	Pkg qty	Weight (1 pce)
	hole Ø mm	bar mm				kg

Terminal enlargements

AF116 ... AF146	6.5	13 x 3	LW140	1SFN074207R1000	1	0.115
AF190 ... AF205	10.5	17.5 x 5	LW205	1SFN074807R1000	1	0.260
AF265 ... AF370	10.5	20 x 5	LW370	1SFN075407R1000	1	0.340

Terminal extension

AF116 ... AF146	6.5	13 x 3	LX140	1SFN074210R1000	1	0.072
AF190 ... AF205	8.5	17.5 x 5	LX205	1SFN074810R1000	1	0.180
AF265 ... AF370	10.5	20 x 5	LX370	1SFN075410R1000	1	0.234

(1) For more information, refer to "Accessories" section.

AF116 ... AF146 3-pole contactors

55 to 75 kW

AC / DC operated with 1 N.O. + 1 N.C. auxiliary contacts



AF146-30-11

1SFC101001V0001



AF146-30-11B

1SFC101008V0001

Description

AF116 ... AF146 contactors are mainly used for controlling 3-phase motors and power circuits up to 690 V AC, AF146 up to 1000 V AC and AF116 ... AF146 up to 260 V DC. These contactors are of the block type design with 3 main poles.

- control circuit: AC or DC operated with electronic coil interface accepting a wide control voltage range (e.g. 100...250 V AC and DC), only 4 coils to cover control voltages between 24...500 V 50/60 Hz and 20...500 V DC
- can manage large control voltage variations
- reduced panel energy consumption
- very distinct closing and opening
- can withstand short voltage dips and voltage sags (SEMI F47 conditions of use on request).
- built-in surge suppression
- add-on auxiliary contact blocks for side mounting and a wide range of accessories.

Ordering details

IEC	UL / CSA	Rated control circuit voltage	Auxiliary contacts fitted	Type (1)	Order code	Weight
Rated operational power	3-phase motor rating	Uc min. ... Uc max.				Pkg (1 pce)
current	480 V	V 50/60 Hz; V DC				kg
400 V AC-3	AC-1					
kW	hp	A				

For connection with built-in cable clamps

Rated power (kW)	Rated current (A)	3-phase motor rating (hp)	General use rating (A)	Uc min. (V)	Uc max. (V)	Auxiliary contacts	Type	Order code	Weight (kg)
55	160	75	160	24...60	20...60	1 1	AF116-30-11-11	1SFL427001R1111	1.750
				48...130	48...130	1 1	AF116-30-11-12	1SFL427001R1211	1.750
				100...250	100...250	1 1	AF116-30-11-13	1SFL427001R1311	1.750
				250...500	250...500	1 1	AF116-30-11-14	1SFL427001R1411	1.750
75	200	100	200	24...60	20...60	1 1	AF140-30-11-11	1SFL447001R1111	1.750
				48...130	48...130	1 1	AF140-30-11-12	1SFL447001R1211	1.750
				100...250	100...250	1 1	AF140-30-11-13	1SFL447001R1311	1.750
				250...500	250...500	1 1	AF140-30-11-14	1SFL447001R1411	1.750
75	225	100	200	24...60	20...60	1 1	AF146-30-11-11	1SFL467001R1111	1.750
				48...130	48...130	1 1	AF146-30-11-12	1SFL467001R1211	1.750
				100...250	100...250	1 1	AF146-30-11-13	1SFL467001R1311	1.750
				250...500	250...500	1 1	AF146-30-11-14	1SFL467001R1411	1.750

With bar connections

Rated power (kW)	Rated current (A)	3-phase motor rating (hp)	General use rating (A)	Uc min. (V)	Uc max. (V)	Auxiliary contacts	Type	Order code	Weight (kg)
55	160	75	160	24...60	20...60	1 1	AF116-30-11B-11	1SFL427002R1111	1.500
				48...130	48...130	1 1	AF116-30-11B-12	1SFL427002R1211	1.500
				100...250	100...250	1 1	AF116-30-11B-13	1SFL427002R1311	1.500
				250...500	250...500	1 1	AF116-30-11B-14	1SFL427002R1411	1.500
75	200	100	200	24...60	20...60	1 1	AF140-30-11B-11	1SFL447002R1111	1.500
				48...130	48...130	1 1	AF140-30-11B-12	1SFL447002R1211	1.500
				100...250	100...250	1 1	AF140-30-11B-13	1SFL447002R1311	1.500
				250...500	250...500	1 1	AF140-30-11B-14	1SFL447002R1411	1.500
75	225	100	200	24...60	20...60	1 1	AF146-30-11B-11	1SFL467002R1111	1.500
				48...130	48...130	1 1	AF146-30-11B-12	1SFL467002R1211	1.500
				100...250	100...250	1 1	AF146-30-11B-13	1SFL467002R1311	1.500
				250...500	250...500	1 1	AF146-30-11B-14	1SFL467002R1411	1.500

(1) For other auxiliary contacts arrangements, please contact your ABB local sales organization.

Main dimensions mm, inches

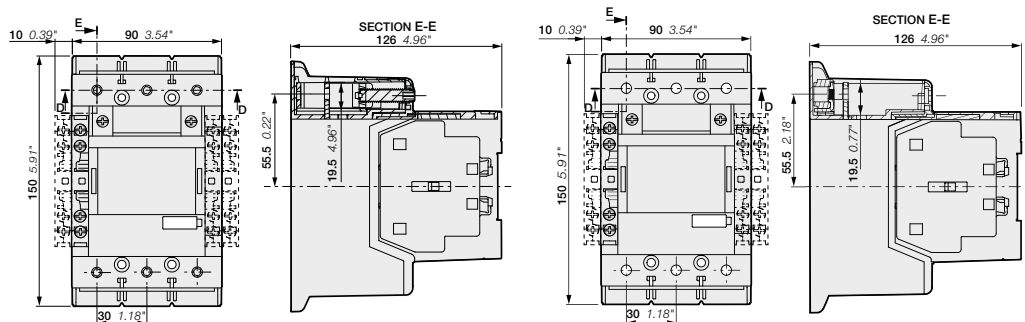

AF116, AF140, AF146-30-11

AF116, AF140, AF146-30-11B

AF116 ... AF146 3-pole contactors with built-in PLC interface

55 to 75 kW

AC / DC operated with 1 N.O. + 1 N.C. auxiliary contacts



AF146-30-11



AF146-30-11B

Description

AF116 ... AF140 contactors are mainly used for controlling 3-phase motors and power circuits up to 690 V AC, AF146 up to 1000 V AC and AF116 ... AF146 up to 260 V DC. These contactors are of the block type design with 3 main poles.

- control circuit: AC or DC operated with electronic coil interface accepting a wide control voltage range (e.g. 100...250 V AC and DC), only 2 coils to cover control voltages between 100...500 V 50/60 Hz and 100...500 V DC
- can manage large control voltage variations
- reduced panel energy consumption
- very distinct closing and opening
- can withstand short voltage dips and voltage sags (SEMI F47 conditions of use on request).
- built-in surge suppression
- add-on auxiliary contact blocks for side mounting and a wide range of accessories.

Ordering details

IEC		UL / CSA		Rated control circuit voltage		Auxiliary contacts fitted	Type (1)	Order code	Weight
Rated power	operational current $\theta \leq 40^\circ\text{C}$	3-phase motor rating	General use rating	Uc min. ...	Uc max.				Pkg (1 pce)
kW	A	hp	A	V 50/60 Hz	V DC				kg
400 V	AC-3	AC-1							

For connection with built-in cable clamps

55	160	75	160	100...250	100...250	1	1	AF116-30-11-33	1SFL427001R3311	1.750
				250...500	250...500	1	1	AF116-30-11-34	1SFL427001R3411	1.750
75	200	100	200	100...250	100...250	1	1	AF140-30-11-33	1SFL447001R3311	1.750
				250...500	250...500	1	1	AF140-30-11-34	1SFL447001R3411	1.750
75	225	100	200	100...250	100...250	1	1	AF146-30-11-33	1SFL467001R3311	1.750
				250...500	250...500	1	1	AF146-30-11-34	1SFL467001R3411	1.750

With bar connections

55	160	75	160	100...250	100...250	1	1	AF116-30-11B-33	1SFL427002R3311	1.500
				250...500	250...500	1	1	AF116-30-11B-34	1SFL427002R3411	1.500
75	200	100	200	100...250	100...250	1	1	AF140-30-11B-33	1SFL447002R3311	1.500
				250...500	250...500	1	1	AF140-30-11B-34	1SFL447002R3411	1.500
75	225	100	200	100...250	100...250	1	1	AF146-30-11B-33	1SFL467002R3311	1.500
				250...500	250...500	1	1	AF146-30-11B-34	1SFL467002R3411	1.500

(1) For other auxiliary contacts arrangements, please contact your ABB local sales organization.

AF116 ... AF146 are equipped with low voltage inputs for control, for example by a PLC.

Control inputs

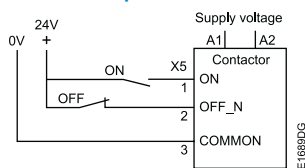

Main dimensions mm, inches

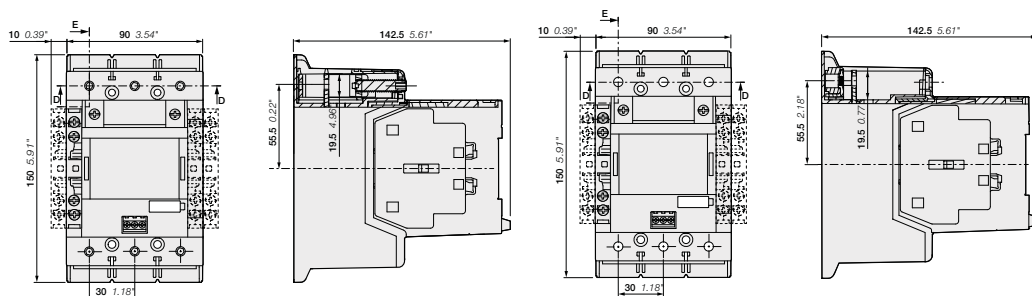

AF116, AF140, AF146-30-11

AF116, AF140, AF146-30-11B

AF190 ... AF370 3-pole contactors

90 to 200 kW

AC / DC operated with 1 N.O. + 1 N.C. auxiliary contacts



AF205-30-11

1SFC101013W0001



AF370-30-11

1SFC101018V0001

Description

AF190 ... AF370 contactors are mainly used for controlling 3-phase motors and power circuits up to 1000 V AC and up to 340 V DC. These contactors are of the block type design with 3 main poles.

- control circuit: AC or DC operated with electronic coil interface accepting a wide control voltage range (e.g. 100...250 V AC and DC), only 4 coils to cover control voltages between 24...500 V 50/60 Hz and 20...500 V DC
 - can manage large control voltage variations
 - reduced panel energy consumption
 - very distinct closing and opening
 - can withstand short voltage dips and voltage sags (SEMI F47 conditions of use on request).
- built-in surge suppression
- add-on auxiliary contact blocks for side mounting and a wide range of accessories.

Ordering details

IEC		UL / CSA		Rated control circuit voltage		Auxiliary contacts fitted		Type (1)	Order code	Weight
Rated operational power	current $\theta \leq 40^\circ\text{C}$	3-phase motor rating	General use rating	Uc min. ... Uc max.						Pkg (1 pce)
400 V AC-3	AC-1	480 V	600 V AC	V 50/60 Hz: V DC						kg
kW	A	hp	A							
90	275	125	250	24...60	20...60	1	1	AF190-30-11-11	1SFL487002R1111	3,000
				48...130	48...130	1	1	AF190-30-11-12	1SFL487002R1211	3,000
				100...250	100...250	1	1	AF190-30-11-13	1SFL487002R1311	3,000
				250...500	250...500	1	1	AF190-30-11-14	1SFL487002R1411	3,000
110	350	150	300	24...60	20...60	1	1	AF205-30-11-11	1SFL527002R1111	3,000
				48...130	48...130	1	1	AF205-30-11-12	1SFL527002R1211	3,000
				100...250	100...250	1	1	AF205-30-11-13	1SFL527002R1311	3,000
				250...500	250...500	1	1	AF205-30-11-14	1SFL527002R1411	3,000
132	400	200	350	24...60	20...60	1	1	AF265-30-11-11	1SFL547002R1111	4,640
				48...130	48...130	1	1	AF265-30-11-12	1SFL547002R1211	4,640
				100...250	100...250	1	1	AF265-30-11-13	1SFL547002R1311	4,640
				250...500	250...500	1	1	AF265-30-11-14	1SFL547002R1411	4,640
160	500	250	400	24...60	20...60	1	1	AF305-30-11-11	1SFL587002R1111	4,640
				48...130	48...130	1	1	AF305-30-11-12	1SFL587002R1211	4,640
				100...250	100...250	1	1	AF305-30-11-13	1SFL587002R1311	4,640
				250...500	250...500	1	1	AF305-30-11-14	1SFL587002R1411	4,640
200	600	300	520	24...60	20...60	1	1	AF370-30-11-11	1SFL607002R1111	4,640
				48...130	48...130	1	1	AF370-30-11-12	1SFL607002R1211	4,640
				100...250	100...250	1	1	AF370-30-11-13	1SFL607002R1311	4,640
				250...500	250...500	1	1	AF370-30-11-14	1SFL607002R1411	4,640

(1) For other auxiliary contacts arrangements, please contact your ABB local sales organization.

Main dimensions mm, inches

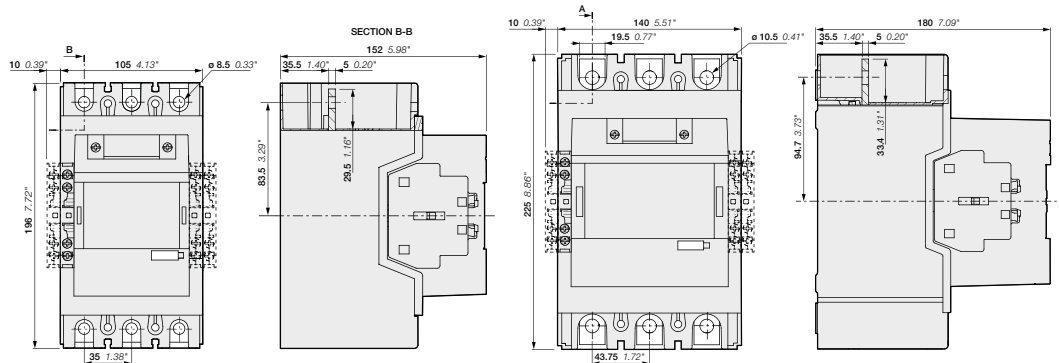

AF190, AF205

AF265, AF305, AF370

1SFC101091C0201 - Rev. E

AF190 ... AF370 3-pole contactors with built-in PLC interface

90 to 200 kW

AC / DC operated with 1 N.O. + 1 N.C. auxiliary contacts



1SFC101163W0001

AF205-30-11



1SFC101163W0001

AF370-30-11

Description

AF190 ... AF370 contactors are mainly used for controlling 3-phase motors and power circuits up to 1000 V AC and up to 340 V DC. These contactors are of the block type design with 3 main poles.

- control circuit: AC or DC operated with electronic coil interface accepting a wide control voltage range (e.g. 100...250 V AC and DC), only 2 coils to cover control voltages between 100...500 V 50/60 Hz and 100...500 V DC
- can manage large control voltage variations
- reduced panel energy consumption
- very distinct closing and opening
- can withstand short voltage dips and voltage sags (SEMI F47 conditions of use on request).
- built-in surge suppression
- add-on auxiliary contact blocks for side mounting and a wide range of accessories.

Ordering details

IEC		UL / CSA		Rated control circuit voltage		Auxiliary contacts fitted		Type (1)	Order code	Weight
Rated operational power	current $\theta \leq 40^\circ\text{C}$	3-phase motor rating	General use rating	Uc min. ... Uc max.		Y Y				Pkg (1 pce)
400 V AC-3	AC-1	hp	A	V 50/60 Hz	V DC					kg
90	275	125	250	100...250	100...250	1	1	AF190-30-11-33	1SFL487002R3311	3.000
				250...500	250...500	1	1	AF190-30-11-34	1SFL487002R3411	3.000
110	350	150	300	100...250	100...250	1	1	AF205-30-11-33	1SFL527002R3311	3.000
				250...500	250...500	1	1	AF205-30-11-34	1SFL527002R3411	3.000
132	400	200	350	100...250	100...250	1	1	AF265-30-11-33	1SFL547002R3311	4.640
				250...500	250...500	1	1	AF265-30-11-34	1SFL547002R3411	4.640
160	500	250	400	100...250	100...250	1	1	AF305-30-11-33	1SFL587002R3311	4.640
				250...500	250...500	1	1	AF305-30-11-34	1SFL587002R3411	4.640
200	600	300	520	100...250	100...250	1	1	AF370-30-11-33	1SFL607002R3311	4.640
				250...500	250...500	1	1	AF370-30-11-34	1SFL607002R3411	4.640

(1) For other auxiliary contacts arrangements, please contact your ABB local sales organization.

AF190 ... AF370 are equipped with low voltage inputs for control, for example by a PLC.

Control inputs

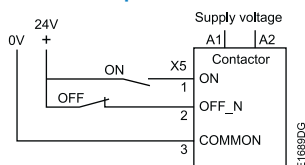

Main dimensions mm, inches

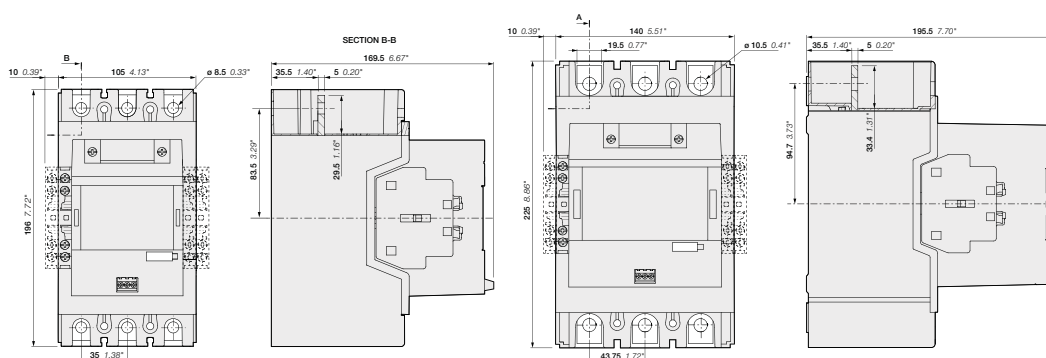

AF190, AF205

AF265, AF305, AF370

1SFC101167C0201 - Rev. A

AF116 ... AF370 3-pole contactors with 1 N.O. + 1 N.C. auxiliary contacts Main accessories

Main accessories (other accessories available)

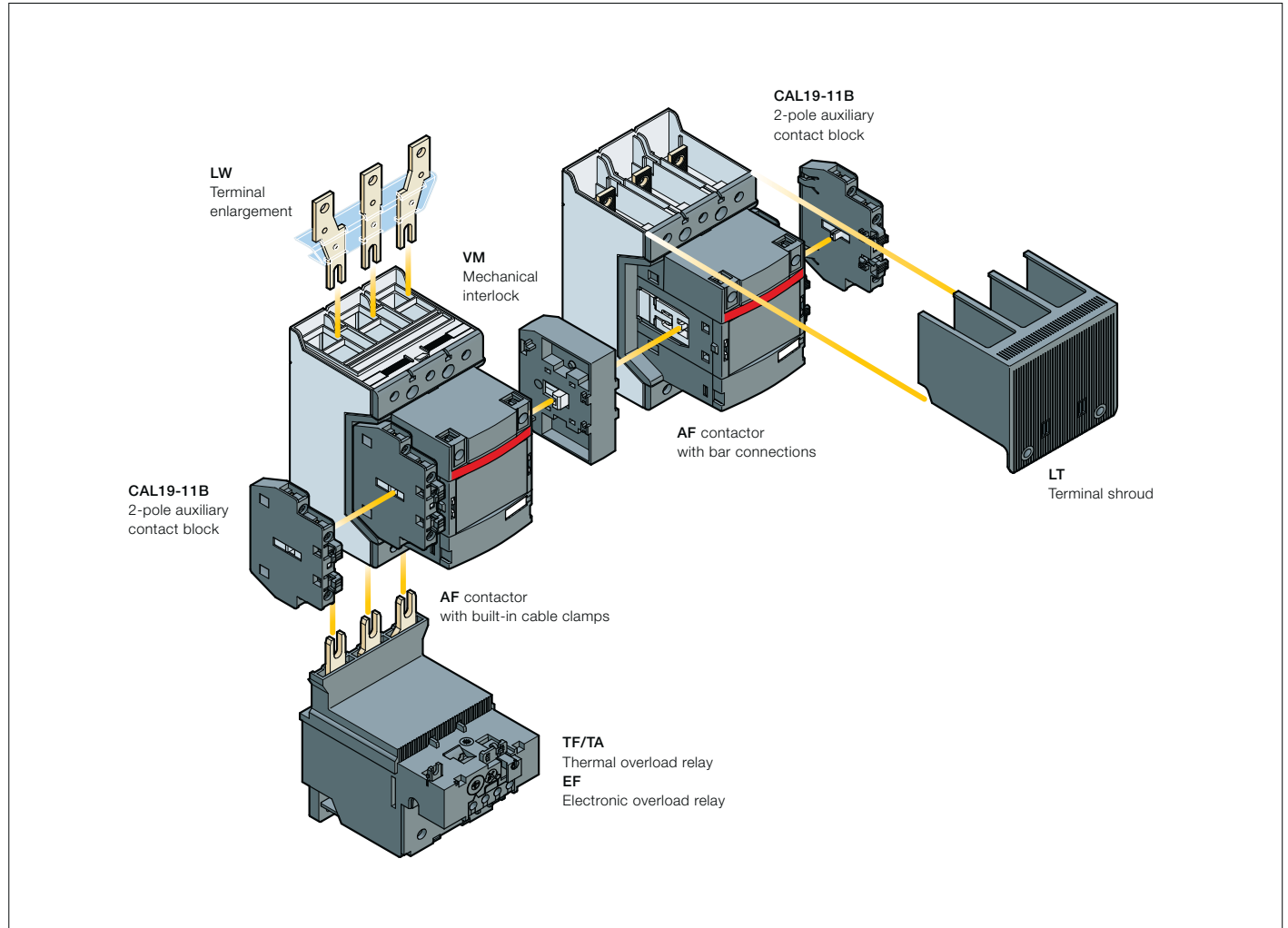

Main accessory fitting details

Contactor types	Main poles	Available auxiliary contacts	Side-mounted accessories		
			Auxiliary contact blocks		Mechanical interlock units (between two contactors)
			CAL19-11 (3)	CAL19-11B (3)	
AF116 ... AF370	3	0 1 1	1 x CAL19-11	+ 2 x CAL19-11B	-
AF116 ... AF370	3	0 1 1	-	+ 2 x CAL19-11B (1)	+ VM... (2)

(1) Total number of auxiliary contact blocks for the two contactors.

(2) Interlock type, according to the contactor ratings (see "Accessories").

(3) The CEL19 auxiliary contact blocks can replace the CAL19-11 and CAL19-11B. Though, no auxiliary contact block can be mounted outside the CEL19.

Overload relays fitting details (1)

Contactor types	Thermal overload relays	Electronic overload relays
AF116 ... AF140	TF140DU (66...142 A)	EF146 (54...150 A)
AF146	-	EF146 (54...150 A)
AF190, AF205	TA200DU (66...200 A)	EF205 (63...210 A)
AF265 ... AF370	-	EF370 (115...380 A)

The addition of a thermal or electronic overload relay on the contactor does not prevent fitting of many other accessories as shown in "Main accessory fitting details" table.

(1) Direct mounting - No kit required.

AF116 ... AF370 3-pole contactors with 1 N.O. + 1 N.C. auxiliary contacts

Main accessories



1SFC101071V0001

CAL19-11



1SFC101035V0001

VM19



1SFC101041V0001

LT370-30C



1SFC101049V0001

LX140

Ordering details (1)

For contactors	Auxiliary contacts	Type	Order code	Pkg qty	Weight (1 pce)
					kg

Side-mounted instantaneous auxiliary contact blocks

AF116 ... AF370	1	1	CAL19-11	1SFN010820R1011	2	0.050
	1	1	CAL19-11B	1SFN010820R3311	2	0.050

Mechanical interlock unit

AF116 ... AF370		VM19	1SFN030300R1000	1	0.054
AF116 ... AF146 and AF190, AF205		VM140/190	1SFN034403R1000	1	0.088
AF190, AF205 and AF265 ... AF370		VM205/265	1SFN035203R1000	1	0.090

Terminal shrouds

AF116 ... AF146, with compression lugs		LT140-30L	1SFN124203R1000	2	0.070
AF190, AF205, with cable clamps		LT205-30C	1SFN124801R1000	2	0.050
AF190, AF205, with compression lugs		LT205-30L	1SFN124803R1000	2	0.220
AF190, AF205, with shorting bar or between contactor and TOL/EOL in DOL-starters		LT205-30Y	1SFN124804R1000	1	0.050
AF265 ... AF370, with cable clamps		LT370-30C	1SFN125401R1000	2	0.035
AF265 ... AF370, with compression lugs		LT370-30L	1SFN125403R1000	2	0.280
AF265 ... AF370, with shorting bar or between contactor and TOL/EOL in DOL-starters		LT370-30Y	1SFN125404R1000	1	0.075
AF265 ... AF370, for use with extending cable clamps, ATK300/2 and OZXB4		LT370-30D	1SFN125406R1000	1	0.150

For contactors	Dimensions		Type	Order code	Pkg qty	Weight (1 pce)
	hole Ø mm	bar mm				kg

Terminal enlargements

AF116...AF146	6.5	13 x 3	LW140	1SFN074207R1000	1	0.115
AF190...AF205	10.5	17.5 x 5	LW205	1SFN074807R1000	1	0.260
AF265...AF370	10.5	20 x 5	LW370	1SFN075407R1000	1	0.340

Terminal extension

AF116...AF146	6.5	13 x 3	LX140	1SFN074210R1000	1	0.072
AF190...AF250	8.5	17.5 x 5	LX205	1SFN074810R1000	1	0.180
AF265...AF370	10.5	20 x 5	LX370	1SFN075410R1000	1	0.234

(1) For more information, refer to main catalog "Accessories" section.

AF400 ... AF750 3-pole contactors

200 to 400 kW

AC / DC operated with 1 N.O. + 1 N.C. auxiliary contacts



AF460-30-11

1SFC101025V0001



AF750-30-11

1SFC101025V0001

Description

AF400 ... AF750 contactors are mainly used for controlling 3-phase motors and power circuits up to 1000 V AC or 600 V DC (2). These contactors are of the block type design with 3 main poles.

- control circuit: AC or DC operated with electronic coil interface accepting a wide control voltage range (e.g. 100...250 V AC and DC), only 4 coils to cover control voltages between 48...500 V 50/60 Hz and 24...500 V DC
- can manage large control voltage variations
- reduced panel energy consumption
- very distinct closing and opening
- can withstand short voltage dips and voltages sags (SEMI F47 conditions of use on request).
- built-in surge suppression
- add-on auxiliary contact blocks for side mounting and a wide range of accessories.

Ordering details

IEC	Rated operational power 400 V AC-3 kW	Rated operational current $\theta \leq 40^\circ\text{C}$ 690 V AC-1 A	UL/CSA 3-phase motor rating 480 V hp	General use rating 600 V AC A	Rated control circuit voltage Uc min. ... Uc max.		Auxiliary contacts fitted	Type	Order code	Weight kg
					V 50/60 Hz	V DC				
200	600	350	550	-	24...60	24...60	1 1	AF400-30-11	1SFL577001R6811 (1)	12.000
					48...130	48...130	1 1	AF400-30-11	1SFL577001R6911	12.000
					100...250	100...250	1 1	AF400-30-11	1SFL577001R7011	12.000
					250...500	250...500	1 1	AF400-30-11	1SFL577001R7111	12.000
250	700	400	650	-	24...60	24...60	1 1	AF460-30-11	1SFL597001R6811 (1)	12.000
					48...130	48...130	1 1	AF460-30-11	1SFL597001R6911	12.000
					100...250	100...250	1 1	AF460-30-11	1SFL597001R7011	12.000
					250...500	250...500	1 1	AF460-30-11	1SFL597001R7111	12.000
315	800	500	750	-	24...60	24...60	1 1	AF580-30-11	1SFL617001R6811 (1)	15.000
					48...130	48...130	1 1	AF580-30-11	1SFL617001R6911	15.000
					100...250	100...250	1 1	AF580-30-11	1SFL617001R7011	15.000
					250...500	250...500	1 1	AF580-30-11	1SFL617001R7111	15.000
400	1050	600	900	-	24...60	24...60	1 1	AF750-30-11	1SFL637001R6811 (1)	15.000
					48...130	48...130	1 1	AF750-30-11	1SFL637001R6911	15.000
					100...250	100...250	1 1	AF750-30-11	1SFL637001R7011	15.000
					250...500	250...500	1 1	AF750-30-11	1SFL637001R7111	15.000

(1) The connection polarities indicated close to the coil terminals must be respected: A1 for the positive pole and A2 for the negative pole.
(2) Up to 850 V DC for AF580, AF750.

AF400 ... AF750 are equipped with low voltage inputs for control, for example by a PLC.

Control inputs

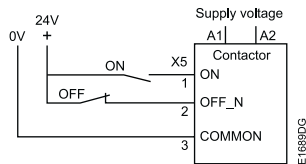

Main dimensions mm, inches

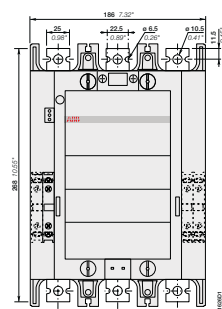

AF400, AF460

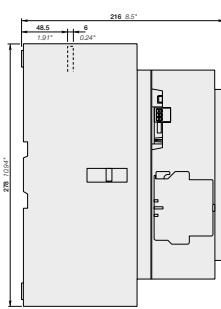

AF580, AF750

AF1250 ... AF2650 3-pole contactors

475 to 560 kW and 1260 to 2650 A AC-1

AC / DC operated with 1 N.O. + 1 N.C. auxiliary contacts



AF1250-30-11

1SFC101027V0001



AF2650-30-11

1SFC101031V0001

Description

AF1250 ... AF2050 contactors are mainly used for controlling power circuits up to 1000 V AC or 850 V DC, AF2650 for controlling power up to 1000 V AC. These contactors are of the block type design with 3 main poles.

- control circuit: AC or DC operated with electronic coil interface accepting a wide control voltage range (e.g. 100...250 V AC and DC)
- only 4 coils for AF1250 to cover control voltages between 48...500 V 50/60 Hz and 24...500 V DC
- only 1 coil for AF1350 ... AF2650 to cover control voltages between 100...250 V 50/60 Hz and 100...250 V DC
- can manage large control voltage variations
- reduced panel energy consumption
- very distinct closing and opening
- can withstand short voltage dips and voltages sags (SEMI F47 conditions of use on request).
- built-in surge suppression
- add-on auxiliary contact blocks for side mounting and a wide range of accessories.

Ordering details

IEC		UL/CSA		Rated control circuit voltage U _c		Auxiliary contacts fitted		Type	Order code	Weight
Rated operational power	Rated current I _n at θ ≤ 40 °C	3-phase motor rating	General use rating	(1)		1 1				Pkg (1 pce)
kW	A	hp	A	V 50/60 Hz	V DC	1 1				kg
-	1260	-	1210	-	24...60	1	1	AF1250-30-11	1SFL647001R6811 (1)	16.000
				48...130	48...130	1	1	AF1250-30-11	1SFL647001R6911	16.000
				100...250	100...250	1	1	AF1250-30-11	1SFL647001R7011	16.000
				250...500	250...500	1	1	AF1250-30-11	1SFL647001R7111	16.000
475	1350	800	1350	100...250	100...250	1	1	AF1350-30-11	1SFL657001R7011	34.000
560	1650	900	1650	100...250	100...250	1	1	AF1650-30-11	1SFL677001R7011	35.000
-	2050	-	2100	100...250	100...250	1	1	AF2050-30-11	1SFL707001R7011	35.000
-	2650	-	2700	100...250	100...250	1	1	AF2650-30-11	1SFL667001R7011	45.000

(1) The connection polarities indicated close to the coil terminals must be respected: A1 for the positive pole and A2 for the negative pole.
 (2) AF2650: Maximum operational voltage = 1000 V according to UL / CSA.

AF1250 ... AF2650 are equipped with low voltage inputs for control, for example by a PLC

Control inputs

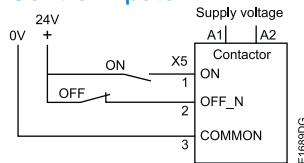

	AF1350, AF1650, AF2050	AF2650
A	392 mm / 15.43"	422 mm / 16.61"
B	47 mm / 1.85"	53 mm / 2.09"
C	10 mm / 0.39"	25 mm / 0.98"

Main dimensions mm, inches

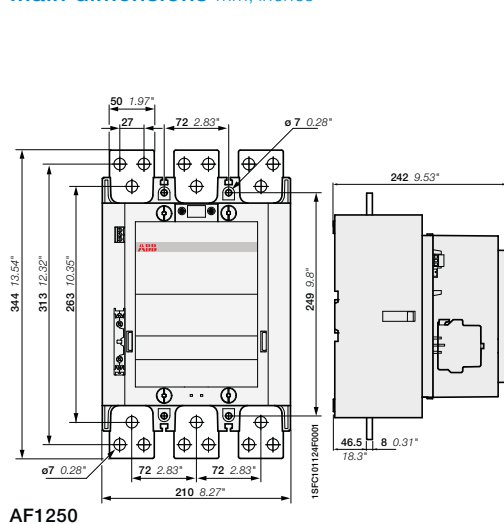

AF1250

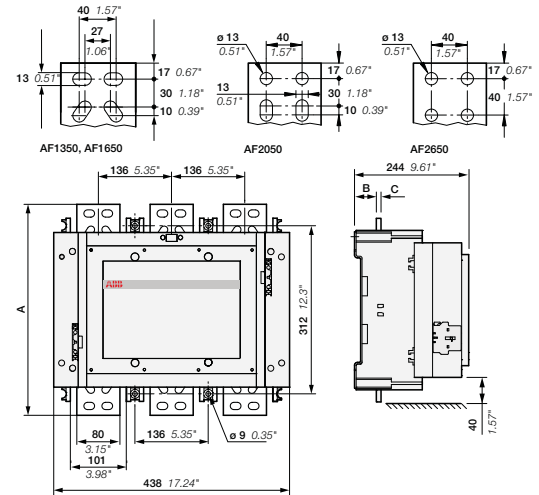

AF1350, AF1650, AF2050, AF2650

AF1350..T ... AF2650..T 3-pole contactors with built-in LVRT 475 to 560 kW and 1350 to 2650 A AC-1 AC operated with 1 N.O. + 1 N.C. auxiliary contacts



AF2650-30T-11

1SFC101076W0001

Description

AF1350T .. AF2050T contactors are designed to meet the Low Voltage Ride Through requirements for grid connections withstand voltage drop-outs up to 1 sec without opening. These contactors are often used in grid connected applications where the demand of non interrupted power is required. When controlled through built-in PLC connection the contactor is operated directly without delay function.

- Control circuit: AC or DC operated with electronic coil interface
- can withstand voltage drop-outs according to Low Voltage Ride Through requirements
- equipped with low voltage inputs for direct control by a PLC
- distinct closing and opening
- add-on auxiliary contact blocks for side mounting and a wide range of accessories.

Ordering details

IEC		UL/CSA		Rated control circuit voltage Uc	Auxiliary contacts fitted	Type	Order code	Weight
Rated operational power	current $\theta \leq 40^\circ\text{C}$	3-phase motor rating	General use rating					
400 V AC-3	690 V AC-1	480 V	600 V AC	V 50/60 Hz				kg
kW	A	hp	A					
475	1350	800	1350	220 ... 240	1 1	AF1350-30T-11 (1)	1SFL657001R9101	34.000
560	1650	900	1650	220 ... 240	1 1	AF1650-30T-11 (1)	1SFL677001R9101	35.000
-	2050	-	2100	220 ... 240	1 1	AF2050-30T-11 (1)	1SFL707001R9101	35.000
-	2650	-	2700	220 ... 240	1 1	AF2650-30T-11 (1)	1SFL667001R9101	45.000

(1) Types -00 and -22 on request.

Control inputs

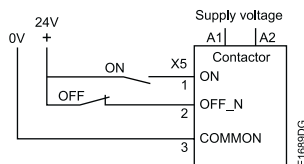

Main dimensions mm, inches

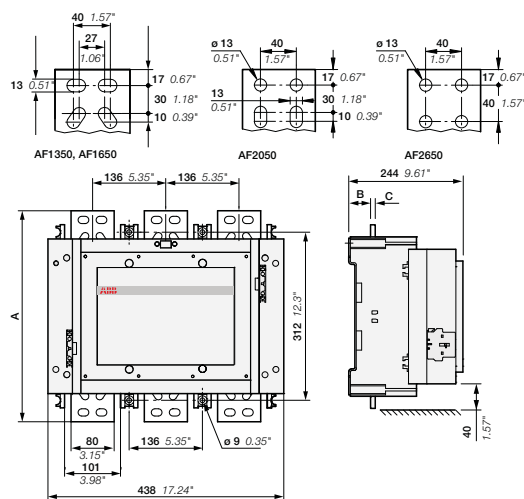

AF1350-30T-11, AF1650-30T-11, AF2050-30T-11, AF2650-30T-11

	AF1350, AF1650, AF2050	AF2650
A	392 mm / 15.43"	422 mm / 16.61"
B	47 mm / 1.85"	53 mm / 2.09"
C	10 mm / 0.39"	25 mm / 0.98"

1SFC101076D0201

AF400 ... AF2650 3-pole contactors with 1 N.O. + 1 N.C. auxiliary contacts

Main accessories

Main accessories (other accessories available)

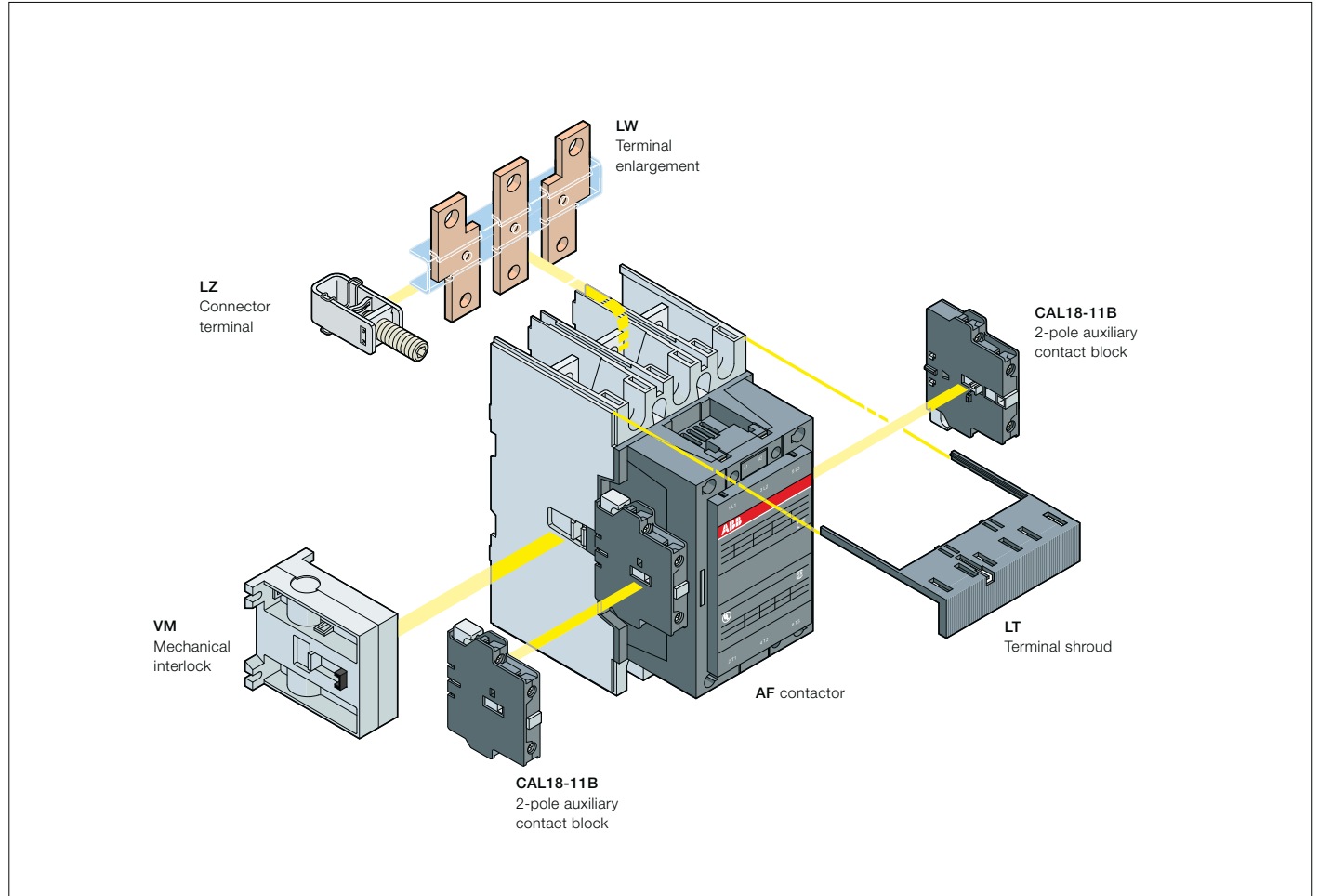

Main accessory fitting details

Contactor types	Main poles	Available auxiliary contacts	Side-mounted accessories		
			Auxiliary contact blocks		Mechanical interlock units (between two contactors)
			CAL18-11	CAL18-11B (3)	

Contactors + auxiliary contact blocks

AF400 ... AF2650	3	0	1	1	1 x CAL18-11	+	2 x CAL18-11B	-
------------------	---	---	---	---	--------------	---	---------------	---

Contactors with mechanical interlocking + auxiliary contact blocks

AF400 ... AF2650	3	0	1	1	2 x CAL18-11 (1)	+	4 x CAL18-11B (1)	+	VM...H (2)
------------------	---	---	---	---	------------------	---	-------------------	---	------------

(1) Total number of auxiliary contact blocks for the two contactors.

(2) Interlock type, according to the contactor ratings (see "Accessories").

(3) The CEL18-.. auxiliary contact blocks can replace the CAL18-11 and CAL18-11B. Though, no auxiliary contact block can be mounted outside the CEL18-..

Overload relays fitting details

Contactor types	Thermal overload relays		Electronic overload relays	
	AF400, AF460	-	-	EF460 (150...500 A) (1)
AF580, AF750	-	-	EF750 (250...800 A) (1)	
AF1350, AF1650	-	-	E1250DU (375...1250 A) (1)	

The addition of a thermal or electronic overload relay on the contactor does not prevent fitting of many other accessories as shown in "Main accessory fitting details" table.

(1) Mounting kit required (see "Motor protection").

AF400 ... AF2650 3-pole contactors with 1 N.O. + 1 N.C. auxiliary contacts Main accessories



CAL18-11

1SFC101082V0001



VM750H

1SFC101084V0001



LT460-AC

1SFC101089V0001

Ordering details (1)

For contactors	Auxiliary contacts	Type	Order code	Pkg qty	Weight (1 pce)
					kg

Side-mounted instantaneous auxiliary contact blocks

AF400 ... AF2650	1	1	CAL18-11	1SFN010720R1011	2	0.050
	1	1	CAL18-11B	1SFN010720R3311	2	0.050

Mechanical interlock unit

AF400 ... AF1250			VM750H	1SFN035700R1000	1	0.200
AF1350 ... AF2650			VM1650H	1SFN036503R1000	1	6.000

Terminal shrouds

AF400, AF460 with connectors			LT460-AC	1SFN125701R1000	2	0.100
AF400, AF460 with lugs			LT460-AL	1SFN125703R1000	2	0.800
AF580 ... AF750 with connectors			LT750-AC	1SFN126101R1000	2	0.120
AF580 ... AF750 with lugs			LT750-AL	1SFN126103R1000	2	0.825

5

For contactors	Dimensions		Type	Order code	Pkg qty	Weight (1 pce)
	hole Ø	bar				kg
	mm	mm				

Terminal enlargements

AF400, AF460	10.5	25 x 5	LW460	1SFN075707R1000	1	0.730
AF580, AF750	13	40 x 6	LW750	1SFN076107R1000	1	1.230
AF1250	13	50 x 10	LW1250	1SFN076407R1000	1	2.000

Terminal extension

AF400, AF460	10.5	25 x 5	LX460	1SFN075710R1000	1	0.500
AF580, AF750	13	40 x 6	LX750	1SFN076110R1000	1	0.850

(1) For more information, refer to main catalog "Accessories" section.

AF09 ... AF38 2-stack 3-pole contactors

4 to 18.5 kW

AC / DC operated



AF09-30-22

1SBC101002V0014



AF26-30-11

1SBC101003V0014



AF26-30-22

1SBC101004V0014

Description

AF09 ... AF38 contactors are mainly used for controlling 3-phase motors and power circuits up to 690 V AC and 220 V DC. These contactors are of the block type design with 3 main poles (1st stack):

- 2nd stack with permanently fixed auxiliary contact block. The built-in auxiliary contact elements are mechanically linked (side-marked symbol) and the N.C. auxiliary contacts are mirror contacts
- control circuit: AC or DC operated with electronic coil interface accepting a wide control voltage range (e.g. 100...250 V AC and DC), only 4 control voltage ranges covering 24...500 V 50/60 Hz and 20...500 V DC
- can manage large control voltage variations
- reduced panel energy consumption
- very distinct closing and opening.
- built-in surge suppression
- add-on auxiliary contact blocks for side mounting and a wide range of accessories.

Ordering details

IEC Rated operational power	UL/CSA 3-phase motor rating 480 V	General use rating 600 V AC	Rated control circuit voltage		Auxiliary contacts fitted	Type (1)	Order code	Weight Pkg (1 pce)					
			V 50/60 Hz	V DC									
400 V AC-3 kW	AC-1 A	hp	A										
				$\theta \leq 40^\circ \text{C}$									
				25	5	25	24...60	-	(2)	2 2	AF09-30-22-41	1SBL137001R4122	0.320
							48...130	48...130		2 2	AF09-30-22-12	1SBL137001R1222	0.320
				100...250	100...250		2 2	AF09-30-22-13	1SBL137001R1322	0.320			
				250...500	250...500		2 2	AF09-30-22-14	1SBL137001R1422	0.360			
5.5	28	7.5	28	24...60	-	(2)	2 2	AF12-30-22-41	1SBL157001R4122	0.320			
				48...130	48...130		2 2	AF12-30-22-12	1SBL157001R1222	0.320			
				100...250	100...250		2 2	AF12-30-22-13	1SBL157001R1322	0.320			
				250...500	250...500		2 2	AF12-30-22-14	1SBL157001R1422	0.360			
7.5	30	10	30	24...60	-	(2)	2 2	AF16-30-22-41	1SBL177001R4122	0.320			
				48...130	48...130		2 2	AF16-30-22-12	1SBL177001R1222	0.320			
				100...250	100...250		2 2	AF16-30-22-13	1SBL177001R1322	0.320			
				250...500	250...500		2 2	AF16-30-22-14	1SBL177001R1422	0.360			
11	45	15	45	24...60	-	(2)	1 1	AF26-30-11-41	1SBL237001R4111	0.350			
							2 2	AF26-30-22-41	1SBL237001R4122	0.360			
				48...130	48...130		1 1	AF26-30-11-12	1SBL237001R1211	0.350			
							2 2	AF26-30-22-12	1SBL237001R1222	0.360			
				100...250	100...250		1 1	AF26-30-11-13	1SBL237001R1311	0.350			
							2 2	AF26-30-22-13	1SBL237001R1322	0.360			
				250...500	250...500		1 1	AF26-30-11-14	1SBL237001R1411	0.390			
							2 2	AF26-30-22-14	1SBL237001R1422	0.400			
15	50	20	50	24...60	-	(2)	1 1	AF30-30-11-41	1SBL277001R4111	0.350			
							2 2	AF30-30-22-41	1SBL277001R4122	0.360			
				48...130	48...130		1 1	AF30-30-11-12	1SBL277001R1211	0.350			
							2 2	AF30-30-22-12	1SBL277001R1222	0.360			
				100...250	100...250		1 1	AF30-30-11-13	1SBL277001R1311	0.350			
							2 2	AF30-30-22-13	1SBL277001R1322	0.360			
				250...500	250...500		1 1	AF30-30-11-14	1SBL277001R1411	0.390			
							2 2	AF30-30-22-14	1SBL277001R1422	0.400			
18.5	50	25	50	24...60	-	(2)	1 1	AF38-30-11-41	1SBL297001R4111	0.350			
							2 2	AF38-30-22-41	1SBL297001R4122	0.360			
				48...130	48...130		1 1	AF38-30-11-12	1SBL297001R1211	0.350			
							2 2	AF38-30-22-12	1SBL297001R1222	0.360			
				100...250	100...250		1 1	AF38-30-11-13	1SBL297001R1311	0.350			
							2 2	AF38-30-22-13	1SBL297001R1322	0.360			
				250...500	250...500		1 1	AF38-30-11-14	1SBL297001R1411	0.390			
							2 2	AF38-30-22-14	1SBL297001R1422	0.400			

(1) For other auxiliary contacts arrangements, please contact your ABB local sales organization.

(2) For 24...60 V 50/60 Hz - 20...60 V DC, use AF..Z-30-...-21.

AF..-30-...-11 not suitable for direct control by PLC-output.

Main dimensions mm, inches

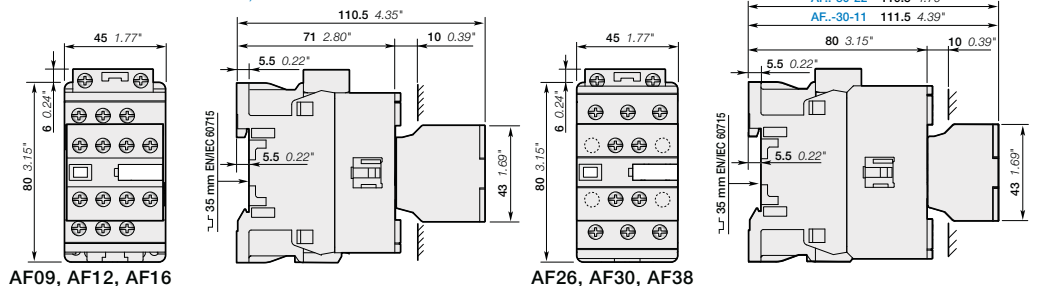

AF09Z ... AF38Z 2-stack 3-pole contactors

4 to 18.5 kW

AC / DC operated - Low consumption



AF09Z-30-22

1SBC101002V0014



AF26Z-30-11

1SBC101003V0014



AF26Z-30-22

1SBC101004V0014

Description

AF09Z ... AF38Z contactors are mainly used for controlling 3-phase motors and power circuits up to 690 V AC and 220 V DC. These contactors are of the block type design with 3 main poles (1st stack):

- 2nd stack with permanently fixed auxiliary contact block. The built-in auxiliary contact elements are mechanically linked (side-marked symbol) and the N.C. auxiliary contacts are mirror contacts
- control circuit: AC or DC operated with electronic coil interface accepting a wide control voltage range (e.g. 100...250 V AC and DC), only 4 control voltage ranges covering 24...250 V 50/60 Hz and 12...250 V DC
- can manage large control voltage variations, allow direct control by PLC-output ≥ 24 V DC 500 mA, reduced panel energy consumption, very distinct closing and opening,
- can withstand short voltage dips and voltage sags (SEMI F47-0706 conditions of use on request).
- built-in surge suppression
- add-on auxiliary contact blocks for side mounting and a wide range of accessories.

Ordering details

IEC Rated operational power kW	Rated operational current A	UL/CSA 3-phase motor rating 480 V hp	General use rating 600 V AC A	Rated control circuit voltage Uc min. ... Uc max.		Auxiliary contacts fitted	Type (1)	Order code	Weight Pkg (1 pce) kg				
				V 50/60 Hz	V DC								
4	25	5	25	-	12...20	2 2	AF09Z-30-22-20	1SBL136001R2022	0.360				
				24...60	20...60	2 2	AF09Z-30-22-21	1SBL136001R2122	0.360				
				48...130	48...130	2 2	AF09Z-30-22-22	1SBL136001R2222	0.360				
				100...250	100...250	2 2	AF09Z-30-22-23	1SBL136001R2322	0.360				
5.5	28	7.5	28	-	12...20	2 2	AF12Z-30-22-20	1SBL156001R2022	0.360				
				24...60	20...60	2 2	AF12Z-30-22-21	1SBL156001R2122	0.360				
				48...130	48...130	2 2	AF12Z-30-22-22	1SBL156001R2222	0.360				
				100...250	100...250	2 2	AF12Z-30-22-23	1SBL156001R2322	0.360				
7.5	30	10	30	-	12...20	2 2	AF16Z-30-22-20	1SBL176001R2022	0.360				
				24...60	20...60	2 2	AF16Z-30-22-21	1SBL176001R2122	0.360				
				48...130	48...130	2 2	AF16Z-30-22-22	1SBL176001R2222	0.360				
				100...250	100...250	2 2	AF16Z-30-22-23	1SBL176001R2322	0.360				
11	45	15	45	-	12...20	1 1	AF26Z-30-11-20	1SBL236001R2011	0.390				
				24...60	20...60	2 2	AF26Z-30-22-20	1SBL236001R2022	0.400				
				24...60	20...60	1 1	AF26Z-30-11-21	1SBL236001R2111	0.390				
				48...130	48...130	2 2	AF26Z-30-22-21	1SBL236001R2122	0.400				
				48...130	48...130	1 1	AF26Z-30-11-22	1SBL236001R2211	0.390				
				100...250	100...250	2 2	AF26Z-30-22-22	1SBL236001R2222	0.400				
				100...250	100...250	1 1	AF26Z-30-11-23	1SBL236001R2311	0.390				
				100...250	100...250	2 2	AF26Z-30-22-23	1SBL236001R2322	0.400				
				15	50	20	50	-	12...20	1 1	AF30Z-30-11-20	1SBL276001R2011	0.390
								24...60	20...60	2 2	AF30Z-30-22-20	1SBL276001R2022	0.400
24...60	20...60	1 1	AF30Z-30-11-21					1SBL276001R2111	0.390				
48...130	48...130	2 2	AF30Z-30-22-21					1SBL276001R2122	0.400				
48...130	48...130	1 1	AF30Z-30-11-22					1SBL276001R2211	0.390				
100...250	100...250	2 2	AF30Z-30-22-22					1SBL276001R2222	0.400				
100...250	100...250	1 1	AF30Z-30-11-23					1SBL276001R2311	0.390				
100...250	100...250	2 2	AF30Z-30-22-23					1SBL276001R2322	0.400				
18.5	50	25	50	-	12...20	1 1	AF38Z-30-11-20	1SBL296001R2011	0.390				
				24...60	20...60	2 2	AF38Z-30-22-20	1SBL296001R2022	0.400				
				24...60	20...60	1 1	AF38Z-30-11-21	1SBL296001R2111	0.390				
				48...130	48...130	2 2	AF38Z-30-22-21	1SBL296001R2122	0.400				
				48...130	48...130	1 1	AF38Z-30-11-22	1SBL296001R2211	0.390				
				100...250	100...250	2 2	AF38Z-30-22-22	1SBL296001R2222	0.400				
				100...250	100...250	1 1	AF38Z-30-11-23	1SBL296001R2311	0.390				
				100...250	100...250	2 2	AF38Z-30-22-23	1SBL296001R2322	0.400				

(1) For other auxiliary contacts arrangements, please contact your ABB local sales organization.

Note: Only AF.Z contactors with DC control voltage 12...20 V DC need to respect the connection polarities indicated close to the coil terminals: A1+ for the positive pole and A2- for the negative pole

Main dimensions mm, inches

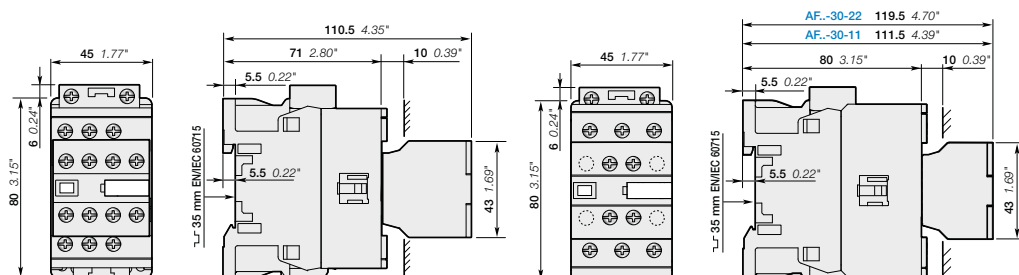

AF09Z, AF12Z, AF16Z

AF26Z, AF30Z, AF38Z

1SBC10137450201 - Rev. B

AF40 ... AF65 2-stack 3-pole contactors

18.5 to 30 kW

AC / DC operated



AF40-30-11

1SBC101005V0014

Description

AF40 ... AF65 contactors are mainly used for controlling 3-phase motors and power circuits up to 690 V AC and 220 V DC. These contactors are of the block type design with 3 main poles (1st stack):

- 2nd stack with permanently fixed auxiliary contact block. The built-in auxiliary contact elements are mechanically linked (side-marked symbol) and the N.C. auxiliary contacts are mirror contacts
- control circuit: AC or DC operated with electronic coil interface accepting a wide control voltage range (e.g. 100...250 V AC and DC), only 4 control voltage ranges covering 24...500 V 50/60 Hz and 20...500 V DC
- can manage large control voltage variations
- reduced panel energy consumption
- very distinct closing and opening.
- built-in surge suppression
- add-on auxiliary contact blocks for side mounting and a wide range of accessories.

Ordering details

IEC	UL / CSA		Rated control circuit voltage Uc min. ... Uc max.	Auxiliary contacts fitted	Type (1)	Order code	Weight Pkg (1 pce)						
	Rated operational power 400 V AC-3 kW	current $\theta \leq 40^\circ\text{C}$ AC-1 A						3-phase motor rating 480 V hp	General use rating 600 V AC A	V 50/60 Hz	V DC	kg	
18.5	70	30	60	24...60	-	1 1	AF40-30-11-41	1SBL347001R4111	1.010				
					2 2	AF40-30-22-41	1SBL347001R4122	1.020					
				24...60	20...60 (2)	1 1	AF40-30-11-11	1SBL347001R1111	1.010				
						2 2	AF40-30-22-11	1SBL347001R1122	1.020				
				48...130	48...130	1 1	AF40-30-11-12	1SBL347001R1211	1.010				
						2 2	AF40-30-22-12	1SBL347001R1222	1.020				
				100...250	100...250	1 1	AF40-30-11-13	1SBL347001R1311	0.990				
						2 2	AF40-30-22-13	1SBL347001R1322	1.000				
				250...500	250...500	1 1	AF40-30-11-14	1SBL347001R1411	0.990				
						2 2	AF40-30-22-14	1SBL347001R1422	1.000				
				22	100	40	80	24...60	-	1 1	AF52-30-11-41	1SBL367001R4111	1.010
									2 2	AF52-30-22-41	1SBL367001R4122	1.020	
24...60	20...60 (2)	1 1	AF52-30-11-11					1SBL367001R1111	1.010				
		2 2	AF52-30-22-11					1SBL367001R1122	1.020				
48...130	48...130	1 1	AF52-30-11-12					1SBL367001R1211	1.010				
		2 2	AF52-30-22-12					1SBL367001R1222	1.020				
100...250	100...250	1 1	AF52-30-11-13					1SBL367001R1311	0.990				
		2 2	AF52-30-22-13					1SBL367001R1322	1.000				
250...500	250...500	1 1	AF52-30-11-14					1SBL367001R1411	0.990				
		2 2	AF52-30-22-14					1SBL367001R1422	1.000				
30	105	50	90					24...60	-	1 1	AF65-30-11-41	1SBL387001R4111	1.010
									2 2	AF65-30-22-41	1SBL387001R4122	1.020	
				24...60	20...60 (2)	1 1	AF65-30-11-11	1SBL387001R1111	1.010				
						2 2	AF65-30-22-11	1SBL387001R1122	1.020				
				48...130	48...130	1 1	AF65-30-11-12	1SBL387001R1211	1.010				
						2 2	AF65-30-22-12	1SBL387001R1222	1.020				
				100...250	100...250	1 1	AF65-30-11-13	1SBL387001R1311	0.990				
						2 2	AF65-30-22-13	1SBL387001R1322	1.000				
				250...500	250...500	1 1	AF65-30-11-14	1SBL387001R1411	0.990				
						2 2	AF65-30-22-14	1SBL387001R1422	1.000				

(1) For other auxiliary contacts arrangements, please contact your ABB local sales organization.

(2) AF.-30-...-11 not suitable for direct control by PLC-output.

Main dimensions mm, inches

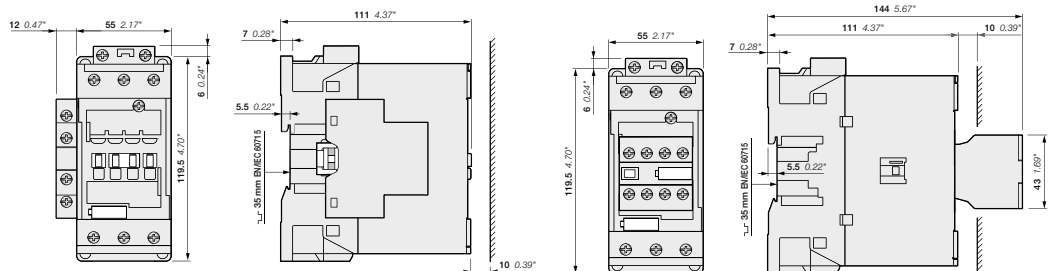

AF40, AF52, AF65-30-11-...

AF40, AF52, AF65-30-22-...

1SBC101741S0201 - Rev. A

AF80 ... AF96 2-stack 3-pole contactors

37 to 45 kW

AC / DC operated



AF80-30-11

1SBC101017V0014

Description

AF80 ... AF96 contactors are mainly used for controlling 3-phase motors and power circuits up to 690 V AC and 220 V DC. These contactors are of the block type design with 3 main poles (1st stack):

- 2nd stack with permanently fixed auxiliary contact block. The built-in auxiliary contact elements are mechanically linked (side-marked symbol) and the N.C. auxiliary contacts are mirror contacts
- control circuit: AC or DC operated with electronic coil interface accepting a wide control voltage range (e.g. 100...250 V AC and DC), only 4 control voltage ranges covering 24...500 V 50/60 Hz and 20...500 V DC
 - can manage large control voltage variations
 - reduced panel energy consumption
 - very distinct closing and opening.
- built-in surge suppression
- add-on auxiliary contact blocks for side mounting and a wide range of accessories.



AF80-30-22

1SBC101007V0014

Ordering details

IEC		UL / CSA		Rated control circuit voltage		Auxiliary contacts fitted	Type (1)	Order code	Weight
Rated operational power	operational current	3-phase motor rating	General use rating	Uc min. ... Uc max.	Uc max.				
400 V AC-3	AC-1	480 V	600 V AC	V 50/60 Hz	V DC				kg
37	125	60	105	24...60	-		AF80-30-11-41	1SBL397001R4111	1.260
							AF80-30-22-41	1SBL397001R4122	1.270
				24...60	20...60 (2)	AF80-30-11-11	1SBL397001R1111	1.260	
						AF80-30-22-11	1SBL397001R1122	1.270	
				48...130	48...130	AF80-30-11-12	1SBL397001R1211	1.260	
						AF80-30-22-12	1SBL397001R1222	1.270	
				100...250	100...250	AF80-30-11-13	1SBL397001R1311	1.210	
						AF80-30-22-13	1SBL397001R1322	1.220	
				250...500	250...500	AF80-30-11-14	1SBL397001R1411	1.210	
						AF80-30-22-14	1SBL397001R1422	1.220	
45	130	60	115	24...60	-		AF96-30-11-41	1SBL407001R4111	1.260
							AF96-30-22-41	1SBL407001R4122	1.270
				24...60	20...60 (2)	AF96-30-11-11	1SBL407001R1111	1.260	
						AF96-30-22-11	1SBL407001R1122	1.270	
				48...130	48...130	AF96-30-11-12	1SBL407001R1211	1.260	
						AF96-30-22-12	1SBL407001R1222	1.270	
				100...250	100...250	AF96-30-11-13	1SBL407001R1311	1.210	
						AF96-30-22-13	1SBL407001R1322	1.220	
				250...500	250...500	AF96-30-11-14	1SBL407001R1411	1.210	
						AF96-30-22-14	1SBL407001R1422	1.220	

(1) For other auxiliary contacts arrangements, please contact your ABB local sales organization.

(2) AF.-30-...-11 not suitable for direct control by PLC-output.

Main dimensions mm, inches

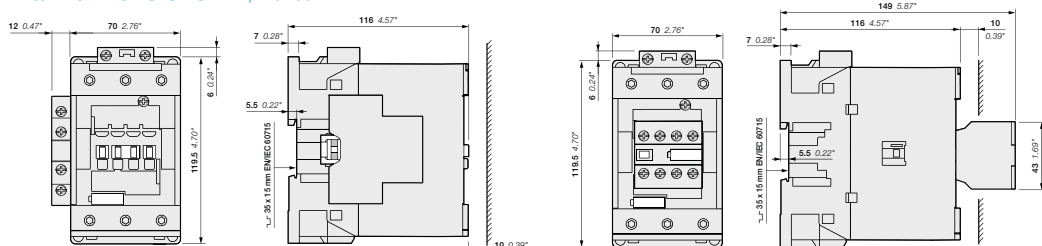

AF80, AF96-30-11...

AF80, AF96-30-22...

1SBC101742S0201 - Rev. A

AF09 ... AF96 2-stack 3-pole contactors

Main accessories

Contactor and main accessories (other accessories available)

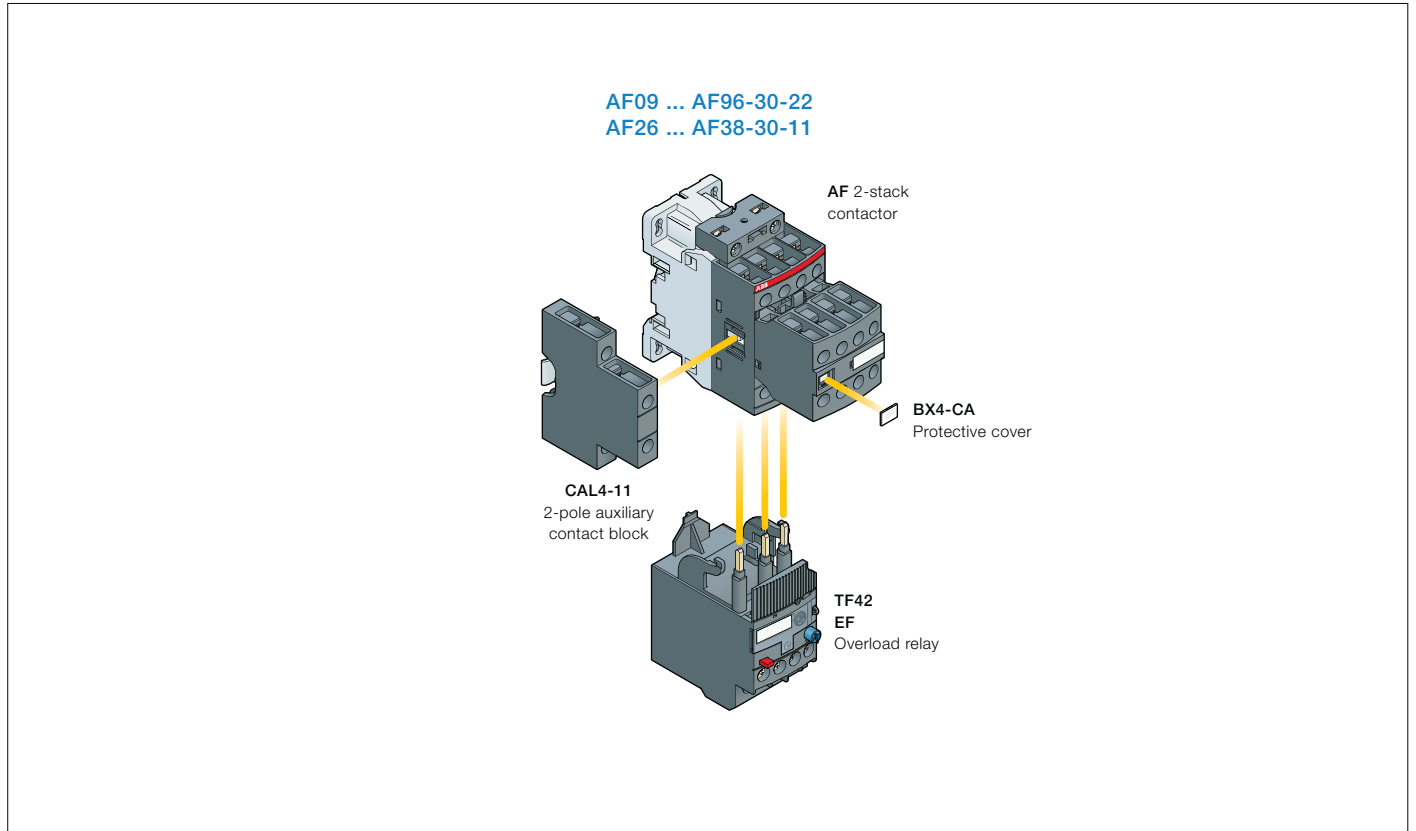

Main accessory fitting details

Many configurations of accessories are possible depending on whether these are front-mounted or side-mounted.

Contactor types	Main poles		Built-in auxiliary contacts		Front-mounted accessories					Side-mounted accessories					
	I	L	I	L	Auxiliary contact blocks			Electronic timer	Electrical and mechanical interlock set (between 2 contactors)		Auxiliary contact blocks				
					1-pole CA4	1-pole CC4	2-pole CAT4-11	4-pole CA4	TEF4	VEM4	Left side 2-pole CAL4-11	Right side			
AF26 ... AF38	3	0	1	1	-	-	-	-	-	-	+	1	+	1	
AF40 ... AF65	3	0	1	1	4 max.	or 1	or 1	or 1	or 1	-	-	-	-	+	1
AF80 ... AF96	3	0	1	1	4 max.	-	or 1	-	or 1	-	-	-	-	+	1
AF09 ... AF96	3	0	2	2	-	-	-	-	-	-	-	+	1	-	-
AF40 ... AF96	3	0	2	2	-	-	-	-	-	-	-	+	1	+	1

Overload relays fitting details (1)

Contactor types	Thermal overload relays	Electronic overload relays
AF09 ... AF38	TF42 (0.10...38 A)	EF19 (0.10...19 A)
AF26 ... AF38	TF42 (0.10...38 A)	EF45 (9...45 A)
AF40 ... AF65	TF65 (22...67 A)	EF65 (20...70 A)
AF80, AF96	TF96 (40...96 A)	EF96 (36...100 A)

The addition of an overload relay on the contactor does not prevent fitting of many other accessories as shown above.

(1) Direct mounting - No kit required.

AF09 ... AF96 2-stack 3-pole contactors

Main accessories



CAL4-11



VM4



BEA16-4



TEF4-ON

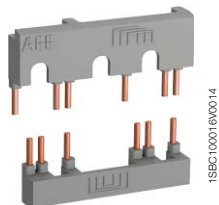

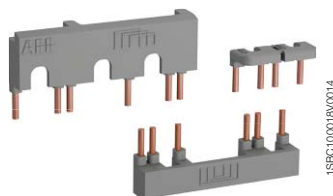

BER16-4



BEY16-4

Ordering Details (1)

For contactors	Auxiliary contacts	Type	Order code	Pkg qty	Weight (1 pce)
	 				kg

Side-mounted instantaneous auxiliary contact blocks

AF09 ... AF96	1 1	- -	CAL4-11	1SBN010120R1011	1	0.040
	1 1	- -	CAL4-11-T	1SBN010120T1011	10	0.040

Mechanical interlock unit

AF09 ... AF38			VM4	1SBN030105T1000	10	0.005
AF40 ... AF96			VM96-4	1SBN033405T1000	10	0.006

Note: VM4 and VM96-4 include 2 fixing clips (BB4) to maintain together both contactors.

For contactors	Time delay range selected by switch	Delay type	Auxiliary contacts	Type	Order code	Pkg qty	Weight (1 pce)
							kg

Electronic timers

AF40 ... AF96-30-11	0.1...1 s	ON-delay	1 1	TEF4-ON	1SBN020112R1000	1	0.065
	1...10 s	OFF-delay	1 1	TEF4-OFF	1SBN020114R1000	1	0.065
	10...100 s						

Note: Rated control circuit voltage U_c 24...240 V 50/60 Hz or DC.

Connecting links with manual motor starters

AF09 ... AF16	with	MS116-0.16 ... MS116-25, MS132-0.16 ... MS132-25		BEA16-4	1SBN081306T1000	10	0.025
AF26 ... AF38	with	MS116-0.16 ... MS116-16, MS132-0.16 ... MS132-10		BEA26-4	1SBN082306T1000	10	0.025
	with	MS116-20 ... MS116-32, MS132-12 ... MS132-32		BEA38-4	1SBN082306T2000	10	0.030
AF40 ... AF65	with	MS165-16 ... MS165-65		BEA65-4	1SBN083406R1000	1	0.090

Connection sets for reversing contactors

AF09 ... AF16				BER16-4	1SBN081311R1000	1	0.045
AF26 ... AF38				BER38-4	1SBN082311R1000	1	0.100
AF40 ... AF65				BER65-4	1SBN083411R1000	1	0.175
AF80 ... AF96				BER96-4	1SBN083911R1000	1	0.250

Connection sets for star-delta starting

AF09 ... AF16	with or without VM4			BEY16-4	1SBN081313R2000	1	0.050
AF26 ... AF38	with or without VM4			BEY38-4	1SBN082713R2000	1	0.110
AF40 ... AF65	with or without VM96-4			BEY65-4	1SBN083413R2000	1	0.200
AF80 ... AF96	with or without VM96-4			BEY96-4	1SBN083913R2000	1	0.250

(1) For more information, refer to "Accessories" section.

AF116 ... AF146 3-pole contactors

55 to 75 kW

AC / DC operated with 2 N.O. + 2 N.C. auxiliary contacts



AF146-30-22

1SFC101009W0001

Description

AF116 ... AF146 contactors are mainly used for controlling 3-phase motors and power circuits up to 690 V AC, AF146 up to 1000 V AC and AF116 ... AF146 up to 260 V DC. These contactors are of the block type design with 3 main poles.

- control circuit: AC or DC operated with electronic coil interface accepting a wide control voltage range (e.g. 100...250 V AC and DC), only 4 coils to cover control voltages between 24...500 V 50/60 Hz and 20...500 V DC
- can manage large control voltage variations
- reduced panel energy consumption
- very distinct closing and opening
- can withstand short voltage dips and voltage sags (SEMI F47 conditions of use on request).
- built-in surge suppression
- add-on auxiliary contact blocks for side mounting and a wide range of accessories.

Ordering details

IEC		UL / CSA		Rated control circuit voltage		Auxiliary contacts fitted	Type (1)	Order code	Weight
Rated operational power	current $\theta \leq 40^\circ\text{C}$	3-phase motor rating	General use rating	Uc min. ... Uc max.	Uc max.				
400 V	AC-3	AC-1	480 V	600 V AC	V 50/60 Hz; V DC				kg
kW	A	hp	A						

For connection with built-in cable clamps

Rated power (kW)	Rated current (A)	Motor rating (hp)	General use rating (A)	Uc min. (V)	Uc max. (V)	NO	NC	Type	Order code	Weight (kg)
55	160	75	160	24...60	20...60	2	2	AF116-30-22-11	1SFL427001R1122	1.750
				48...130	48...130	2	2	AF116-30-22-12	1SFL427001R1222	1.750
				100...250	100...250	2	2	AF116-30-22-13	1SFL427001R1322	1.750
				250...500	250...500	2	2	AF116-30-22-14	1SFL427001R1422	1.750
75	200	100	200	24...60	20...60	2	2	AF140-30-22-11	1SFL447001R1122	1.750
				48...130	48...130	2	2	AF140-30-22-12	1SFL447001R1222	1.750
				100...250	100...250	2	2	AF140-30-22-13	1SFL447001R1322	1.750
				250...500	250...500	2	2	AF140-30-22-13	1SFL447001R1422	1.750
75	225	100	200	24...60	20...60	2	2	AF146-30-22-11	1SFL467001R1122	1.750
				48...130	48...130	2	2	AF146-30-22-12	1SFL467001R1222	1.750
				100...250	100...250	2	2	AF146-30-22-13	1SFL467001R1322	1.750
				250...500	250...500	2	2	AF146-30-22-14	1SFL467001R1422	1.750

With bar connections

Rated power (kW)	Rated current (A)	Motor rating (hp)	General use rating (A)	Uc min. (V)	Uc max. (V)	NO	NC	Type	Order code	Weight (kg)
55	160	75	160	24...60	20...60	2	2	AF116-30-22B-11	1SFL427002R1122	1.500
				48...130	48...130	2	2	AF116-30-22B-12	1SFL427002R1222	1.500
				100...250	100...250	2	2	AF116-30-22B-13	1SFL427002R1322	1.500
				250...500	250...500	2	2	AF116-30-22B-14	1SFL427002R1422	1.500
75	200	100	200	24...60	20...60	2	2	AF140-30-22B-11	1SFL447002R1122	1.500
				48...130	48...130	2	2	AF140-30-22B-12	1SFL447002R1222	1.500
				100...250	100...250	2	2	AF140-30-22B-13	1SFL447002R1322	1.500
				250...500	250...500	2	2	AF140-30-22B-14	1SFL447002R1422	1.500
75	225	100	200	24...60	20...60	2	2	AF146-30-22B-11	1SFL467002R1122	1.500
				48...130	48...130	2	2	AF146-30-22B-12	1SFL467002R1222	1.500
				100...250	100...250	2	2	AF146-30-22B-13	1SFL467002R1322	1.500
				250...500	250...500	2	2	AF146-30-22B-14	1SFL467002R1422	1.500

(1) For other auxiliary contacts arrangements, please contact your ABB local sales organization.

Main dimensions mm, inches

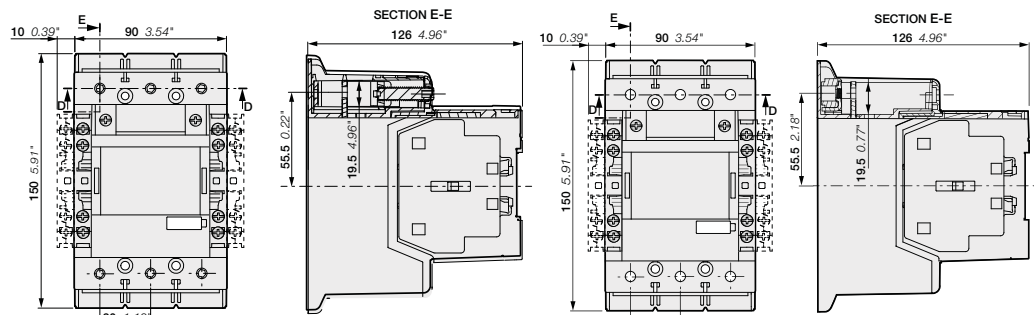

AF116, AF140, AF146-30-22

AF116, AF140, AF146-30-22B

1SFC101092C0201 - Rev. D

AF116 ... AF146 3-pole contactors with built-in PLC interface

55 to 75 kW

AC / DC operated with 2 N.O. + 2 N.C. auxiliary contacts



AF146-30-22



AF146-30-22B

Description

AF116 ... AF146 contactors are mainly used for controlling 3-phase motors and power circuits up to 690 V AC, AF146 up to 1000 V AC and AF116 ... AF146 up to 260 V DC. These contactors are of the block type design with 3 main poles.

- control circuit: AC or DC operated with electronic coil interface accepting a wide control voltage range (e.g. 100...250 V AC and DC), only 2 coils to cover control voltages between 100...500 V 50/60 Hz and 100...500 V DC
- can manage large control voltage variations
- reduced panel energy consumption
- very distinct closing and opening
- can withstand short voltage dips and voltage sags (SEMI F47 conditions of use on request).
- built-in surge suppression
- add-on auxiliary contact blocks for side mounting and a wide range of accessories.

Ordering details

IEC		UL / CSA		Rated control circuit voltage		Auxiliary contacts fitted	Type (1)	Order code	Weight Pkg (1 pce)
Rated operational power	current $\theta \leq 40^\circ\text{C}$	3-phase motor rating	General use rating	Uc min. ...	Uc max.				
400 V AC-3	AC-1	480 V	600 V AC	V 50/60 Hz	V DC				kg
kW	A	hp	A						

For connection with built-in cable clamps

55	160	75	160	100...250	100...250	2 2	AF116-30-22-33	1SFL427001R3322	1.750
				250...500	250...500	2 2	AF116-30-22-34	1SFL427001R3422	1.750
75	200	100	200	100...250	100...250	2 2	AF140-30-22-33	1SFL447001R3322	1.750
				250...500	250...500	2 2	AF140-30-22-34	1SFL447001R3422	1.750
75	225	100	200	100...250	100...250	2 2	AF146-30-22-33	1SFL467001R3322	1.750
				250...500	250...500	2 2	AF146-30-22-34	1SFL467001R3422	1.750

With bar connections

55	160	75	160	100...250	100...250	2 2	AF116-30-22B-33	1SFL427002R3322	1.500
				250...500	250...500	2 2	AF116-30-22B-34	1SFL427002R3422	1.500
75	200	100	200	100...250	100...250	2 2	AF140-30-22B-33	1SFL447002R3322	1.500
				250...500	250...500	2 2	AF140-30-22B-34	1SFL447002R3422	1.500
75	225	100	200	100...250	100...250	2 2	AF146-30-22B-33	1SFL467002R3322	1.500
				250...500	250...500	2 2	AF146-30-22B-34	1SFL467002R3422	1.500

(1) For other auxiliary contacts arrangements, please contact your ABB local sales organization.

AF116 ... AF146 are equipped with low voltage inputs for control, for example by a PLC.

Control inputs

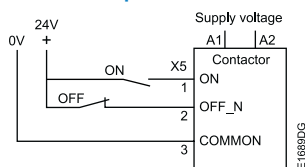

Main dimensions mm, inches

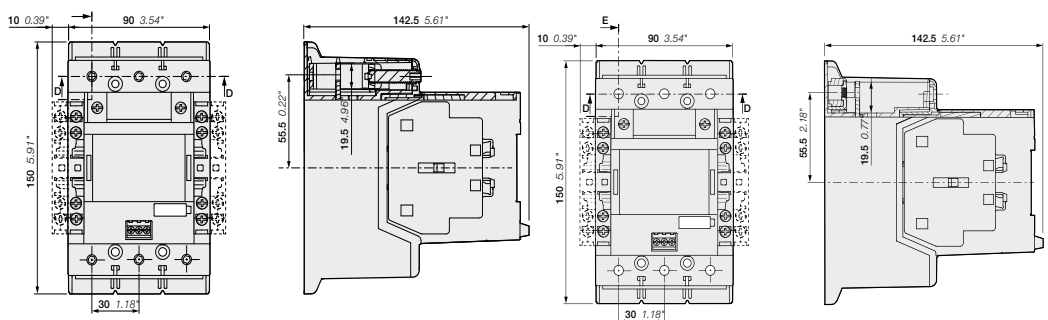

AF116, AF140, AF146-30-22

AF116, AF140, AF146-30-22B

AF190 ... AF370 3-pole contactors

90 to 200 kW

AC / DC operated with 2 N.O. + 2 N.C. auxiliary contacts



AF205-30-22

1SFC1011410001



AF370-30-22

1SFC101020V0001

Description

AF190 ... AF370 contactors are mainly used for controlling 3-phase motors and power circuits up to 1000 V AC and up to 340 V DC. These contactors are of the block type design with 3 main poles.

- control circuit: AC or DC operated with electronic coil interface accepting a wide control voltage range (e.g. 100...250 V AC and DC), only 4 coils to cover control voltages between 24...500 V 50/60 Hz and 20...500 V DC
 - can manage large control voltage variations
 - reduced panel energy consumption
 - very distinct closing and opening
 - can withstand short voltage dips and voltage sags (SEMI F47 conditions of use on request).
- built-in surge suppression
- add-on auxiliary contact blocks for side mounting and a wide range of accessories.

Ordering details

IEC		UL / CSA		Rated control circuit voltage		Auxiliary contacts fitted		Type (1)	Order code	Weight
Rated operational power	current $\theta \leq 40^\circ\text{C}$	3-phase motor rating	General use rating	Uc min. ... Uc max.						Pkg (1 pce)
400 V AC-3	AC-1	480 V	600 V AC							kg
kW	A	hp	A	V 50/60 Hz	V DC					
90	275	125	250	24...60	20...60	2	2	AF190-30-22-11	1SFL487002R1122	3,000
				48...130	48...130	2	2	AF190-30-22-12	1SFL487002R1222	3,000
				100...250	100...250	2	2	AF190-30-22-13	1SFL487002R1322	3,000
				250...500	250...500	2	2	AF190-30-22-14	1SFL487002R1422	3,000
110	350	150	300	24...60	20...60	2	2	AF205-30-22-11	1SFL527002R1122	3,000
				48...130	48...130	2	2	AF205-30-22-12	1SFL527002R1222	3,000
				100...250	100...250	2	2	AF205-30-22-13	1SFL527002R1322	3,000
				250...500	250...500	2	2	AF205-30-22-14	1SFL527002R1422	3,000
132	400	200	350	24...60	20...60	2	2	AF265-30-22-11	1SFL547002R1122	4,675
				48...130	48...130	2	2	AF265-30-22-12	1SFL547002R1222	4,675
				100...250	100...250	2	2	AF265-30-22-13	1SFL547002R1322	4,675
				250...500	250...500	2	2	AF265-30-22-14	1SFL547002R1422	4,675
160	500	250	400	24...60	20...60	2	2	AF305-30-22-11	1SFL587002R1122	4,675
				48...130	48...130	2	2	AF305-30-22-12	1SFL587002R1222	4,675
				100...250	100...250	2	2	AF305-30-22-13	1SFL587002R1322	4,675
				250...500	250...500	2	2	AF305-30-22-14	1SFL587002R1422	4,675
200	600	300	520	24...60	20...60	2	2	AF370-30-22-11	1SFL607002R1122	4,675
				48...130	48...130	2	2	AF370-30-22-12	1SFL607002R1222	4,675
				100...250	100...250	2	2	AF370-30-22-13	1SFL607002R1322	4,675
				250...500	250...500	2	2	AF370-30-22-14	1SFL607002R1422	4,675

(1) For other auxiliary contacts arrangements, please contact your ABB local sales organization.

Main dimensions mm, inches

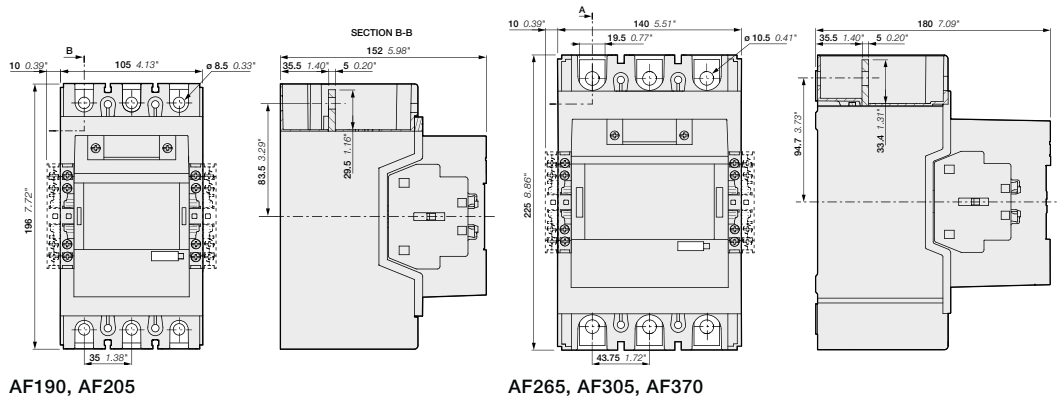

1SFC101093C0201 - Rev. E

AF190 ... AF370 3-pole contactors with built-in PLC interface

90 to 200 kW

AC / DC operated with 2 N.O. + 2 N.C. auxiliary contacts



AF205-30-22

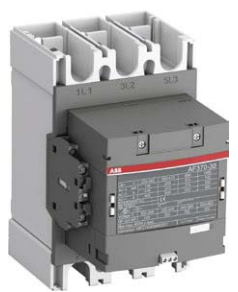

AF370-30-22

Description

AF190 ... AF370 contactors are mainly used for controlling 3-phase motors and power circuits up to 1000 V AC and up to 340 V DC. These contactors are of the block type design with 3 main poles.

- control circuit: AC or DC operated with electronic coil interface accepting a wide control voltage range (e.g. 100...250 V AC and DC), only 2 coils to cover control voltages between 100...500 V 50/60 Hz and 100...500 V DC
- can manage large control voltage variations
- reduced panel energy consumption
- very distinct closing and opening
- can withstand short voltage dips and voltage sags (SEMI F47 conditions of use on request).
- built-in surge suppression
- add-on auxiliary contact blocks for side mounting and a wide range of accessories.

Ordering details

IEC		UL / CSA		Rated control circuit voltage		Auxiliary contacts fitted		Type (1)	Order code	Weight
Rated operational power	current $\theta \leq 40^\circ\text{C}$	3-phase motor rating	General use rating	Uc min. ...	Uc max.	I L				Pkg (1 pce)
400 V AC-3	AC-1	hp	A	V 50/60 Hz	V DC					kg
90	275	125	250	100...250	100...250	2	2	AF190-30-22-33	1SFL487002R3322	3.000
				250...500	250...500	2	2	AF190-30-22-34	1SFL487002R3422	3.000
110	350	150	300	100...250	100...250	2	2	AF205-30-22-33	1SFL527002R3322	3.000
				250...500	250...500	2	2	AF205-30-22-34	1SFL527002R3422	3.000
132	400	200	350	100...250	100...250	2	2	AF265-30-22-33	1SFL547002R3322	4.675
				250...500	250...500	2	2	AF265-30-22-34	1SFL547002R3422	4.675
160	500	250	400	100...250	100...250	2	2	AF305-30-22-33	1SFL587002R3322	4.675
				250...500	250...500	2	2	AF305-30-22-34	1SFL587002R3422	4.675
200	600	300	520	100...250	100...250	2	2	AF370-30-22-33	1SFL607002R3322	4.675
				250...500	250...500	2	2	AF370-30-22-34	1SFL607002R3422	4.675

(1) For other auxiliary contacts arrangements, please contact your ABB local sales organization.

AF190 ... AF370 are equipped with low voltage inputs for control, for example by a PLC.

Control inputs

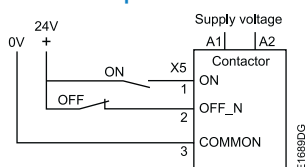

Main dimensions mm, inches

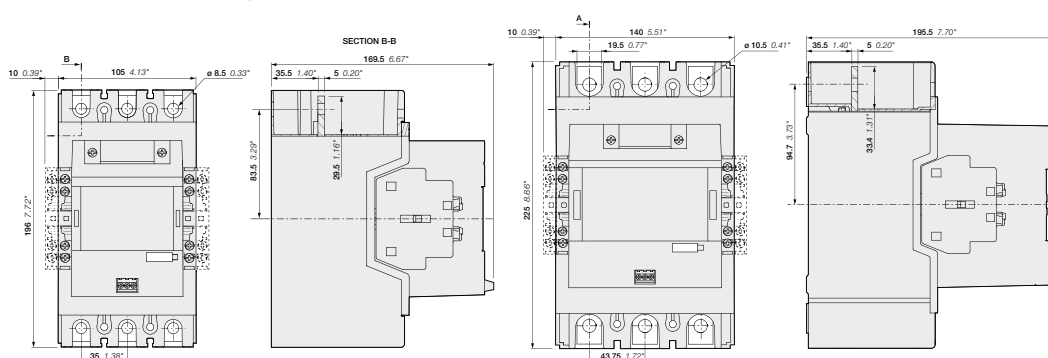

AF190, AF205

AF265, AF305, AF370

1SFC101168C0201 - Rev. A

AF116 ... AF370 3-pole contactors with 2 N.O. + 2 N.C. auxiliary contacts Main accessories

Main accessories (other accessories available)

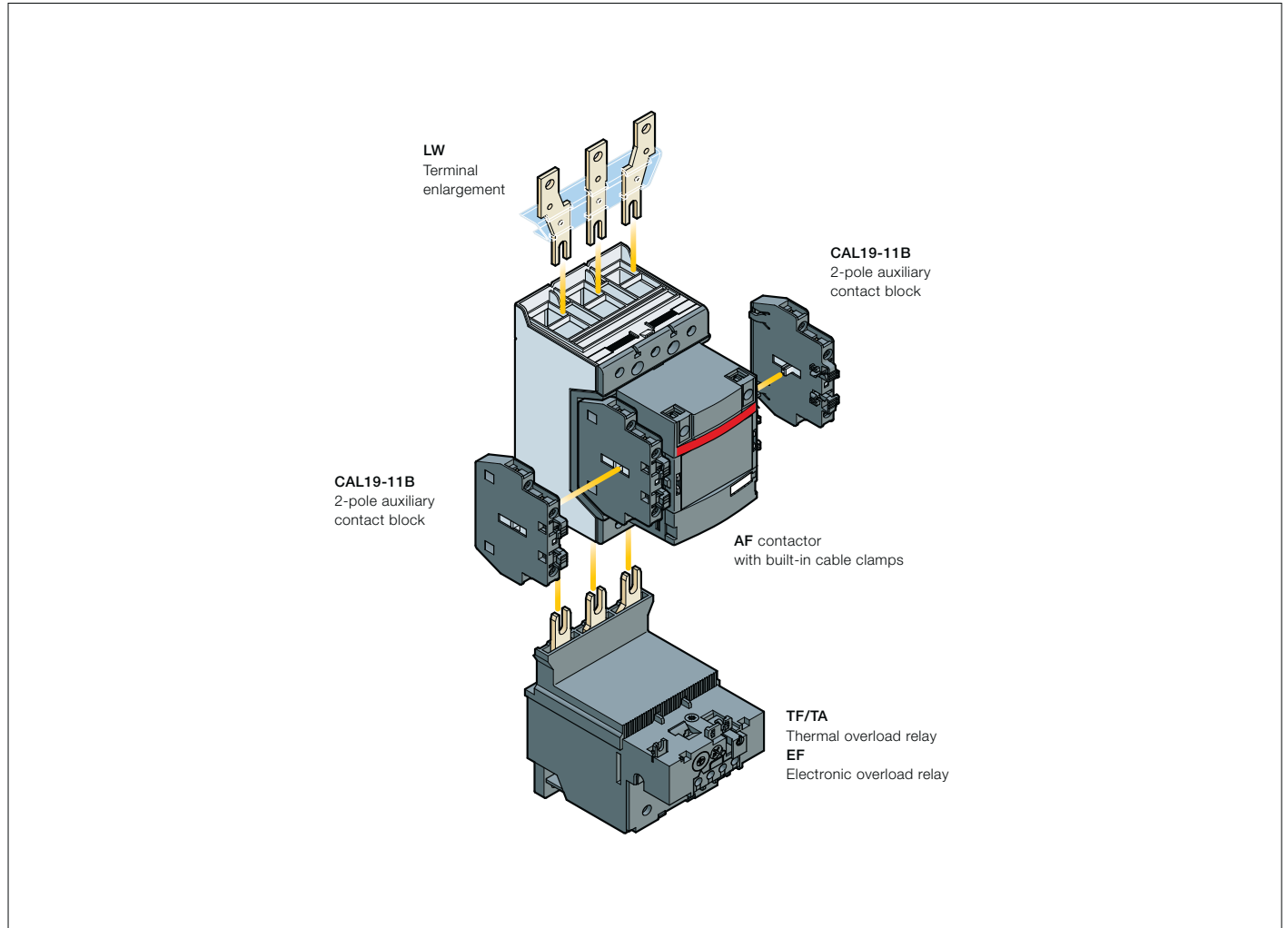

Main accessory fitting details

Contactor types	Main poles	Available auxiliary contacts	Side-mounted accessories		
			Auxiliary contact blocks		Mechanical interlock units (between two contactors)
			CAL19-11 (2)	CAL19-11B (2)	
AF116 ... AF370	3	0 2 2	2 x CAL19-11 included	+ 2 x CAL19-11B	-

(2) The CEL19 auxiliary contact blocks can replace the CAL19-11 and CAL19-11B. Though, no auxiliary contact block can be mounted outside the CEL19.

Overload relays fitting details (1)

Contactor types	Thermal overload relays	Electronic overload relays
AF116 ... AF140	TF140DU (66...142 A)	EF146 (54...150 A)
AF146	-	EF146 (54...150 A)
AF190, AF205	TA200DU (66...200 A)	EF205 (63...210 A)
AF265 ... AF370	-	EF370 (115...380 A)

The addition of a thermal or electronic overload relay on the contactor does not prevent fitting of many other accessories as shown in "Main accessory fitting details" table.

(1) Direct mounting - No kit required.

AF116 ... AF370 3-pole contactors with 2 N.O. + 2 N.C. auxiliary contacts Main accessories



1SFC101071V0001

CAL19-11



1SFC101041V0001

LT370-30C



1SFC101048V0001

LX140

Ordering details (1)

For contactors	Auxiliary contacts	Type	Order code	Pkg qty	Weight (1 pce)
					kg

Side-mounted instantaneous auxiliary contact blocks

AF116 ... AF370	1	1	CAL19-11B	1SFN010820R3311	2	0.050
-----------------	---	---	-----------	-----------------	---	-------

Terminal shrouds

AF116 ... AF146, with compression lugs	LT140-30L	1SFN124203R1000	2	0.070
AF190, AF205, with cable clamps	LT205-30C	1SFN124801R1000	2	0.050
AF190, AF205, with compression lugs	LT205-30L	1SFN124803R1000	2	0.220
AF190, AF205, with shorting bar or between contactor and TOL/EOL in DOL-starters	LT205-30Y	1SFN124804R1000	1	0.050
AF265 ... AF370, with cable clamps	LT370-30C	1SFN125401R1000	2	0.035
AF265 ... AF370, with compression lugs	LT370-30L	1SFN125403R1000	2	0.280
AF265 ... AF370, with shorting bar or between contactor and TOL/EOL in DOL-starters	LT370-30Y	1SFN125404R1000	1	0.075
AF265 ... AF370, for use with extending cable clamps, ATK300/2 and OZXB4	LT370-30D	1SFN125406R1000	1	0.150

For contactors	Dimensions		Type	Order code	Pkg qty	Weight (1 pce)
	hole Ø mm	bar mm				

Terminal enlargements

AF116...AF146	6.5	13 x 3	LW140	1SFN074207R1000	1	0.115
AF190...AF205	10.5	17.5 x 5	LW205	1SFN074807R1000	1	0.260
AF265...AF370	10.5	20 x 5	LW370	1SFN075407R1000	1	0.340

Terminal extension

AF116...AF146	6.5	13 x 3	LX140	1SFN074210R1000	1	0.072
AF190...AF250	8.5	17.5 x 5	LX205	1SFN074810R1000	1	0.180
AF265...AF370	10.5	20 x 5	LX370	1SFN075410R1000	1	0.234

(1) For more information, refer to "Accessories" section.

AF400 ... AF750 3-pole contactors

200 to 400 kW

AC / DC operated with 2 N.O. + 2 N.C. auxiliary contacts



AF460-30-22

1SFC101081W0001



AF750-30-22

1SFC101081W0001

Description

AF400 ... AF750 contactors are mainly used for controlling 3-phase motors and power circuits up to 690 V AC or 600 V DC (2). These contactors are of the block type design with 3 main poles.

- control circuit: AC or DC operated with electronic coil interface accepting a wide control voltage range (e.g. 100...250 V AC and DC), only 4 coils to cover control voltages between 48...500 V 50/60 Hz and 24...500 V DC
- can manage large control voltage variations
- reduced panel energy consumption
- very distinct closing and opening
- can withstand short voltage dips and voltages sags (SEMI F47 conditions of use on request).
- built-in surge suppression
- add-on auxiliary contact blocks for side mounting and a wide range of accessories.

Ordering details

IEC Rated operational power 400 V AC-3 kW	UL/CSA 3-phase motor rating hp	General use rating A	Rated control circuit voltage Uc		Auxiliary contacts fitted		Type	Order code	Weight Pkg (1 pce) kg	
			Rated operational current $\theta \leq 40^\circ\text{C}$ 690 V AC-1 A	3-phase motor rating 480 V hp	V 50/60 Hz	V DC				NO
200	350	550	600	-	24...60	2	2	AF400-30-22	1SFL577001R6822 (1)	12.000
				48...130	48...130	2	2	AF400-30-22	1SFL577001R6922	12.000
				100...250	100...250	2	2	AF400-30-22	1SFL577001R7022	12.000
				250...500	250...500	2	2	AF400-30-22	1SFL577001R7122	12.000
250	400	650	700	-	24...60	2	2	AF460-30-22	1SFL597001R6822 (1)	12.000
				48...130	48...130	2	2	AF460-30-22	1SFL597001R6922	12.000
				100...250	100...250	2	2	AF460-30-22	1SFL597001R7022	12.000
				250...500	250...500	2	2	AF460-30-22	1SFL597001R7122	12.000
315	500	750	800	-	24...60	2	2	AF580-30-22	1SFL617001R6822 (1)	15.000
				48...130	48...130	2	2	AF580-30-22	1SFL617001R6922	15.000
				100...250	100...250	2	2	AF580-30-22	1SFL617001R7022	15.000
				250...500	250...500	2	2	AF580-30-22	1SFL617001R7122	15.000
400	600	900	1050	-	24...60	2	2	AF750-30-22	1SFL637001R6822 (1)	15.000
				48...130	48...130	2	2	AF750-30-22	1SFL637001R6922	15.000
				100...250	100...250	2	2	AF750-30-22	1SFL637001R7022	15.000
				250...500	250...500	2	2	AF750-30-22	1SFL637001R7122	15.000

(1) The connection polarities indicated close to the coil terminals must be respected: A1 for the positive pole and A2 for the negative pole.

(2) Up to 850 V DC for AF580, AF750.

AF400...AF750 are equipped with low voltage inputs for control, for example by a PLC.

Control inputs

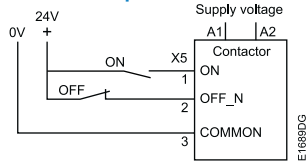

Main dimensions mm, inches

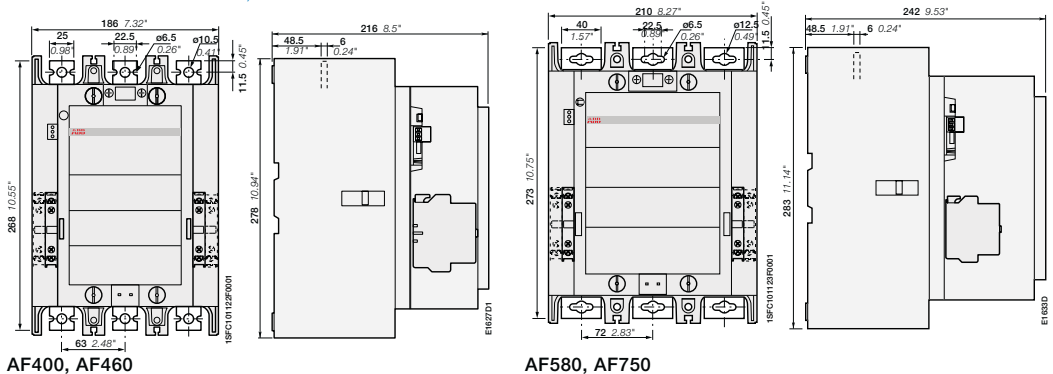

AF400, AF460

AF580, AF750

1SFC101014C0201 - Rev. A

AF1250 ... AF2650 3-pole contactors

475 to 560 kW and 1260 to 2650 A AC-1

AC / DC operated with 2 N.O. + 2 N.C. auxiliary contacts



AF1250-30-22



AF2650-30-22

Description

AF1250 ... AF2050 contactors are mainly used for controlling power circuits up to 1000 V AC or 850 V DC, AF2650 for controlling power up to 1000 V AC. These contactors are of the block type design with 3 main poles.

- control circuit: AC or DC operated with electronic coil interface accepting a wide control voltage range (e.g. 100...250 V AC and DC)
- only 4 coils for AF1250 to cover control voltages between 48...500 V 50/60 Hz and 24...500 V DC
- only 1 coil for AF1350 ... AF2650 to cover control voltages between 100...250 V 50/60 Hz and 100...250 V DC
- can manage large control voltage variations
- reduced panel energy consumption
- very distinct closing and opening
- can withstand short voltage dips and voltages sags (SEMI F47 conditions of use on request).
- built-in surge suppression
- add-on auxiliary contact blocks for side mounting and a wide range of accessories.

Ordering details

IEC		UL/CSA		Rated control circuit voltage		Auxiliary contacts fitted		Type	Order code	Weight
Rated operational power	current $\theta \leq 40^\circ\text{C}$	3-phase motor rating	General use rating	Uc (1)		Type				Pkg (1 pce)
kW	A	hp	A	V 50/60 Hz	V DC	Type				kg
-	1260	-	1210	-	24...60	2	2	AF1250-30-22	1SFL647001R6822 (1)	16.000
				48...130	48...130	2	2	AF1250-30-22	1SFL647001R6922	16.000
				100...250	100...250	2	2	AF1250-30-22	1SFL647001R7022	16.000
				250...500	250...500	2	2	AF1250-30-22	1SFL647001R7122	16.000
475	1350	800	1350	100...250	100...250	2	2	AF1350-30-22	1SFL657001R7022	34.000
560	1650	900	1650	100...250	100...250	2	2	AF1650-30-22	1SFL677001R7022	35.000
-	2050	-	2100	100...250	100...250	2	2	AF2050-30-22	1SFL707001R7022	35.000
-	2650	-	2700	100...250	100...250	2	2	AF2650-30-22	1SFL667001R7022	45.000

- (1) The connection polarities indicated close to the coil terminals must be respected: A1 for the positive pole and A2 for the negative pole.
 (2) AF2650 : Maximum operational voltage = 1000 V according to UL / CSA.

AF1250 ... AF2650 are equipped with low voltage inputs for control, for example by a PLC.

Control inputs

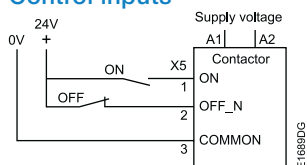

	AF1350, AF1650, AF2050	AF2650
A	392 mm / 15.43"	422 mm / 16.61"
B	47 mm / 1.85"	53 mm / 2.11"
C	10 mm / 0.39"	25 mm / 0.98"

Main dimensions mm, inches

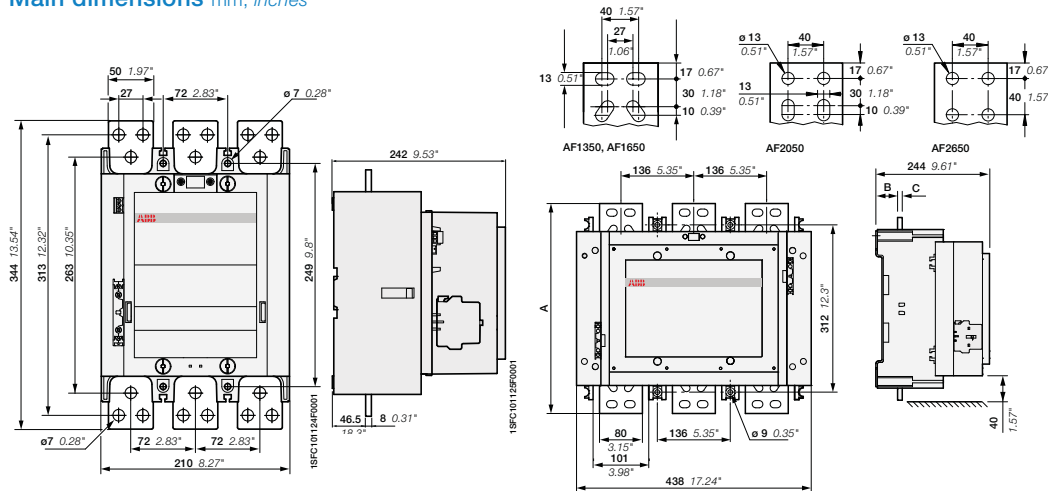

AF1250

AF1350, AF1650, AF2050, AF2650

AF400... AF2650 3-pole contactors with 2 N.O. + 2 N.C. auxiliary contacts Main accessories

Main accessories (other accessories available)

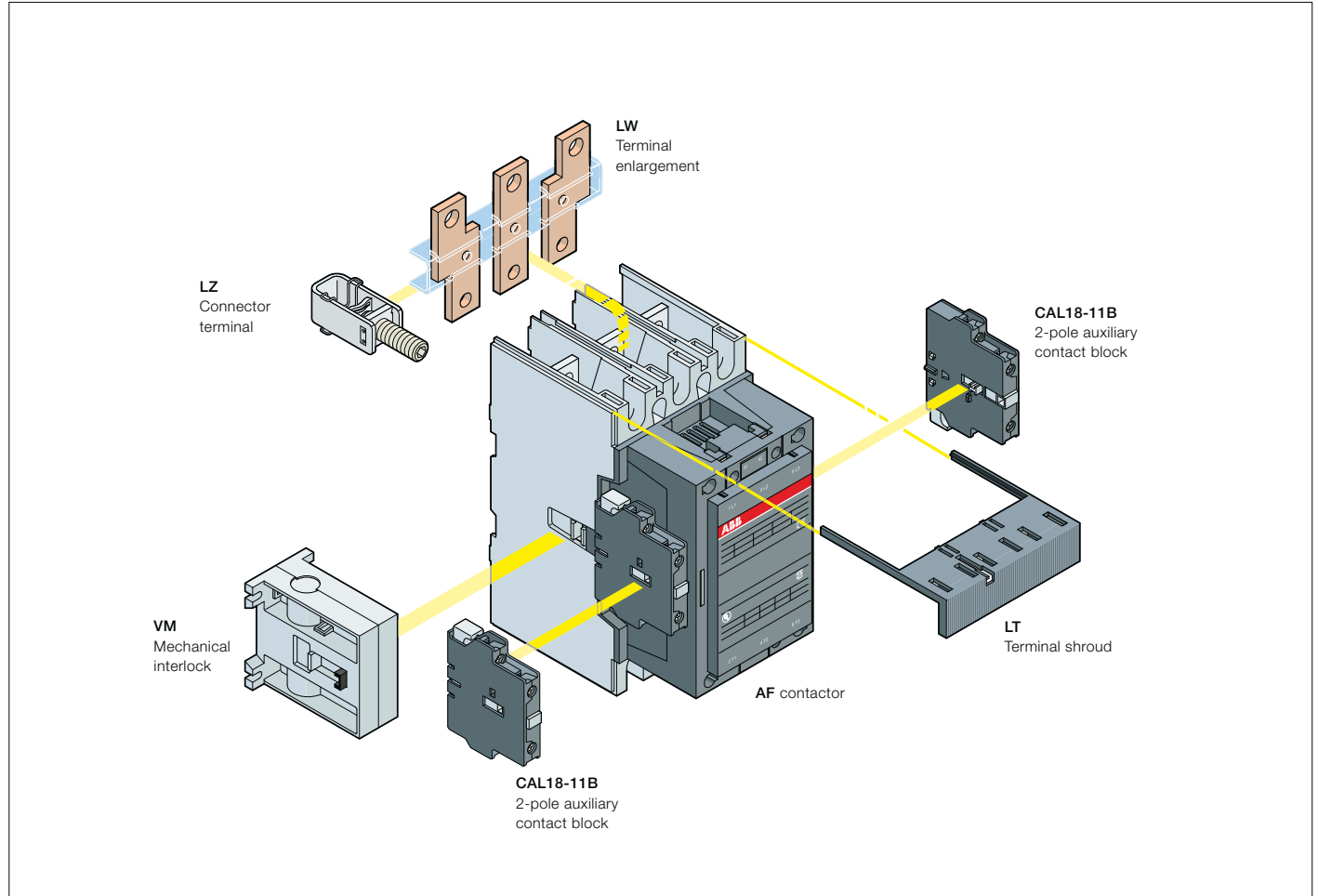

Main accessory fitting details

Contactor types	Main poles	Available auxiliary contacts	Side-mounted accessories		
			Auxiliary contact blocks		Mechanical interlock units (between two contactors)
			CAL18-11	CAL18-11B (2)	
Contactors + auxiliary contact blocks					
AF145 ... AF2650	3	0 2 2	2 x CAL18-11 included	2 x CAL18-11B	–
Contactors with mechanical interlocking + auxiliary contact blocks					
AF400 ... AF2650	3	0 2 2	2 x CAL18-11 included	4 x CAL18-11B	+ VM...H (1)

(1) Interlock type, according to the contactor ratings (see "Accessories").

(2) The CEL18-... auxiliary contact blocks can replace the CAL18-11 and CAL18-11B. Though, no auxiliary contact block can be mounted outside the CEL18-...

Overload relays fitting details

Contactor types	Thermal overload relays	Electronic overload relays
AF400, AF460	–	EF460 (150...500 A) (3)
AF580, AF750	–	EF750 (250...800 A) (3)
AF1350, AF1650	–	E1250DU (375...1250 A) (3)

The addition of a thermal or electronic overload relay on the contactor does not prevent fitting of many other accessories as shown in "Main accessory fitting details" table.

(3) Mounting kit required (see "Motor protection").

AF400 ... AF2650 3-pole contactors with 2 N.O. + 2 N.C. auxiliary contacts Main accessories



CAL18-11

1SFC101082V0001

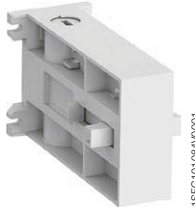

VM750H

1SFC101084V0001



LT460-AC

1SFC101089V0001

Ordering details (1)

For contactors	Auxiliary contacts	Type	Order code	Pkg qty	Weight (1 pce)
					kg

Side-mounted instantaneous auxiliary contact blocks

AF400 ... AF2650	1	1	CAL18-11B	1SFN010720R3311	2	0.050
------------------	---	---	-----------	-----------------	---	-------

Mechanical interlock unit

AF400 ... AF1250			VM750H	1SFN035700R1000	1	0.200
AF1350 ... AF2650			VM1650H	1SFN036503R1000	1	6.000

Terminal shrouds

AF400, AF460 with connectors			LT460-AC	1SFN125701R1000	2	0.100
AF400, AF460 with lugs			LT460-AL	1SFN125703R1000	2	0.800
AF580 ... AF750 with connectors			LT750-AC	1SFN126101R1000	2	0.120
AF580 ... AF750 with lugs			LT750-AL	1SFN126103R1000	2	0.825

For contactors	Dimensions		Type	Order code	Pkg qty	Weight (1 pce)
	hole Ø mm	bar mm				

Terminal enlargements

AF400, AF460	10.5	25 x 5	LW460	1SFN075707R1000	1	0.730
AF580, AF750	13	40 x 6	LW750	1SFN076107R1000	1	1.230
AF1250	13	50 x 10	LW1250	1SFN076407R1000	1	2.000

Terminal extension

AF400, AF460	10.5	25 x 5	LX460	1SFN075710R1000	1	0.500
AF580, AF750	13	40 x 6	LX750	1SFN076110R1000	1	0.850

(1) For more information, refer to "Accessories" section.

AF09 ... AF38 3-pole contactors

Technical data

Main pole - Utilization characteristics according to IEC

Contactor types	AC / DC operated	AF09	AF12	AF16	AF26	AF30	AF38
Standards		IEC 60947-1 / 60947-4-1 and EN 60947-1 / 60947-4-1					
Rated operational voltage U_e max.		690 V					
Rated frequency (without derating)		50 / 60 Hz					
Conventional free-air thermal current I_{th}							
acc. to IEC 60947-4-1, open contactors, $\theta \leq 40^\circ\text{C}$		35 A	35 A	35 A	50 A	50 A	50 A
With conductor cross-sectional area		6 mm ²	6 mm ²	6 mm ²	10 mm ²	10 mm ²	10 mm ²
AC-1 Utilization category							
For air temperature close to contactor							
I_e / Rated operational current AC-1	$\theta \leq 40^\circ\text{C}$	25 A	28 A	30 A	45 A	50 A	50 A
U_e max. ≤ 690 V, 50/60 Hz	$\theta \leq 60^\circ\text{C}$	25 A	28 A	30 A	40 A	42 A	42 A
	$\theta \leq 70^\circ\text{C}$	22 A	24 A	26 A	32 A	37 A	37 A
With conductor cross-sectional area		4 mm ²	6 mm ²	6 mm ²	10 mm ²	10 mm ²	10 mm ²
AC-3 Utilization category							
For air temperature close to contactor $\theta \leq 60^\circ\text{C}$							
I_e / Max. rated operational current AC-3 (1)							
	220-230-240 V	9 A	12 A	18 A	26 A	33 A	40 A
	380-400 V	9 A	12 A	18 A	26 A	32 A	38 A
	415 V	9 A	12 A	18 A	26 A	32 A	38 A
	440 V	9 A	12 A	18 A	26 A	32 A	38 A
	500 V	9.5 A	12.5 A	15 A	23 A	28 A	33 A
	690 V	7 A	9 A	10.5 A	17 A	21 A	24 A
Rated operational power AC-3 (1)							
	220-230-240 V	2.2 kW	3 kW	4 kW	6.5 kW	9 kW	11 kW
	380-400 V	4 kW	5.5 kW	7.5 kW	11 kW	15 kW	18.5 kW
	415 V	4 kW	5.5 kW	9 kW	11 kW	15 kW	18.5 kW
	440 V	4 kW	5.5 kW	9 kW	15 kW	18.5 kW	22 kW
	500 V	5.5 kW	7.5 kW	9 kW	15 kW	18.5 kW	22 kW
	690 V	5.5 kW	7.5 kW	9 kW	15 kW	18.5 kW	22 kW
Rated making capacity AC-3		10 x I_e AC-3 acc. to IEC 60947-4-1					
Rated breaking capacity AC-3		8 x I_e AC-3 acc. to IEC 60947-4-1					
AC-8a Utilization category							
(without thermal overload relay - U_e 400 V 50/60 Hz - $\theta \leq 40^\circ\text{C}$)							
I_e / Rated operational current AC-8a		12 A	16 A	22 A	30 A	40 A	50 A
Rated operational power AC-8a		5.5 kW	7.5 kW	11 kW	15 kW	20 kW	25 kW
Short-circuit protection device for contactors							
without thermal overload relay - Motor protection excluded (2)							
$U_e \leq 500$ V AC - gG type fuse		25 A	32 A	32 A	50 A	63 A	63 A
Rated short-time withstand current I_{cw}							
at 40 °C ambient temperature, in free air from a cold state							
	1 s	300 A	300 A	300 A	700 A	700 A	700 A
	10 s	150 A	150 A	150 A	350 A	350 A	350 A
	30 s	80 A	80 A	80 A	225 A	225 A	225 A
	1 min	60 A	60 A	60 A	150 A	150 A	150 A
	15 min	35 A	35 A	35 A	50 A	50 A	50 A
Maximum breaking capacity							
$\cos \varphi = 0.45$							
	at 440 V	250 A	250 A	250 A	500 A	500 A	500 A
	at 690 V	106 A	106 A	106 A	200 A	200 A	200 A
Power dissipation per pole							
	I_e / AC-1	0.8 W	1 W	1.2 W	1.8 W	2.4 W	2.4 W
	I_e / AC-3	0.1 W	0.2 W	0.35 W	0.6 W	0.9 W	1.3 W
Max. electrical switching frequency							
	AC-1	600 cycles/h					
	AC-3	1200 cycles/h					
	AC-2, AC-4	300 cycles/h				150 cycles/h	

(1) For the corresponding kW/A or hp/A values of 1500 r.p.m, 50 Hz or 1800 r.p.m, 60 Hz, 3-phase motors, see "Motor rated operational powers and currents".

(2) For the protection of motor starters against short circuits, see "Coordination with short-circuit protection devices".



3-phase motors



1500 r.p.m. 50 Hz
1800 r.p.m. 60 Hz
3-phase motors

AF40 ... AF96 3-pole contactors

Technical data

Main pole - Utilization characteristics according to IEC

Contactors types	AC / DC operated	AF40	AF52	AF65	AF80	AF96
Standards		IEC 60947-1 / 60947-4-1 and EN 60947-1 / 60947-4-1				
Rated operational voltage U _e max.		690 V				1000 V
Rated frequency (without derating)		50 / 60 Hz				
Conventional free-air thermal current I _{th}						
acc. to IEC 60947-4-1, open contactors, $\theta \leq 40\text{ °C}$		105 A	105 A	105 A	130 A	130 A
With conductor cross-sectional area		35 mm ²	35 mm ²	35 mm ²	50 mm ²	50 mm ²
AC-1 Utilization category						
For air temperature close to contactor						
I_e / Rated operational current AC-1	$\theta \leq 40\text{ °C}$	70 A	100 A	105 A	125 A	130 A
U _e max. $\leq 690\text{ V}$, 50/60 Hz	$\theta \leq 60\text{ °C}$	60 A	80 A	90 A	100 A	105 A
	$\theta \leq 70\text{ °C}$	50 A	70 A	80 A	85 A	90 A
With conductor cross-sectional area		25 mm ²	35 mm ²	35 mm ²	50 mm ²	50 mm ²
AC-3 Utilization category						
For air temperature close to contactor $\theta \leq 60\text{ °C}$						
I_e / Max. rated operational current AC-3 (1)						
	220-230-240 V	40 A	53 A	65 A	80 A	96 A
	380-400 V	40 A	53 A	65 A	80 A	96 A
	415 V	40 A	53 A	65 A	80 A	96 A
	440 V	40 A	53 A	65 A	80 A	96 A
	500 V	35 A	45 A	55 A	65 A	80 A
	690 V	25 A	35 A	39 A	49 A	57 A
	1000 V	-	-	-	25 A	30 A
Rated operational power AC-3 (1)						
	220-230-240 V	11 kW	15 kW	18.5 kW	22 kW	25 kW
	380-400 V	18.5 kW	22 kW	30 kW	37 kW	45 kW
	415 V	22 kW	30 kW	37 kW	45 kW	55 kW
	440 V	22 kW	30 kW	37 kW	45 kW	55 kW
	500 V	22 kW	30 kW	37 kW	45 kW	55 kW
	690 V	22 kW	30 kW	37 kW	45 kW	55 kW
	1000 V	-	-	-	35 kW	40 kW
Rated making capacity AC-3		10 x I _e AC-3 acc. to IEC 60947-4-1				
Rated breaking capacity AC-3		8 x I _e AC-3 acc. to IEC 60947-4-1				
AC-8a Utilization category						
(without thermal overload relay - U _e 400 V 50/60 Hz - $\theta \leq 40\text{ °C}$)						
I_e / Rated operational current AC-8a		53 A	70 A	85 A	105 A	120 A
Rated operational power AC-8a		25 kW	37 kW	45 kW	55 kW	65 kW
Short-circuit protection device for contactors						
without thermal overload relay - Motor protection excluded (2)						
U _e $\leq 500\text{ V}$ AC - gG type fuse		100 A	125 A	160 A	160 A	200 A
Rated short-time withstand current I_{cw}						
at 40 °C ambient temperature,	1 s	1000 A	1000 A	1000 A	1200 A	1200 A
in free air from a cold state	10 s	600 A	600 A	600 A	780 A	780 A
	30 s	350 A	350 A	350 A	450 A	450 A
	1 min	250 A	250 A	250 A	300 A	300 A
	15 min	110 A	110 A	110 A	140 A	140 A
Maximum breaking capacity						
cos $\phi = 0.45$	at 440 V	950 A	950 A	950 A	1150 A	1150 A
	at 690 V	600 A	600 A	600 A	750 A	750 A
Power dissipation per pole						
	I _e / AC-1	3 W	6.3 W	7 W	7.6 W	8.2 W
	I _e / AC-3	1 W	1.7 W	2.7 W	3 W	4.5 W
Max. electrical switching frequency						
	AC-1	600 cycles/h				
	AC-3	1200 cycles/h				
	AC-2, AC-4	150 cycles/h				



3-phase motors



1500 r.p.m. 50 Hz
1800 r.p.m. 60 Hz
3-phase motors

(1) For the corresponding kW/A or hp/A values of 1500 r.p.m, 50 Hz or 1800 r.p.m, 60 Hz, 3-phase motors, see "Motor rated operational powers and currents".

(2) For the protection of motor starters against short circuits, see "Coordination with short-circuit protection devices".

AF116 ... AF370 3-pole contactors

Technical data

Main pole - Utilization characteristics according to IEC

Contactor types	AC / DC operated	AF116	AF140	AF146	AF190	AF205	AF265	AF305	AF370
Standards		IEC 60947-1 / 60947-4-1 and EN 60947-1 / 60947-4-1							
Rated operational voltage U_e max.		690 V	690 V	1000 V	1000 V	1000 V	1000 V	1000 V	1000 V
Rated frequency (without derating)		50 / 60 Hz							
Conventional free-air thermal current I_{th}									
acc. to IEC 60947-4-1, open contactors, $\theta \leq 40^\circ\text{C}$		160 A	200 A	225 A	275 A	350 A	400 A	500 A	600 A
With conductor cross-sectional area		70 mm ²	95 mm ²	95 mm ²	150 mm ²	240 mm ² (3)	240 mm ²	300 mm ² (4)	2 x 185 mm ² (4)
AC-1 Utilization category									
For air temperature close to contactor									
I_e / Rated operational current AC-1									
$\theta \leq 40^\circ\text{C}$		160 A	200 A	225 A	275 A	350 A	400 A	500 A	600 A
$\theta \leq 60^\circ\text{C}$		145 A	175 A	200 A	250 A	300 A	350 A	400 A	500 A
$\theta \leq 70^\circ\text{C}$		130 A	160 A	175 A	200 A	240 A	290 A	325 A	400 A
I_e / Rated operational current AC-1									
$\theta \leq 40^\circ\text{C}$		—	—	225 A	250 A	275 A	350 A	375 A	400 A
$\theta \leq 60^\circ\text{C}$		—	—	200 A	225 A	250 A	300 A	325 A	350 A
$\theta \leq 70^\circ\text{C}$		—	—	175 A	185 A	200 A	240 A	260 A	290 A
With conductor cross-sectional area		70 mm ²	95 mm ²	95 mm ²	150 mm ²	240 mm ² (3)	240 mm ²	300 mm ² (4)	2 x 185 mm ² (4)
AC-3 Utilization category									
For air temperature close to contactor $\theta \leq 60^\circ\text{C}$									
I_e / Max. rated operational current AC-3 (1)									
220-230-240 V		116 A	140 A	146 A	190 A	205 A	265 A	305 A	370 A
380-400 V		116 A	140 A	146 A	190 A	205 A	265 A	305 A	370 A
415 V		116 A	140 A	146 A	190 A	205 A	265 A	305 A	370 A
440 V		116 A	140 A	146 A	190 A	205 A	265 A	305 A	370 A
500 V		110 A	130 A	130 A	135 A	165 A	250 A	290 A	315 A
690 V		65 A	80 A	93 A	135 A	165 A	250 A	290 A	315 A
1000 V		—	—	60 A	85 A	100 A	100 A	100 A	100 A
Rated operational power AC-3 (1)									
220-230-240 V		30 kW	37 kW	45 kW	55 kW	55 kW	75 kW	90 kW	110 kW
380-400 V		55 kW	75 kW	75 kW	90 kW	110 kW	132 kW	160 kW	200 kW
415 V		55 kW	75 kW	75 kW	90 kW	110 kW	132 kW	160 kW	200 kW
440 V		75 kW	90 kW	90 kW	110 kW	132 kW	160 kW	160 kW	200 kW
500 V		75 kW	90 kW	90 kW	90 kW	110 kW	200 kW	200 kW	250 kW
690 V		55 kW	75 kW	90 kW	132 kW	160 kW	200 kW	250 kW	315 kW
1000 V		—	—	75 kW	110 kW	132 kW	132 kW	132 kW	132 kW
Rated making capacity AC-3		10 x I_e AC-3 acc. to IEC 60947-4-1							
Rated breaking capacity AC-3		8 x I_e AC-3 acc. to IEC 60947-4-1							
Short-circuit protection device for contactors									
without thermal overload relay - Motor protection excluded (2)									
$U_e \leq 500\text{ V AC}$ - gG type fuse		250 A	315 A	315 A	355 A	400 A	500 A	500 A	630 A
Rated short-time withstand current I_{cw}									
1 s		1300 A	1460 A	1460 A	1900 A	2050 A	2650 A	3050 A	3700 A
10 s		928 A	1168 A	1168 A	1520 A	1640 A	2120 A	2440 A	2960 A
30 s		536 A	674 A	674 A	878 A	947 A	1224 A	1409 A	1709 A
1 min		379 A	477 A	477 A	621 A	670 A	865 A	996 A	1208 A
15 min		160 A	200 A	225 A	275 A	350 A	400 A	500 A	600 A
Maximum breaking capacity									
$\cos \varphi = 0.45$									
at 440 V		2000 A	3000 A	3000 A	3300 A	3500 A	3800 A	4600 A	5000 A
at 690 V		1000 A	1500 A	1500 A	2200 A	2500 A	3300 A	3800 A	4000 A
($\cos \varphi = 0.35$ for $I_e > 100\text{ A}$)									
Power dissipation per pole									
I_e / AC-1		12 W	18 W	23 W	15 W	25 W	32 W	50 W	72 W
I_e / AC-3		6 W	9 W	10 W	7 W	8 W	14 W	19 W	27 W
Maximum electrical switching frequency									
AC-1		300 cycles/h							
AC-3		300 cycles/h							
AC-2, AC-4		150 cycles/h							



3-phase motors



1500 r.p.m. 50 Hz
1800 r.p.m. 60 Hz
3-phase motors

(1) For the corresponding kW/A or hp/A values of 1500 r.p.m., 50 Hz or 1800 r.p.m., 60 Hz, 3-phase motors, see "Motor rated operational powers and currents".

(2) For the protection of motor starters against short circuits, see "Coordination with short-circuit protection devices".

(3) For currents above 275A use terminal enlargements or terminal extensions.

(4) For currents above 450A use terminal enlargements or terminal extensions.

AF400 ... AF2650 3-pole contactors

Technical data

Main pole - Utilization characteristics according to IEC

Contactor types	AC / DC operated	AF400	AF460	AF580	AF750	AF1250	AF1350	AF1650	AF2050	AF2650
Standards		IEC 60947-1 / 60947-4-1 and EN 60947-1 / 60947-4-1								
Rated operational voltage U _e max.		1000 V								
Rated frequency (without derating)		50/60 Hz								
Conventional free-air thermal current I _{th}										
acc. to IEC 60947-4-1, open contactors, $\theta \leq 40^\circ\text{C}$		600 A	700 A	800 A	1050 A	1260 A	1350 A	1650 A	2050 A	2650 A
With conductor cross-sectional area (3)		2x185 mm ²	2x240 mm ²	2x240 mm ²	800 mm ² (4)	1000 mm ² (4)	1000 mm ² (5)	1500 mm ² (5)	2000 mm ² (5)	3000 mm ² (5)
AC-1 Utilization category										
For air temperature close to contactor										
I_e / Rated operational current AC-1	$\theta \leq 40^\circ\text{C}$	600 A	700 A	800 A	1050 A	1260 A	1350 A	1650 A	2050 A	2650 A
U _e max. $\leq 690\text{ V}$, 50/60 Hz	$\theta \leq 55^\circ\text{C}$	500 A	600 A	700 A	875 A	1040 A	1150 A	1450 A	1750 A	2350 A
	$\theta \leq 70^\circ\text{C}$	400 A	480 A	580 A	720 A	875 A	1000 A	1270 A	1500 A	2120 A
I_e / Rated operational current AC-1	$\theta \leq 40^\circ\text{C}$	600 A	700 A	800 A	1000 A	1260 A	1350 A	1650 A	2050 A	2650 A
U _e max. $\leq 1000\text{ V}$, 50/60 Hz	$\theta \leq 55^\circ\text{C}$	500 A	600 A	700 A	875 A	1040 A	1150 A	1450 A	1750 A	2350 A
	$\theta \leq 70^\circ\text{C}$	400 A	480 A	580 A	720 A	875 A	1000 A	1270 A	1500 A	2120 A
With conductor cross-sectional area		2x185 mm ²	2x240 mm ²	2x240 mm ²	800 mm ² (4)	1000 mm ² (4)	1000 mm ² (5)	1500 mm ² (5)	2000 mm ² (5)	3000 mm ² (5)
AC-3 Utilization category										
For air temperature close to contactor $\theta \leq 55^\circ\text{C}$										
I_e / Max. rated operational current AC-3 (1)										
	220-230-240 V	400 A	460 A	580 A	750 A	–	860 A	1060 A	1060 A	–
	380-400 V	400 A	460 A	580 A	750 A	–	860 A	1060 A	1060 A	–
	415 V	400 A	460 A	580 A	750 A	–	860 A	1060 A	1060 A	–
	440 V	400 A	460 A	580 A	750 A	–	860 A	1060 A	1060 A	–
	500 V	400 A	460 A	580 A	750 A	–	800 A	970 A	970 A	–
	690 V	350 A	400 A	500 A	650 A	–	800 A	970 A	970 A	–
	1000 V	155 A	200 A	250 A	300 A	–	–	–	–	–
Rated operational power AC-3 (1)										
	220-230-240 V	110 kW	132 kW	160 kW	220 kW	–	257 kW	315 kW	–	–
	380-400 V	200 kW	250 kW	315 kW	400 kW	–	475 kW	560 kW	–	–
	415 V	220 kW	250 kW	355 kW	425 kW	–	500 kW	630 kW	630 kW	–
	440 V	220 kW	250 kW	355 kW	450 kW	–	560 kW	710 kW	710 kW	–
	500 V	250 kW	315 kW	400 kW	520 kW	–	560 kW	710 kW	–	–
	690 V	315 kW	355 kW	500 kW	600 kW	–	800 kW	1000 kW	1000 kW	–
	1000 V	220 kW	280 kW	355 kW	400 kW	–	–	–	–	–
Rated making capacity AC-3		10 x I _e AC-3 acc. to IEC 60947-4-1								
Rated breaking capacity AC-3		8 x I _e AC-3 acc. to IEC 60947-4-1								
Short-circuit protection device for contactors										
without thermal overload relay										
Motor protection excluded (2)										
U _e $\leq 500\text{ V}$ AC - gG type fuse		630 A	800 A	1000 A	1000 A	Please consult us for coordination with circuit-breaker				
Rated short-time withstand current I_{sw}	1 s	4600 A	4600 A	7000 A	7000 A	8000 A	10000 A	12000 A	12000 A	12000 A
	10 s	4400 A	4400 A	6400 A	6400 A	7200 A	8000 A	10000 A	10000 A	10000 A
	30 s	3100 A	3100 A	4500 A	4500 A	5200 A	6000 A	7500 A	7500 A	7500 A
	1 min	2500 A	2500 A	3500 A	3500 A	4000 A	4500 A	5500 A	5500 A	5500 A
	15 min	840 A	840 A	1300 A	1300 A	1500 A	1600 A	2200 A	2200 A	2800 A
Maximum breaking capacity										
cos $\phi = 0.45$	at 440 V	4000 A	5000 A	6000 A	7500 A	–	10000 A	12000 A	8400 A	8400 A
(cos $\phi = 0.35$ for I _e > 100 A)	at 690 V	3500 A	4500 A	5000 A	7000 A	–	–	–	–	–
Power dissipation per pole										
	I _e / AC-1	30 W	42 W	32 W	50 W	80 W	80 W	80 W	125 W	200 W
	I _e / AC-3	16 W	21 W	17 W	28 W	–	50 W	50 W	–	–
Max. electrical switching frequency										
	AC-1	300 cycles/h			300 cycles/h		300 cycles/h		60 cycles/h	
	AC-3	300 cycles/h			300 cycles/h		–		60 cycles/h	
	AC-2, AC-4	60 cycles/h			60 cycles/h		–		60 cycles/h	

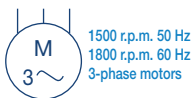

(1) For the corresponding kW/A or hp/A values of 1500 r.p.m, 50 Hz or 1800 r.p.m, 60 Hz, 3-phase motors, see "Motor rated operational powers and currents".

(2) For the protection of motor starters against short circuits, see "Coordination with short-circuit protection devices".

(3) Conductors with preparation.

(4) Max. connection bar width 50 mm.

(5) Max. connection bar width 100 mm.

AF09 ... AF38 3-pole contactors

Technical data

Main pole - Utilization characteristics according to UL / NEMA / CSA

Contactors types	AC / DC operated	AF09	AF12	AF16	AF26	AF30	AF38
Standards		UL 508, CSA C22.2 N°60947-4-1					
Max. operational voltage		600 V					
NEMA size		00	0	-	1	-	-
NEMA continuous amp rating	Thermal current	9 A	18 A		27 A		
NEMA maximum horse power ratings							
1-phase, 60 Hz	115 V AC	1/3 hp	1 hp		2 hp		
	230 V AC	1 hp	2 hp		3 hp		
NEMA maximum horse power ratings							
3-phase, 60 Hz	200 V AC	1-1/2 hp	3 hp		7-1/2 hp		
	230 V AC	1-1/2 hp	3 hp		7-1/2 hp		
	460 V AC	2 hp	5 hp		10 hp		
	575 V AC	2 hp	5 hp		10 hp		
UL / CSA general use rating							
	600 V AC	25 A	28 A	30 A	45 A	50 A	50 A
With conductor cross-sectional area		AWG 10	AWG 10	AWG 10	AWG 8	AWG 8	AWG 8
1 pole	80 V DC	25 A	28 A	30 A	45 A	50 A	50 A
2 poles in serie	160 V DC	25 A	28 A	30 A	45 A	50 A	50 A
3 poles in serie	240 V DC	25 A	28 A	30 A	45 A	50 A	50 A
With conductor cross-sectional area		AWG 10	AWG 10	AWG 10	AWG 8	AWG 8	AWG 8
UL / CSA maximum 1-phase motor rating							
Full load current	120 V AC	13.8 A	16 A	20 A	24 A	24 A	24 A
	240 V AC	10 A	12 A	17 A	17 A	28 A	28 A
Horse power rating	120 V AC	3/4 hp	1 hp	1-1/2 hp	2 hp	2 hp	2 hp
	240 V AC	1-1/2 hp	2 hp	3 hp	3 hp	5 hp	5 hp
UL / CSA maximum 3-phase motor rating							
Full load current (1)	200-208 V AC	7.8 A	11 A	17.5 A	25.3 A	32.2 A	32.2 A
	220-240 V AC	6.8 A	9.6 A	15.2 A	22 A	28 A	28 A
	440-480 V AC	7.6 A	11 A	14 A	21 A	27 A	34 A (3)
	550-600 V AC	9 A	11 A	17 A	22 A	27 A (2)	32 A (3)
Horse power rating (1)	200-208 V AC	2 hp	3 hp	5 hp	7-1/2 hp	10 hp	10 hp
	220-240 V AC	2 hp	3 hp	5 hp	7-1/2 hp	10 hp	10 hp
	440-480 V AC	5 hp	7-1/2 hp	10 hp	15 hp	20 hp	25 hp (3)
	550-600 V AC	7-1/2 hp	10 hp	15 hp	20 hp	25 hp (2)	30 hp (3)
UL / CSA - DC motor starting - 3 poles in series							
Full Load Amps (FLA)	125 V DC	9.5 A	13.2 A	17 A	25 A	25 A	25 A
	250 V DC	8.5 A	12.2 A	12.2 A	20 A	29 A	29 A
Horse power rating	125 V DC	1 hp	1-1/2 hp	2 hp	3 hp	3 hp	3 hp
	250 V DC	2 hp	3 hp	3 hp	5 hp	7-1/2 hp	7-1/2 hp
Short-circuit protection device for contactors							
without thermal overload relay - Motor protection excluded							
High fault current		100 kA					
Fuse rating		30 A	30 A	60 A	60 A	100 A	100 A
Fuse type, 600 V		J					
Max. electrical switching frequency							
For general use		600 cycles/h					
For motor use		1200 cycles/h					

(1) For the corresponding kW/A or hp/A values of 1500 r.p.m, 50 Hz or 1800 r.p.m, 60 Hz, 3-phase motors, see "Motor rated operational powers and currents".

(2) For contactors produced since week 49-2011.

(3) For contactors produced since week 36-2014.

AF40 ... AF96 3-pole contactors

Technical data

Main pole - Utilization characteristics according to UL / NEMA / CSA

Contactor types	AC / DC operated	AF40	AF52	AF65	AF80	AF96	
Standards		UL 60947-4-1, CSA C22.2 N°60947-4-1					
Maximum operational voltage		600 V					
NEMA size		2	-	-	3	-	
NEMA continuous amp rating	Thermal current	45 A	-	-	90 A	-	
NEMA maximum horse power ratings 1-phase, 60 Hz	115 V AC	3 hp	-	-	-	-	
	230 V AC	7.5 hp	-	-	-	-	
NEMA maximum horse power ratings 3-phase, 60 Hz	200 V AC	10 hp	-	-	25 hp	-	
	230 V AC	15 hp	-	-	30 hp	-	
	460 V AC	25 hp	-	-	50 hp	-	
	575 V AC	25 hp	-	-	50 hp	-	
UL / CSA general use rating	600 V AC	60 A	80 A	90 A	105 A	115 A	
	With conductor cross-sectional area	AWG 6	AWG 4	AWG 3	AWG 2	AWG 2	
	1 pole	80 V DC	60 A	80 A	90 A	105 A	115 A
	2 poles in serie	160 V DC	60 A	80 A	90 A	105 A	115 A
	3 poles in serie	240 V DC	60 A	80 A	90 A	105 A	115 A
	With conductor cross-sectional area		AWG 6	AWG 4	AWG 3	AWG 2	AWG 2
	UL / CSA maximum 1-phase motor rating						
Full load current	120 V AC	34 A	34 A	56 A	80 A	80 A	
	240 V AC	40 A	50 A	68 A	68 A	88 A	
Horse power rating	120 V AC	3 hp	3 hp	5 hp	7-1/2 hp	7-1/2 hp	
	240 V AC	7-1/2 hp	10 hp	15 hp	15 hp	20 hp	
UL / CSA maximum 3-phase motor rating	200-208 V AC	32.2 A	48.3 A	62.1 A	78.2 A	92 A	
	220-240 V AC	42 A	54 A	68 A	80 A	80 A	
	440-480 V AC	40 A	52 A	65 A	77 A	77 A	
	550-600 V AC	41 A	52 A	62 A	77 A	77 A	
	Horse power rating (1)	200-208 V AC	10 hp	15 hp	20 hp	25 hp	30 hp
		220-240 V AC	15 hp	20 hp	25 hp	30 hp	30 hp
		440-480 V AC	30 hp	40 hp	50 hp	60 hp	60 hp
550-600 V AC	40 hp	50 hp	60 hp	75 hp	75 hp		
UL / CSA - DC motor starting - 3 poles in series	Full Load Amps (FLA)						
	125 V DC	40 A	58 A	76 A	76 A	110 A	
	250 V DC	38 A	55 A	72 A	89 A	106 A	
	Horse power rating	125 V DC	5 hp	7-1/2 hp	10 hp	10 hp	15 hp
250 V DC	10 hp	15 hp	20 hp	25 hp	30 hp		
Short-circuit protection device for contactors							
without thermal overload relay - Motor protection excluded							
High fault current		100 kA					
Fuse rating		150 A	150 A	150 A	200 A	200 A	
Fuse type, 600 V		J					
Maximum electrical switching frequency							
For general use		600 cycles/h					
For motor use		1200 cycles/h					

(1) For the corresponding kW/A or hp/A values of 1500 r.p.m, 50 Hz or 1800 r.p.m, 60 Hz, 3-phase motors, see "Motor rated operational powers and currents".

AF116 ... AF370 3-pole contactors

Technical data

Main pole - Utilization characteristics according to UL / NEMA / CSA

Contactor types	AC / DC operated	AF116	AF140	AF146	AF190	AF205	AF265	AF305	AF370
Standards		UL 60947-1 / 60947-4-1A and CSA 60947-1 / 60947-4-1A							
Maximum operational voltage		600V							
NEMA size		—	4	—	—	—	5	—	—
NEMA continuous amp rating	Thermal current	—	135 A	—	—	—	270 A	—	—
NEMA maximum horse power ratings									
1-phase, 60 Hz	115 V AC	—	—	—	—	—	—	—	—
	230 V AC	—	—	—	—	—	—	—	—
NEMA maximum horse power ratings									
3-phase, 60 Hz	200 V AC	—	40 hp	—	—	—	75 hp	—	—
	230 V AC	—	50hp	—	—	—	100 hp	—	—
	460 V AC	—	100 hp	—	—	—	200 hp	—	—
	575 V AC	—	100 hp	—	—	—	200 hp	—	—
UL / CSA general use rating									
600 V AC		160 A	200 A	200 A	250 A	300 A	350 A	400 A	520 A
With conductor cross-sectional area		AWG 2/0	AWG 3/0	AWG 3/0	MCM 250	MCM 350 (2)	MCM 500	2//AWG 3/0	2//MCM 300
1 pole	90 V DC	160 A	200 A	200 A	—	—	—	—	—
	100 V DC	—	—	—	250 A	350 A	—	—	—
	110 V DC	—	—	—	—	—	400 A	500 A	520 A
2 poles in serie	175 V DC	160 A	200 A	200 A	—	—	—	—	—
	200 V DC	—	—	—	250 A	350 A	—	—	—
	225 V DC	—	—	—	—	—	400 A	500 A	520 A
3 poles in serie	260 V DC	160 A	200 A	200 A	—	—	—	—	—
	300 V DC	—	—	—	250 A	350 A	—	—	—
	340 V DC	—	—	—	—	—	400 A	500 A	520 A
With conductor cross-sectional area		AWG 2/0	AWG 3/0	AWG 3/0	MCM 250	MCM 350 (2)	MCM 500	2//AWG 3/0	2//MCM 300
UL / CSA maximum 1-phase motor rating									
Full load current	120 V AC	—	—	—	—	—	—	—	—
	240 V AC	—	—	—	—	—	—	—	—
Horse power rating	120 V AC	—	—	—	—	—	—	—	—
	240 V AC	—	—	—	—	—	—	—	—
UL / CSA maximum 3-phase motor rating									
Full load current (1)	200-208 V AC	92 A	120 A	120 A	150 A	177 A	221 A	285 A	359 A
	220-240 V AC	104 A	130 A	130 A	154 A	192 A	248 A	312 A	360 A
	440-480 V AC	96 A	124 A	124 A	156 A	180 A	240 A	302 A	361 A
	550-600 V AC	99 A	125 A	125 A	144 A	192 A	242 A	289 A	336 A
Horse power rating (1)	200-208 V AC	30 hp	40 hp	40 hp	50 hp	60 hp	75 hp	100 hp	125 hp
	220-240 V AC	40 hp	50 hp	50 hp	60 hp	75 hp	100 hp	125 hp	150 hp
	440-480 V AC	75 hp	100 hp	100 hp	125 hp	150 hp	200 hp	250 hp	300 hp
	550-600 V AC	100 hp	125 hp	125 hp	150 hp	200 hp	250 hp	300 hp	350 hp
Short-circuit protection device for contactors									
without thermal overload relay - Motor protection excluded									
High fault current		100 kA							
Fuse rating		225 A	250 A	250 A	450 A	400 A	500 A	600 A	800 A
Fuse type, 600 V		J							
Maximum electrical switching frequency									
For general use		300 cycles/h							
For motor use		300 cycles/h							

(1) For the corresponding kW/A or hp/A values of 1500 r.p.m, 50 Hz or 1800 r.p.m, 60 Hz, 3-phase motors, see "Motor rated operational powers and currents".

(2) For conductor cross-sectional area above MCM 300 use terminal enlargements LW205.

AF400 ... AF2650 3-pole contactors

Technical data

Main pole - Utilization characteristics according to UL / NEMA / CSA

Contactor types	AC / DC operated	AF400	AF460	AF580	AF750	AF1250	AF1350	AF1650	AF2050	AF2650	
Standards		UL 508, CSA C22.2 N°14									
Maximum operational voltage		600 V					1000 V				
NEMA size		-	6	-	7	-	-	8	-	-	
NEMA maximum horse power ratings											
1-phase, 60 Hz	115 V AC	-	-	-	-	-	-	-	-	-	
	230 V AC	-	-	-	-	-	-	-	-	-	
NEMA maximum horse power ratings											
3-phase, 60 Hz	200 V AC	-	150 hp	-	-	-	-	-	-	-	
	230 V AC	-	200 hp	-	300 hp	-	-	450 hp	-	-	
	460 V AC	-	400 hp	-	600 hp	-	-	900 hp	-	-	
	575 V AC	-	400 hp	-	600 hp	-	-	900 hp	-	-	
UL / CSA general use rating											
1000 V AC		550 A	650 A	750 A	900 A	1210 A	1350 A	1650 A	2100 A	2700 A	
UL / CSA maximum 1-phase motor rating											
Full load current	120 V AC	-	-	-	-	-	-	-	-	-	
	240 V AC	-	-	-	-	-	-	-	-	-	
Horse power rating	120 V AC	-	-	-	-	-	-	-	-	-	
	240 V AC	-	-	-	-	-	-	-	-	-	
UL / CSA maximum 3-phase motor rating											
Full load current (1)	200-208 V AC	358.8 A	414 A	552 A	692.3 A	-	954 A	1030 A	-	-	
	220-240 V AC	360 A	480 A	604 A	722 A	-	954 A	1030 A	-	-	
	440-480 V AC	414 A	477 A	590 A	722 A	-	954 A	1030 A	-	-	
	550-600 V AC	382 A	472 A	578 A	672 A	-	944 A	1050 A	-	-	
Horse power rating (1)	200-208 V AC	125 hp	150 hp	200 hp	250 hp	-	-	-	-	-	
	220-240 V AC	150 hp	200 hp	250 hp	300 hp	-	400 A	450 hp	-	-	
	440-480 V AC	350 hp	400 hp	500 hp	600 hp	-	800 A	900 hp	-	-	
	550-600 V AC	400 hp	500 hp	600 hp	700 hp	-	1000 A	1150 hp	-	-	
Short-circuit protection device for contactors											
without thermal overload relay - Motor protection excluded											
Fuse rating		1000 A		1200 A			Please consult us for coordination with circuit-breaker				
Fuse type, 600 V		L									
Maximum electrical switching frequency											
For general use		300 cycles/h					60 cycles/h			15 cycles/h	
For motor use		300 cycles/h					60 cycles/h			-	

(1) For the corresponding kW/A or hp/A values of 1500 r.p.m, 50 Hz or 1800 r.p.m, 60 Hz, 3-phase motors, see "Motor rated operational powers and currents".

AF09 ... AF96 3-pole contactors

Technical data

Main pole utilization characteristics - 3 N.O. non-reversing contactors

Contactor types	AC / DC operated	AF09	AF12	AF16	AF26	AF30	AF38	AF40	AF52	AF65	AF80	AF96
HVAC application - UL / CSA												
Definite purpose heating rating - 3-phase												
Full Load Amps (FLA)		20 A	25 A	30 A	45 A	50 A	50 A	60 A	80 A	90 A	105 A	115 A
Locked Rotor Amps (LRA)	200-208 V AC	120 A	150 A	180 A	270 A	300 A	300 A	360 A	480 A	540 A	630 A	690 A
	220-240 V AC	120 A	150 A	180 A	270 A	300 A	300 A	360 A	480 A	540 A	630 A	690 A
	440-480 V AC	120 A	150 A	180 A	270 A	300 A	300 A	360 A	480 A	540 A	630 A	690 A
	550-600 V AC	80 A	100 A	120 A	180 A	200 A	200 A	240 A	320 A	360 A	420 A	460 A
Definite purpose air conditioning rating - 3-phase												
Full Load Amps (FLA)		20 A	25 A	30 A	45 A	50 A	50 A	60 A	80 A	90 A	105 A	115 A
Locked Rotor Amps (LRA)	200-208 V AC	120 A	150 A	180 A	270 A	300 A	300 A	360 A	480 A	540 A	630 A	690 A
	220-240 V AC	120 A	150 A	180 A	270 A	300 A	300 A	360 A	480 A	540 A	630 A	690 A
	440-480 V AC	120 A	150 A	180 A	270 A	300 A	300 A	360 A	480 A	540 A	630 A	690 A
	550-600 V AC	80 A	100 A	120 A	180 A	200 A	200 A	240 A	320 A	360 A	420 A	460 A
AC Resistance air heating												
Full Load Amps (FLA)	600 V AC	20 A	25 A	30 A	45 A	50 A	50 A	65 A	80 A	90 A	105 A	115 A
Elevator control, load switching, 500 000 electrical operating cycles												
acc. to CSA B44.1 / ASME 17.5 paragraph 19.2.1												
1-phase												
Horse power rating	110-120 V AC	1/4 hp	1/3 hp	(1)	1-1/2 hp	2 hp	2 hp	3 hp	3 hp	3 hp	5 hp	5 hp
	220-240 V AC	1/2 hp	3/4 hp	(1)	3 hp	3 hp	5 hp	5 hp	7-1/2 hp	10 hp	10 hp	10 hp
3-phase												
Horse power rating	200-208 V AC	1 hp	2 hp	(1)	5 hp	7-1/2 hp	7-1/2 hp	10 hp	10 hp	15 hp	15 hp	15 hp
	220-240 V AC	1 hp	2 hp	(1)	5 hp	7-1/2 hp	10 hp	10 hp	15 hp	20 hp	20 hp	20 hp
	440-480 V AC	3 hp	5 hp	(1)	15 hp	20 hp	20 hp	25 hp	30 hp	40 hp	40 hp	40 hp
	550-600 V AC	3 hp	5 hp	(1)	15 hp	20 hp	20 hp	30 hp	40 hp	40 hp	50 hp	50 hp
Elevator control, 500 000 mechanical operating cycles, 5 electrical operating cycles												
acc. to CSA B44.1 / ASME 17.5 paragraph 19.2.2												
1-phase												
Horse power rating	110-120 V AC	3/4 hp	1 hp	1-1/2 hp	2 hp	2 hp	3 hp	3 hp	3 hp	5 hp	7-1/2 hp	7-1/2 hp
	220-240 V AC	1-1/2 hp	2 hp	3 hp	3 hp	5 hp	7.5 hp	7-1/2 hp	7-1/2 hp	10 hp	15 hp	20 hp
3-phase												
Horse power rating	200-208 V AC	2 hp	3 hp	5 hp	7-1/2 hp	10 hp	10 hp	10 hp	15 hp	20 hp	25 hp	30 hp
	220-240 V AC	2 hp	3 hp	5 hp	7-1/2 hp	10 hp	10 hp	15 hp	20 hp	25 hp	30 hp	30 hp
	440-480 V AC	5 hp	7-1/2 hp	10 hp	15 hp	20 hp	25 hp	30 hp	40 hp	50 hp	60 hp	60 hp
	550-600 V AC	7-1/2 hp	10 hp	15 hp	20 hp	25 hp	30 hp	40 hp	50 hp	60 hp	75 hp	75 hp
Lighting application - UL / CSA												
Tungsten lamps												
1-phase per pole	347 V AC	20 A	25 A	30 A	45 A	50 A	50 A	65 A	80 A	90 A	105 A	115 A
3-phase break all lines	600 V AC	20 A	25 A	30 A	45 A	50 A	50 A	65 A	80 A	90 A	105 A	115 A
Electrical discharge lamps (ballast)												
1-phase per pole	347 V AC	20 A	25 A	30 A	45 A	50 A	50 A	65 A	80 A	90 A	105 A	115 A
3-phase break all lines	600 V AC	20 A	25 A	30 A	45 A	50 A	50 A	65 A	80 A	90 A	105 A	115 A

(1) 3-pole AF16 cannot be used. Select 4-pole non-reversing contactor AF16.-40-..

AF116 ... AF370 3-pole contactors

Technical data

Main pole utilization characteristics - 3 N.O. non-reversing contactors

Contactor types	AC / DC operated	AF116	AF140	AF146	AF190	AF205	AF265	AF305	AF370
HVAC application - UL / CSA									
Definite purpose heating rating - 3-phase									
Full Load Amps (FLA)		116 A	125 A	160 A	200 A	250 A	300 A	350 A	520 A
Locked Rotor Amps (LRA)	200-208 V AC	800 A	875 A	1050 A	1400 A	1500 A	2100 A	2450 A	3120 A
	220-240 V AC	800 A	875 A	1050 A	1400 A	1500 A	2100 A	2450 A	3120 A
	440-480 V AC	800 A	875 A	1050 A	1400 A	1500 A	2100 A	2450 A	3120 A
	550-600 V AC	800 A	875 A	1050 A	1400 A	1500 A	2100 A	2450 A	3120 A
Definite purpose air conditioning rating - 3-phase									
Full Load Amps (FLA)		116 A	125 A	160 A	200 A	250 A	300 A	350 A	520 A
Locked Rotor Amps (LRA)	200-208 V AC	800 A	875 A	1050 A	1400 A	1500 A	2100 A	2450 A	3120 A
	220-240 V AC	800 A	875 A	1050 A	1400 A	1500 A	2100 A	2450 A	3120 A
	440-480 V AC	800 A	875 A	1050 A	1400 A	1500 A	2100 A	2450 A	3120 A
	550-600 V AC	800 A	875 A	1050 A	1400 A	1500 A	2100 A	2450 A	3120 A
AC Resistance air heating									
Full Load Amps (FLA)	600 V AC	160 A	200 A	200 A	250 A	300 A	400 A	450 A	520 A
Elevator control, load switching, 500 000 electrical operating cycles									
acc. to CSA B44.1 / ASME 17.5 paragraph 19.2.1									
3-phase									
Horse power rating	200-208 V AC	15 hp	15 hp	15 hp	-	-	-	-	-
	220-240 V AC	20 hp	20 hp	20 hp	-	-	-	-	-
	440-480 V AC	40 hp	40 hp	40 hp	-	-	-	-	-
	550-600 V AC	50 hp	50 hp	50 hp	-	-	-	-	-
Elevator control, 500 000 mechanical operating cycles, 5 electrical operating cycles									
acc. to CSA B44.1 / ASME 17.5. paragraph 19.2.2									
3-phase									
Horse power rating	200-208 V AC	30 hp	40 hp	40 hp	50 hp	60 hp	75 hp	100 hp	125 hp
	220-240 V AC	40 hp	50 hp	50 hp	60 hp	75 hp	100 hp	125 hp	150 hp
	440-480 V AC	75 hp	100 hp	100 hp	125 hp	150 hp	200 hp	250 hp	300 hp
	550-600 V AC	100 hp	125 hp	125 hp	150 hp	200 hp	250 hp	300 hp	350 hp
Lighting application - UL / CSA									
Tungsten lamps									
1-phase per pole	347 V AC	-	-	-	-	-	-	-	-
3-phase break all lines	600 V AC	-	-	-	-	-	-	-	-
Electrical discharge lamps (ballast)									
1-phase per pole	347 V AC	160 A	200 A	200 A	250 A	300 A	400 A	450 A	520 A
3-phase break all lines	600 V AC	160 A	200 A	200 A	250 A	300 A	400 A	450 A	520 A

AF09 ... AF38 3-pole contactors

Technical data

General technical data

Contactor types	AC / DC operated	AF09	AF12	AF16	AF26	AF30	AF38
Rated insulation voltage U_i acc. to IEC 60947-4-1 acc. to UL / CSA		690 V 600 V					
Rated impulse withstand voltage U_{imp}		6 kV					
Electromagnetic compatibility		Devices complying with IEC 60947-1 / EN 60947-1 - Environment A and B (1)					
Ambient air temperature close to contactor							
Operation	Fitted with thermal overload relay	-25...+60 °C					
	Without thermal overload relay	-40...+70 °C					
Storage		-60...+80 °C					
Climatic withstand		Category B according to IEC 60947-1 Annex Q					
Maximum operating altitude (without derating)		3000 m					
Mechanical durability							
Number of operating cycles		10 millions operating cycles					
Max. switching frequency		3600 cycles/h					
Shock withstand acc. to IEC 60068-2-27 and EN 60068-2-27 Mounting position 1							
	Shock direction	1/2 sinusoidal shock for 11 ms: no change in contact position, closed or open position					
	A	30 g					
	B1	25 g closed position / 5 g open position					
	B2	15 g					
	C1	25 g					
	C2	25 g					
Vibration withstand acc. to IEC 60068-2-6							
		5...300 Hz 4 g closed position / 2 g open position					

(1) Environment B: all AF09 ... AF38 contactors produced since week 08-2013. AF09 ... AF38-...-12 (48...130 V 50/60 Hz-DC) compliant to environment A only.
For environment B: select AF09 ... AF38-...-22.

Magnet system characteristics

Contactor types	AC / DC operated	AF09	AF12	AF16	AF26	AF30	AF38
Coil operating limits acc. to IEC 60947-4-1	AC supply	At $\theta \leq 60$ °C $0.85 \times U_c \text{ min...} 1.1 \times U_c \text{ max.}$ At $\theta \leq 70$ °C $0.85 \times U_c \text{ min...} U_c \text{ max.}$					
	DC supply	At $\theta \leq 60$ °C $0.85 \times U_c \text{ min...} 1.1 \times U_c \text{ max.}$ At $\theta \leq 70$ °C (AF) $0.85 \times U_c \text{ min...} U_c \text{ max.}$ - (AF..Z) $0.85 \times U_c \text{ min...} 1.1 \times U_c \text{ max.}$					
AC control voltage 50/60 Hz		24...500 V AC					
Rated control circuit voltage U_c	Average pull-in value	(AF) 50 VA - (AF..Z) 16 VA					
Coil consumption	Average holding value	(AF) 2.2 VA / 2 W - (AF..Z) 1.7 VA / 1.5 W					
DC control voltage		12...500 V DC					
Rated control circuit voltage U_c	Average pull-in value	(AF) 50 W - (AF..Z) 12...16 W					
Coil consumption	Average holding value	(AF) 2 W - (AF..Z) 1.7 W					
PLC-output control		(AF..Z) ≥ 500 mA 24 V DC					
Drop-out voltage		≤ 60 % of $U_c \text{ min.}$					
Voltage sag immunity acc. to SEMI F47-0706		(AF..Z) conditions of use on request					
Dips withstand -20 °C $\leq \theta \leq +60$ °C		(AF..Z) 22 ms average for $U_c \geq 24$ V 50/60 Hz or $U_c \geq 20$ V DC					
Operating time							
Between coil energization and:	N.O. contact closing	40...95 ms					
	N.C. contact opening	38...90 ms					
Between coil de-energization and:	N.O. contact opening	11...95 ms					
	N.C. contact closing	13...98 ms					

Mounting characteristics and conditions for use

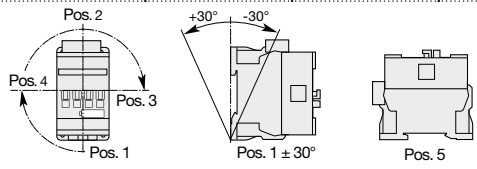
Contactor types	AC / DC operated	AF09	AF12	AF16	AF26	AF30	AF38
Mounting positions							
		Max. N.C. built-in and add-on N.C. auxiliary contacts: see accessory fitting details for a 3-pole contactor AF09 ... AF38					
Mounting distances		The contactors can be assembled side by side					
Fixing							
On rail according to IEC 60715, EN 60715		35 x 7.5 mm or 35 x 15 mm					
By screws (not supplied)		2 x M4 screws placed diagonally					

AF40 ... AF96 3-pole contactors

Technical data

General technical data

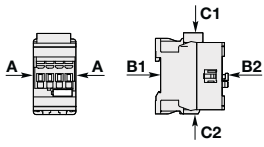
Contactor types	AC / DC operated	AF40	AF52	AF65	AF80	AF96
Rated insulation voltage U_i acc. to IEC 60947-4-1 acc. to UL / CSA		690 V 600 V			1000 V	
Rated impulse withstand voltage U_{imp}		6 kV			8 kV	
Electromagnetic compatibility		Devices complying with IEC 60947-1 / EN 60947-1 - Environment A and B				
Ambient air temperature close to contactor						
Operation	Fitted with thermal overload relay	-25...+60 °C				
	Without thermal overload relay	-40...+70 °C				
Storage		-60...+80 °C				
Climatic withstand		Category B according to IEC 60947-1 Annex Q				
Maximum operating altitude (without derating)		3000 m				
Mechanical durability						
Number of operating cycles		10 millions operating cycles				
Maximum switching frequency		3600 cycles/h				
Shock withstand acc. to IEC 60068-2-27 and EN 60068-2-27 Mounting position 1						
	Shock direction	1/2 sinusoidal shock for 11 ms: no change in contact position, closed or open position				
	A	25 g				
	B1	25 g closed position / 5 g open position				
	B2	15 g				
	C1	25 g				
	C2	25 g				
Vibration withstand acc. to IEC 60068-2-6		5...300 Hz 3 g closed position / 3 g open position				

Magnet system characteristics

Contactor types	AC / DC operated	AF40	AF52	AF65	AF80	AF96
Coil operating limits acc. to IEC 60947-4-1	AC supply	At $\theta \leq 70$ °C $0.85 \times U_c \text{ min} \dots 1.1 \times U_c \text{ max}$.				
	DC supply	At $\theta \leq 70$ °C $0.85 \times U_c \text{ min} \dots 1.1 \times U_c \text{ max}$.				
AC control voltage 50/60 Hz						
Rated control circuit voltage U_c		24...500 V AC				
Coil consumption	Average pull-in value	25 VA			40 VA	
	Average holding value	4 VA / 2 W				
DC control voltage						
Rated control circuit voltage U_c		20...500 V DC				
Coil consumption	Average pull-in value	25 W			40 W	
	Average holding value	2 W				
PLC-output control		-				
Drop-out voltage		≤ 60 % of $U_c \text{ min}$.				
Voltage sag immunity acc. to SEMI F47-0706		conditions of use on request				
Dips withstand -20 °C $\leq \theta \leq$ +60 °C		24 ms average				
Operating time						
Between coil energization and:	N.O. contact closing	42...100 ms				
	N.C. contact opening	38...95 ms				
Between coil de-energization and:	N.O. contact opening	17...100 ms				
	N.C. contact closing	19...105 ms				

Mounting characteristics and conditions for use

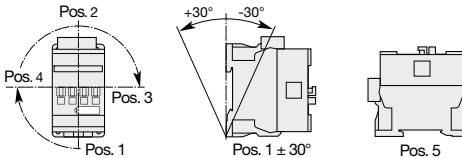
Contactor types	AC / DC operated	AF40	AF52	AF65	AF80	AF96
Mounting positions						
		Max. N.C. built-in and add-on N.C. auxiliary contacts: see accessory fitting details for a 3-pole contactor AF40 ... AF96				
Mounting distances		The contactors can be assembled side by side				
Fixing						
On rail according to IEC 60715, EN 60715		35 x 7.5 mm or 35 x 15 mm			35 x 15 mm	
By screws (not supplied)		2 x M4 or 2 x M6 screws placed diagonally				

AF116 ... AF370 3-pole contactors

Technical data

General technical data

Contactor types	AC / DC operated	AF116	AF140	AF146	AF190	AF205	AF265	AF305	AF370	
Rated insulation voltage Ui acc. to IEC 60947-4-1 acc. to UL / CSA		1000 V	600 V	8 kV						
Rated impulse withstand voltage Uimp.		8 kV								
Electromagnetic compatibility		AF contactors comply with IEC 60947-1 / EN 60947-1 - Environment A								
Ambient air temperature close to contactor										
Operation	Fitted with thermal overload relay	-25 to +55 °C								
	Without thermal overload relay	-40 to +70 °C								
Storage		-40 to +70 °C								
Maximum operating altitude (without derating)		3000 m								
Mechanical durability										
Number of operating cycles		5 million operating cycles								
Maximum switching frequency		300 cycles/h								
Shock withstand acc. to IEC 60068-2-27 and EN 60068-2-27										
Mounting position 1		No change in contact position, closed or open position								
	Shock direction	1/2 sinusoidal shock for 11 ms	1/2 sinusoidal shock for 30 ms							
	A	20 g	20 g							
	B1	15 g closed position / 3 g open position	15 g closed position / 3 g open position							
	B2	15 g closed position / 3 g open position	15 g closed position / 3 g open position							
	C1	20 g	20 g							
	C2	20 g	20 g							
Vibration withstand acc to IEC 60068-2-6		0.7 g closed position / 0.7 g open position 13.2...100 Hz								

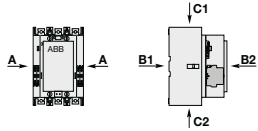

Magnet system characteristics

Contactor types	AC / DC operated	AF116	AF140	AF146	AF190	AF205	AF265	AF305	AF370
Coil operating limits acc. to IEC 60947-4-1	AC supply	At $\theta \leq 70$ °C $0.85 \times U_c \text{ min} \dots 1.1 \times U_c \text{ max}$							
	DC supply	At $\theta \leq 70$ °C $0.80 \times U_c \text{ min} \dots 1.1 \times U_c \text{ max}$							
Rated control circuit voltage Uc		24...500 V AC, 20...500 V DC							
Coil consumption									
AC control voltage 50/60 Hz									
24...60 V AC	Average pull-in value	225 VA			165 VA		475 VA		
	Average holding value	5.5 VA			6 VA		8.5 VA		
48...130 V AC	Average pull-in value	170 VA			175 VA		340 VA		
	Average holding value	4 VA			4 VA		17 VA		
100...250 V AC	Average pull-in value	130 VA			220 VA		385 VA		
	Average holding value	6 VA			7 VA		17.5 VA		
250...500 V AC	Average pull-in value	205 VA			185 VA		420 VA		
	Average holding value	16 VA			16 VA		21 VA		
DC control voltage									
20...60 V DC	Average pull-in value	210 W			205 W		400 W		
	Average holding value	2.5 W			2.5 W		3.5 W		
48...130 V DC	Average pull-in value	130 W			130 W		360 W		
	Average holding value	2.5 W			2.5 W		2.5 W		
100...250 V DC	Average pull-in value	135 W			190 W		410 W		
	Average holding value	3 W			2.5 W		4.5 W		
250...500 V DC	Average pull-in value	205 W			190 W		600 W		
	Average holding value	4 W			4 W		4.7 W		
Drop-out voltage		55 % of Uc min							
Voltage sag immunity acc. to SEMI F47		Conditions of use on request							
Dips withstand		≥ 20 ms							
Operating time									
Coil supply between A1 - A2									
Between coil energization and:	N.O. contact closing	20...55 ms			25...60 ms		30...60 ms		
Between coil de-energization and:	N.O. contact opening	40...70 ms			45...80 ms		45...80 ms		

Mounting characteristics and conditions for use

Contactor types	AC / DC operated	AF116	AF140	AF146	AF190	AF205	AF265	AF305	AF370
Mounting positions									
		Max. add-on N.O. or N.C. auxiliary contacts: see accessory fitting details for 3-pole contactor AF116 ... AF370							
Mounting distances		The contactors can be assembled side by side							
Fixing									
On rail acc. to IEC 60715, EN 60715		-							
By screws (not supplied)		4 x M5							

AF400 ... AF2650 3-pole contactors

Technical data

General technical data

Contactor types	AC / DC operated	AF400	AF460	AF580	AF750	AF1250	AF1350	AF1650	AF2050	AF2650
Rated insulation voltage U_i acc. to IEC 60947-4-1 acc. to UL / CSA		1000 V					1000 V			
Rated impulse withstand voltage U_{imp}		600 V								
Electromagnetic compatibility		AF contactors complying with IEC 60947-1 / EN 60947-1 - Environment A								
Ambient air temperature close to contactor										
Operation	Fitted with electronic overload relay	-25 to +70 °C								
	Without electronic overload relay	-40 to +70 °C								
Storage		-40 to +70 °C								
Maximum operating altitude (without derating)		3000 m								
Mechanical durability										
Number of operating cycles		3 millions operating cycles			0.5 million operating cycles			0.3 million operating cycles		
Max. switching frequency		300 cycles/h			60 cycles/h					
Shock withstand acc. to IEC 60068-2-27 and EN 60068-2-27 Mounting position 1										
	Shock direction	1/2 sinusoidal shock for 30 ms: no change in contact position, closed or open position								
	A	5 g			-			-		
	B1	5 g			-			-		
	B2	5 g			-			-		
	C1	5 g			-			-		
	C2	5 g			-			-		

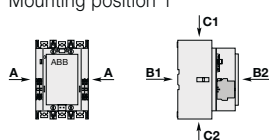

Magnet system characteristics

Contactor types	AC / DC operated	AF400	AF460	AF580	AF750	AF1250	AF1350	AF1650	AF2050	AF2650	
Coil operating limits	AC supply	At $\theta \leq 70$ °C 0.85 x U_c min ... 1.1 x U_c max									
	DC supply	At $\theta \leq 70$ °C 0.80 x U_c min ... 1.1 x U_c max									
Rated control circuit voltage U_c		48...500 V AC, 24...500 V DC					100...250 V AC or DC				
Coil consumption											
AC control voltage 50/60 Hz											
48...130 V AC	Average pull-in value	1215 VA			1100 VA			-			
	Average holding value	12 VA			12 VA			-			
100...250 V AC	Average pull-in value	955 VA			880 VA			2450 VA			
	Average holding value	12 VA			12 VA			48 VA			
250 ... 500 V AC	Average pull-in value	950 VA			985 VA			-			
	Average holding value	12 VA			12 VA			-			
DC control voltage											
24...60 V DC	Average pull-in value	900 VA			785 VA			-			
	Average holding value	5 VA			5.5 VA			-			
48...130 V DC	Average pull-in value	1150 VA			1020 VA			-			
	Average holding value	5 VA			5 VA			-			
100...250 V DC	Average pull-in value	895 VA			880 VA			2290 VA			
	Average holding value	5 VA			5 VA			20.5 VA			
250 ... 500 V DC	Average pull-in value	885 VA			910 VA			-			
	Average holding value	7.5 VA			7.5 VA			-			
Drop-out voltage		55 % of U_c min.									
Voltage sag immunity acc. to SEMI F47		Conditions of use on request									
Dips withstand		≥ 20 ms									
Operating time											
Coil supply between A1 - A2											
Between coil energization and:	Main contact closing	50...120 ms			50...80 ms			50...80 ms			
Between coil de-energization and:	Main contact opening	33...70 ms			35...55 ms			35...55 ms			
Control input for PLC's											
Between coil energization and:	Main contact closing	40...60 ms			40...90 ms			40...65 ms			
Between coil de-energization and:	Main contact opening	10...30 ms			10...30 ms			10...30 ms			















Mounting characteristics and conditions for use

Contactor types	AC / DC operated	AF400	AF460	AF580	AF750	AF1250	AF1350	AF1650	AF2050	AF2650
Mounting positions										
		Max. add-on N.O. or N.C. auxiliary contacts: see accessory fitting details for 3-pole contactor AF400 ... AF2650								
Mounting distances		The contactors can be assembled side by side								
Fixing										
On rail according to IEC 60715, EN 60715		-								
By screws (not supplied)		4 x M5			4 x M6			4 x M8		

AF09 ... AF38 3-pole contactors

Technical data











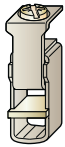
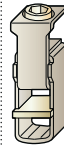



Connecting characteristics

Contactor types	AC / DC operated	AF09	AF12	AF16	AF26	AF30	AF38
Main terminals		 Screw terminals with cable clamp					
Connection capacity (min. ... max.)							
Main conductors (poles)							
 Rigid	Solid ($\leq 4 \text{ mm}^2$)	} 1 x	1...6 mm ²			2.5...10 mm ²	
 Stranded ($\geq 6 \text{ mm}^2$)			2 x 1...6 mm ²			2.5...10 mm ²	
 Flexible with non insulated ferrule		1 x	0.75...6 mm ²			1.5...10 mm ²	
 Flexible with insulated ferrule		2 x	0.75...6 mm ²			1.5...10 mm ²	
 Flexible with insulated ferrule		1 x	0.75...4 mm ²			1.5...10 mm ²	
 Flexible with insulated ferrule		2 x	0.75...2.5 mm ²			1.5...4 mm ²	
 Bars or lugs		L <	9.6 mm			12.5 mm	
Connection capacity acc. to UL/CSA		1 or 2 x	AWG 16...10			AWG 14...8	
Stripping length			10 mm			14 mm	
Tightening torque			1.5 Nm / 13 lb.in			2.5 Nm / 22 lb.in	
Auxiliary conductors							
(built-in auxiliary terminals + coil terminals)							
 Rigid solid		1 x	1...2.5 mm ²				
 Rigid solid		2 x	1...2.5 mm ²				
 Flexible with non insulated ferrule		1 x	0.75...2.5 mm ²				
 Flexible with non insulated ferrule		2 x	0.75...2.5 mm ²				
 Flexible with insulated ferrule		1 x	0.75...2.5 mm ²				
 Flexible with insulated ferrule		2 x	0.75...1.5 mm ²				
 Lugs		L <	8 mm				
Connection capacity acc. to UL/CSA		1 or 2 x	AWG 18...14				
Stripping length			10 mm				
Tightening torque							
Coil terminals			1.2 Nm / 11 lb.in				
Built-in auxiliary terminals			1.2 Nm / 11 lb.in				
Degree of protection							
acc. to IEC 60947-1 / EN 60947-1 and IEC 60529 / EN 60529							
Main terminals			IP20				
Coil terminals			IP20				
Built-in auxiliary terminals			IP20				
Screw terminals							
Main terminals			Delivered in open position, screws of unused terminals must be tightened				
			M3.5			M4	
		Screwdriver type	Flat Ø 5.5 / Pozidriv 2			Flat Ø 6.5 / Pozidriv 2	
Coil terminals			M3.5				
		Screwdriver type	Flat Ø 5.5 / Pozidriv 2				
Built-in auxiliary terminals			M3.5				
		Screwdriver type	Flat Ø 5.5 / Pozidriv 2				

AF40 ... AF96 3-pole contactors

Technical data

Connecting characteristics

Contactor types	AC / DC operated	AF40	AF52	AF65	AF80	AF96
Main terminals						
		Screw terminals with double connector 2 x (9.3 width x 7.9/10.3 depth)			Screw terminals with double connector 2 x (12.4 width x 9.3/11.1 depth)	
Connection capacity (min. ... max.)						
Main conductors (poles)						
	Rigid	Solid ($\leq 4 \text{ mm}^2$)	} 1 x	6...35 mm ²		6...70 mm ²
		Stranded ($\geq 6 \text{ mm}^2$)		2 x	6...35 mm ²	
	Flexible with non insulated ferrule		1 x	4...35 mm ²		6...50 mm ²
			2 x	4...35 mm ²		6...50 mm ²
	Flexible with insulated ferrule		1 x	4...35 mm ²		6...50 mm ²
			2 x	4...35 mm ²		6...50 mm ²
	Bars or lugs		L <	9.2 mm		12.2 mm
Connection capacity acc. to UL/CSA			1 or 2 x	AWG 10...2		AWG 6...1
Stripping length				16 mm		17 mm
Tightening torque				4 Nm / 35 lb.in		6 Nm / 53 lb.in
Auxiliary conductors (built-in auxiliary terminals + coil terminals)						
	Rigid solid		1 x	1...2.5 mm ²		
			2 x	1...2.5 mm ²		
	Flexible with non insulated ferrule		1 x	0.75...2.5 mm ²		
			2 x	0.75...2.5 mm ²		
	Flexible with insulated ferrule		1 x	0.75...2.5 mm ²		
			2 x	0.75...1.5 mm ²		
	Lugs		L <	8 mm		
Connection capacity acc. to UL/CSA			1 or 2 x	AWG 18...14		
Stripping length				10 mm		
Tightening torque				1.2 Nm / 11 lb.in		
Coil terminals				1.2 Nm / 11 lb.in		
Built-in auxiliary terminals				1.2 Nm / 11 lb.in		
Degree of protection acc. to IEC 60947-1 / EN 60947-1 and IEC 60529 / EN 60529						
Main terminals				IP10		
Coil terminals				IP20		
Built-in auxiliary terminals				IP20		
Screw terminals						
Main terminals				Delivered in open position, screws of unused terminals must be tightened		
				M6	M8	
		Screwdriver type		Flat Ø 6.5 / Pozidriv 2		Hexagon socket (s = 4 mm)
Coil terminals				M3.5		
		Screwdriver type		Flat Ø 5.5 / Pozidriv 2		
Built-in auxiliary terminals				M3.5		
		Screwdriver type		Flat Ø 5.5 / Pozidriv 2		

AF116 ... AF370 3-pole contactors

Technical data

Connecting characteristics

Contactor types	AC / DC operated	AF116	AF140	AF146	AF190	AF205	AF265	AF305	AF370
Main terminals									
Flat type									
Connection capacity (min. ... max.)									
Main conductors (poles)									
	Cu cable - Stranded	1 x	10...95 mm ²		6...150 mm ²		16...300 mm ²		
	Clamp type		LD... included (1)		1SDA066917R1		1SDA055016R1		
	Tightening torque		8 Nm		14 Nm		25 Nm		
	Cu cable - Stranded	2 x	10...95 mm ²		50...120 mm ²		70...185 mm ²		
	Clamp type		LD... included (1)		1SFN074709R1000, LZ185-2C/120		1SCA022194R0890, OZXB4		
	Tightening torque		8 Nm		16 Nm		22 Nm		
	Al cable - Stranded	1 x	-		95...185 mm ²		185...240 mm ²		
	Clamp type		-		1SDA054988R1		1SDA055020R1		
	Tightening torque		-		31 Nm		43 Nm		
	Cu cable - Flexible	1 x	10...70 mm ²		6...120 mm ²		16...240 mm ²		
	Clamp type		LD... included (1)		1SDA066917R1		1SDA055016R1		
	Tightening torque		8 Nm		14 Nm		25 Nm		
	Cu cable - Flexible	2 x	10...70 mm ²		50...95 mm ²		70...185 mm ²		
	Clamp type		LD... included (1)		1SFN074709R1000, LZ185-2C/120		1SCA022194R0890, OZXB4		
	Tightening torque		8 Nm		16 Nm		22 Nm		
	Lugs	L ≤	22 mm (.866 in)		24 mm (.945 in)		32 mm (1.260 in)		
		Ø >	6 mm (.236 in)		8 mm (.315 in)		10 mm (.394 in)		
	Socket type		LL... included		LL... included		LL... included		
	Tightening torque		9 Nm / 80 lb.in		18 Nm / 160 lb.in		28 Nm / 248 lb.in		
	Connection capacity acc. to UL / CSA	1 x	AWG 6...3/0		6...300 MCM		4...400 MCM		
	Clamp type		LD... included (1)		ATK185 (2)		ATK300 (2)		
	Tightening torque		8 Nm / 71 lb.in		34 Nm / 301 lb.in		42 Nm / 372 lb.in		
	Connection capacity acc. to UL / CSA	2 x	AWG 6...3/0		-		4...500 MCM		
	Clamp type		LD... included (1)		-		ATK300/2 (2)		
	Tightening torque		8 Nm / 71 lb.in		-		42 Nm / 372 lb.in		
Auxiliary conductors									
(coil terminals)									
	Solid / stranded	1 x	1...4 mm ²						
		2 x	1...4 mm ²						
	Flexible	1 x	0.75...2.5 mm ²						
		2 x	0.75...2.5 mm ²						
	Flexible with non insulated ferrule	1 x	0.75...2.5 mm ²						
		2 x	0.75...2.5 mm ²						
	Flexible with insulated ferrule	1 x	0.75...2.5 mm ²						
		2 x	0.75...2.5 mm ²						
	Lugs	L <	8 mm						
		l >	3.5 mm						
	Connection capacity acc. to UL / CSA	1 or 2 x	AWG 18...14						
	Stripping length		9 mm						
	Tightening torque		1.00 Nm / 9 lb.in						
Degree of protection									
acc. to IEC 60947-1 / EN 60947-1 and IEC 60529 / EN 60529									
	Main terminals		IP00						
	Coil terminals		IP20						
Screw terminals									
	Main terminals		M6		M8		M10		
		Screwdriver type	Screws and bolts						
	Coil terminals (delivered in open position)		M3.5						
		Screwdriver type	Flat Ø 5.5 mm / Pozidriv 2						









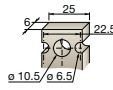
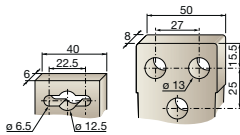
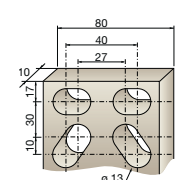
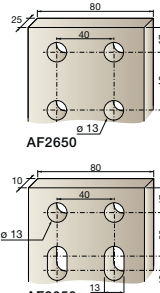

(1) LD... not included for AF116 ... AF146-30...B.

(2) Available in North America only.

AF400 ... AF2650 3-pole contactors

Technical data

Connecting characteristics

Contactor types	AC / DC operated	AF400	AF460	AF580	AF750	AF1250	AF1350	AF1650	AF2050	AF2650
Main terminals										
Flat type										
										
Connection capacity (min. ... max.)										
Main conductors (poles)										
	Cu cable - Stranded	2 x	240 mm ²							
	Clamp type		1SDA013922R1							
	Tightening torque		35 Nm							
	Cu cable - Stranded	3 x	–	185 mm ²						
	Clamp type		–	1SDA013956R1						
	Tightening torque		35 Nm	45 Nm						
	Al cable - Stranded	2 x	240 mm ²							
	Clamp type		1SDA013922R1							
	Tightening torque		35 Nm							
		3 x	–	185 mm ²						
	Clamp type		–	1SDA013956R1						
	Tightening torque		35 Nm	45 Nm						
	Lugs	L ≤	47 mm	50 mm				100 mm		
		Ø >	10 mm	12 mm						
	Tightening torque		35 Nm / 310 lb.in	45 Nm / 398 lb.in						
Connection capacity acc. to UL / CSA		2 x	250-500 MCM alt. 2/0 AWG-400 MCM	–		2// 3 x 0.25 in	4/0 AWG - 500 MCM	4//4 x 0.25 in		
	Clamp type		K6TH alt. ATK580	–		bars, use LW1250	K7TK ATK1350/4	K7TK	bars	
	Tightening torque		275 lb.in	–			375 lb.in			
Connection capacity acc. to UL / CSA		3 x	2/0 AWG-400 MCM	2/0 AWG-500 MCM			1/0-750 MCM			
	Clamp type		K6TJ	ATK750/3			K8TL, K8TM, ATK1650/4	K8TL, K8TM, ATK1650/4, ATK1650/6		
	Tightening torque		275 lb.in	375 lb.in			500 lb.in			
Auxiliary conductors (coil terminals)										
	Solid / stranded	1 x	1...4 mm ²							
		2 x	1...4 mm ²							
	Flexible	1 x	0.75...2.5 mm ²							
		2 x	0.75...2.5 mm ²							
	Flexible with non insulated ferrule	1 x	0.75...2.5 mm ²							
		2 x	0.75...2.5 mm ²							
	Flexible with insulated ferrule	1 x	0.75...2.5 mm ²							
		2 x	0.75...2.5 mm ²							
	Lugs	L ≤	8 mm							
		l >	3.7 mm							
Connection capacity acc. to UL / CSA		1 or 2 x	AWG 18...14							
	Tightening torque	Recommended	1.00 Nm / 9 lb.in							
		Max.	1.20 Nm							
Degree of protection										
acc. to IEC 60947-1 / EN 60947-1 and IEC 60529 / EN 60529										
	Main terminals		IP00							
	Coil terminals		IP20							
Screw terminals										
	Main terminals		M10	M12						
	Coil terminals (delivered in open position)		Screws and bolts							
			M3.5							
	Screwdriver type		Flat Ø 5.5 mm / Pozidriv 2							

AF09 ... AF96 3-pole contactors

Technical data

Built-in auxiliary contacts according to IEC

Contactor types	AC / DC operated	AF09	AF12	AF16	AF26	AF30	AF38	AF40	AF52	AF65	AF80	AF96
Rated operational voltage U _e max.		690 V										
Rated frequency (without derating)		50 / 60 Hz										
Conventional free air thermal current I _{th} - θ ≤ 40 °C		16 A										
le / Rated operational current AC-15		16 A										
acc. to IEC 60947-5-1		16 A										
	24-127 V 50/60 Hz	6 A										
	220-240 V 50/60 Hz	4 A										
	400-440 V 50/60 Hz	3 A										
	500 V 50/60 Hz	2 A										
	690 V 50/60 Hz	2 A										
Making capacity AC-15		10 x I _e AC-15 acc. to IEC 60947-5-1										
Breaking capacity AC-15		10 x I _e AC-15 acc. to IEC 60947-5-1										
le / Rated operational current DC-13		16 A										
acc. to IEC 60947-5-1		16 A										
	24 V DC	6 A / 144 W										
	48 V DC	2.8 A / 134 W										
	72 V DC	1 A / 72 W										
	110 V DC	0.55 A / 60 W										
	125 V DC	0.55 A / 69 W										
	220 V DC	0.27 A / 60 W										
	250 V DC	0.27 A / 68 W										
	400 V DC	0.15 A / 60 W										
	500 V DC	0.13 A / 65 W										
	600 V DC	0.1 A / 60 W										
Short-circuit protection device gG type fuse		10 A										
Rated short-time withstand current I _{cw}	for 1.0 s	100 A										
	for 0.1 s	140 A										
Minimum switching capacity		12 V / 3 mA										
with failure rate acc. to IEC 60947-5-4		10 ⁻⁷										
Non-overlapping time between N.O. and N.C. contacts		≥ 2 ms										
Power dissipation per pole at 6 A		0.1 W										
Max. electrical switching frequency	AC-15	1200 cycles/h										
	DC-13	900 cycles/h										
Mechanically linked contacts		Built-in N.O. or N.C. auxiliary contacts and additional N.O. or N.C. auxiliary contacts (CA4, CAL4, CAT4 aux. contact blocks) are mechanically linked contacts.										
acc. to annex L of IEC 60947-5-1												
Mirror contacts		Built-in N.C. auxiliary contacts or additional N.C. auxiliary contacts (CA4, CAL4, CAT4 aux. contact blocks) are mirror contacts.										
acc. to annex F of IEC 60947-4-1												

Built-in auxiliary contacts according to UL / CSA

Contactor types	AC / DC operated	AF09	AF12	AF16	AF26	AF30	AF38	AF40	AF52	AF65	AF80	AF96
Max. operational voltage		600 V AC, 600 V DC										
Pilot duty		A600, Q600										
AC thermal rated current		10 A										
AC maximum volt-ampere making		7200 VA										
AC maximum volt-ampere breaking		720 VA										
DC thermal rated current		2.5 A										
DC maximum volt-ampere making-breaking		69 VA										

3-pole contactors

Electrical durability and utilization categories

General

Utilization categories determine the current making and breaking conditions relating to the characteristics of the loads to be controlled by the contactors. International standard IEC 60947-4-1 and European standard EN 60947-4-1 are the standards to be referred to.

If I_c is the current to be broken by the contactor and I_e the rated operational current normally drawn by the load, then:

- Categories AC-1 and AC-3: $I_c = I_e$
- Category AC-2: $I_c = 2.5 \times I_e$
- Category AC-4: $I_c = 6 \times I_e$

Generally speaking $I_c = m \times I_e$ where m is a multiple of the load operational current.

On next pages, the curves corresponding to categories AC-1, AC-3 and AC-4 represent the electrical durability variation of standard contactors in relation to the breaking current I_c .

Electrical durability is expressed in millions of operating cycles.

Curve utilization mode

Electrical durability forecast and contactor selection for categories AC-1, AC-2, AC-3 or AC-4

- Note the characteristics of the load to be controlled:
 - Operational voltage U_e
 - Current normally drawn I_e ($U_e / I_e / kW$ relation for motors, see "Motor rated operational powers and currents").
 - Utilization category AC-1, AC-2, AC-3 or AC-4
 - Breaking current $I_c = I_e$ for AC-1 and for AC-3 ; $I_c = 2.5 \times I_e$ for AC-2 ; $I_c = 6 \times I_e$ for AC-4
- Define the number of operating cycles N required.
- On the diagram corresponding to the operational category, select the contactor with the curve immediately above the intersection point ($I_c ; N$).

Electrical durability forecast and contactor selection for mixed duty motor control: AC-3 ($I_c = I_e$) type switching off while "motor running" and, occasionally, AC-4 ($I_c = 6 \times I_e$) type switching off while "motor accelerating"

- Note the characteristics of the motor to be controlled:
 - Operational voltage U_e
 - Current normally drawn while "motor running" I_e ($U_e / I_e / kW$ relation for motors, see "Motor rated operational powers and currents")
 - Breaking current for AC-3 $I_c = I_e$
 - Breaking current for AC-4 while "motor accelerating" $I_c = 6 \times I_e$
 - Percentage of AC-4 operating cycles K (on the basis of the total number of operating cycles)
- Define the total number of operating cycles N required.
- Note the smallest contactor rating compatible for AC-3 (U_e / I_e) on Main pole utilization characteristic table (see "Technical data").
- For the selected contactor make a note of the following in relation to the voltage using diagram AC-3 in next pages:
 - The number of operating cycles A for $I_c = I_e$ (AC-3)
 - The number of operating cycles B for $I_c = 6 \times I_e$ (AC-4)
- Calculate the estimated number of cycles N' (N' is always below A)

$$N' = \frac{A}{1 + 0.01 K (A/B - 1)}$$

- If N' is too low in relation to the target N , calculate the estimated number of cycles for a higher contactor rating.

Case of uninterrupted duty

For uninterrupted duty, some verifications of preventing maintenance are necessary to check the functionality of the concerned product (consult us).

The combined effect of environmental conditions and the proper temperature of the product may require some disposals. As a matter of fact, for this duty, the use duration prevails over the number of operating cycles.

3-pole contactors

Electrical durability

Electrical durability for AC-1 utilization category - $U_e \leq 690\text{ V}$

Switching non-inductive or slightly inductive loads. The breaking current I_c for AC-1 is equal to the rated operational current of the load.

Ambient temperature and maximum electrical switching frequency: see "Technical data".

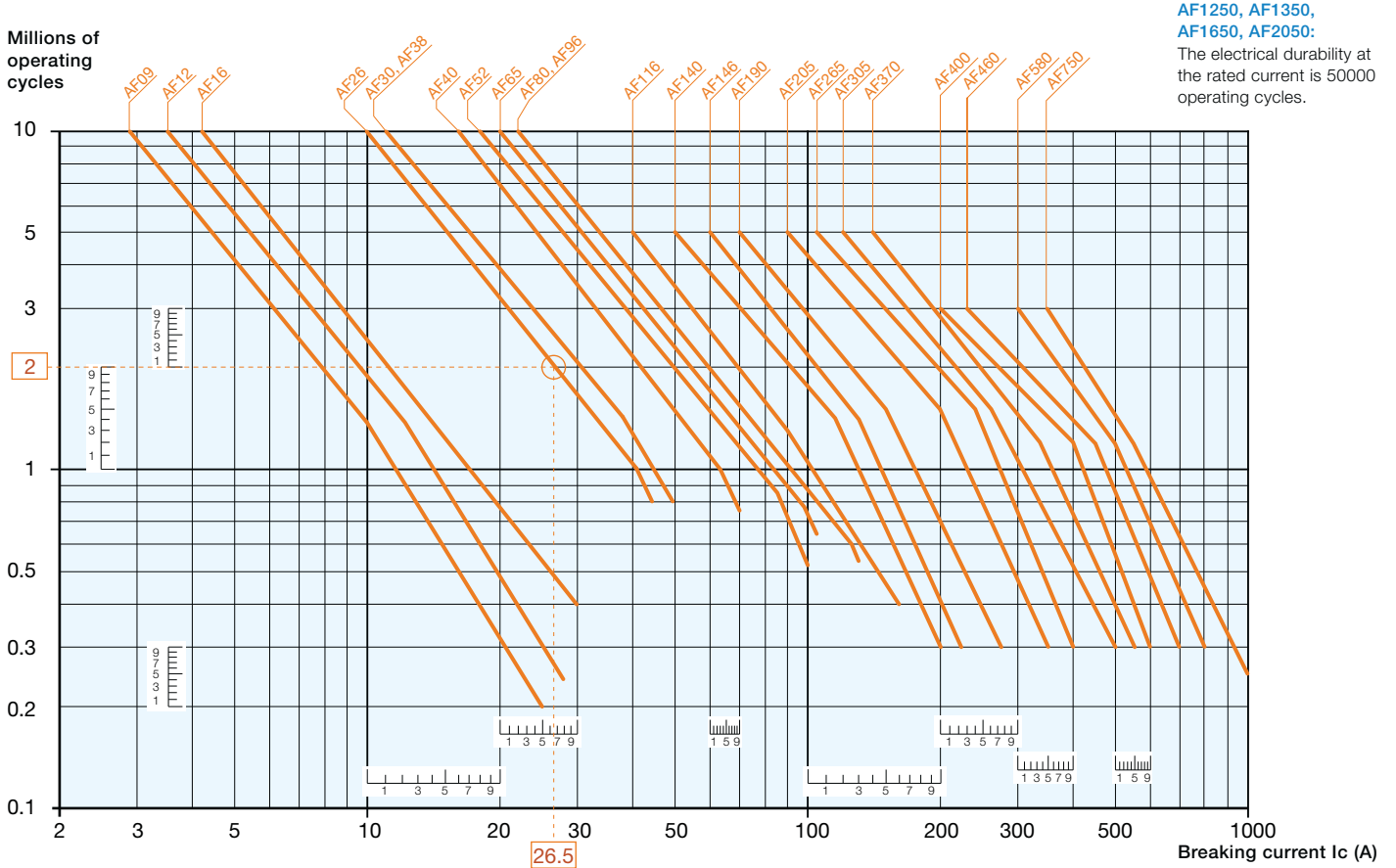

AF1250, AF1350, AF1650, AF2050:
The electrical durability at the rated current is 50000 operating cycles.

Example:

$I_c / AC-1 = 26.5\text{ A}$ – Electrical durability required = 2 millions operating cycles.

Using the AC-1 curves above select the AF26 contactor at intersection "○" (26.5 A / 2 millions operating cycles).

3-pole contactors

Electrical durability

Electrical durability for AC-3 utilization category - $U_e \leq 440$ V.

Switching cage motors: starting and switching off running motors. The breaking current I_c for AC-3 is equal to the rated operational current I_e (I_e = motor full load current).

Ambient temperature and maximum electrical switching frequency: see "Technical data".

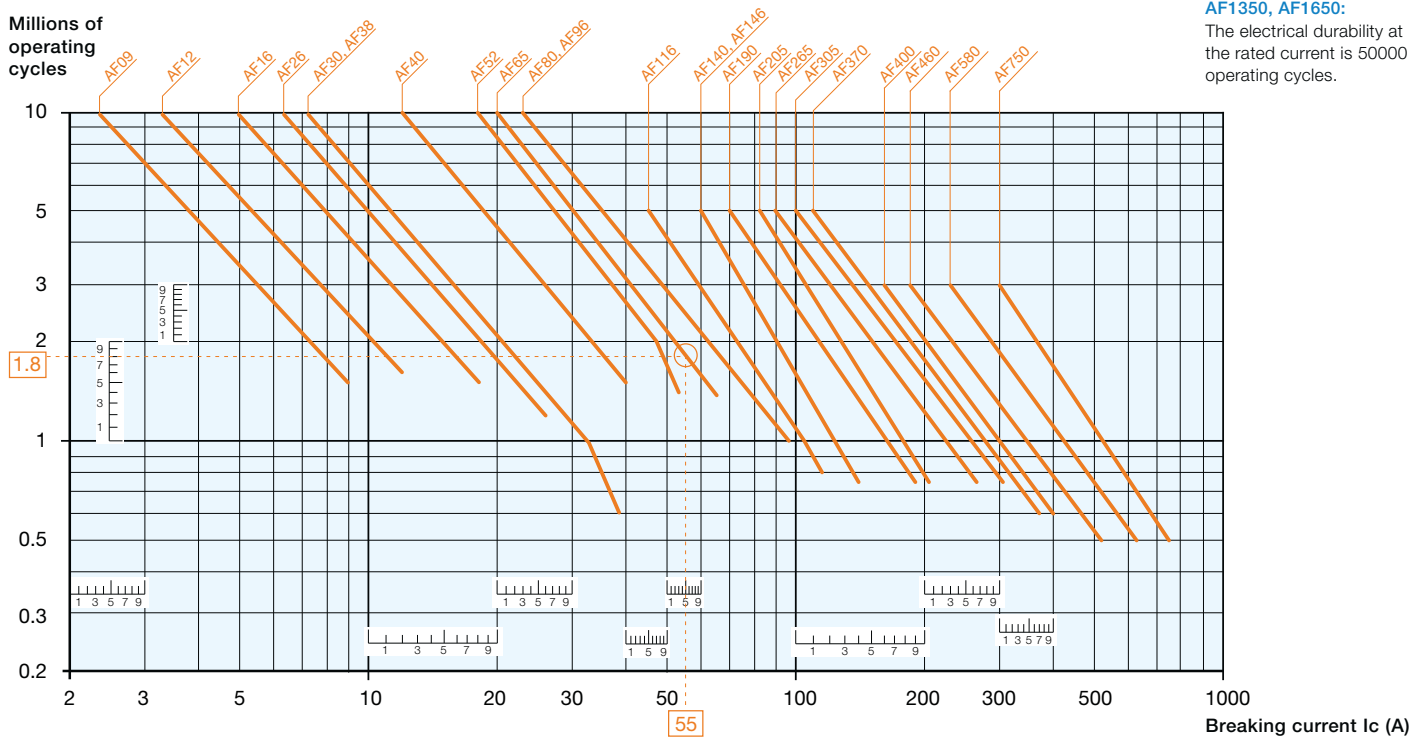

Example:

Motor power 30 kW for AC-3 - $U_e = 400$ V and $I_e = 55$ A utilization – Electrical durability required = 1.8 million operating cycles. For AC-3: $I_c = I_e$. Select the AF65 contactor at intersection "○" (55 A / 1.8 million operating cycles) on the curves (AC-3 - $U_e \leq 440$ V).

3-pole contactors

Electrical durability

Electrical durability for AC-3 utilization category - $440\text{ V} < U_e \leq 690\text{ V}$.

Switching cage motors: starting and switching off running motors. The breaking current I_c for AC-3 is equal to the rated operational current I_e (I_e = motor full load current).

Ambient temperature and maximum electrical switching frequency: see "Technical data".

Millions of operating cycles

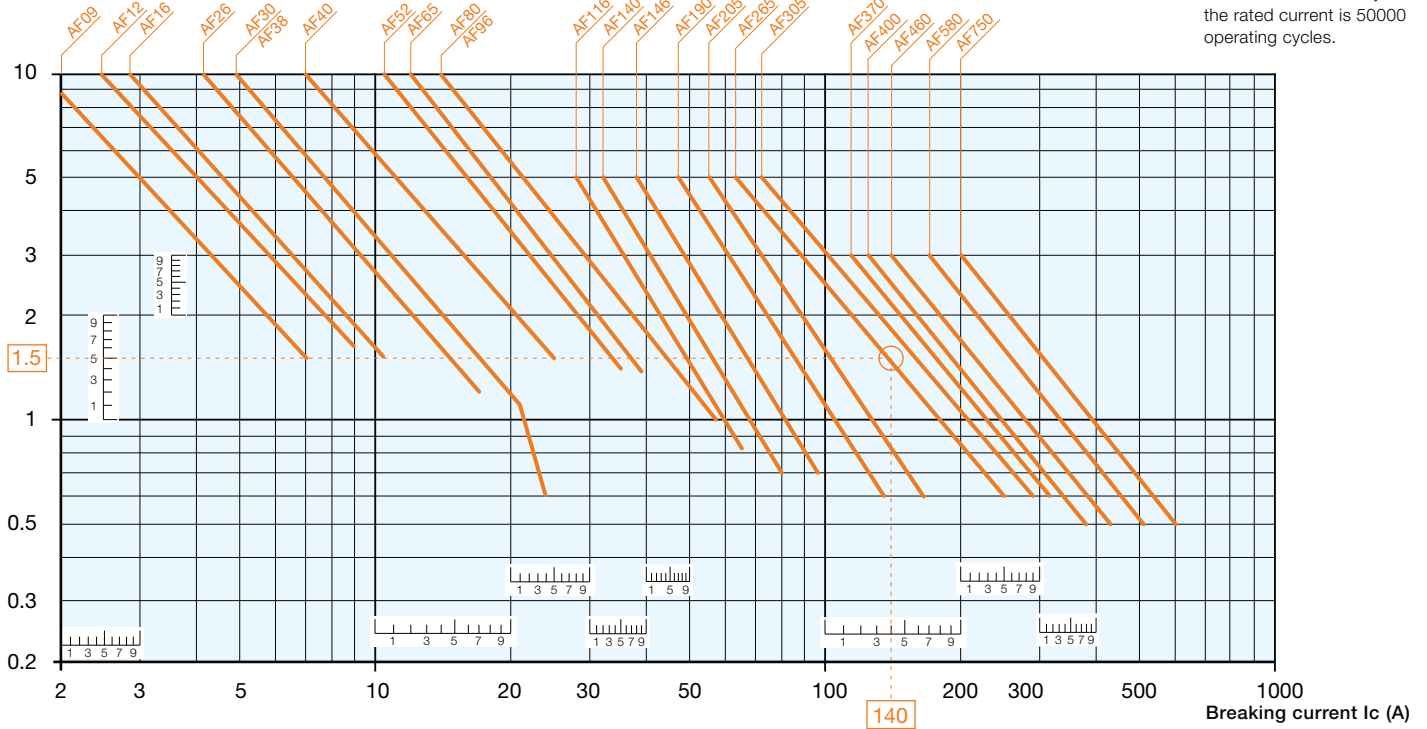

AF1350, AF1650:
The electrical durability at the rated current is 50000 operating cycles.

Example:

Motor power 132 kW for AC-3 - $U_e = 660\text{ V}$ and $I_e = 140\text{ A}$ utilization – Electrical durability required = 1.5 million operating cycles. For AC-3: $I_c = I_e$. Select the AF265 contactor at intersection "O" (140 A / 1.5 million operating cycles) on the curves (AC-3 - $440\text{ V} < U_e \leq 690\text{ V}$).

3-pole contactors

Electrical durability

Electrical durability for AC-2 or AC-4 utilization category - $U_e \leq 440\text{ V}$
 Ambient temperature $\leq 60\text{ }^\circ\text{C}$ for AF09 ... AF370, $\leq 55\text{ }^\circ\text{C}$ for AF400 ... AF1650

Switching cage motors: starting, reverse operation and step-by-step operation. The breaking current I_c is equal to $2.5 \times I_e$ for AC-2 and $6 \times I_e$ for AC-4, keeping in mind that I_e is the motor rated operational current (I_e = motor full-load current).
 Maximum electrical switching frequency: see "Technical data".

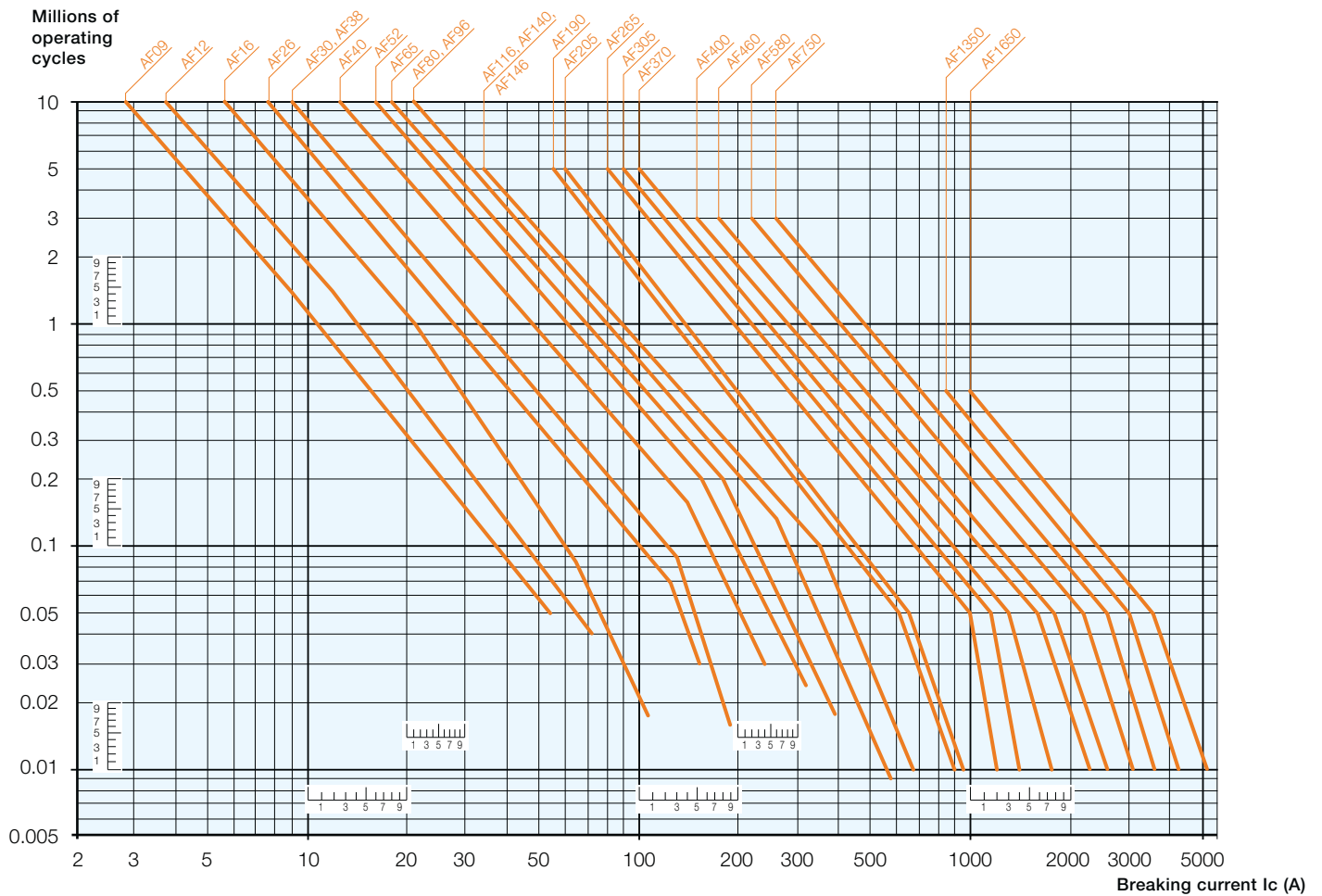

3-pole contactors

Electrical durability

Electrical durability for AC-2 or AC-4 utilization category - $440\text{ V} < U_e \leq 690\text{ V}$

Ambient temperature $\leq 60\text{ }^\circ\text{C}$ for AF09 ... AF370, $\leq 55\text{ }^\circ\text{C}$ for AF400 ... AF750

Switching cage motors: starting, reverse operation and step-by-step operation. The breaking current I_c is equal to $2.5 \times I_e$ for AC-2 and $6 \times I_e$ for AC-4, keeping in mind that I_e is the motor rated operational current (I_e = motor full load current). Maximum electrical switching frequency: see "Technical data".

Millions of operating cycles

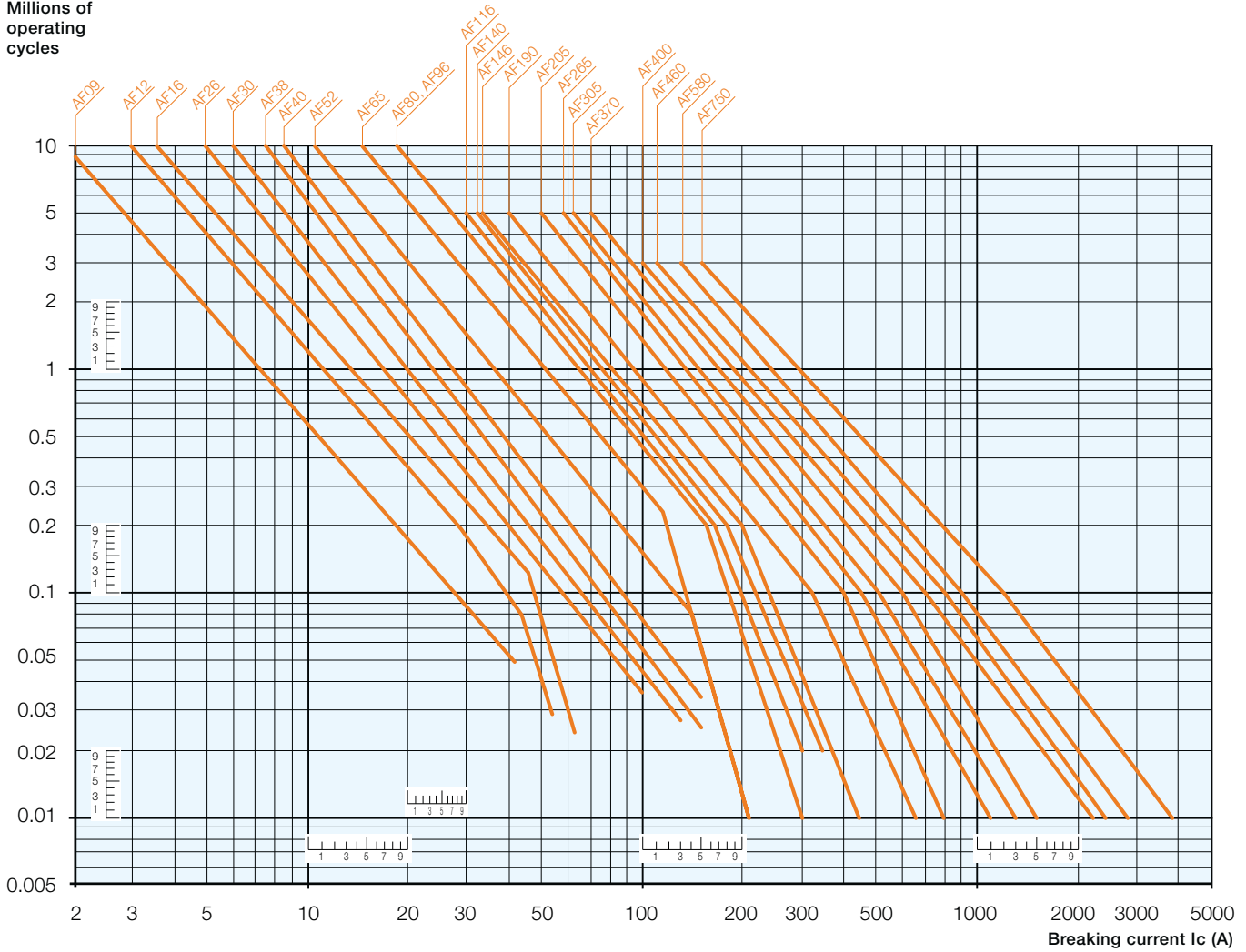

AF09 ... AF96 3-pole contactors

Terminal marking and positioning

AF09 ... AF96 contactors - AC / DC operated

Standard devices without addition of auxiliary contacts

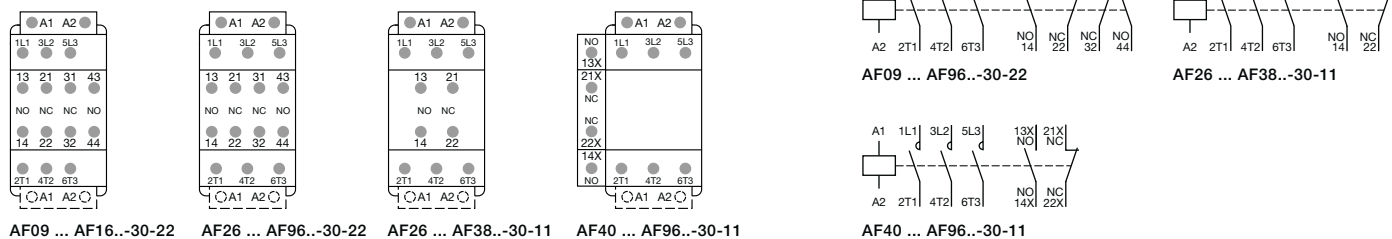
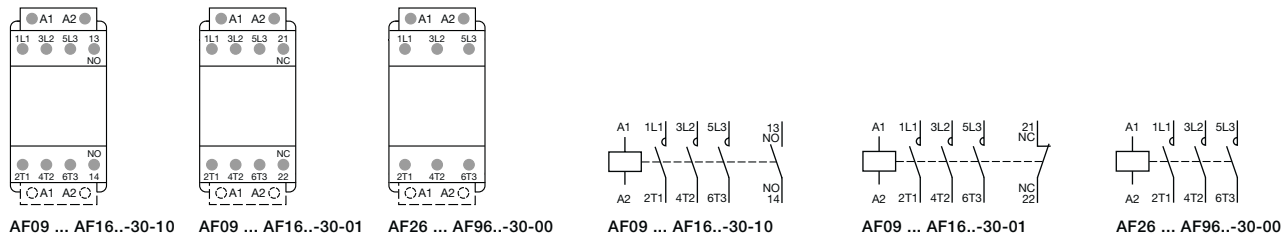

Other possible contact combinations with auxiliary contacts added by the user

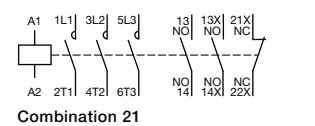
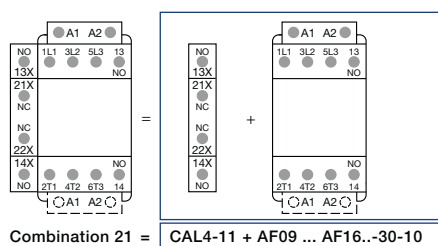
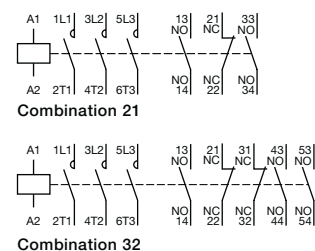
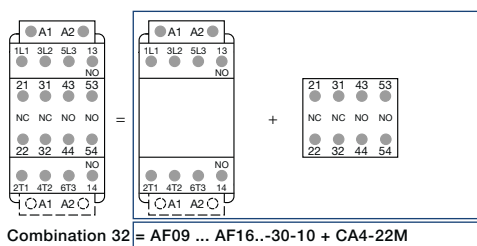
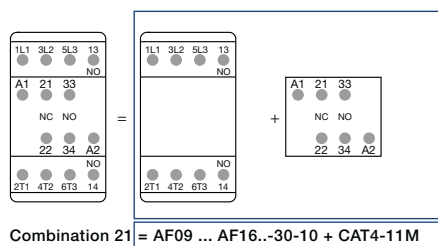
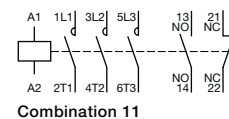
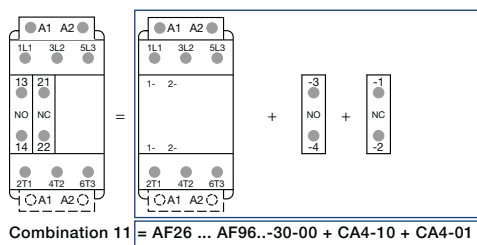
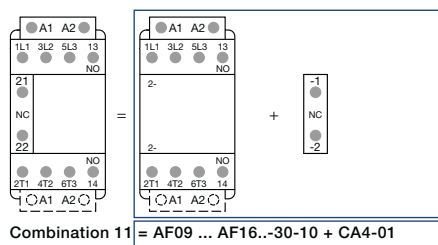

Note: Only AF.Z contactor with DC control voltage 12...20 V DC need to respect the connection polarities indicated close to the coil terminals: A1+ for the positive pole and A2- for the negative pole

AF116 ... AF370 3-pole contactors

Terminal marking and positioning

AF116 ... AF370 contactors - AC / DC operated

Standard devices without addition of auxiliary contacts

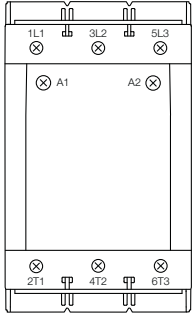

AF116 ... AF370-30-00

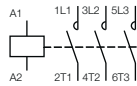

AF116 ... AF370-30-00

5

Standard devices with factory mounted auxiliary contacts

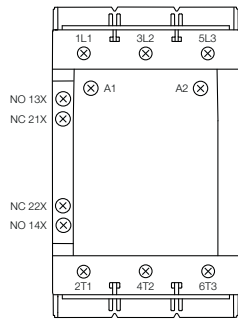

AF116 ... AF370-30-11

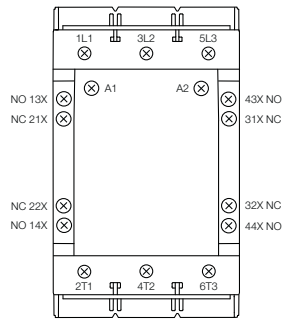

AF116 ... AF370-30-22

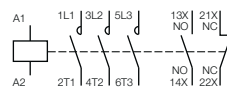

AF116 ... AF370-30-11

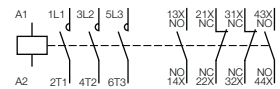

AF116 ... AF370-30-22

AF400 ... AF2650 3-pole contactors

Terminal marking and positioning

AF400 ... AF1250 contactors - AC / DC operated

Standard devices with factory mounted auxiliary contacts

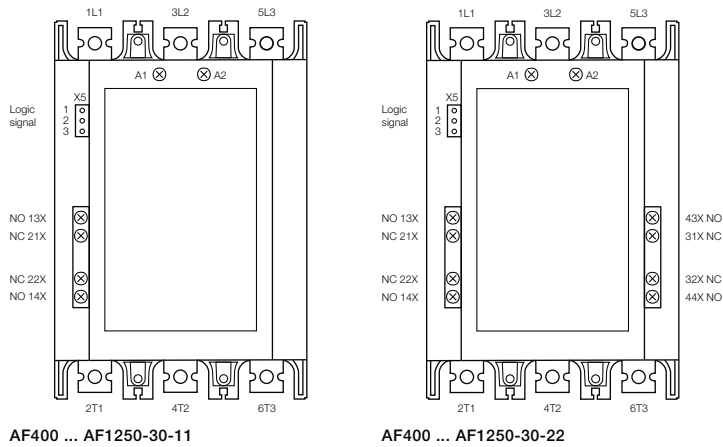

Control with logic signal

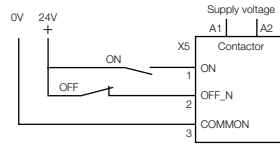

AF400 ... AF1250-30-11, AF400 ... AF1250-30-22

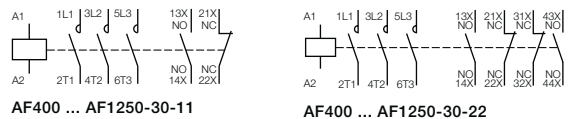

AF1350 ... AF2650 contactors - AC / DC operated

Standard devices with factory mounted auxiliary contacts

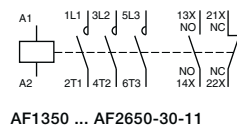
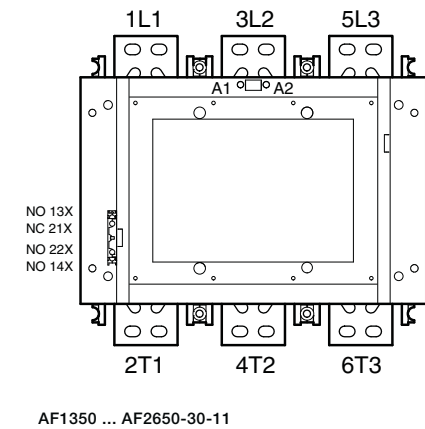

AF1350 ... AF2650-30-11

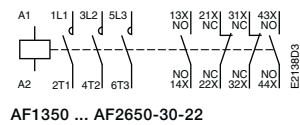

AF1350 ... AF2650-30-22

Wiring diagrams

when used with transistor output

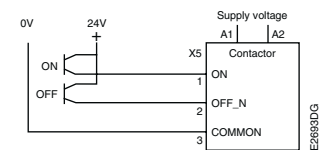

AF1350, AF1650

when used with transistor output

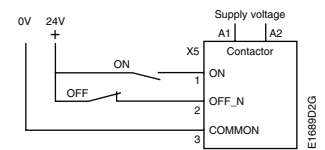

AF09, AF12, AF16 3-pole contactors

Main dimensions mm, inches

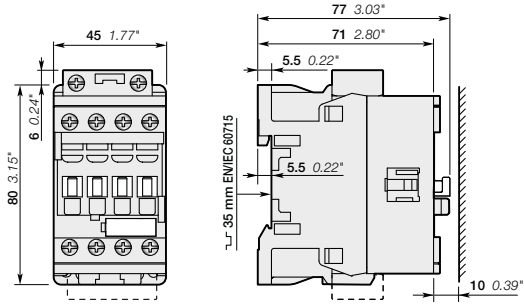

AF09, AF12, AF16

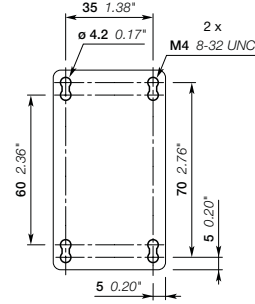

AF09, AF12, AF16

5

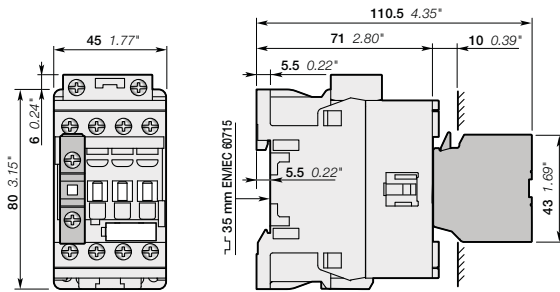

AF09, AF12, AF16
+ CA4, CC4 1-pole auxiliary contact block

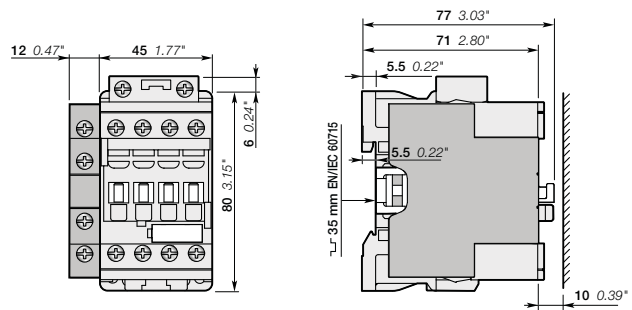

AF09, AF12, AF16
+ CAL4-11 2-pole auxiliary contact block

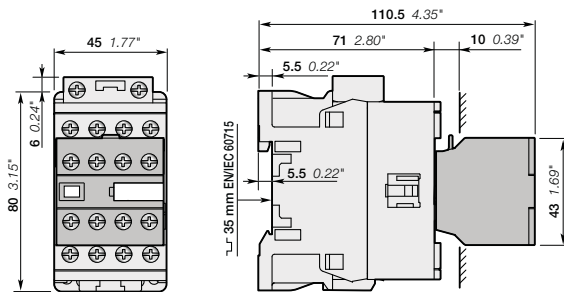

AF09, AF12, AF16
+ CA4 4-pole auxiliary contact block

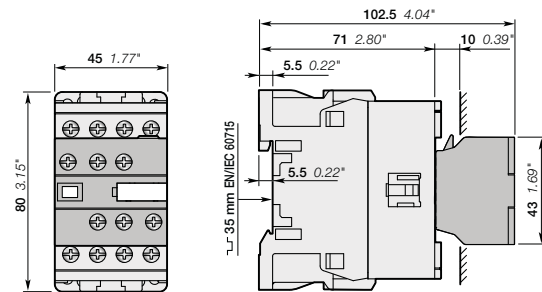

AF09, AF12, AF16
+ CAT4 2-pole auxiliary contact and coil terminal block

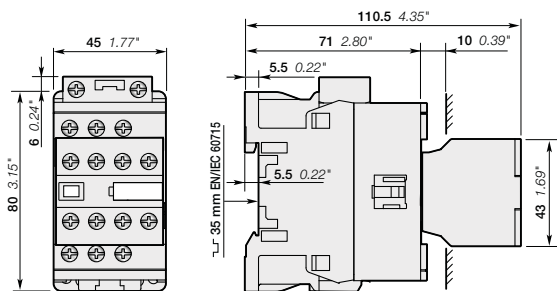

AF09, AF12, AF16...-30-22

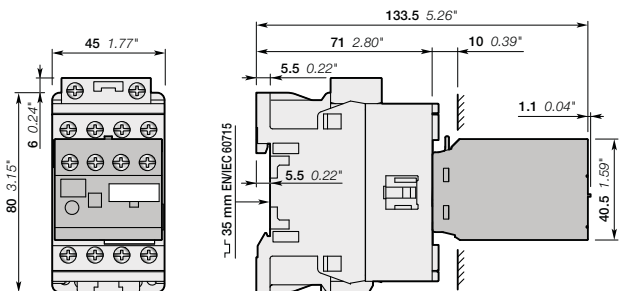

AF09, AF12, AF16
+ TEF4 electronic timer

Note: contactor lateral distance to grounded component 2 mm 0.08" min.

AF09, AF12, AF16 3-pole contactors

Main dimensions mm, inches

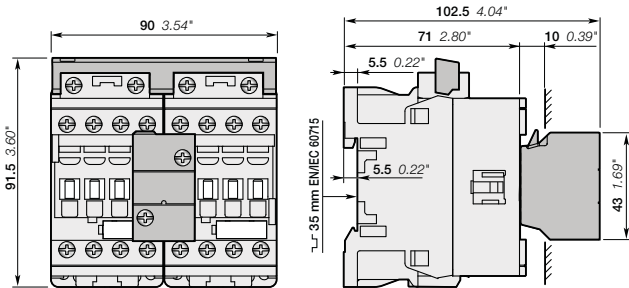

AF09, AF12, AF16

+ VEM4 mechanical and electrical interlock set

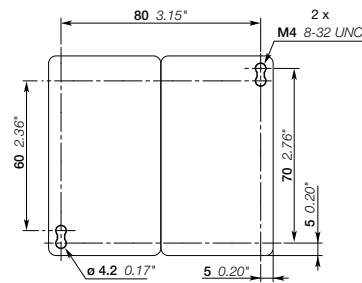

AF09, AF12, AF16

+ VEM4 mechanical and electrical interlock set

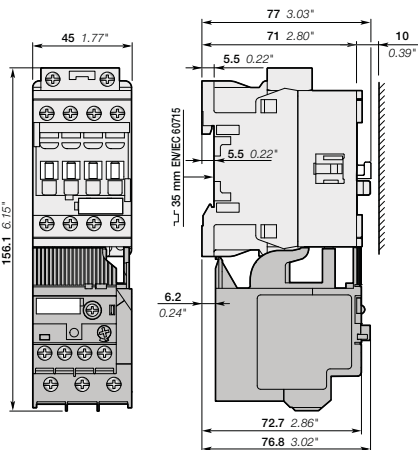

AF09, AF12, AF16

+ TF42 thermal overload relay

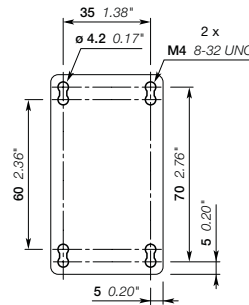

AF09, AF12, AF16

+ TF42, EF19

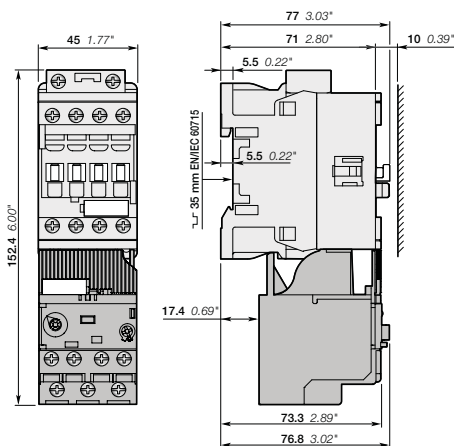

AF09, AF12, AF16 3-pole contactors

+ EF19 electronic overload relay

Note: contactor lateral distance to grounded component 2 mm 0.08" min.

AF26, AF30, AF38 3-pole contactors

Main dimensions mm, inches

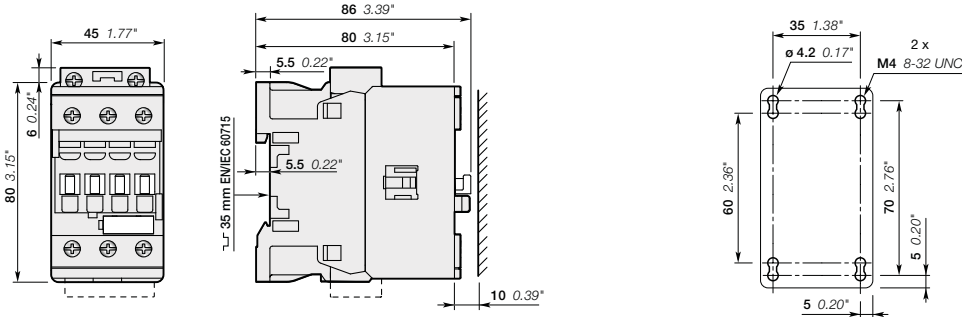

AF26, AF30, AF38

AF26, AF30, AF38

5

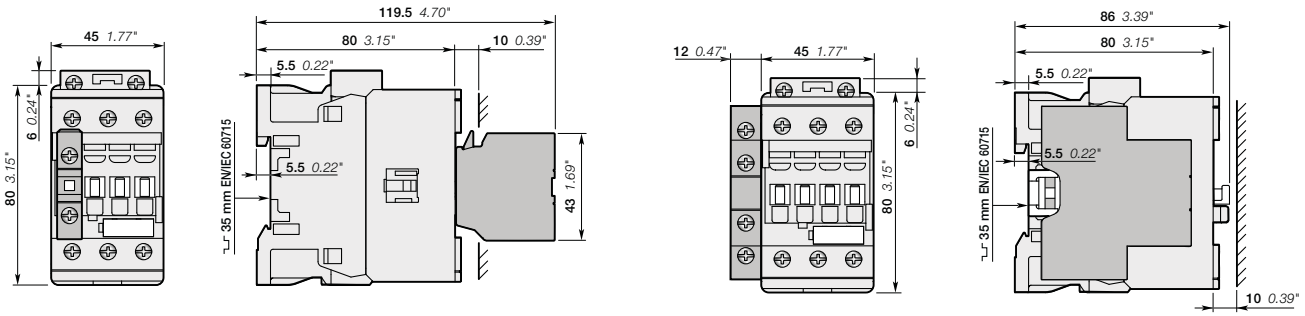

AF26, AF30, AF38

+ CA4, CC4 1-pole auxiliary contact block

AF26, AF30, AF38

+ CAL4-11 2-pole auxiliary contact block

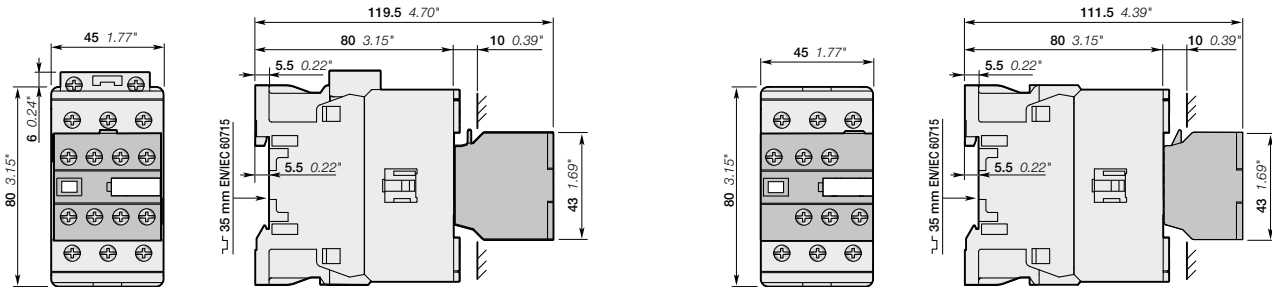

AF26, AF30, AF38

+ CA4 4-pole auxiliary contact block

AF26, AF30, AF38

+ CAT4 2-pole auxiliary contact and coil terminal block

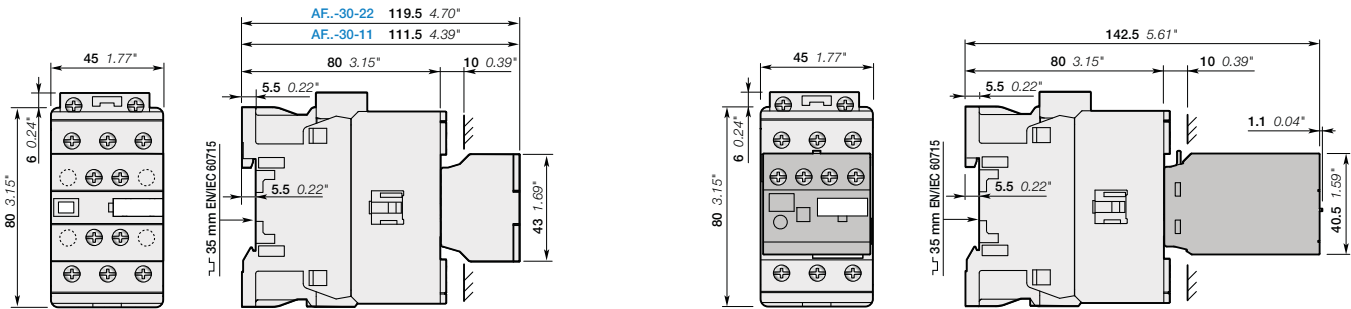

AF26, AF30, AF38...-30-11

AF26, AF30, AF38...-30-22

AF26, AF30, AF38

+ TEF4 electronic timer

Note: contactor lateral distance to grounded component 2 mm 0.08" min.

AF26, AF30, AF38 3-pole contactors

Main dimensions mm, inches

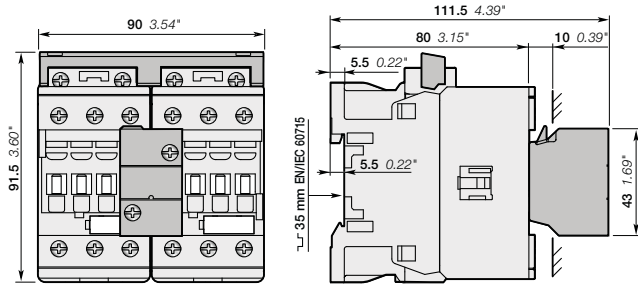

AF26, AF30, AF38
+ VEM4 mechanical and electrical interlock set

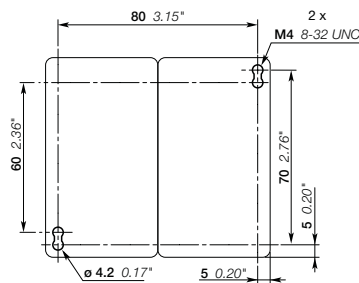

AF26, AF30, AF38
+ VEM4 mechanical and electrical interlock set

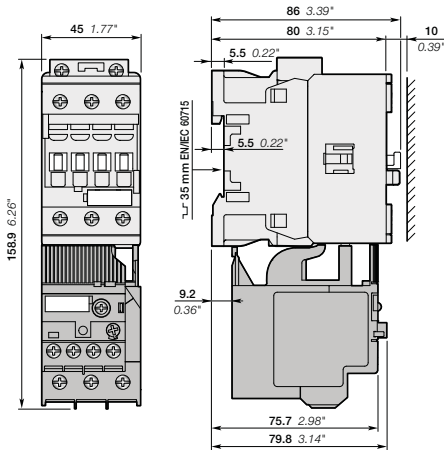

AF26, AF30, AF38
+ TF42 thermal overload relay

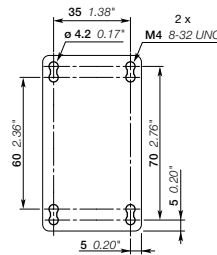

AF26, AF30, AF38
+ TF42, EF19, EF45

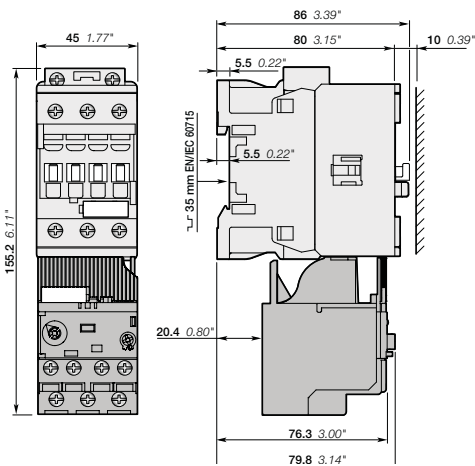

AF26 3-pole contactors
+ EF19 electronic overload relay

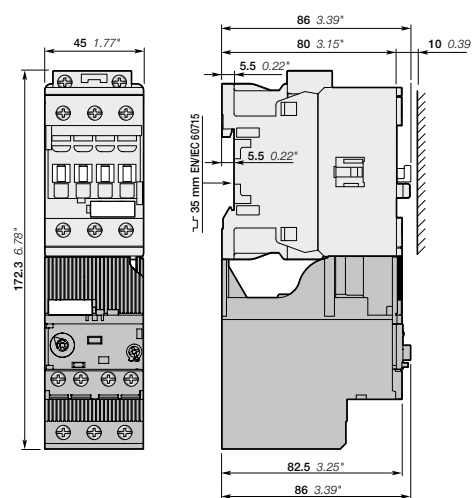

AF26, AF30, AF38 3-pole contactors
+ EF45 electronic overload relay

Note: contactor lateral distance to grounded component 2 mm 0.08" min.

AF40 ... AF65 3-pole contactors

Main dimensions mm, inches

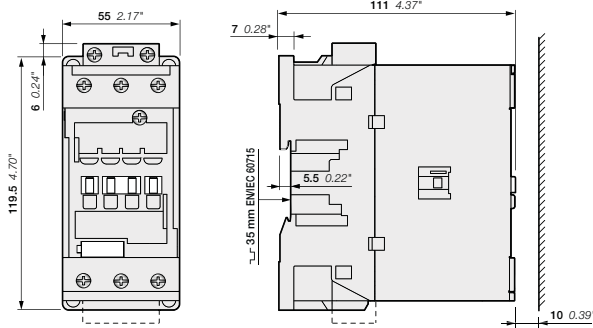

AF40, AF52, AF65

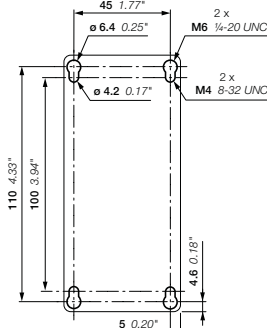

AF40, AF52, AF65

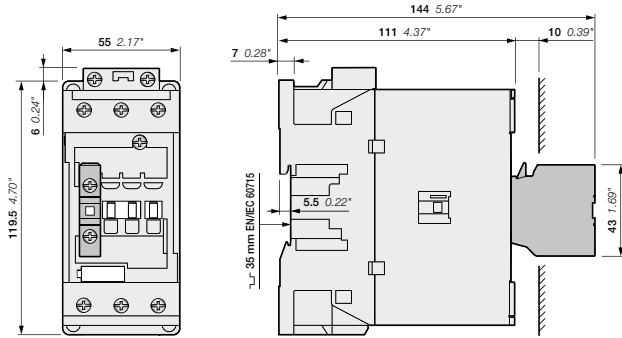

AF40, AF52, AF65
+ CA4, CC4 1-pole auxiliary contact block

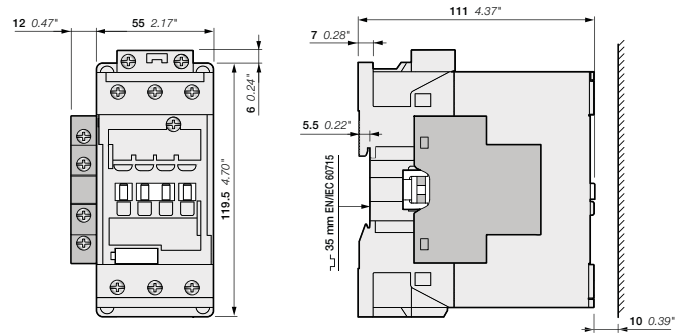

AF40, AF52, AF65-30-00 + CAL4-11 2-pole auxiliary contact block
AF40, AF52, AF65-30-11

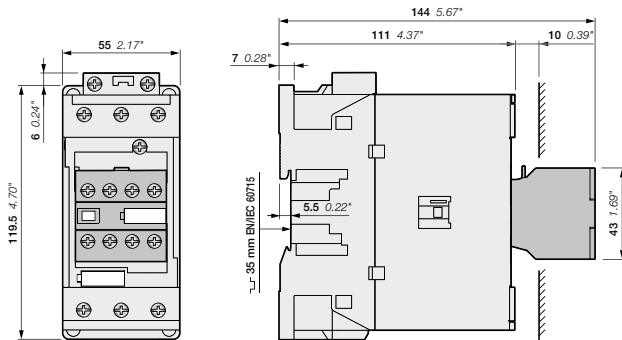

AF40, AF52, AF65
+ CA4 4-pole auxiliary contact block

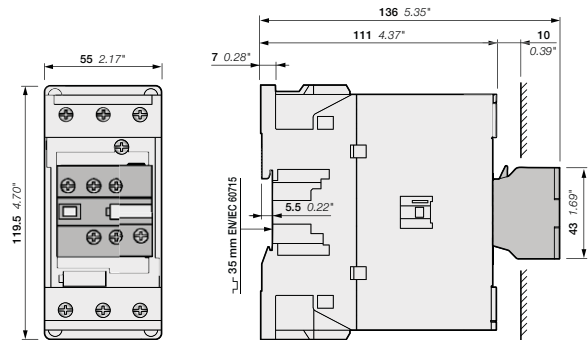

AF40, AF52, AF65
+ CAT4 2-pole auxiliary contact and coil terminal block

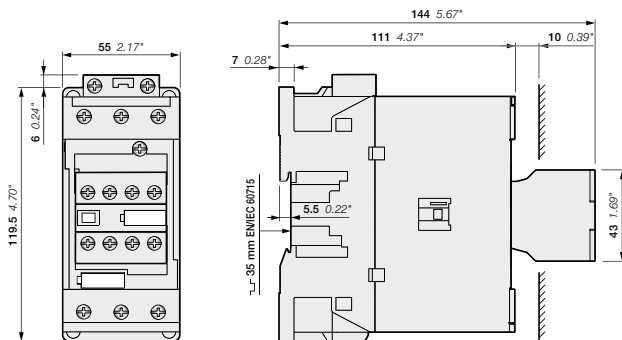

AF40, AF52, AF65...-30-22

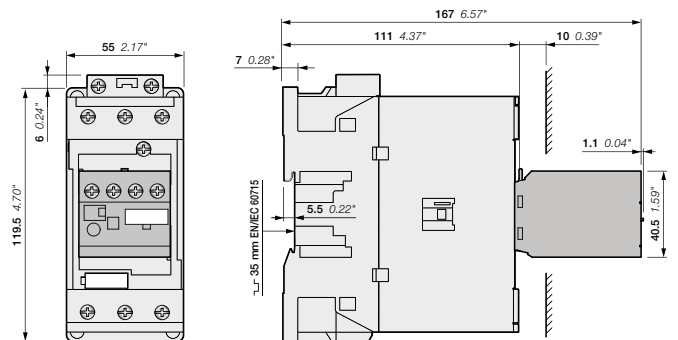

AF40, AF52, AF65
+ TEF4 electronic timer

AF40 ... AF65 3-pole contactors

Main dimensions mm, inches

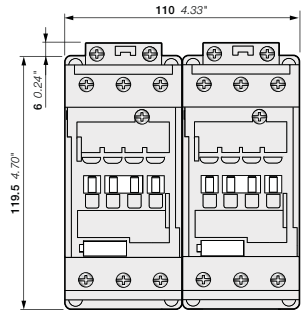

AF40, AF52, AF65
+ VM96-4 mechanical interlock unit

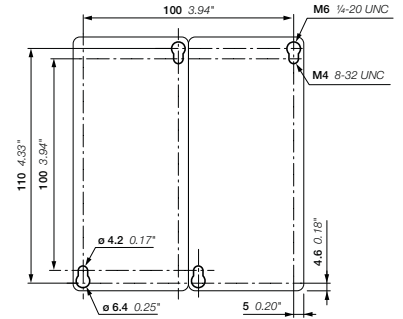
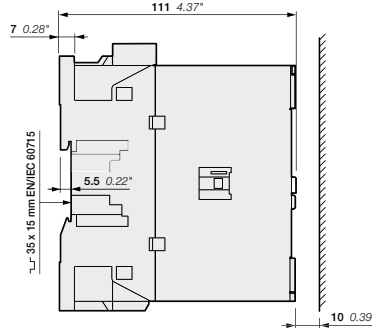

AF40, AF52, AF65
+ VM96-4 mechanical interlock set

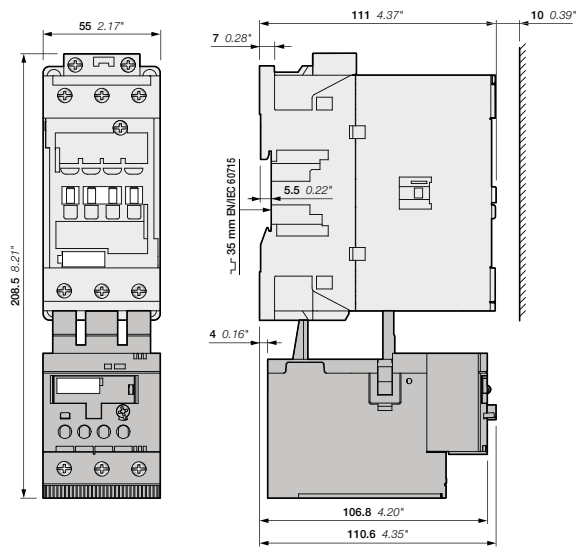

AF40, AF52, AF65
+ TF65 thermal overload relay

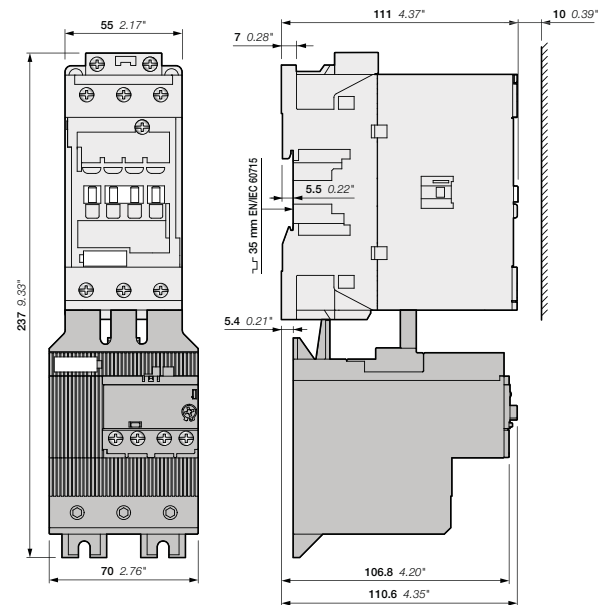

AF40, AF52, AF65
+ EF65 electronic overload relay

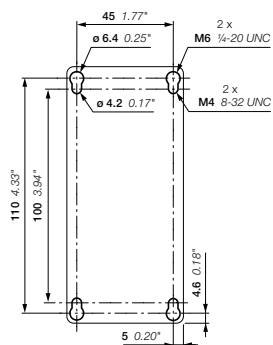

AF40, AF52, AF65
+ TF65, EF65

AF80 ... AF96 3-pole contactors

Main dimensions mm, inches

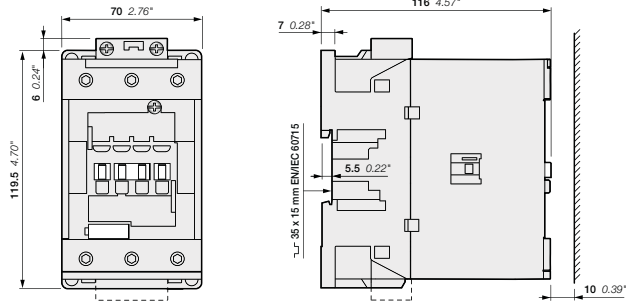

AF80, AF96

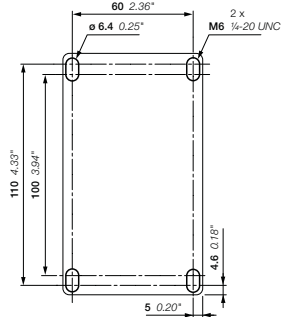

AF80, AF96

5

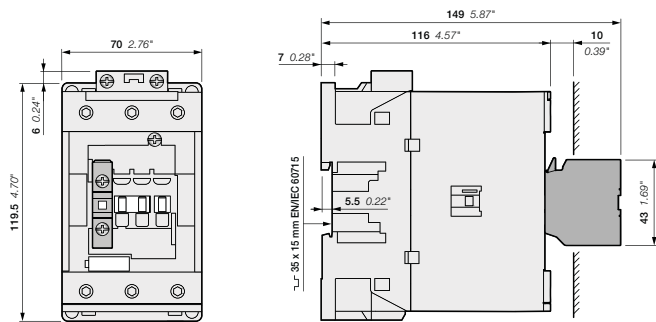

AF80, AF96
+ CA4, CC4 1-pole auxiliary contact block

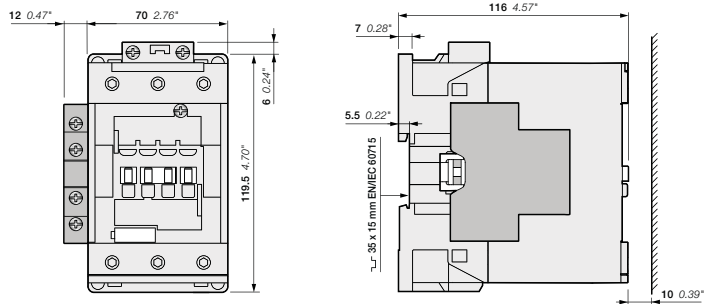

AF80, AF96-30-00 + CAL4-11 2-pole auxiliary contact block
AF80, AF96-30-11

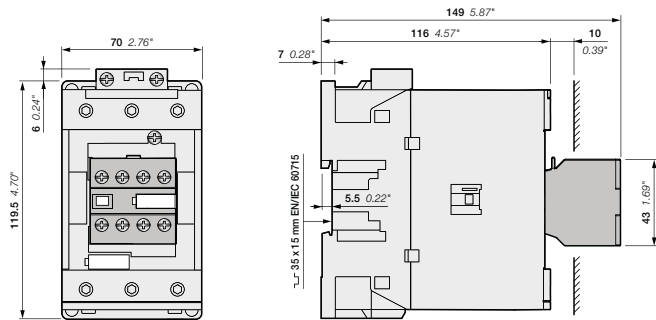

AF80, AF96
+ CA4 4-pole auxiliary contact block

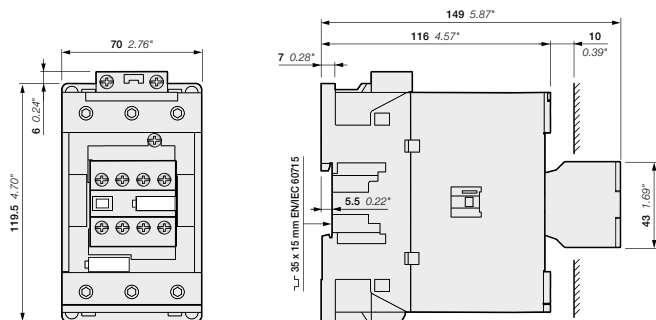

AF80, AF96...-30-22

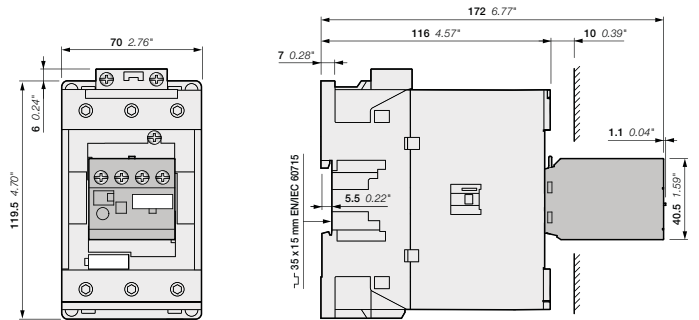

AF80, AF96
+ TEF4 electronic timer

1SBC101732S0201

AF80 ... AF96 3-pole contactors

Main dimensions mm, inches

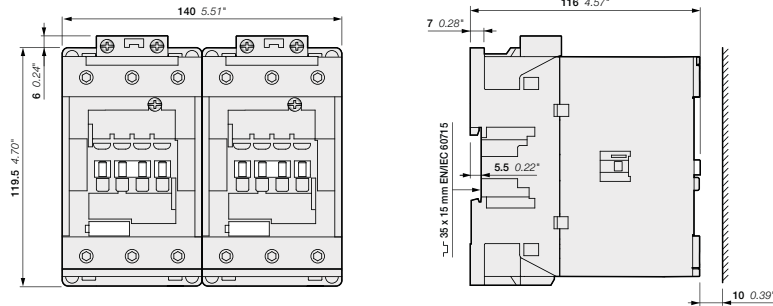

AF80, AF96
+ VM96-4 mechanical interlock unit

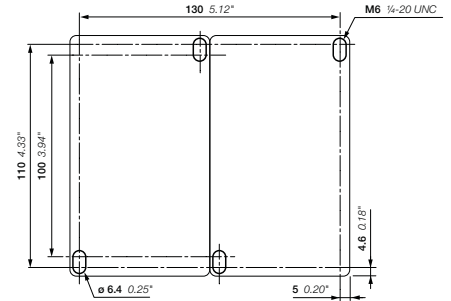

AF80, AF96
+ VM96-4 mechanical interlock set

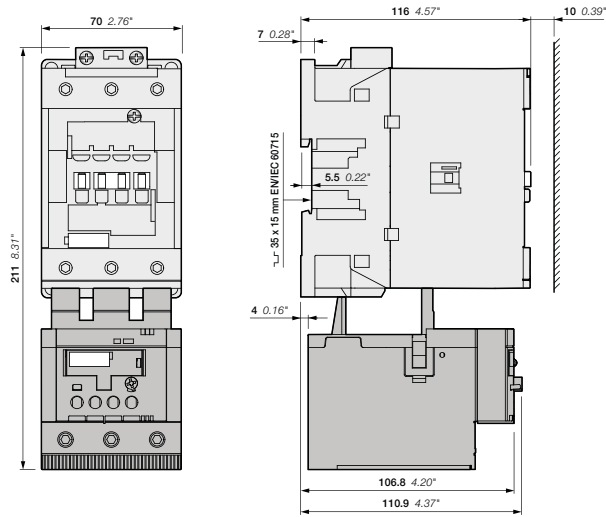

AF80, AF96
+ TF96 thermal overload relay

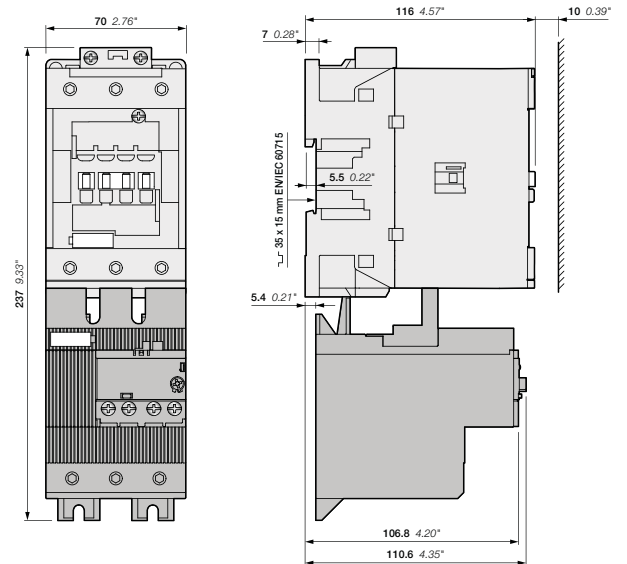

AF80, AF96
+ EF96 electronic overload relay

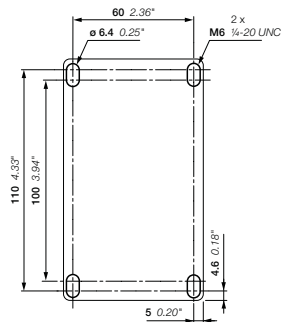

AF80, AF96
+ TF96, EF96

AF116, AF140, AF146 3-pole contactors

Main dimensions mm, inches

SECTION D-D

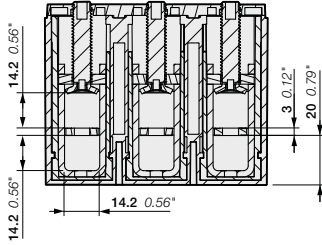

SECTION E-E

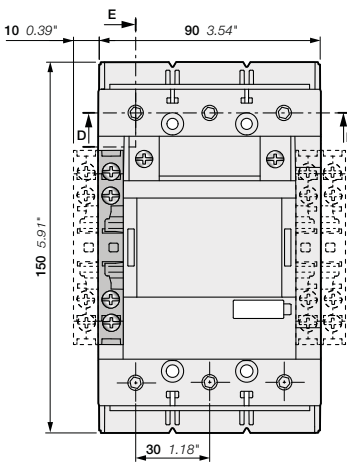
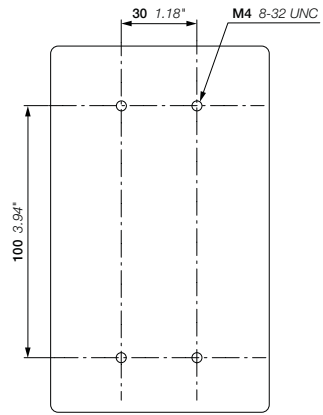
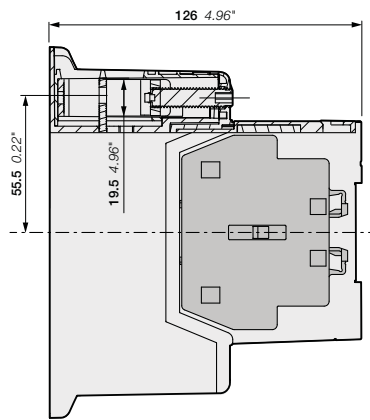

AF116, AF140, AF146-30-00 + CAL19 2-pole auxiliary contact block
AF116, AF140, AF146-30-11

AF116, AF140, AF146-30...(B)

SECTION D-D

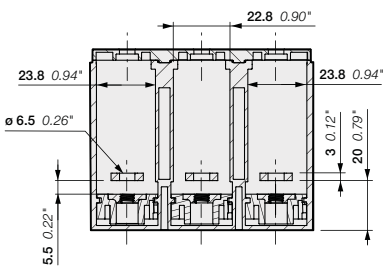

SECTION E-E

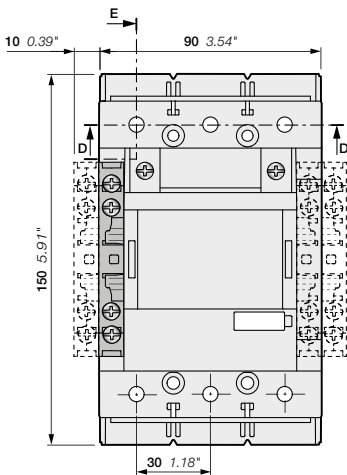
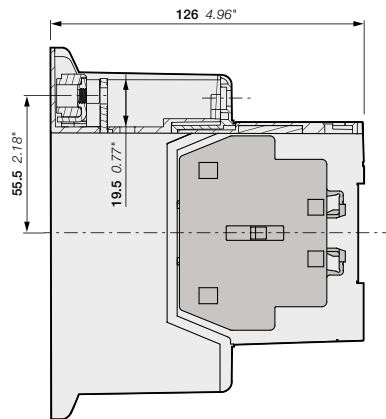

AF116, AF140, AF146-30-00B + CAL19 2-pole auxiliary contact block
AF116, AF140, AF146-30-11B

AF116, AF140, AF146 3-pole contactors

With built-in PLC interface (coil code 33, 34)

Main dimensions mm, inches

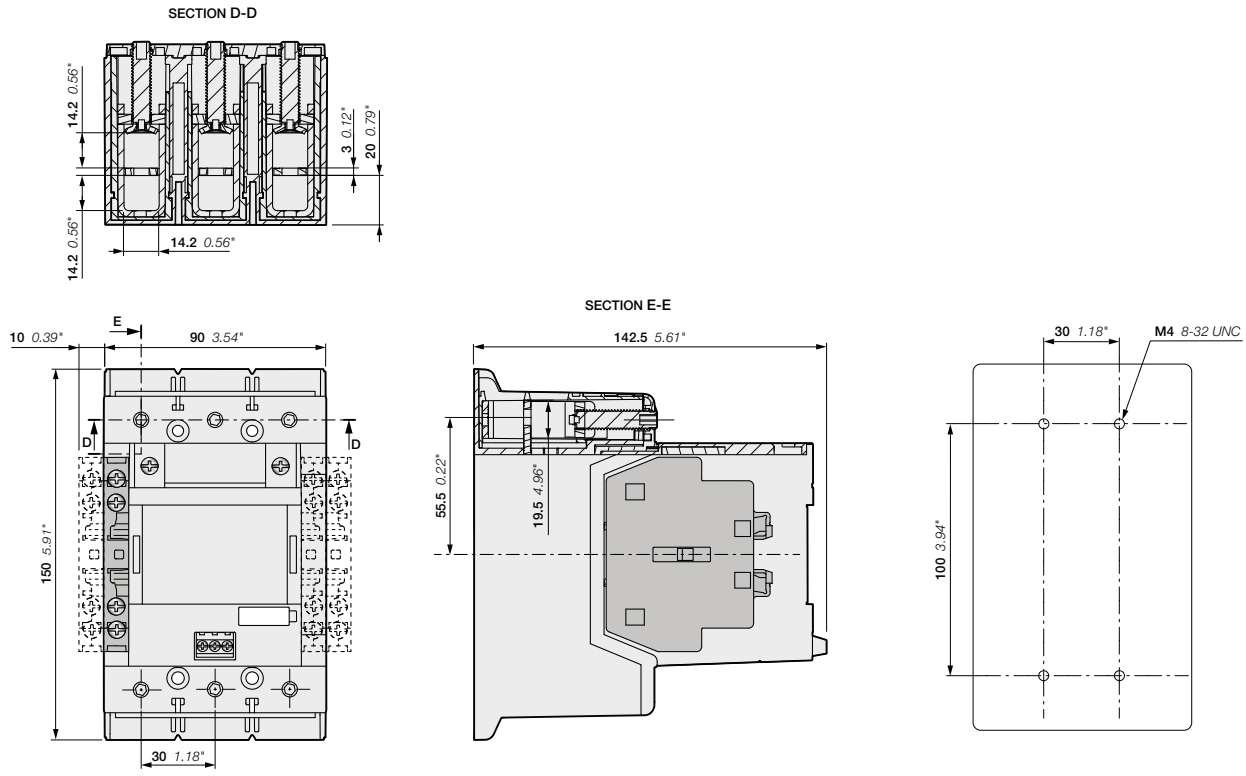

AF116, AF140, AF146-30-00 + CAL19 2-pole auxiliary contact block
AF116, AF140, AF146-30-11

AF116, AF140, AF146-30-...(B)

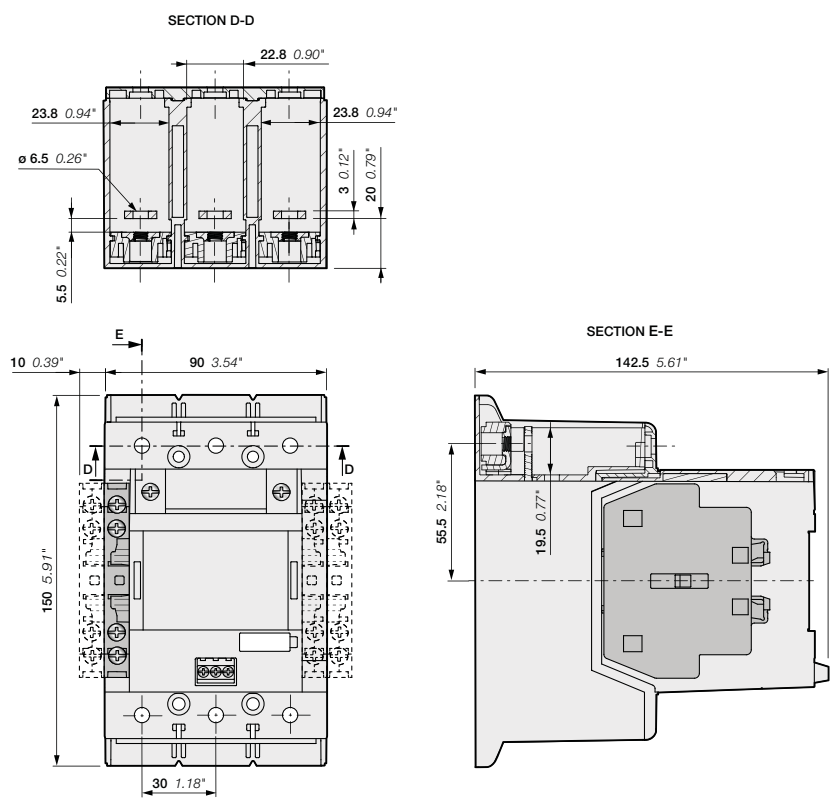

AF116, AF140, AF146-30-00B + CAL19 2-pole auxiliary contact block
AF116, AF140, AF146-30-11B

AF116, AF140, AF146 3-pole contactors

Main dimensions mm, inches

5

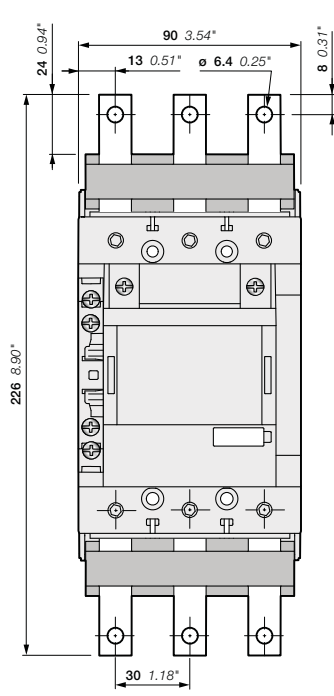

AF116, AF140, AF146-30-11
+ LX140 terminal extension

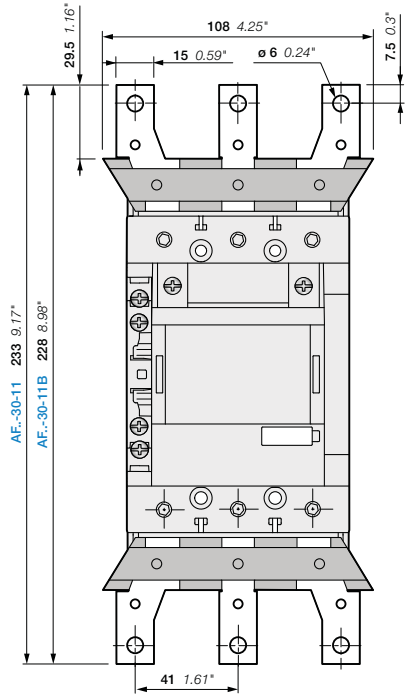

AF116, AF140, AF146-30-11(B)
+ LW140(B) terminal enlargement

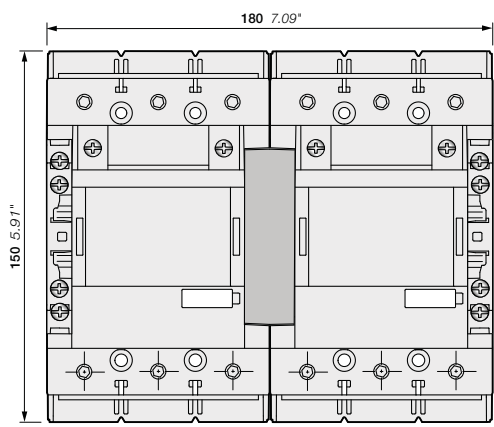
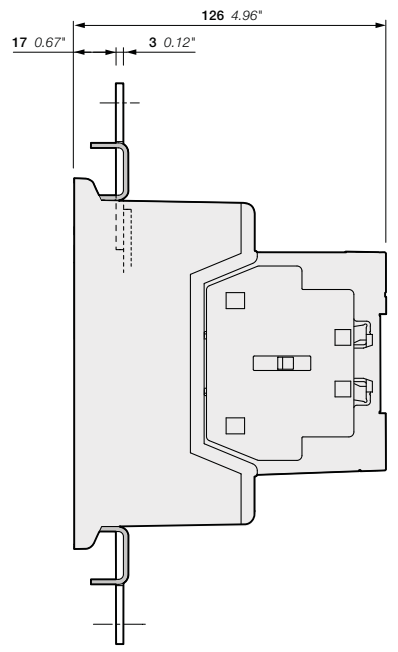

AF116, AF140, AF146-30-11(B)
+ VM19 mechanical interlocking unit

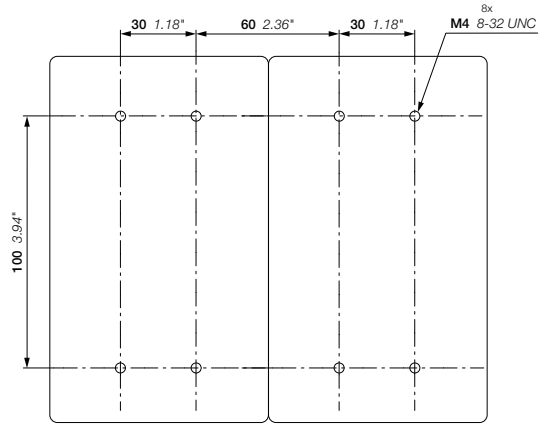
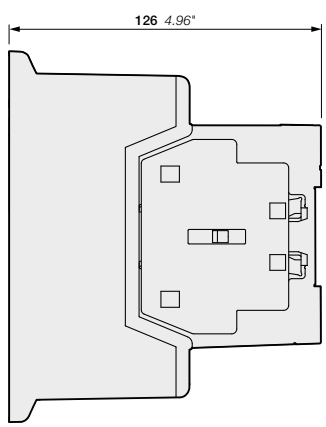

AF116, AF140, AF146-30-11(B)
+ VM19 mechanical interlocking unit

AF116, AF140, AF146 3-pole contactors

Main dimensions mm, inches

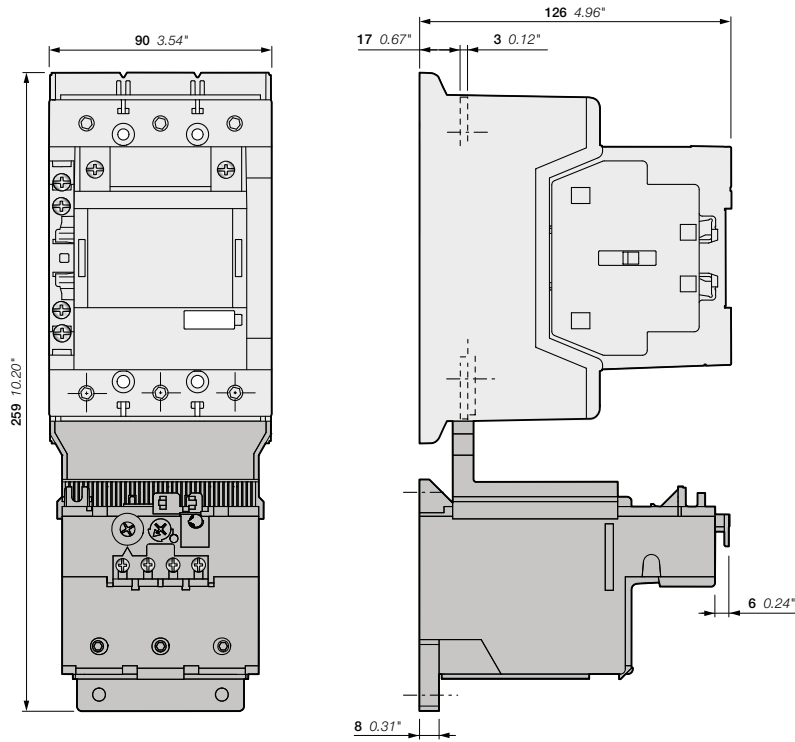

AF116, AF140-30-11(B)
+ TF140 thermal overload relay

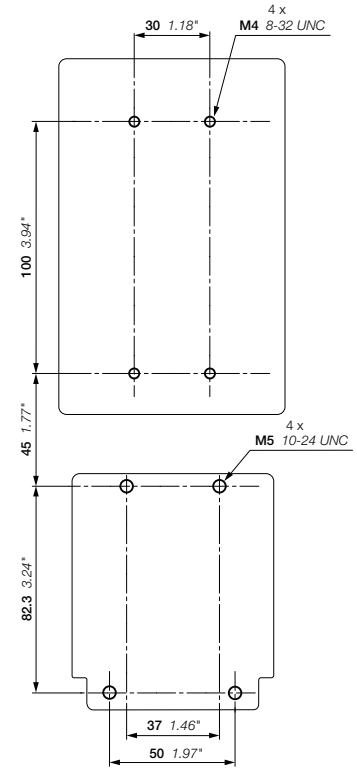

AF116, AF140-30-11(B)
+ TF140 thermal overload relay

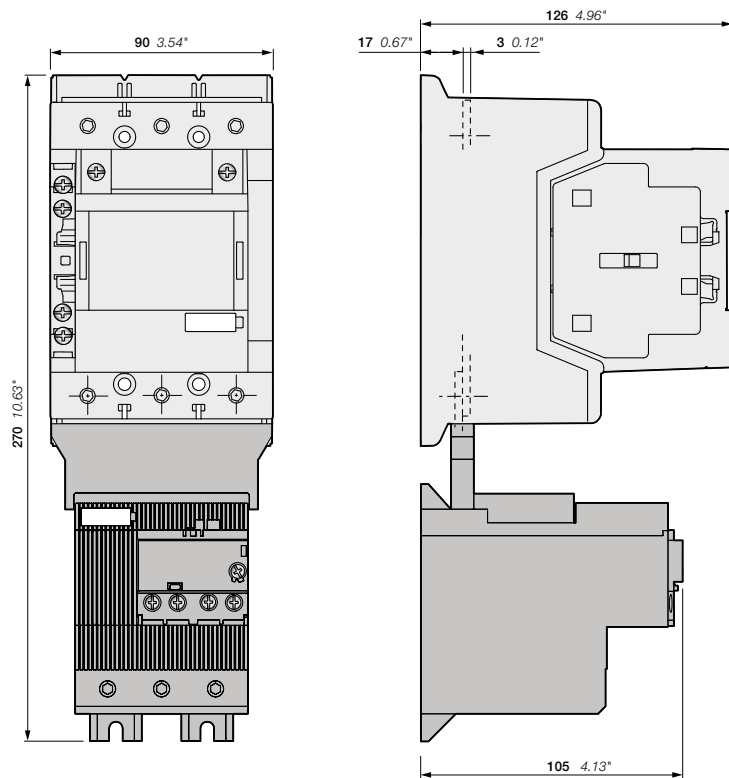

AF116, AF140, AF146-30-11(B)
+ EF146 electronic overload relay

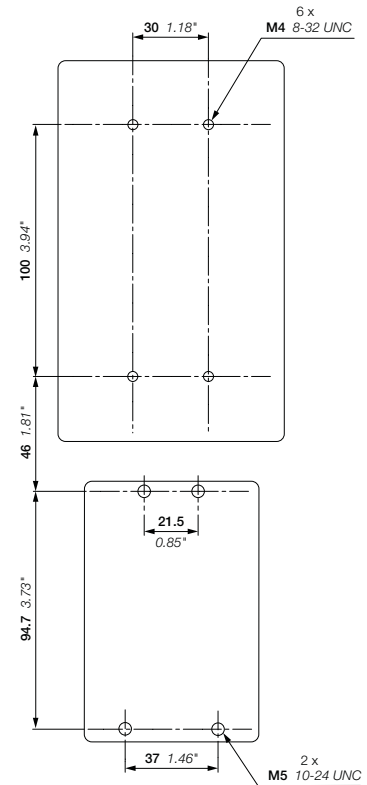

AF116, AF140, AF146-30-11(B)
+ EF146 electronic overload relay

AF190, AF205 3-pole contactors

Main dimensions mm, inches

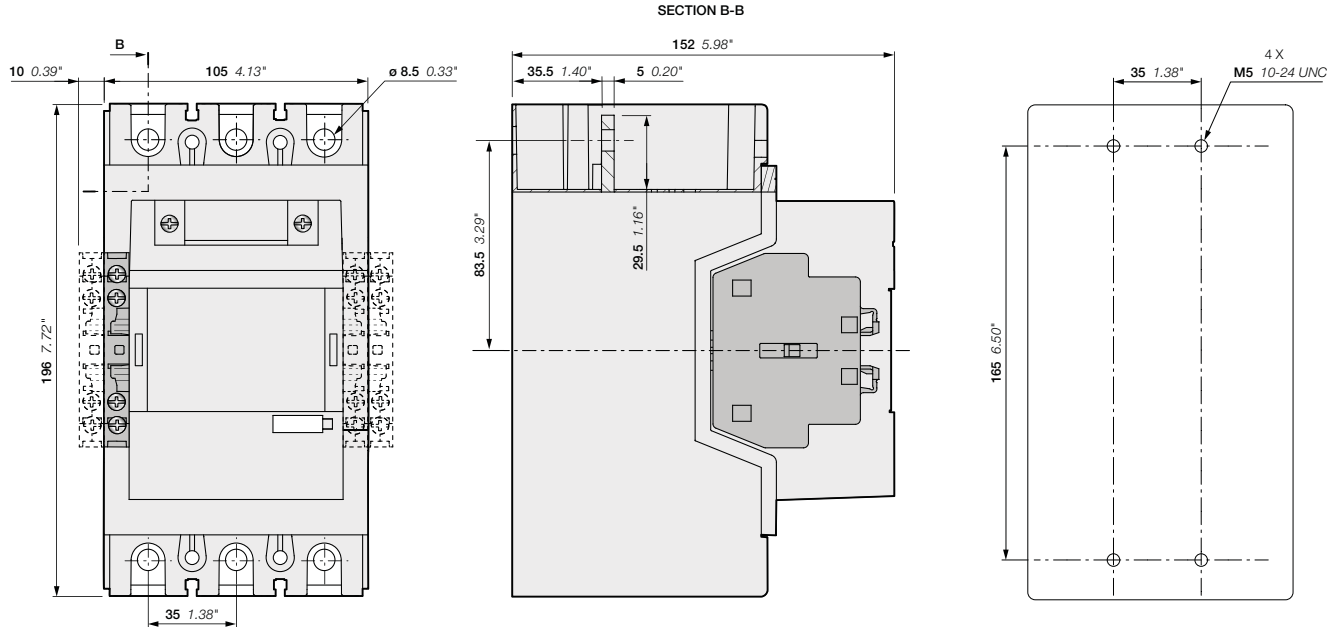

AF190, AF205-30-00 + CAL19 2-pole auxiliary contact block
AF190, AF205-30-11

AF190, AF205

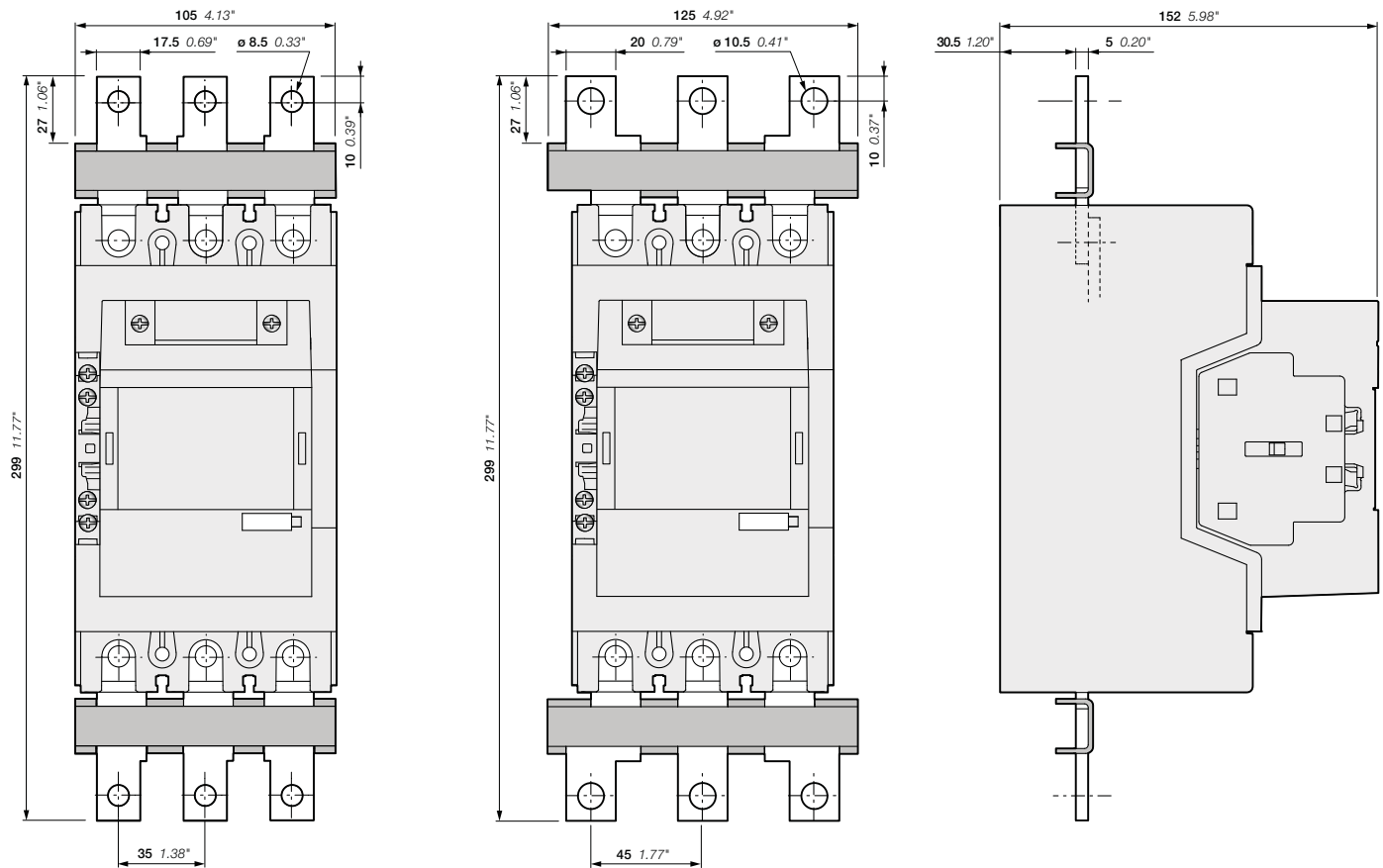

AF190, AF205-30-11
+ LX205 terminal extension

AF190, AF205-30-11
+ LW205 terminal enlargement

AF190, AF205 3-pole contactors

With built-in PLC interface (coil code 33, 34)

Main dimensions mm, inches

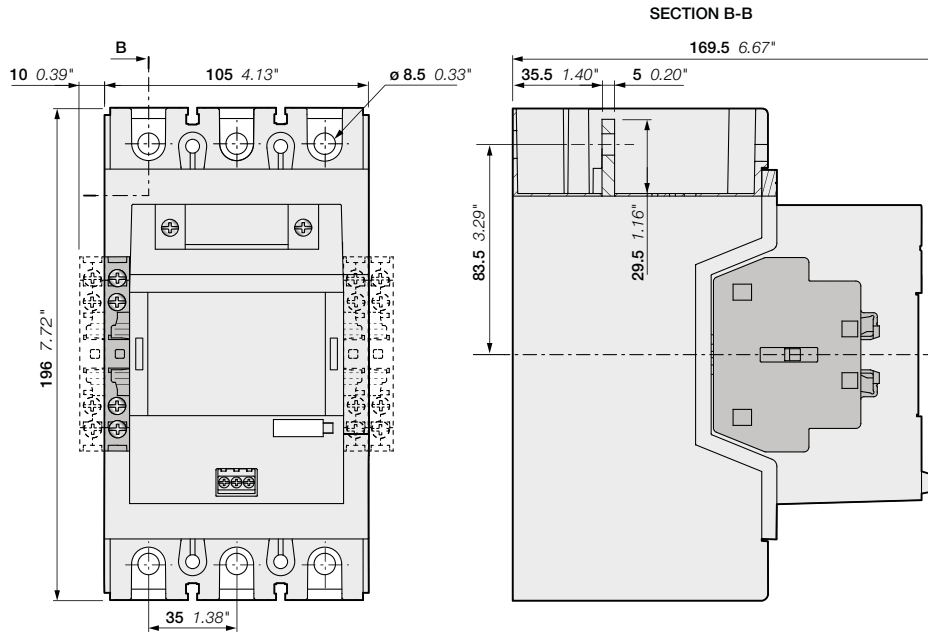

AF190, AF205-30-00 + CAL19 2-pole auxiliary contact block
 AF190, AF205-30-11

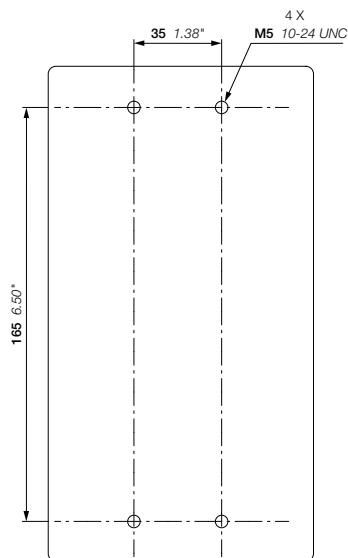

AF190, AF205

AF190, AF205 3-pole contactors

Main dimensions mm, inches

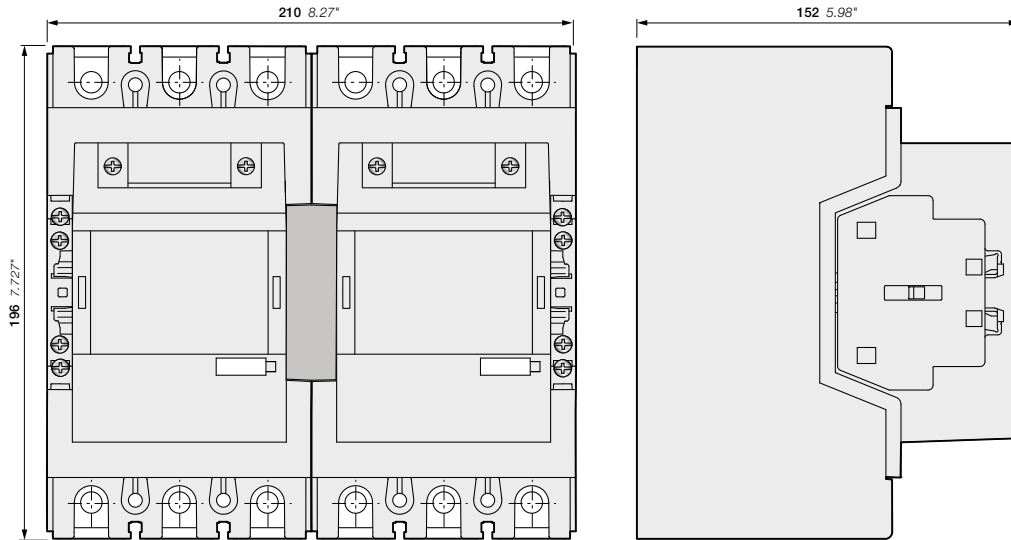

5

AF190, AF205-30-11
+ VM19 mechanical interlocking unit

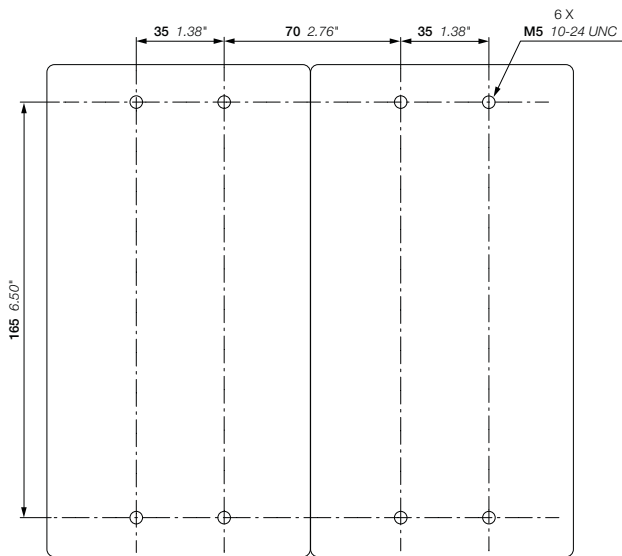

AF190, AF205
+ VM19 mechanical interlocking unit

AF190, AF205 3-pole contactors

Main dimensions mm, inches

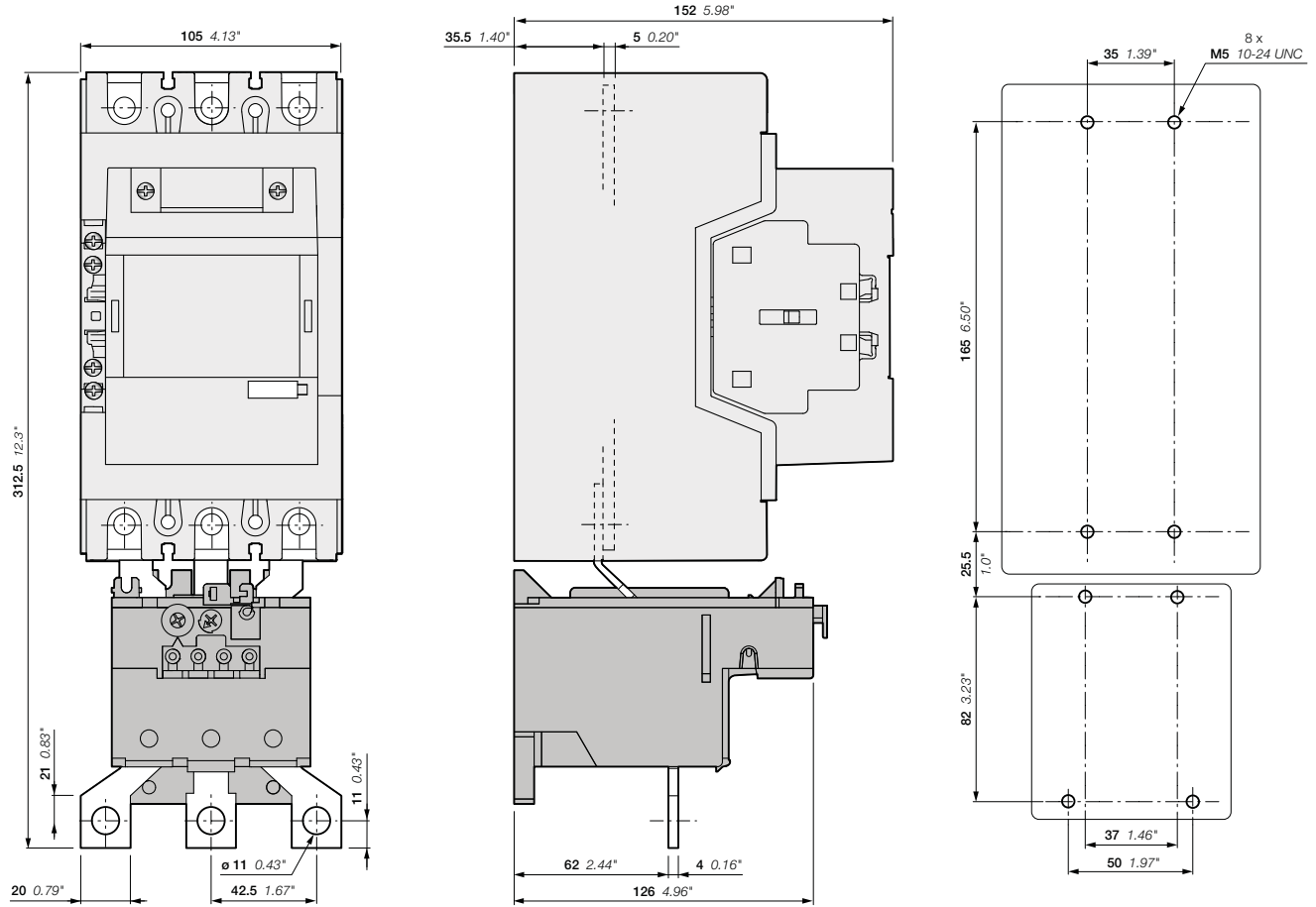

AF190, AF205-30-11
+ TA200DU thermal overload relay

AF190, AF205
+ TA200DU thermal overload relay

AF190, AF205 3-pole contactors

Main dimensions mm, inches

5

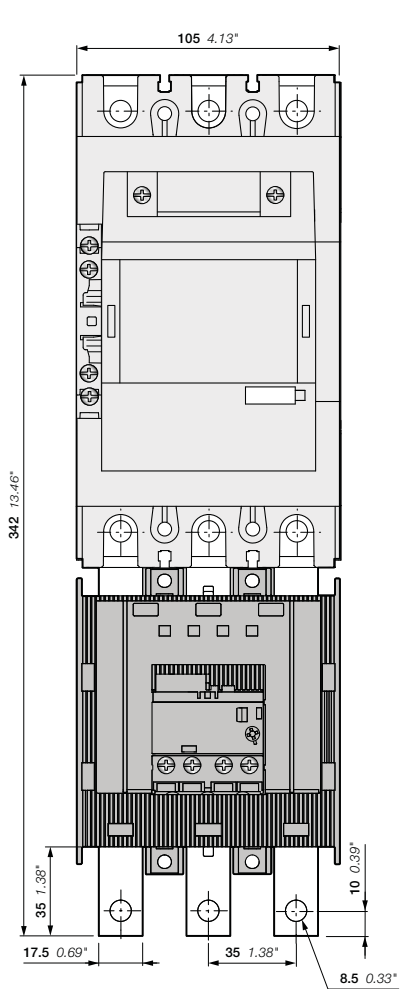

AF190, AF205-30-11
+ EF205 electronic overload relay

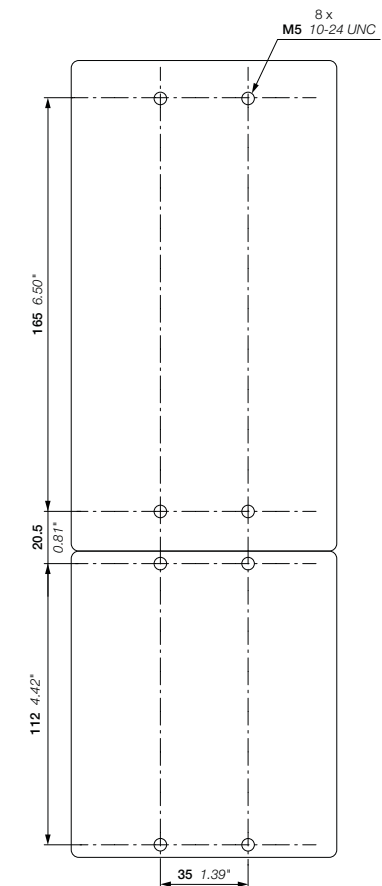
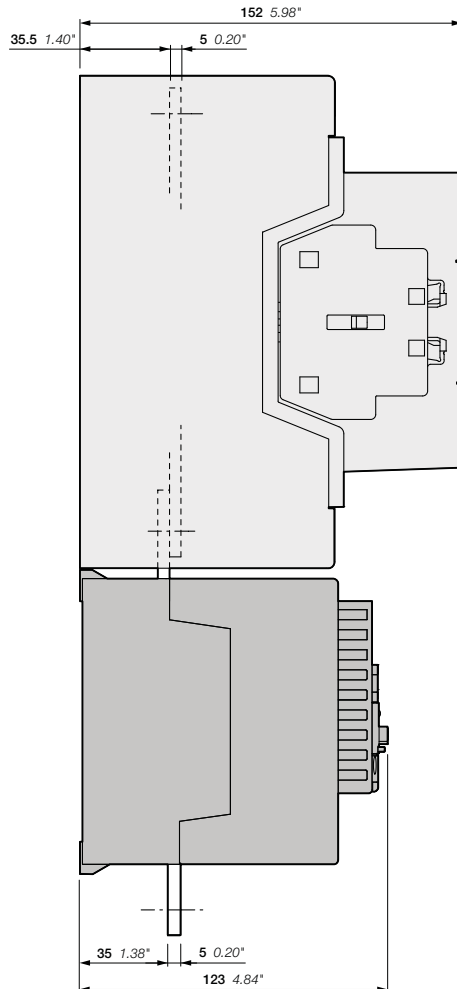

AF190, AF205
+ EF205 electronic overload relay

AF265, AF305, AF370 3-pole contactors

Main dimensions mm, inches

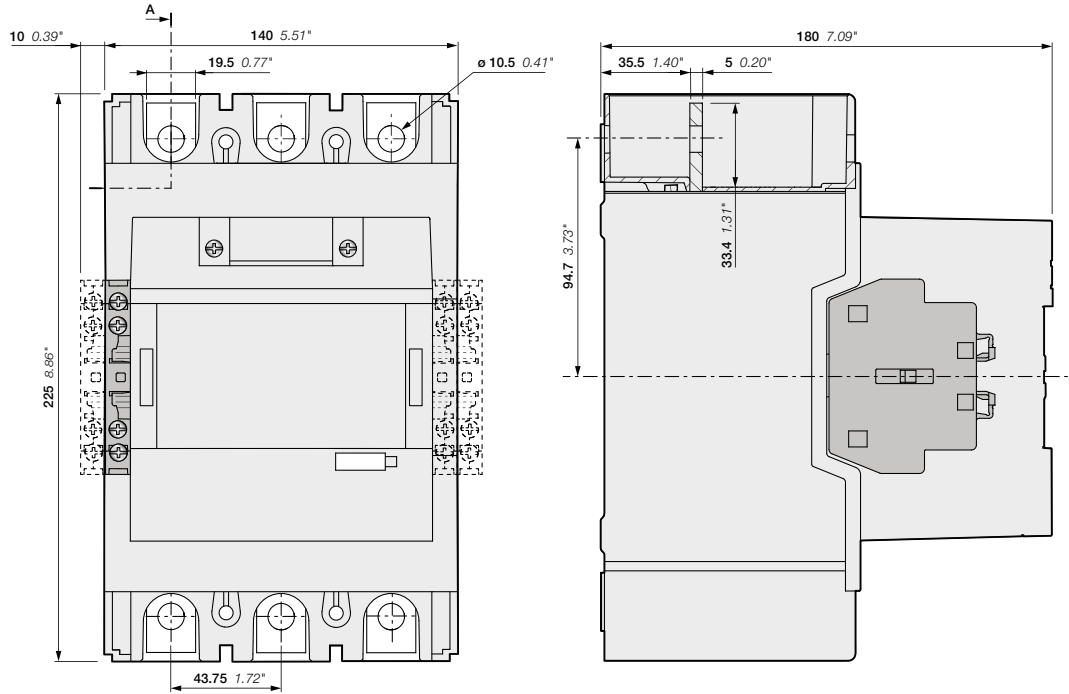

AF265, AF305, AF370-30-00 + CAL19 2-pole contact block
 AF265, AF305, AF370-30-11

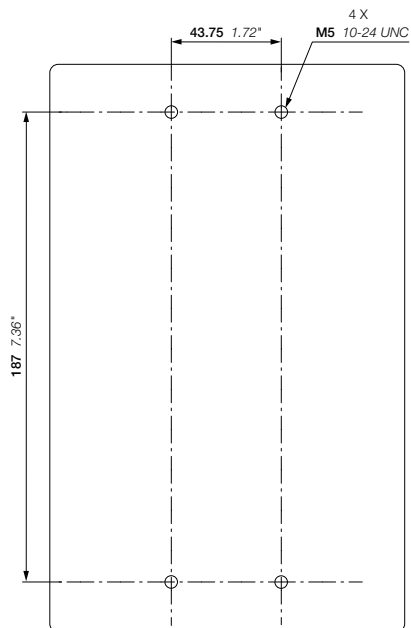

AF265, AF305, AF370

AF265, AF305, AF370 3-pole contactors

Main dimensions mm, inches

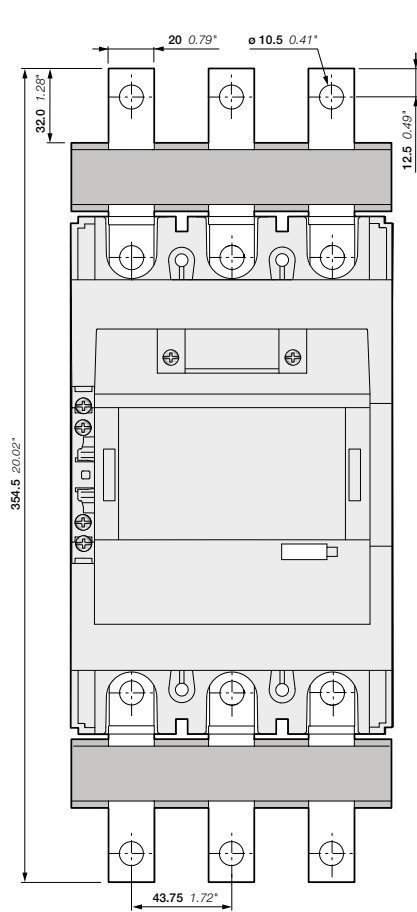

AF265, AF305, AF370-30-11
+ LX370 terminal extension

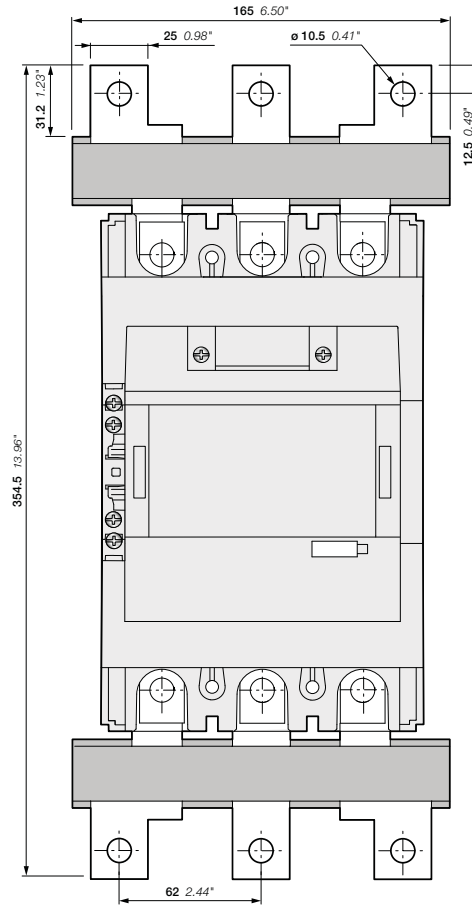

AF265, AF305, AF370-30-11
+ LW370 terminal enlargement

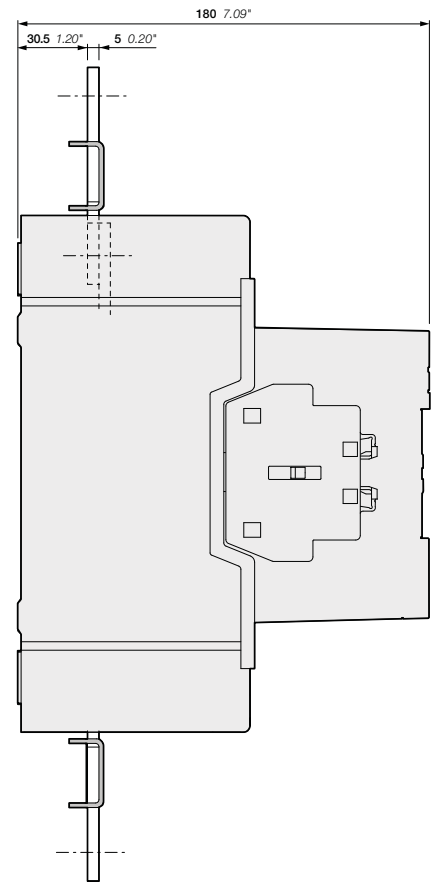

5

AF265, AF305, AF370 3-pole contactors

Main dimensions mm, inches

5

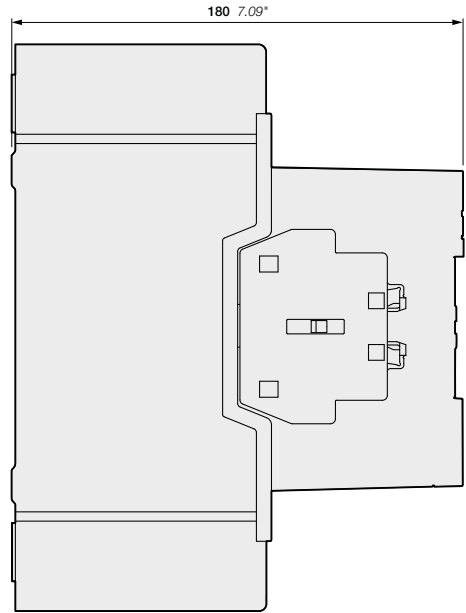
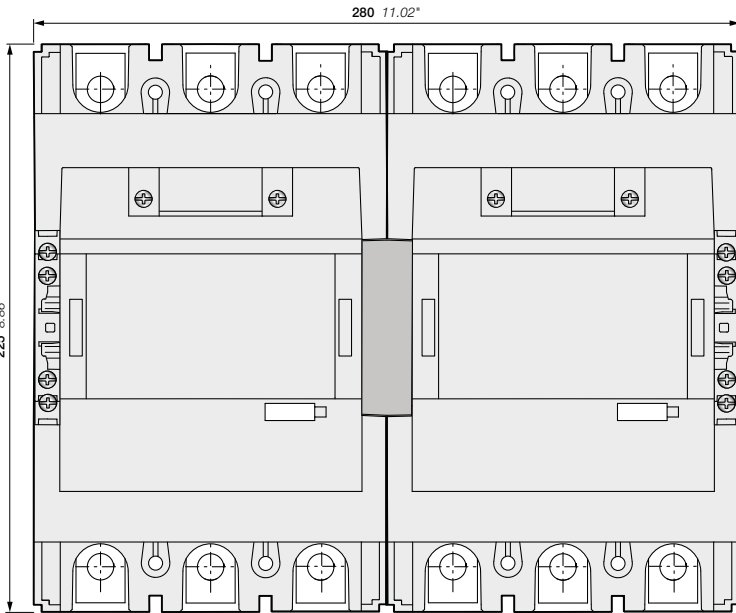

AF265, AF305, AF370-30-11
+ VM19 mechanical interlocking unit

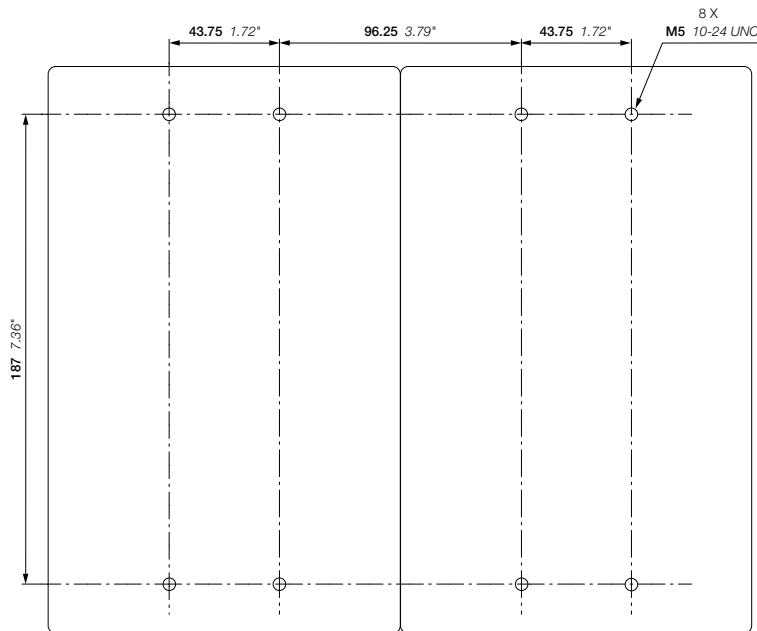

AF265, AF305, AF370
+ VM19 mechanical interlocking unit

AF265, AF305, AF370 3-pole contactors

Main dimensions mm, inches

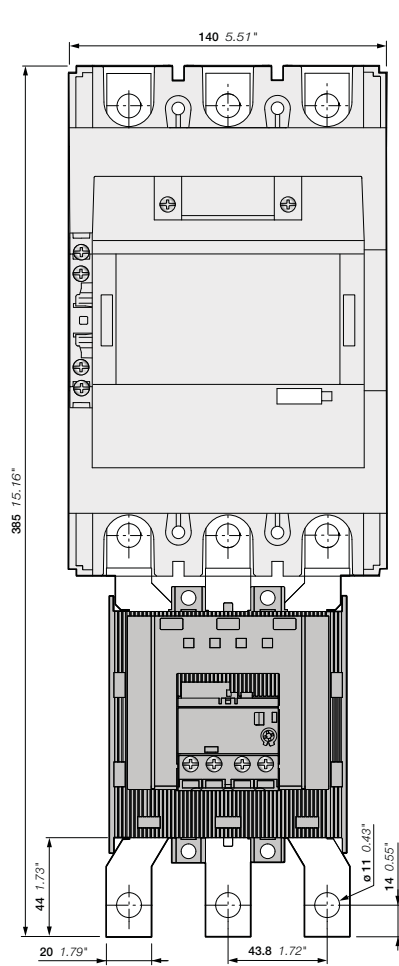

AF265, AF305, AF370-30-11
+ EF370 electronic overload relay

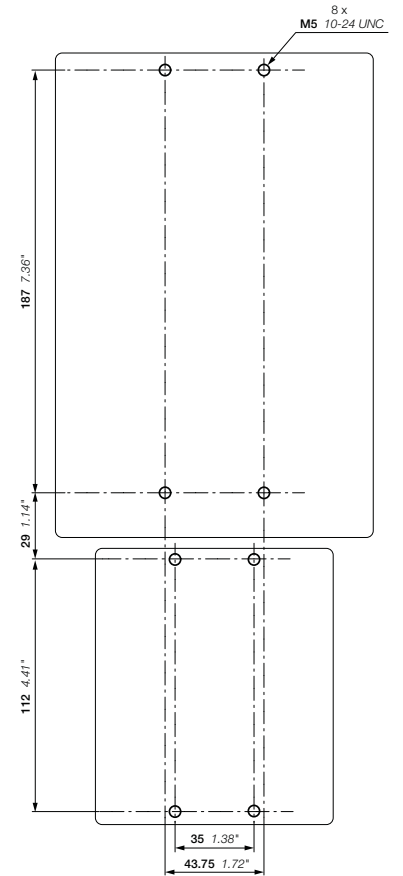
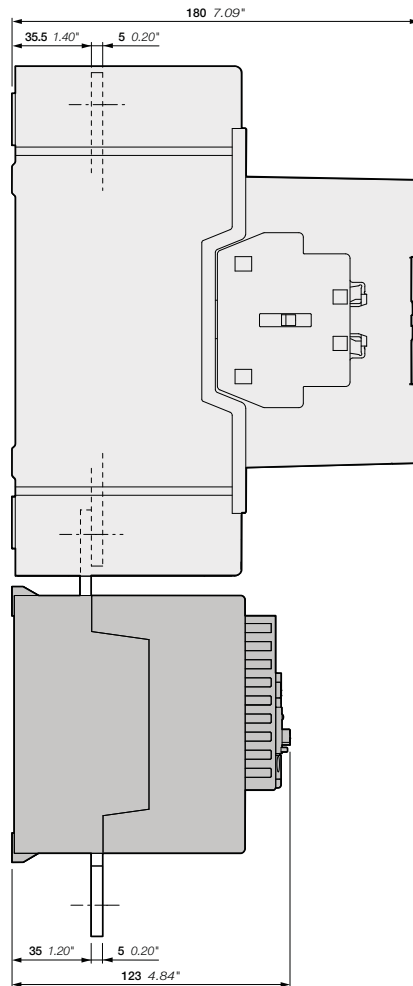

AF265, AF305, AF370
+ EF370 electronic overload relay

AF400 and AF460 3-pole contactors

Main dimensions mm, inches

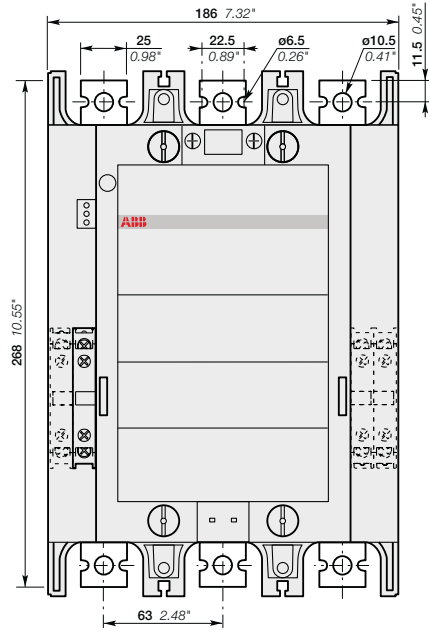

AF400, AF460-30-11

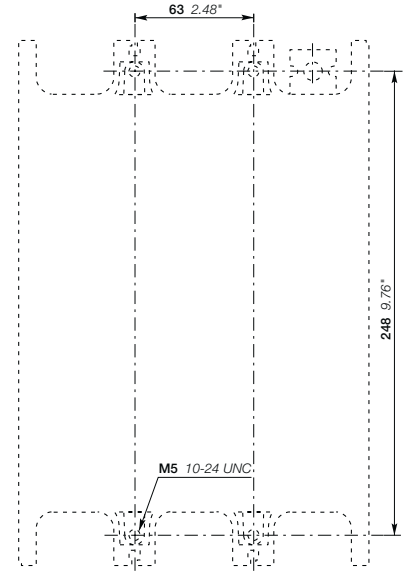
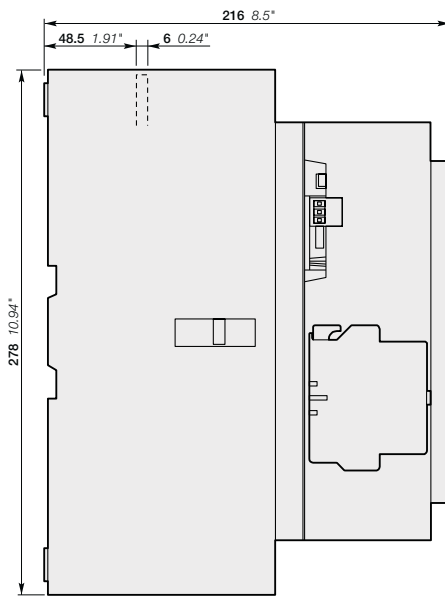

AF400, AF460

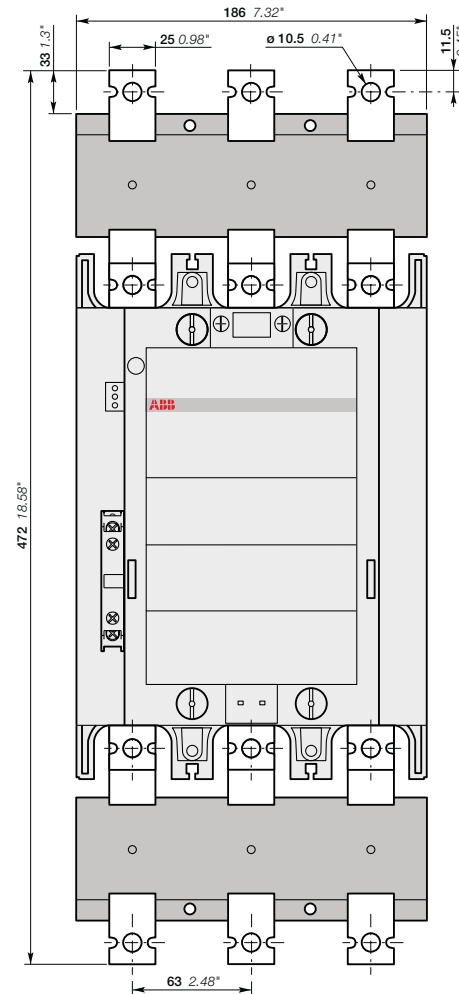

AF400, AF460-30-11
+ LX460 terminal extension

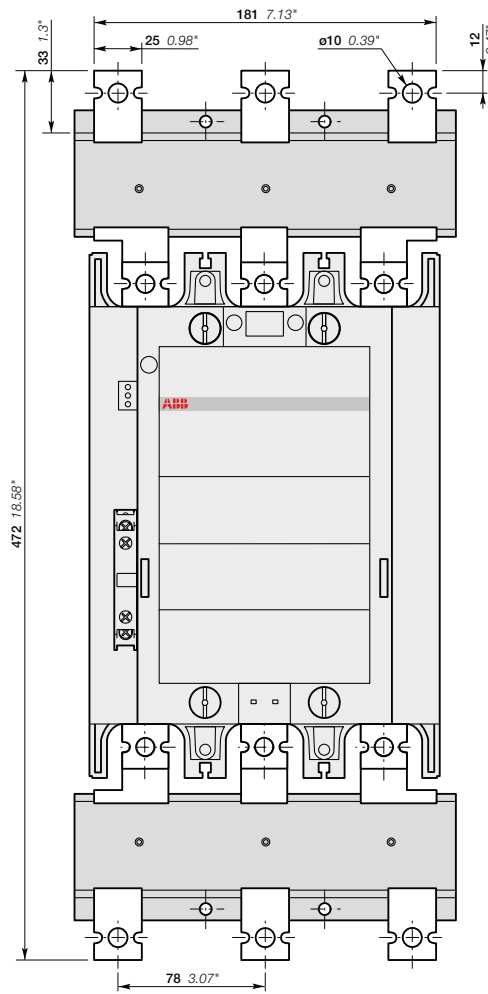

AF400, AF460-30-11
+ LW460 terminal enlargement

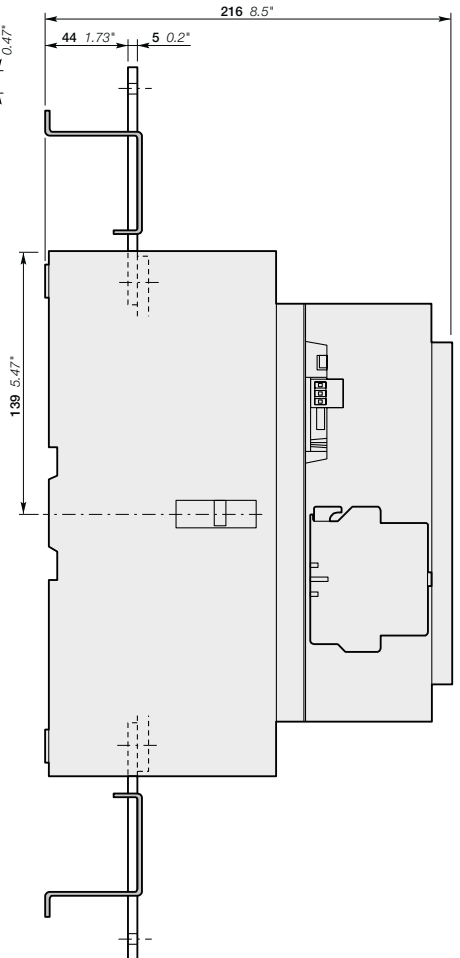

AF400 and AF460 3-pole contactors

Main dimensions mm, inches

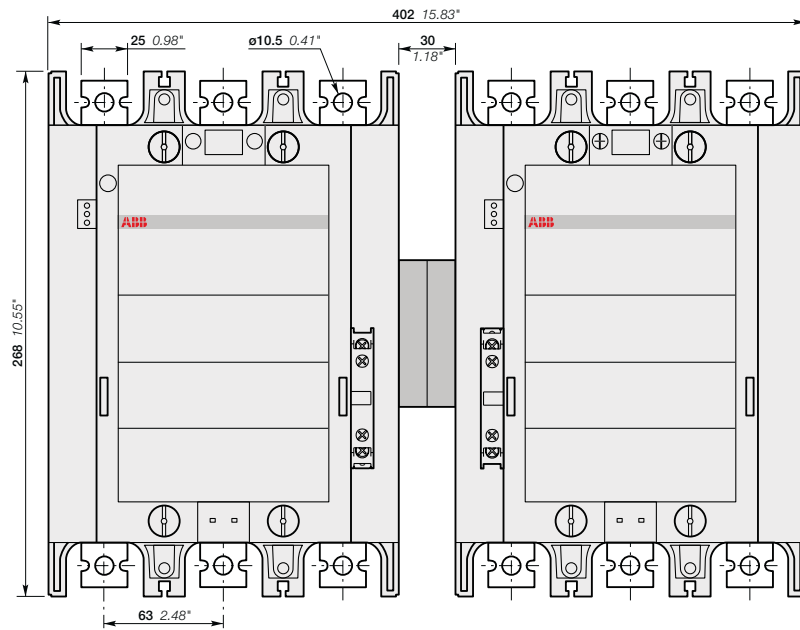

AF400, AF460-30-11
+ VM750H mechanical interlock unit

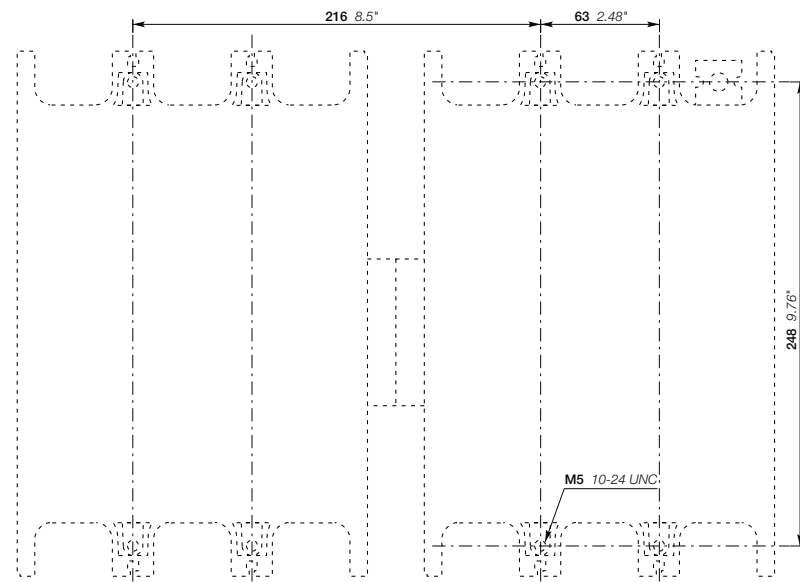
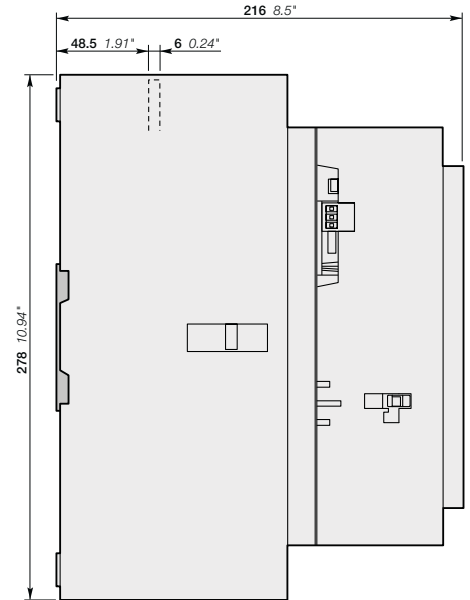

AF400, AF460
+ VM750H mechanical interlock unit

AF400 and AF460 3-pole contactors

Main dimensions mm, inches

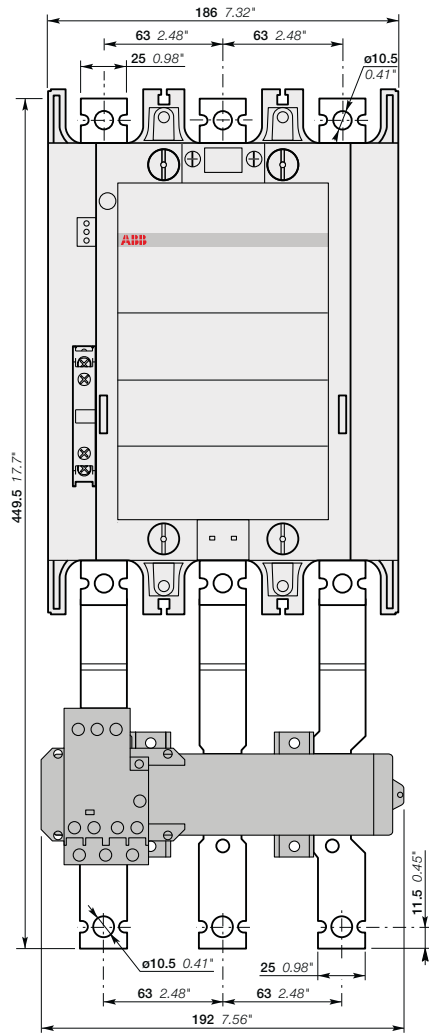

AF400, AF460-30-11
+ E500DU electronic O/L relay

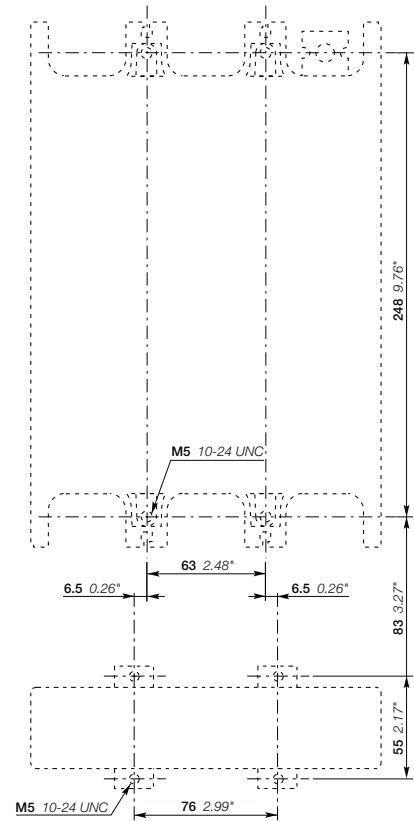
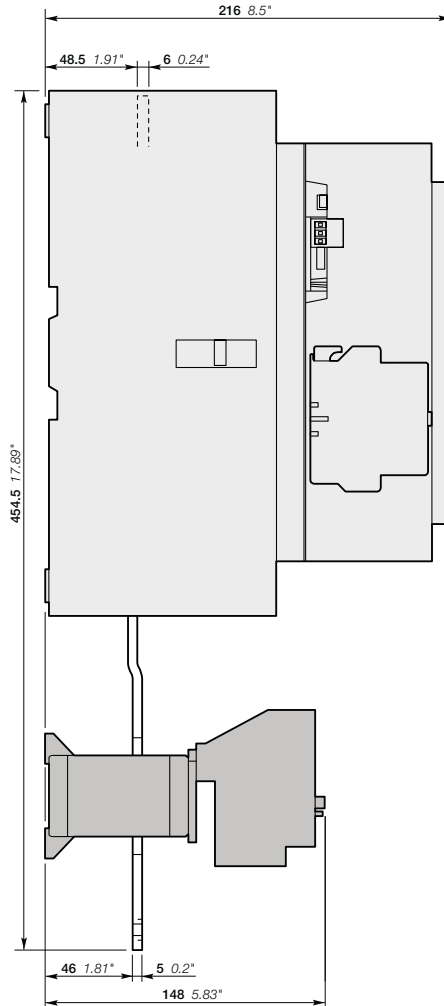

AF400, AF460
+ E500DU electronic O/L relay

AF580 and AF750 3-pole contactors

Main dimensions mm, inches

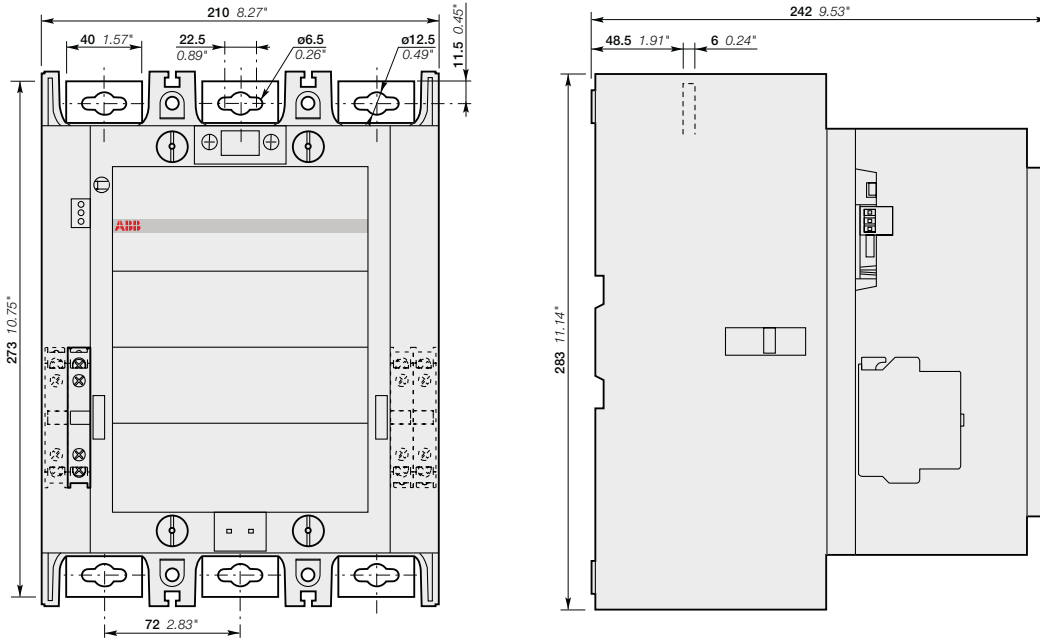

AF580 and AF750-30-11

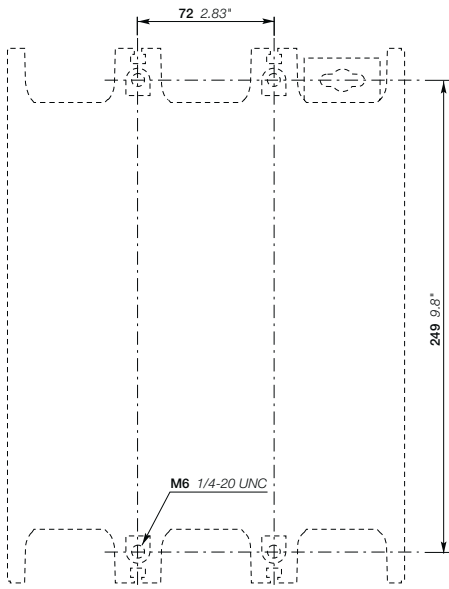

AF580 and AF750

AF580 and AF750 3-pole contactors

Main dimensions mm, inches

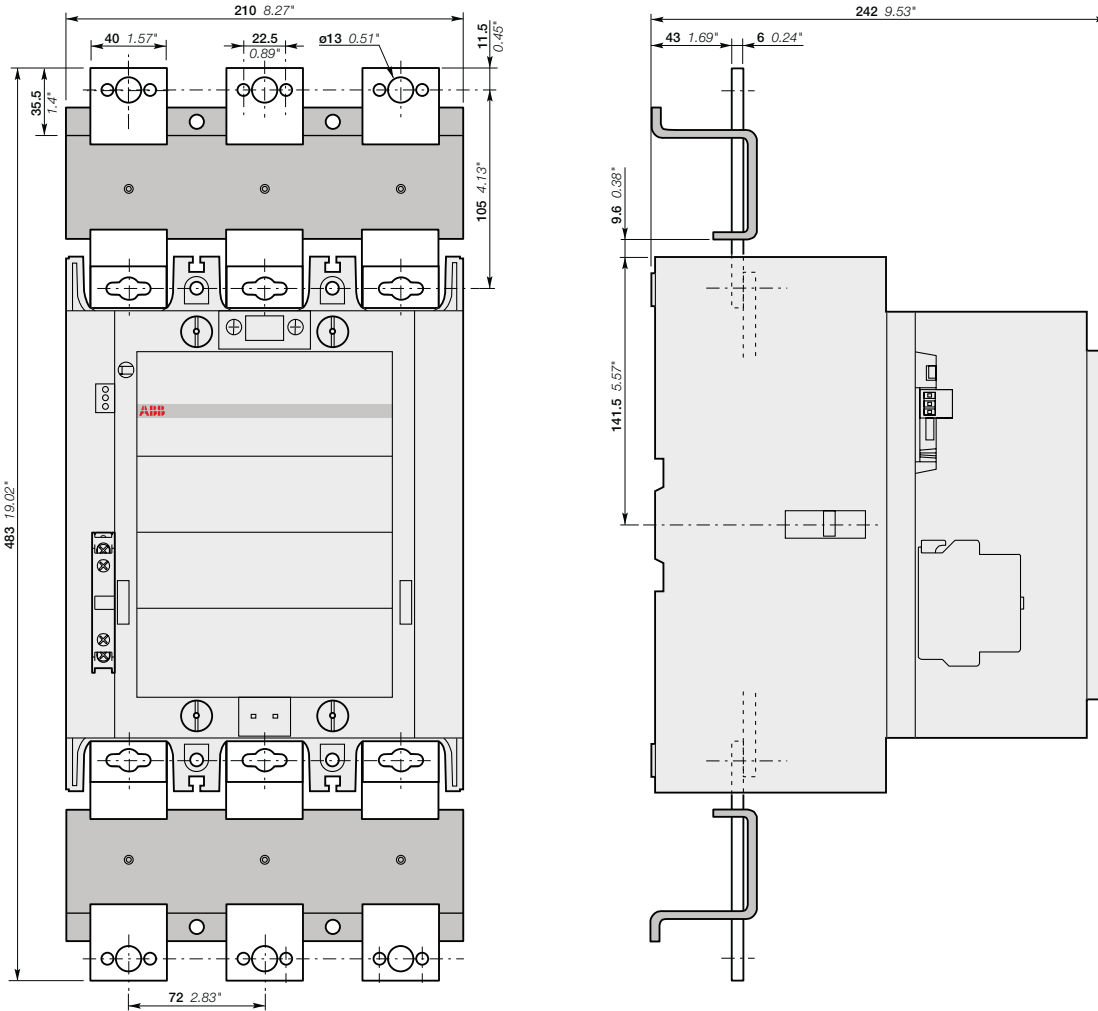

AF580 and AF750-30-11
+ LX750 terminal extension

AF580 and AF750 3-pole contactors

Main dimensions mm, inches

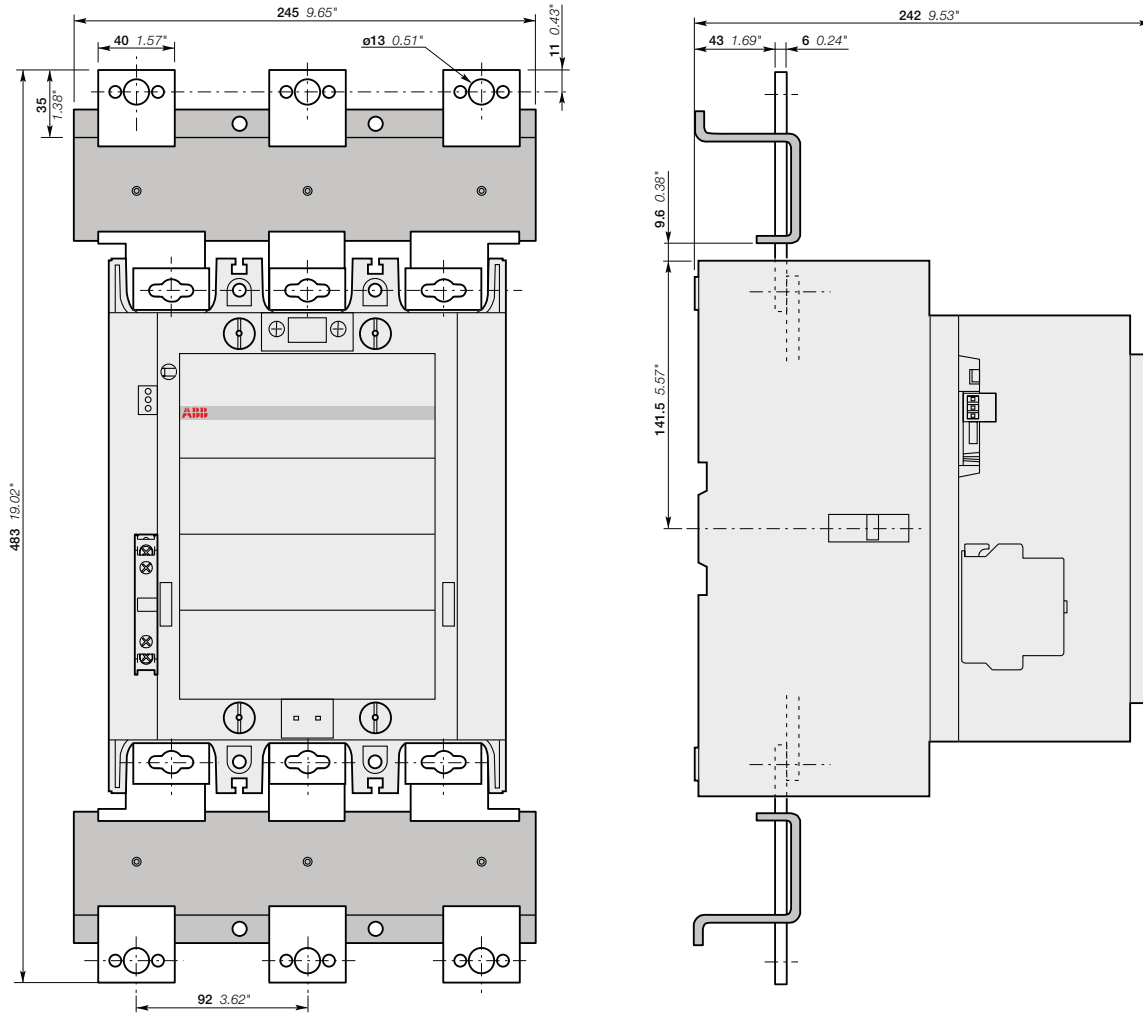

AF580 and AF750-30-11
+ LW750 terminal enlargement

AF580 and AF750 3-pole contactors

Main dimensions mm, inches

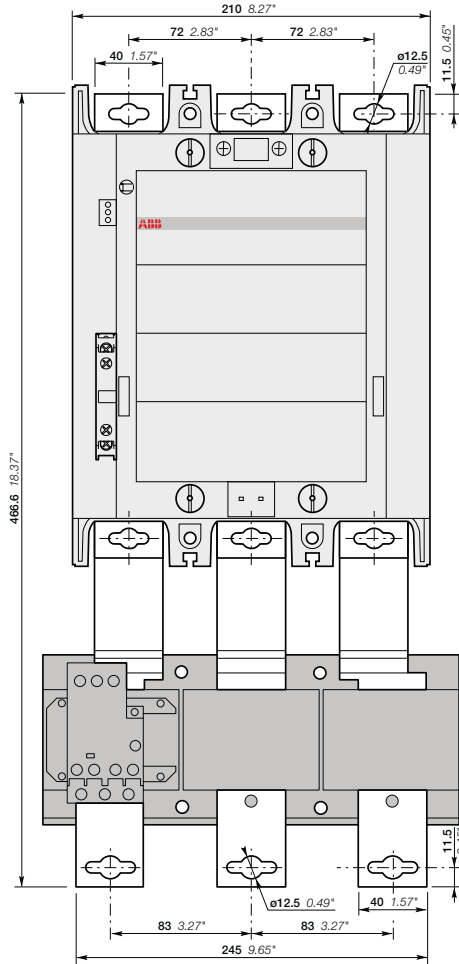

AF580 and AF750-30-11
+ E800DU electronic O/L relay

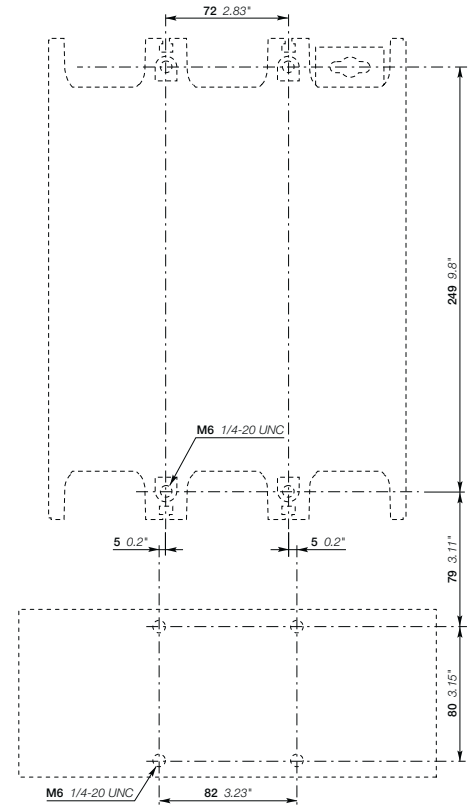
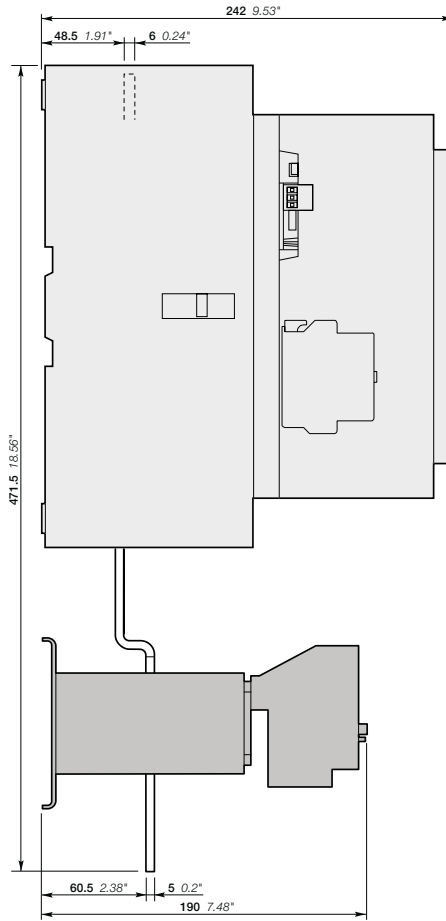

AF580 and AF750
+ E800DU electronic O/L relay

AF580 and AF750 3-pole contactors

Main dimensions mm, inches

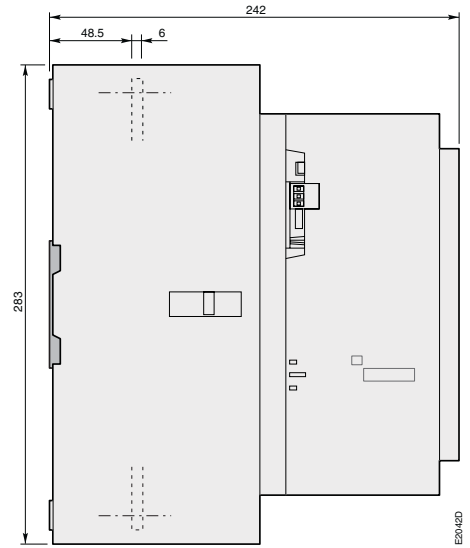
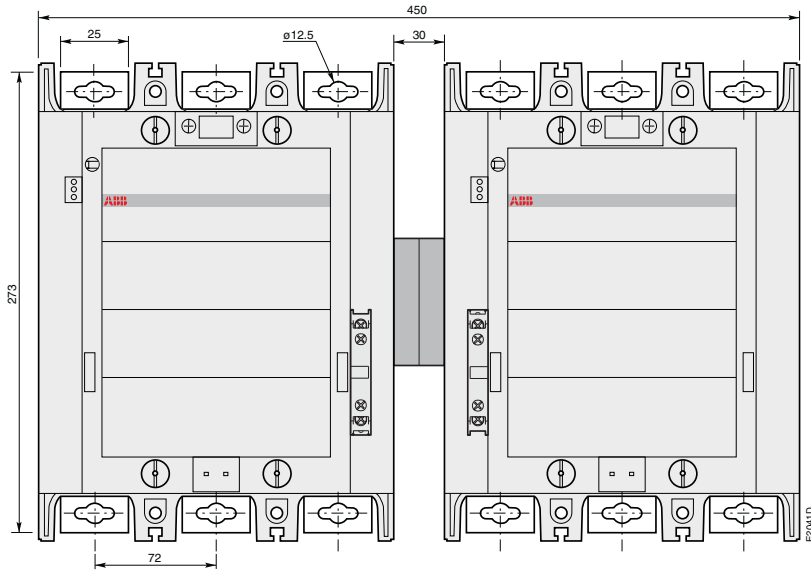

AF580 and AF750-30-11
+ VM 750H mechanical interlock unit

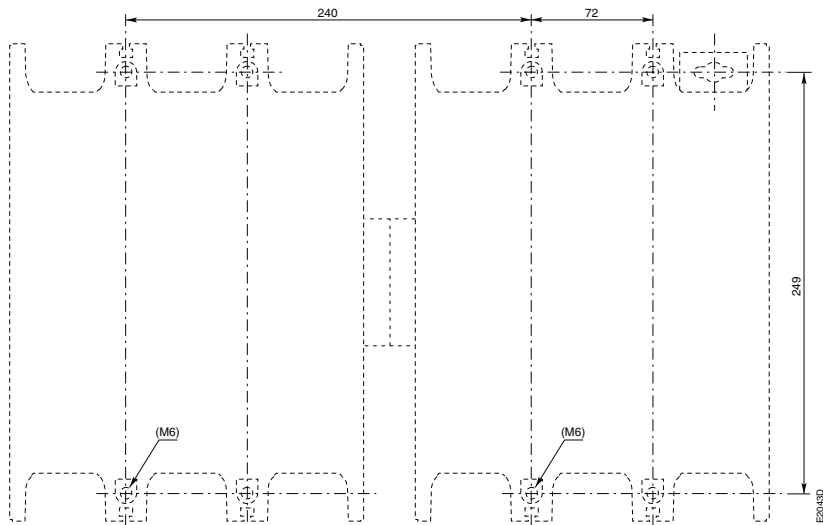

AF580 and AF750
+ VM 750H mechanical interlock unit

AF1250 3-pole contactors

Main dimensions mm, inches

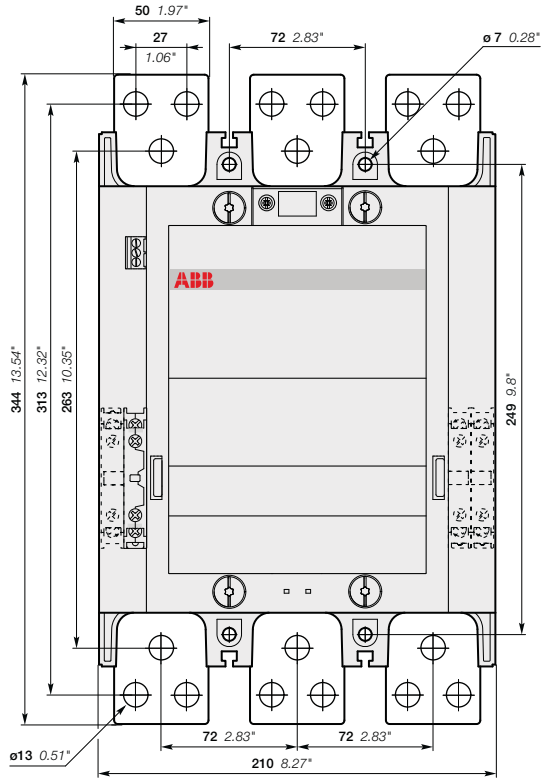

AF1250-30-11

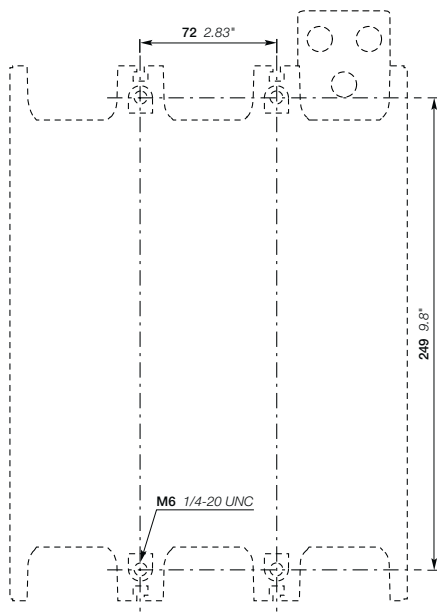
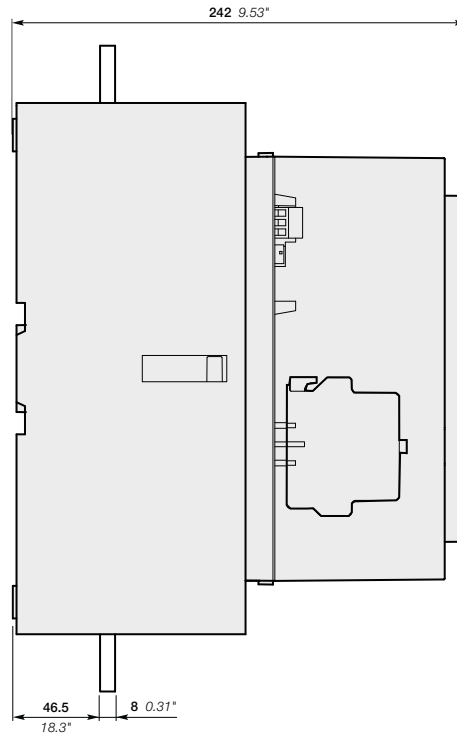

AF1250

AF1250 3-pole contactors

Main dimensions mm, inches

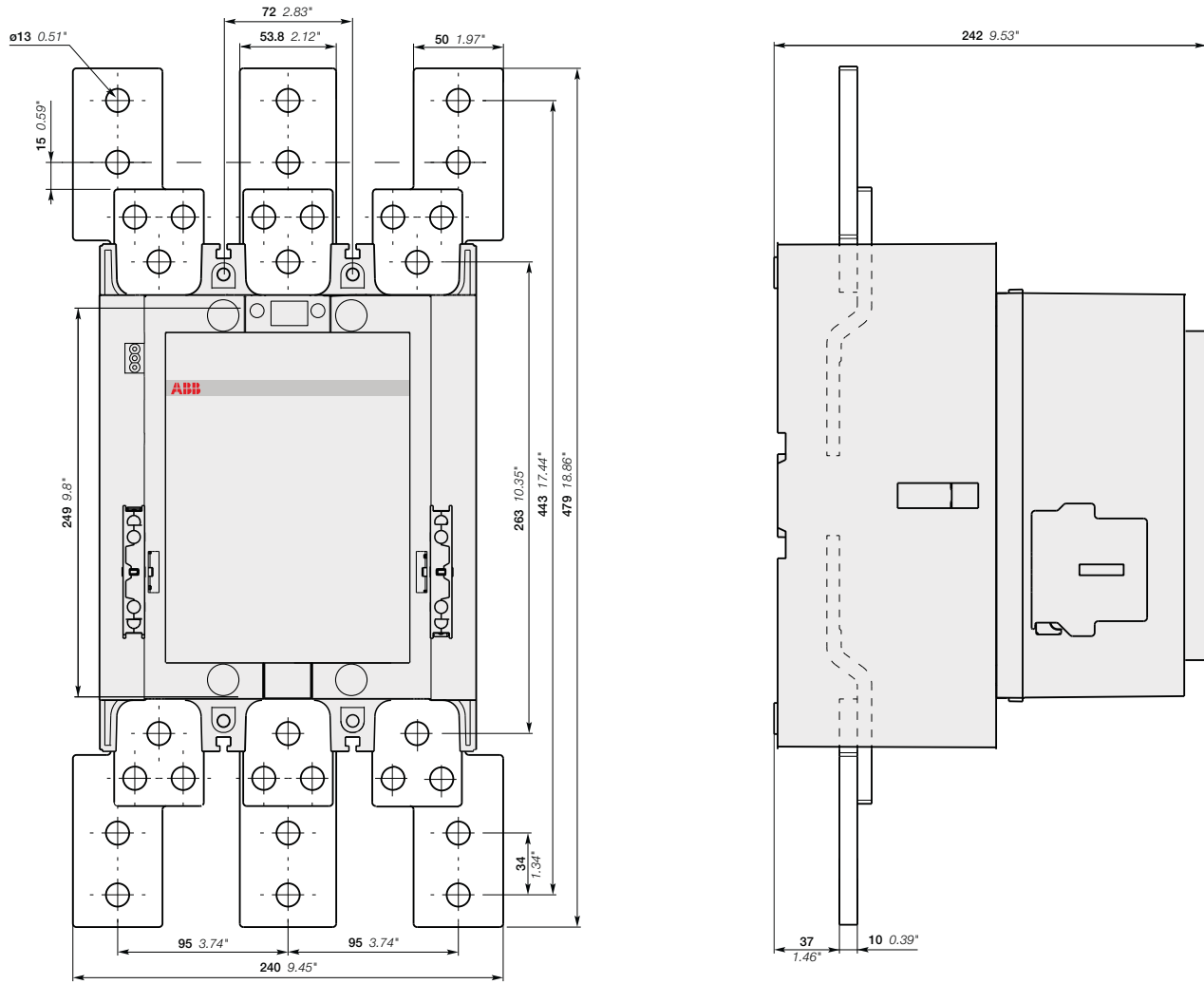

AF1250-30-11
+ LW1250 terminal enlargement

AF1350, AF1650, AF2050 and AF2650 3-pole contactors

Main dimensions mm, inches

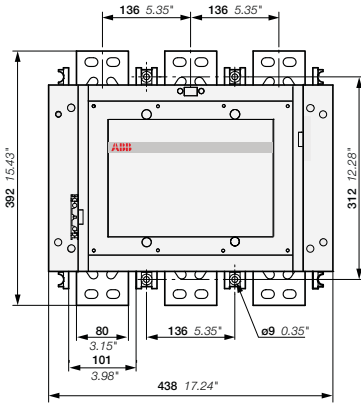
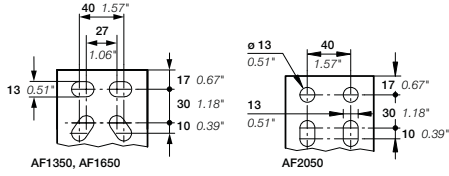

AF1350, AF1650, AF2050-30-11

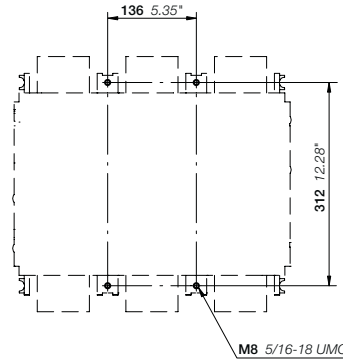
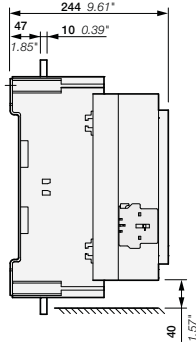

AF1350, AF1650, AF2050

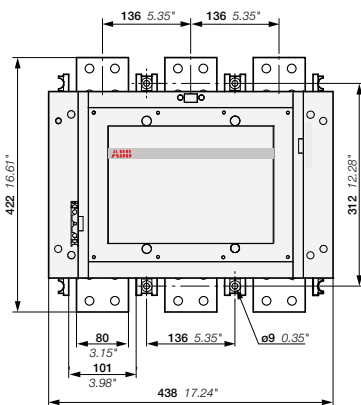
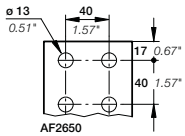

AF2650-30-11

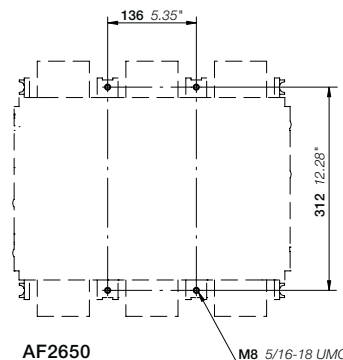
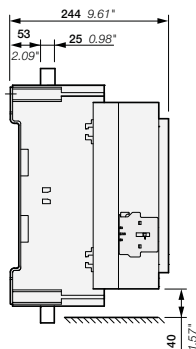

AF2650

AF1350, AF1650, AF2050 and AF2650 3-pole contactors

Main dimensions mm, inches

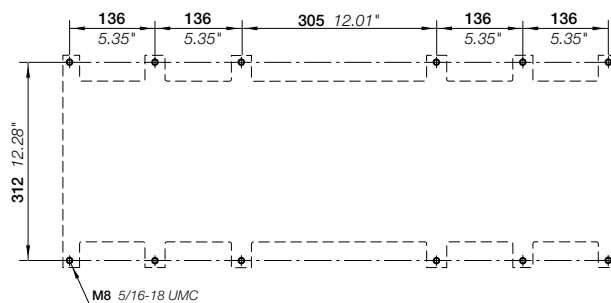
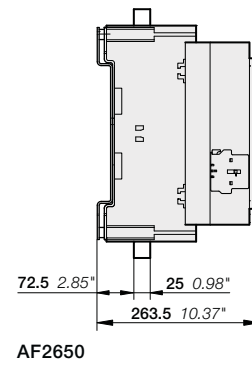
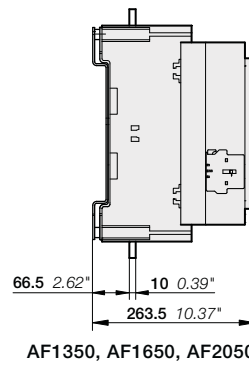
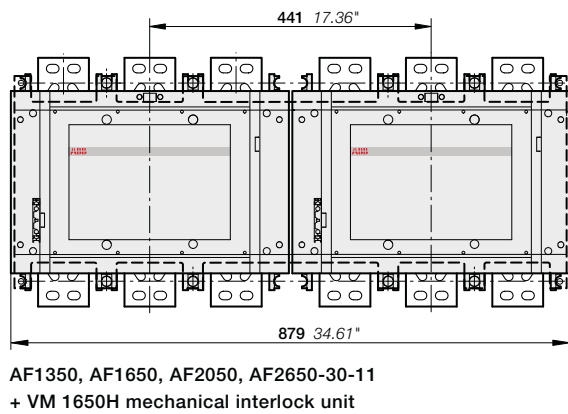
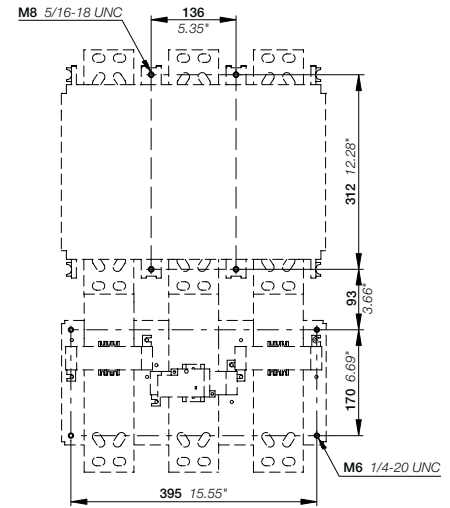
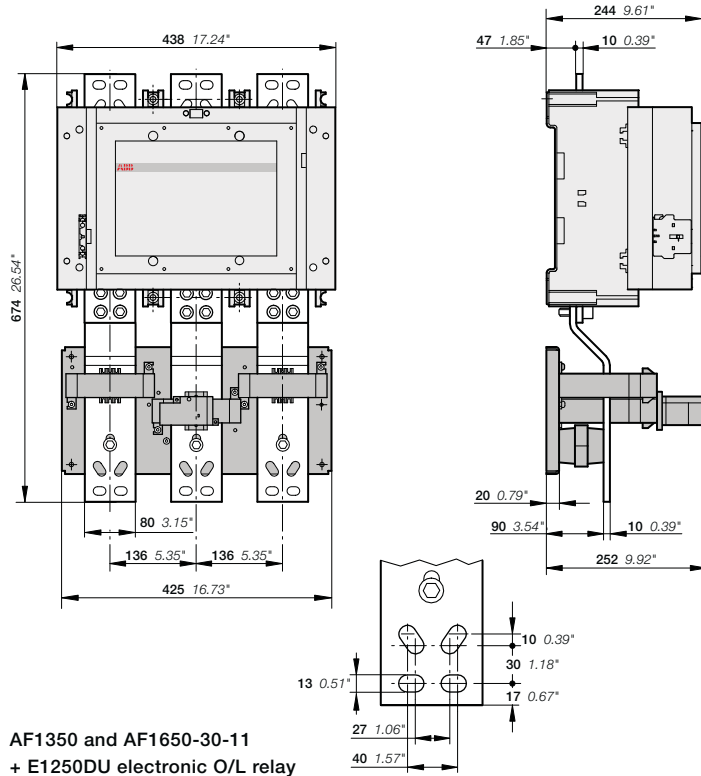



AF and EK 4-pole contactors

[Overview](#) 5/188

Ordering details

25 to 125 A AC-1

AF09 ... AF38	AC / DC operated	5/190
AF09Z ... AF38Z	AC / DC operated - low consumption	5/191
AF40 ... AF80	AC / DC operated	5/192
Main accessories		5/194

160 to 525 A AC-1

AF116 ... AF140	AC / DC operated	5/196
AF190 ... AF370	AC / DC operated	5/197
Main accessories		5/198
AF116 ... AF140	AC / DC operated - with 1 N.O. + 1 N.C.	5/200
AF190 ... AF370	AC / DC operated - with 1 N.O. + 1 N.C.	5/201
Main accessories		5/202
AF116 ... AF140	AC / DC operated - with 2 N.O. + 2 N.C.	5/204
AF190 ... AF370	AC / DC operated - with 2 N.O. + 2 N.C.	5/205
Main accessories		5/206

800 to 1000 A AC-1

EK550, EK1000	AC operated - with 1 N.O. + 1 N.C.	5/208
EK550, EK1000	DC operated - with 2 N.O. + 1 N.C.	5/209
EK550, EK1000	AC operated - with 2 N.O. + 2 N.C.	5/210
Main accessories		5/212

[Technical data](#) 5/214

[Electrical durability](#) 5/226

[Terminal marking and positioning](#) 5/228

[Main dimensions](#) 5/231

[Voltage code table](#) 5/410

4-pole contactors



IEC	AC-1 Rated operational current	$\theta \leq 40\text{ }^\circ\text{C}$, 690 V	A	25	30	45	55	70	100	125	
UL/CSA	General use rating	600 V	A	25	30	45	55	60	80	105	
AC / DC Control supply			Type	AF09	AF16	AF26	AF38	AF40	AF52	AF80	
AC Control supply			Type	AF09	AF16	AF26	AF38	AF40	AF52	AF80	
DC Control supply			Type	AF09	AF16	AF26	AF38	AF40	AF52	AF80	
IEC	AC-1 Rated operational current	$\theta \leq 40\text{ }^\circ\text{C}$	A	25	30	45	55	70	100	125	
		690 V	$\theta \leq 60\text{ }^\circ\text{C}$ (1)	A	25	30	40	45	60	80	105
			$\theta \leq 70\text{ }^\circ\text{C}$	A	22	26	32	37	50	70	90
		With conductor cross sectional area		mm ²	4	6	10	16	35	35	50
	Rated operational voltage Ue max.		V	690	690	690	690	690	690	690	

(1) $\theta \leq 55\text{ }^\circ\text{C}$ for EK550, EK1000 contactors

Main accessories

Auxiliary contact blocks	Front mounting	CA4-10 (1 x N.O.), CA4-01 (1 x N.C.)
	Side mounting	
Timers	Electronic	TEF4-ON
		TEF4-OFF
Interlocking units	Mechanical	VM4
	Mechanical / Electrical	
Surge suppressors	Varistor + RC (AC / DC)	Built-in surge protection



160	200	275	350	400	500	525	800	1000
160	175	230	250	300	350	420	540	—
AF116	AF140	AF190	AF205	AF265	AF305	AF370	—	—
AF116	AF140	AF190	AF205	AF265	AF305	AF370	EK550	EK1000
AF116	AF140	AF190	AF205	AF265	AF305	AF370	EK550	EK1000
160	200	275	350	400	500	525	800	1000
145	175	250	300	350	400	425	650	800
130	160	200	240	290	325	350	575	720
70	95	150	240	240	300	2 x 185	2 x 240	2 x 300
690	690	1000	1000	1000	1000	1000	1000	1000

CAL19-11 (1 x N.O. + 1 x N.C.)	CAL16-11 (1 x N.O. + 1 x N.C.)
VM19 (for same size contactors)	VH800
	RC-EH800

AF09 ... AF38 4-pole contactors

25 to 55 A AC-1

AC / DC operated



AF09-40-00

1SBC101097F0014

Description

AF09 ... AF38 4-pole contactors are mainly used for controlling non-inductive or slightly inductive loads (i.e. resistance furnaces...) and generally for controlling power circuits up to 690 V AC and 440 V DC. These contactors are of the block type design with 4 main poles.

- control circuit: AC or DC operated with electronic coil interface accepting a wide control voltage range (e.g. 100...250 V AC and DC), only 4 control voltage ranges covering 24...500 V 50/60 Hz and 20...500 V DC
- can manage large control voltage variations
- reduced panel energy consumption
- very distinct closing and opening.
- built-in surge suppression
- add-on auxiliary contact blocks for front or side mounting and a wide range of accessories.

Ordering details

IEC Rated operational current $\theta \leq 40^\circ\text{C}$ AC-1	UL/CSA General use rating 600 V AC	Rated control circuit voltage Uc min. ... Uc max.		Auxiliary contacts fitted		Type	Order code	Weight Pkg (1 pce)	
A	A	V 50/60 Hz	V DC					kg	
4 N.O. main poles									
25	25	24...60	-	(1)	0	0	AF09-40-00-41	1SBL137201R4100	0.270
		48...130	48...130	0	0	0	AF09-40-00-12	1SBL137201R1200	0.270
		100...250	100...250	0	0	0	AF09-40-00-13	1SBL137201R1300	0.270
		250...500	250...500	0	0	0	AF09-40-00-14	1SBL137201R1400	0.310
30	30	24...60	-	(1)	0	0	AF16-40-00-41	1SBL177201R4100	0.270
		48...130	48...130	0	0	0	AF16-40-00-12	1SBL177201R1200	0.270
		100...250	100...250	0	0	0	AF16-40-00-13	1SBL177201R1300	0.270
		250...500	250...500	0	0	0	AF16-40-00-14	1SBL177201R1400	0.310
45	45	24...60	-	(1)	0	0	AF26-40-00-41	1SBL237201R4100	0.360
		48...130	48...130	0	0	0	AF26-40-00-12	1SBL237201R1200	0.360
		100...250	100...250	0	0	0	AF26-40-00-13	1SBL237201R1300	0.360
		250...500	250...500	0	0	0	AF26-40-00-14	1SBL237201R1400	0.400
55	55	24...60	-	(1)	0	0	AF38-40-00-41	1SBL297201R4100	0.360
		48...130	48...130	0	0	0	AF38-40-00-12	1SBL297201R1200	0.360
		100...250	100...250	0	0	0	AF38-40-00-13	1SBL297201R1300	0.360
		250...500	250...500	0	0	0	AF38-40-00-14	1SBL297201R1400	0.400
2 N.O. + 2 N.C. main poles									
25	25	24...60	-	(1)	0	0	AF09-22-00-41	1SBL137501R4100	0.270
		48...130	48...130	0	0	0	AF09-22-00-12	1SBL137501R1200	0.270
		100...250	100...250	0	0	0	AF09-22-00-13	1SBL137501R1300	0.270
		250...500	250...500	0	0	0	AF09-22-00-14	1SBL137501R1400	0.310
30	30	24...60	-	(1)	0	0	AF16-22-00-41	1SBL177501R4100	0.270
		48...130	48...130	0	0	0	AF16-22-00-12	1SBL177501R1200	0.270
		100...250	100...250	0	0	0	AF16-22-00-13	1SBL177501R1300	0.270
		250...500	250...500	0	0	0	AF16-22-00-14	1SBL177501R1400	0.310
45	45	24...60	-	(1)	0	0	AF26-22-00-41	1SBL237501R4100	0.360
		48...130	48...130	0	0	0	AF26-22-00-12	1SBL237501R1200	0.360
		100...250	100...250	0	0	0	AF26-22-00-13	1SBL237501R1300	0.360
		250...500	250...500	0	0	0	AF26-22-00-14	1SBL237501R1400	0.400
55	55	24...60	-	(1)	0	0	AF38-22-00-41	1SBL297501R4100	0.360
		48...130	48...130	0	0	0	AF38-22-00-12	1SBL297501R1200	0.360
		100...250	100...250	0	0	0	AF38-22-00-13	1SBL297501R1300	0.360
		250...500	250...500	0	0	0	AF38-22-00-14	1SBL297501R1400	0.400

(1) For 24...60 V 50/60 Hz - 20...60 V DC, use AF..Z...00-21.

Main dimensions mm, inches

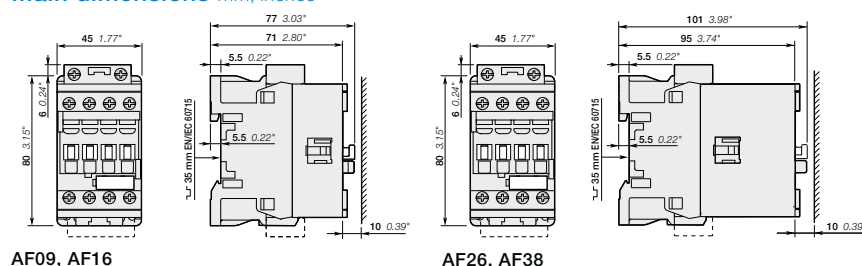

AF09, AF16

AF26, AF38

AF09Z ... AF38Z 4-pole contactors

25 to 55 A AC-1

AC / DC operated - low consumption



AF09Z-40-00





AF26Z-40-00

Description

AF09Z ... AF38Z 4-pole contactors are mainly used for controlling non-inductive or slightly inductive loads (i.e. resistance furnaces...) and generally for controlling power circuits up to 690 V AC and 440 V DC. These contactors are of the block type design with 4 main poles.

- control circuit: AC or DC operated with electronic coil interface accepting a wide control voltage range (e.g. 100...250 V AC and DC), only 4 control voltage ranges covering 24...250 V 50/60 Hz and 12...250 V DC
- can manage large control voltage variations
- allow direct control by PLC-output ≥ 24 V DC 500 mA
- reduced panel energy consumption
- very distinct closing and opening
- can withstand short voltage dips and voltage sags (SEMI F47-0706 conditions of use on request).
- built-in surge suppression
- add-on auxiliary contact blocks for front or side mounting and a wide range of accessories.

Ordering details

IEC	UL/CSA	Rated control circuit voltage		Auxiliary contacts fitted	Type	Order code	Weight
Rated operational current $\theta \leq 40$ °C AC-1	General use rating 600 V AC	Uc min. ...	Uc max.				Pkg (1 pce)
A	A	V 50/60 Hz	V DC	 			kg

4 N.O. main poles

Rated current	General use rating	Uc min. (V 50/60 Hz)	Uc max. (V DC)	Auxiliary contacts	Type	Order code	Weight
25	25	-	12...20	0 0	AF09Z-40-00-20	1SBL136201R2000	0.310
		24...60	20...60	0 0	AF09Z-40-00-21	1SBL136201R2100	0.310
		48...130	48...130	0 0	AF09Z-40-00-22	1SBL136201R2200	0.310
		100...250	100...250	0 0	AF09Z-40-00-23	1SBL136201R2300	0.310
30	30	-	12...20	0 0	AF16Z-40-00-20	1SBL176201R2000	0.310
		24...60	20...60	0 0	AF16Z-40-00-21	1SBL176201R2100	0.310
		48...130	48...130	0 0	AF16Z-40-00-22	1SBL176201R2200	0.310
		100...250	100...250	0 0	AF16Z-40-00-23	1SBL176201R2300	0.310
45	45	-	12...20	0 0	AF26Z-40-00-20	1SBL236201R2000	0.400
		24...60	20...60	0 0	AF26Z-40-00-21	1SBL236201R2100	0.400
		48...130	48...130	0 0	AF26Z-40-00-22	1SBL236201R2200	0.400
		100...250	100...250	0 0	AF26Z-40-00-23	1SBL236201R2300	0.400
55	55	-	12...20	0 0	AF38Z-40-00-20	1SBL296201R2000	0.400
		24...60	20...60	0 0	AF38Z-40-00-21	1SBL296201R2100	0.400
		48...130	48...130	0 0	AF38Z-40-00-22	1SBL296201R2200	0.400
		100...250	100...250	0 0	AF38Z-40-00-23	1SBL296201R2300	0.400

2 N.O. + 2 N.C. main poles

Rated current	General use rating	Uc min. (V 50/60 Hz)	Uc max. (V DC)	Auxiliary contacts	Type	Order code	Weight
25	25	-	12...20	0 0	AF09Z-22-00-20	1SBL136501R2000	0.310
		24...60	20...60	0 0	AF09Z-22-00-21	1SBL136501R2100	0.310
		48...130	48...130	0 0	AF09Z-22-00-22	1SBL136501R2200	0.310
		100...250	100...250	0 0	AF09Z-22-00-23	1SBL136501R2300	0.310
30	30	-	12...20	0 0	AF16Z-22-00-20	1SBL176501R2000	0.310
		24...60	20...60	0 0	AF16Z-22-00-21	1SBL176501R2100	0.310
		48...130	48...130	0 0	AF16Z-22-00-22	1SBL176501R2200	0.310
		100...250	100...250	0 0	AF16Z-22-00-23	1SBL176501R2300	0.310
45	45	-	12...20	0 0	AF26Z-22-00-20	1SBL236501R2000	0.400
		24...60	20...60	0 0	AF26Z-22-00-21	1SBL236501R2100	0.400
		48...130	48...130	0 0	AF26Z-22-00-22	1SBL236501R2200	0.400
		100...250	100...250	0 0	AF26Z-22-00-23	1SBL236501R2300	0.400
55	55	-	12...20	0 0	AF38Z-22-00-20	1SBL296501R2000	0.400
		24...60	20...60	0 0	AF38Z-22-00-21	1SBL296501R2100	0.400
		48...130	48...130	0 0	AF38Z-22-00-22	1SBL296501R2200	0.400
		100...250	100...250	0 0	AF38Z-22-00-23	1SBL296501R2300	0.400

Note: Only AF.Z contactors with DC control voltage 12...20 V DC need to respect the connection polarities indicated close to the coil terminals: A1+ for the positive pole and A2- for the negative pole.

Main dimensions mm, inches

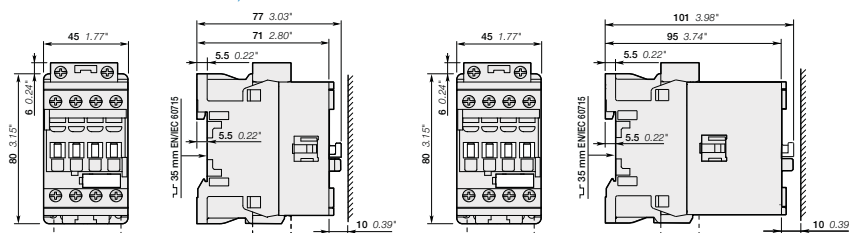

AF09Z, AF16Z

AF26Z, AF38Z

AF40 ... AF80 4-pole contactors

70 to 125 A AC-1

AC / DC operated



AF40-40-00



AF80-40-00

Description

AF40 ... AF80 4-pole contactors are mainly used for controlling non-inductive or slightly inductive loads (i.e. resistance furnaces...) and generally for controlling power circuits up to 690 V AC and 440 V DC. These contactors are of the block type design with 4 main poles.

- control circuit: AC or DC operated with electronic coil interface accepting a wide control voltage range (e.g. 100...250 V AC and DC), only 4 control voltages ranges covering 24...500 V 50/60 Hz and 20...500 V DC
- can manage large control voltage variations
- reduced panel energy consumption
- very distinct closing and opening.
- built-in surge suppression
- add-on auxiliary contact blocks for front or side mounting and a wide range of accessories.

Ordering details

IEC Rated operational current $\theta \leq 40^\circ\text{C}$ AC-1 A	UL/CSA General use rating 600 V AC A	Rated control circuit voltage Uc min. ... Uc max.		Auxiliary contacts fitted 	Type (1)	Order code	Weight Pkg (1 pce) kg
		V 50/60 Hz	V DC				
4 N.O. Main Poles							
70	60	24...60	-	0 0	AF40-40-00-41	1SBL347201R4100	1.210
		24...60	20...60 (1)	0 0	AF40-40-00-11	1SBL347201R1100	1.210
		48...130	48...130	0 0	AF40-40-00-12	1SBL347201R1200	1.210
		100...250	100...250	0 0	AF40-40-00-13	1SBL347201R1300	1.160
		250...500	250...500	0 0	AF40-40-00-14	1SBL347201R1400	1.160
100	80	24...60	-	0 0	AF52-40-00-41	1SBL367201R4100	1.210
		24...60	20...60 (1)	0 0	AF52-40-00-11	1SBL367201R1100	1.210
		48...130	48...130	0 0	AF52-40-00-12	1SBL367201R1200	1.210
		100...250	100...250	0 0	AF52-40-00-13	1SBL367201R1300	1.160
		250...500	250...500	0 0	AF52-40-00-14	1SBL367201R1400	1.160
125	105	24...60	-	0 0	AF80-40-00-41	1SBL397201R4100	1.490
		24...60	20...60 (1)	0 0	AF80-40-00-11	1SBL397201R1100	1.490
		48...130	48...130	0 0	AF80-40-00-12	1SBL397201R1200	1.490
		100...250	100...250	0 0	AF80-40-00-13	1SBL397201R1300	1.440
		250...500	250...500	0 0	AF80-40-00-14	1SBL397201R1400	1.440
2 N.O. + 2 N.C. Main Poles							
70	60	24...60	-	0 0	AF40-22-00-41	1SBL347501R4100	1.210
		24...60	20...60 (1)	0 0	AF40-22-00-11	1SBL347501R1100	1.210
		48...130	48...130	0 0	AF40-22-00-12	1SBL347501R1200	1.210
		100...250	100...250	0 0	AF40-22-00-13	1SBL347501R1300	1.160
		250...500	250...500	0 0	AF40-22-00-14	1SBL347501R1400	1.160
125	105	24...60	-	0 0	AF80-22-00-41	1SBL397501R4100	1.490
		24...60	20...60 (1)	0 0	AF80-22-00-11	1SBL397501R1100	1.490
		48...130	48...130	0 0	AF80-22-00-12	1SBL397501R1200	1.490
		100...250	100...250	0 0	AF80-22-00-13	1SBL397501R1300	1.440
		250...500	250...500	0 0	AF80-22-00-14	1SBL397501R1400	1.440

(1) AF.....-11 not suitable for direct control by PLC-output.

Main dimensions mm, inches

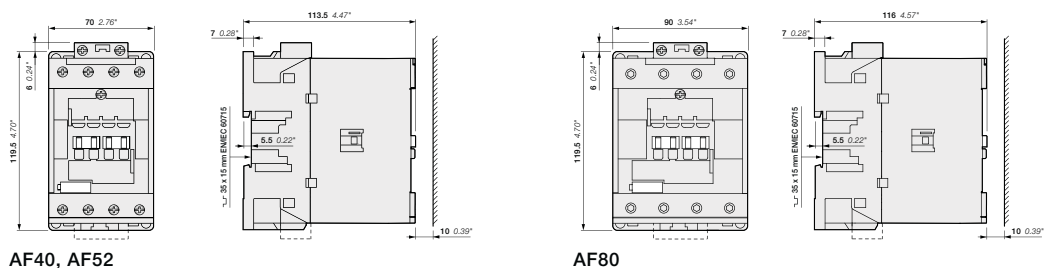

AF40, AF52

AF80

Notes

A series of horizontal dotted lines for taking notes, spanning most of the page width.

AF09 ... AF80 4-pole contactors

Main accessories

Contactor and main accessories (other accessories available)

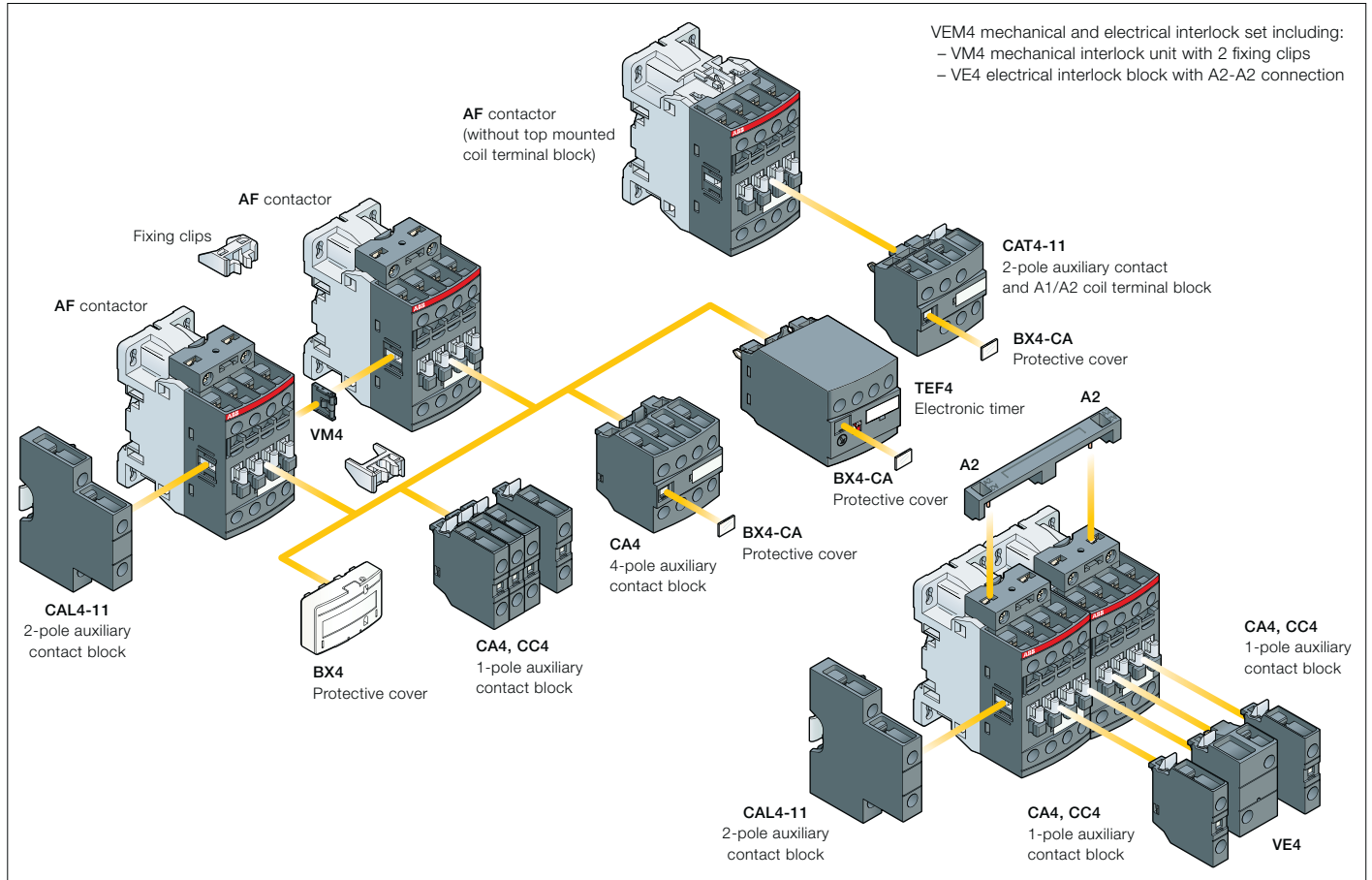

Main accessory fitting details

Many configurations of accessories are possible depending on whether these are front-mounted or side-mounted.

Contactor types	Main poles	Built-in auxiliary contacts	Front-mounted accessories				Electronic timer	Electrical and mechanical interlock set (between 2 contactors)	Side-mounted accessories	
			Auxiliary contact blocks			TEF4			VEM4	Left side
			1-pole CA4 1-pole CC4	2-pole CAT4-11	4-pole CA4			2-pole CAL4-11		
Max. add-on N.C. auxiliary contacts: 4 N.C. max. on positions 1, 2, 3, 4 and 3 N.C. max. on positions 1 ±30°, 5										
AF09 ... AF16	4	0	0	0	4 max. or 1	or 1	or 1	-	+ 1	-
					2 max. or 1	-	or 1	-	+ 1	+ 1
					3 max. -	-	-	+ 1	+ 1	or 1
Max. add-on N.C. auxiliary contacts: 3 N.C. max. on positions 1, 2, 3, 4 and 2 N.C. max. on positions 1 ±30°, 5										
AF26 ... AF38	4	0	0	0	4 max. or 1	or 1	or 1	-	+ 1	-
					2 max. or 1	-	or 1	-	+ 1	+ 1
					3 max. -	-	-	+ 1	+ 1	or 1
Max. add-on N.C. auxiliary contacts: 6 N.C. max. on positions 1, 1 ±30°, 2, 3, 4, 5										
AF40 ... AF52	4	0	0	0	4 max. or 1	or 1	or 1	-	+ 1	+ 1
AF80	4	0	0	0	4 max. -	or 1	or 1	-	+ 1	+ 1
Max. add-on N.C. auxiliary contacts: 3 N.C. max. on positions 1, 2, 3, 4 and 2 N.C. max. on positions 1 ±30°, 5										
AF09 ... AF16	2	2	0	0	4 max. or 1	or 1	or 1	-	+ 1	-
AF26 ... AF38	2	2	0	0	2 max. or 1	-	or 1	-	+ 1	+ 1
Max. add-on N.C. auxiliary contacts: 2 N.C. max. on positions 1, 1 ±30°, 2, 3, 4, 5										
AF40	2	2	0	0	4 max. or 1	or 1	or 1	-	+ 1	-
	2	2	0	0	4 max. -	or 1	or 1	-	+ 1	+ 1
AF80	2	2	0	0	4 max. -	or 1	or 1	-	+ 1	+ 1

AF09 ... AF80 4-pole contactors

Main accessories



CA4-10



CAL4-11



CA4-22E



CAT4-11E



VEM4

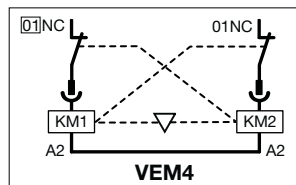

TEF4-ON

Ordering details (1)

For contactors	Auxiliary contacts	Type	Order code	Pkg qty	Weight (1 pce)
					kg

Front-mounted instantaneous auxiliary contact blocks

AF09 ... AF80-40-00	1 0	- -	CA4-10	1SBN010110R1010	1	0.014
AF09 ... AF80-22-00	1 0	- -	CA4-10-T	1SBN010110T1010	10	0.014
	0 1	- -	CA4-01	1SBN010110R1001	1	0.014
	0 1	- -	CA4-01-T	1SBN010110T1001	10	0.014
	2 2	- -	CA4-22E	1SBN010140R1022	1	0.055
	3 1	- -	CA4-31E	1SBN010140R1031	1	0.055
	4 0	- -	CA4-40E	1SBN010140R1040	1	0.055
AF09 ... AF16...-40-00	0 4	- -	CA4-04E	1SBN010140R1004	1	0.055
AF40 ... AF80-40-00						

Front-mounted auxiliary contact blocks with N.O. leading contact and N.C. lagging contact

AF09 ... AF80-40-00	- -	1 0	CC4-10	1SBN010111R1010	1	0.014
AF09 ... AF80-22-00	- -	0 1	CC4-01	1SBN010111R1001	1	0.014

Side-mounted instantaneous auxiliary contact blocks

AF09 ... AF80-40-00	1 1	- -	CAL4-11	1SBN010120R1011	1	0.040
AF09 ... AF80-22-00	1 1	- -	CAL4-11-T	1SBN010120T1011	10	0.040

Front-mounted instantaneous auxiliary contact and A1/A2 coil terminal blocks

AF09 ... AF52...-40-00	1 1	- -	CAT4-11E	1SBN010151R1011	1	0.040
AF09 ... AF40...-22-00						

Note: CAT4 not suitable for AF..Z contactors with DC control voltage 12...20 V DC.

Mechanical interlock unit

AF09 ... AF38...-40-00			VM4	1SBN030105T1000	10	0.005
AF40 ... AF80...-40-00			VM96-4	1SBN033405T1000	10	0.006

Note: VM4 includes 2 fixing clips (BB4) to maintain together both contactors.

Mechanical and electrical interlock set

AF09, AF16...-40-00	0 2	- -	VEM4	1SBN030111R1000	1	0.035
AF26, AF38...-40-00						

Note: - VEM4 includes a VM4 mechanical interlock unit with 2 fixing clips (BB4), a VE4 electrical interlock block. VE4 block must be used with A2-A2 connection to respect the electrical connection diagram.

- VEM4 not suitable for AF..Z contactors with DC control voltage 12...20 V DC.

For contactors	Time delay range selected by switch	Delay type	Auxiliary contacts	Type	Order code	Pkg qty	Weight (1 pce)
							kg

Electronic timers

AF09 ... AF80	0.1...1 s	ON-delay	1 1	TEF4-ON	1SBN020112R1000	1	0.065
	1...10 s						
	10...100 s	OFF-delay	1 1	TEF4-OFF	1SBN020114R1000	1	0.065

Note: Rated control circuit voltage U_c 24...240 V 50/60 Hz or DC.

(1) For more information, refer to main catalog "Accessories" section.

AF116 ... AF140 4-pole contactors

160 to 200 A AC-1

AC / DC operated



AF140-40-00

1SFC101198V0001



AF140-40-00B

1SFC101198V0001

Description

AF116 ... AF140 4-pole contactors are mainly used for controlling non-inductive or slightly inductive loads (i.e. resistance furnaces...) and generally for controlling power circuits up to 690 V AC and 350 V DC. These contactors are of the block type design with 4 main poles.

- control circuit: AC or DC operated with electronic coil interface accepting a wide control voltage range (e.g. 100...250 V AC and DC), only 4 coils to cover control voltages between 24...500 V 50/60 Hz and 20...500 V DC
- can manage large control voltage variations
- reduced panel energy consumption
- very distinct closing and opening
- can withstand short voltage dips and voltage sags (SEMI F47 conditions of use on request).
- built-in surge suppression
- add-on auxiliary contact blocks for side mounting and a wide range of accessories.

Ordering details

IEC Rated operational current $\theta \leq 40^\circ\text{C}$ AC-1 A	UL / CSA General use rating 600 V AC A	Rated control circuit voltage Uc min. ... Uc max. V 50/60 Hz V DC		Auxiliary contacts fitted 	Type (1)	Order code	Weight Pkg (1 pce) kg
--	--	--	--	-------------------------------------	-------------	------------	--------------------------------

4 N.O. main poles

For connection with built-in cable clamps

Rated current (A)	UL/CSA rating (A)	Uc min. (V)	Uc max. (V)	Auxiliary contacts (N.O.)	Type	Order code	Weight (kg)
160	160	24...60	20...60	0 0	AF116-40-00-11	1SFL427101R1100	2.250
		48...130	48...130	0 0	AF116-40-00-12	1SFL427101R1200	2.250
		100...250	100...250	0 0	AF116-40-00-13	1SFL427101R1300	2.250
		250...500	250...500	0 0	AF116-40-00-14	1SFL427101R1400	2.250
200	175	24...60	20...60	0 0	AF140-40-00-11	1SFL447101R1100	2.250
		48...130	48...130	0 0	AF140-40-00-12	1SFL447101R1200	2.250
		100...250	100...250	0 0	AF140-40-00-13	1SFL447101R1300	2.250
		250...500	250...500	0 0	AF140-40-00-14	1SFL447101R1400	2.250

With bar connections

Rated current (A)	UL/CSA rating (A)	Uc min. (V)	Uc max. (V)	Auxiliary contacts (N.O.)	Type	Order code	Weight (kg)
160	160	24...60	20...60	0 0	AF116-40-00B-11	1SFL427102R1100	2.150
		48...130	48...130	0 0	AF116-40-00B-12	1SFL427102R1200	2.150
		100...250	100...250	0 0	AF116-40-00B-13	1SFL427102R1300	2.150
		250...500	250...500	0 0	AF116-40-00B-14	1SFL427102R1400	2.150
200	175	24...60	20...60	0 0	AF140-40-00B-11	1SFL447102R1100	2.150
		48...130	48...130	0 0	AF140-40-00B-12	1SFL447102R1200	2.150
		100...250	100...250	0 0	AF140-40-00B-13	1SFL447102R1300	2.150
		250...500	250...500	0 0	AF140-40-00B-14	1SFL447102R1400	2.150

(1) For other auxiliary contacts arrangements, please contact your ABB local organization.

Main dimensions mm, inches

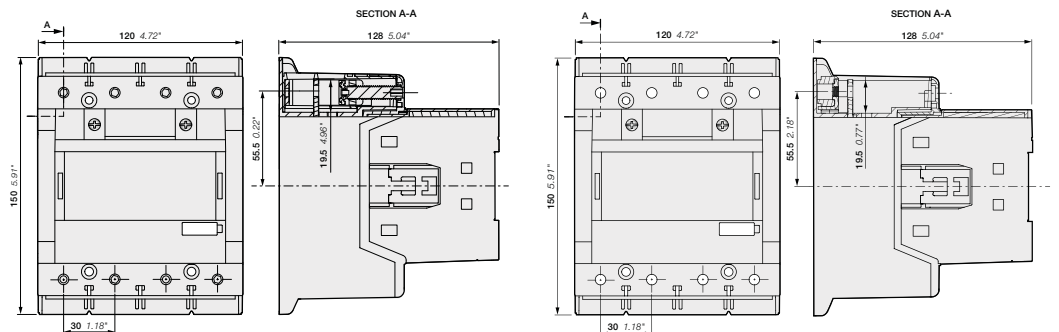

AF116, AF140-40-00

AF116, AF140-40-00B

1SFC101197C0201 - Rev. B

AF190 ... AF370 4-pole contactors

275 to 525 A AC-1

AC / DC operated



AF205-40-00

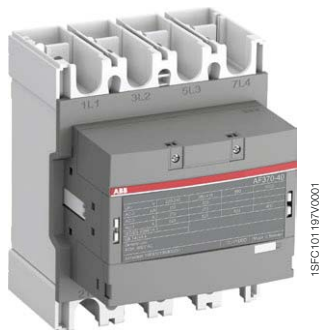

AF370-40-00

Description

AF190 ... AF370 4-pole contactors are mainly used for controlling non-inductive or slightly inductive loads (i.e. resistance furnaces...) and generally for controlling power circuits up to 1000 V AC and 440 V DC. These contactors are of the block type design with 4 main poles.

- control circuit: AC or DC operated with electronic coil interface accepting a wide control voltage range (e.g. 100...250 V AC and DC), only 4 coils to cover control voltages between 24...500 V 50/60 Hz and 20...500 V DC
- can manage large control voltage variations
- reduced panel energy consumption
- very distinct closing and opening
- can withstand short voltage dips and voltage sags (SEMI F47 conditions of use on request).
- built-in surge suppression
- add-on auxiliary contact blocks for side mounting and a wide range of accessories.

Ordering details

IEC	UL / CSA	Rated control circuit voltage		Auxiliary contacts fitted	Type (1)	Order code	Weight
Rated operational current $\theta \leq 40^\circ\text{C}$ AC-1	General use rating 600 V AC	Uc min. ...	Uc max.				Pkg (1 pce)
A	A	V 50/60 Hz	V DC				kg
4 N.O. main poles							
275	230	24...60	20...60	0 0	AF190-40-00-11	1SFL487102R1100	3.900
		48...130	48...130	0 0	AF190-40-00-12	1SFL487102R1200	3.900
		100...250	100...250	0 0	AF190-40-00-13	1SFL487102R1300	3.900
		250...500	250...500	0 0	AF190-40-00-14	1SFL487102R1400	3.900
350	250	24...60	20...60	0 0	AF205-40-00-11	1SFL527102R1100	3.900
		48...130	48...130	0 0	AF205-40-00-12	1SFL527102R1200	3.900
		100...250	100...250	0 0	AF205-40-00-13	1SFL527102R1300	3.900
		250...500	250...500	0 0	AF205-40-00-14	1SFL527102R1400	3.900
400	300	24...60	20...60	0 0	AF265-40-00-11	1SFL547102R1100	6.360
		48...130	48...130	0 0	AF265-40-00-12	1SFL547102R1200	6.360
		100...250	100...250	0 0	AF265-40-00-13	1SFL547102R1300	6.360
		250...500	250...500	0 0	AF265-40-00-14	1SFL547102R1400	6.360
500	350	24...60	20...60	0 0	AF305-40-00-11	1SFL587102R1100	6.360
		48...130	48...130	0 0	AF305-40-00-12	1SFL587102R1200	6.360
		100...250	100...250	0 0	AF305-40-00-13	1SFL587102R1300	6.360
		250...500	250...500	0 0	AF305-40-00-14	1SFL587102R1400	6.360
525	420	24...60	20...60	0 0	AF370-40-00-11	1SFL607102R1100	6.360
		48...130	48...130	0 0	AF370-40-00-12	1SFL607102R1200	6.360
		100...250	100...250	0 0	AF370-40-00-13	1SFL607102R1300	6.360
		250...500	250...500	0 0	AF370-40-00-14	1SFL607102R1400	6.360

(1) For other auxiliary contacts arrangements, please contact your ABB local organization.

Main dimensions mm, inches

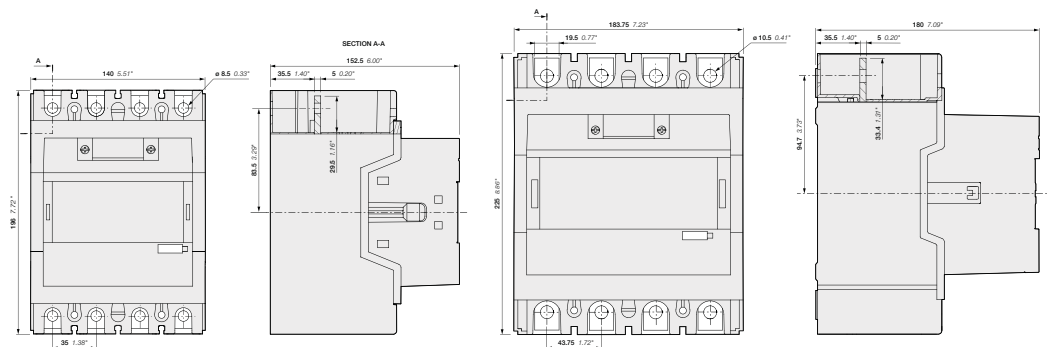

AF190, AF205

AF265, AF305, AF370

AF116 ... AF370 4-pole contactors

Main accessories

Main accessories (other accessories available)

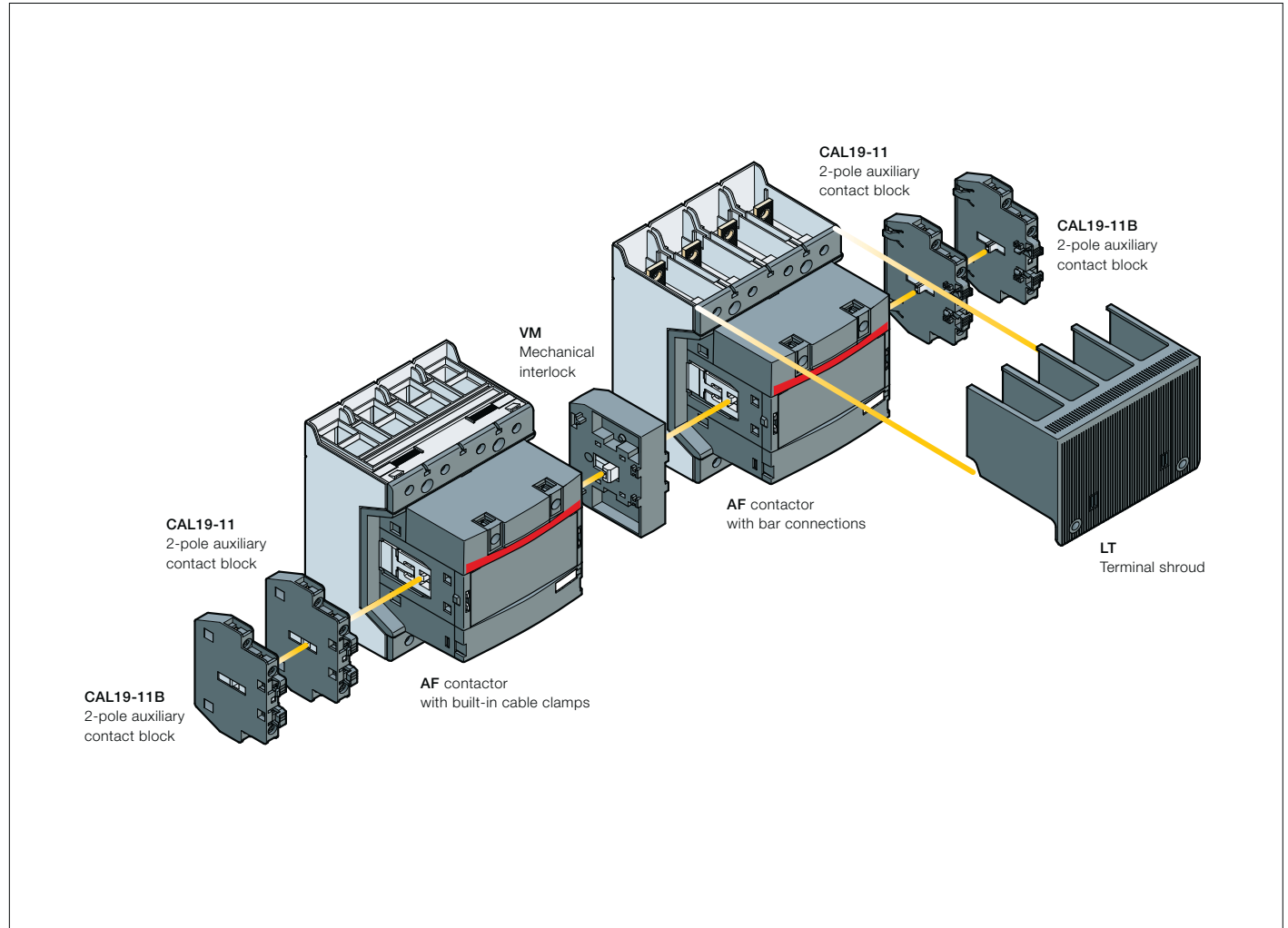

Main accessory fitting details

Contactor types	Main poles	Available auxiliary contacts	Side-mounted accessories		
			Auxiliary contact blocks		Mechanical interlock units (between two contactors)
			CAL19-11 (3)	CAL19-11B (3)	
AF116 ... AF370	4	0 0 0	2 x CAL19-11	+ 2 x CAL19-11B	-
AF116 ... AF370	4	0 0 0	2 x CAL19-11 (1)	+ 2 x CAL19-11B (1)	+ VM... (2)

(1) Total number of auxiliary contact blocks for the two contactors.

(2) Interlock type, according to the contactor ratings (see "Accessories").

(3) The CEL19 auxiliary contact blocks can replace the CAL19-11 and CAL19-11B. Though, no auxiliary contact block can be mounted outside the CEL19.

AF116 ... AF370 4-pole contactors

Main accessories



CAL19-11

1SFC101071V0001



VM19

1SFC101035W0001

Ordering details (1)

For contactors	Auxiliary contacts		Type	Order code	Pkg qty	Weight (1 pce)
	1	1				kg

Side-mounted instantaneous auxiliary contact blocks

AF116 ... AF370	1	1	CAL19-11	1SFN010820R1011	2	0.050
	1	1	CAL19-11B	1SFN010820R3311	2	0.050

Mechanical interlock unit

AF116 ... AF370			VM19	1SFN030300R1000	1	0.054
AF116 ... AF146 and AF190, AF205			VM140/190	1SFN034403R1000	1	0.088
AF190, AF205 and AF265 ... AF370			VM205/265	1SFN035203R1000	1	0.090

Terminal shrouds

AF116 ... AF140, with compression lugs			LT140-40L	1SFN124203R2000	2	0.090
AF190 ... AF205, with cable clamps			LT205-40C	1SFN124801R2000	2	0.060
AF190 ... AF205, with compression lugs			LT205-40L	1SFN124803R2000	2	0.290
AF265 ... AF370, with cable clamps			LT370-40C	1SFN125401R2000	2	0.040
AF265 ... AF370, with compression lugs			LT370-40L	1SFN125403R2000	2	0.370

5

For contactors	Dimensions		Type	Order code	Pkg qty	Weight (1 pce)
	hole Ø mm	bar mm				

Terminal enlargements

AF190 ... AF205	10.5	20 x 5	LW205-40	1SFN074807R2000	1	0.306
AF265 ... AF370	10.5	25 x 5	LW370-40	1SFN075407R2000	1	0.540

(1) For more information, refer to "Accessories" section.

AF116 ... AF140 4-pole contactors

160 to 200 A AC-1

AC / DC operated with 1 N.O. + 1 N.C. auxiliary contacts



AF140-40-11

1SFC101154V0001



AF140-40-11B

1SFC101192V0001

Description

AF116 ... AF140 4-pole contactors are mainly used for controlling non-inductive or slightly inductive loads (i.e. resistance furnaces...) and generally for controlling power circuits up to 690 V AC and 350 V DC. These contactors are of the block type design with 4 main poles.

- control circuit: AC or DC operated with electronic coil interface accepting a wide control voltage range (e.g. 100...250 V AC and DC), only 4 coils to cover control voltages between 24...500 V 50/60 Hz and 20...500 V DC
- can manage large control voltage variations
- reduced panel energy consumption
- very distinct closing and opening
- can withstand short voltage dips and voltage sags (SEMI F47 conditions of use on request).
- built-in surge suppression
- add-on auxiliary contact blocks for side mounting and a wide range of accessories.

Ordering details

IEC Rated operational current $\theta \leq 40^\circ\text{C}$ AC-1 A	UL / CSA General use rating 600 V AC A	Rated control circuit voltage Uc min. ... Uc max. V 50/60 Hz V DC		Auxiliary contacts fitted 	Type (1)	Order code	Weight Pkg (1 pce) kg
--	--	---	--	---	-------------	------------	--------------------------------

4 N.O. main poles

For connection with built-in cable clamps

Rated current (A)	UL/CSA rating (A)	Uc min. (V)	Uc max. (V)	N.O. (1)	N.C. (1)	Type	Order code	Weight (kg)
160	160	24...60	20...60	1	1	AF116-40-11-11	1SFL427101R1111	2.270
		48...130	48...130	1	1	AF116-40-11-12	1SFL427101R1211	2.270
		100...250	100...250	1	1	AF116-40-11-13	1SFL427101R1311	2.270
		250...500	250...500	1	1	AF116-40-11-14	1SFL427101R1411	2.270
200	175	24...60	20...60	1	1	AF140-40-11-11	1SFL447101R1111	2.270
		48...130	48...130	1	1	AF140-40-11-12	1SFL447101R1211	2.270
		100...250	100...250	1	1	AF140-40-11-13	1SFL447101R1311	2.270
		250...500	250...500	1	1	AF140-40-11-14	1SFL447101R1411	2.270

With bar connections

Rated current (A)	UL/CSA rating (A)	Uc min. (V)	Uc max. (V)	N.O. (1)	N.C. (1)	Type	Order code	Weight (kg)
160	160	24...60	20...60	1	1	AF116-40-11B-11	1SFL427102R1111	2.170
		48...130	48...130	1	1	AF116-40-11B-12	1SFL427102R1211	2.170
		100...250	100...250	1	1	AF116-40-11B-13	1SFL427102R1311	2.170
		250...500	250...500	1	1	AF116-40-11B-14	1SFL427102R1411	2.170
200	175	24...60	20...60	1	1	AF140-40-11B-11	1SFL447102R1111	2.170
		48...130	48...130	1	1	AF140-40-11B-12	1SFL447102R1211	2.170
		100...250	100...250	1	1	AF140-40-11B-13	1SFL447102R1311	2.170
		250...500	250...500	1	1	AF140-40-11B-14	1SFL447102R1411	2.170

(1) For other auxiliary contacts arrangements, please contact your ABB local organization.

Main dimensions mm, inches

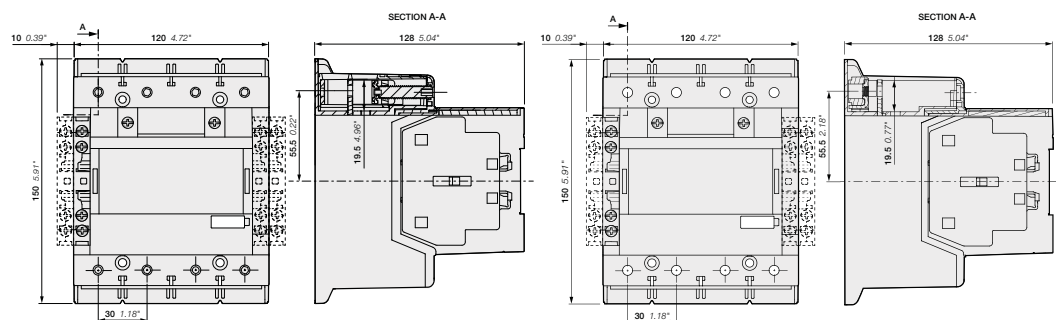

AF116, AF140-40-11

AF116, AF140-40-11B

1SFC101198C0201 - Rev. B

AF190 ... AF370 4-pole contactors

275 to 525 A AC-1

AC / DC operated with 1 N.O. + 1 N.C. auxiliary contacts

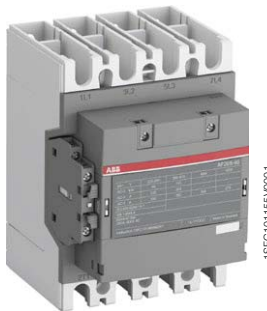

AF205-40-11



AF370-40-11

Description

AF190 ... AF370 4-pole contactors are mainly used for controlling non-inductive or slightly inductive loads (i.e. resistance furnaces...) and generally for controlling power circuits up to 1000 V AC and 440 V DC. These contactors are of the block type design with 4 main poles.

- control circuit: AC or DC operated with electronic coil interface accepting a wide control voltage range (e.g. 100...250 V AC and DC), only 4 coils to cover control voltages between 24...500 V 50/60 Hz and 20...500 V DC
- can manage large control voltage variations
- reduced panel energy consumption
- very distinct closing and opening
- can withstand short voltage dips and voltage sags (SEMI F47 conditions of use on request).
- built-in surge suppression
- add-on auxiliary contact blocks for side mounting and a wide range of accessories.

Ordering details

IEC Rated operational current $\theta \leq 40^\circ\text{C}$ AC-1	UL / CSA General use rating 600 V AC	Rated control circuit voltage Uc min. ... Uc max.		Auxiliary contacts fitted		Type (1)	Order code	Weight Pkg (1 pce) kg
A	A	V 50/60 Hz	V DC	1	2			
4 N.O. main poles								
275	230	24...60	20...60	1	1	AF190-40-11-11	1SFL487102R1111	3.920
		48...130	48...130	1	1	AF190-40-11-12	1SFL487102R1211	3.920
		100...250	100...250	1	1	AF190-40-11-13	1SFL487102R1311	3.920
		250...500	250...500	1	1	AF190-40-11-14	1SFL487102R1411	3.920
350	250	24...60	20...60	1	1	AF205-40-11-11	1SFL527102R1111	3.920
		48...130	48...130	1	1	AF205-40-11-12	1SFL527102R1211	3.920
		100...250	100...250	1	1	AF205-40-11-13	1SFL527102R1311	3.920
		250...500	250...500	1	1	AF205-40-11-14	1SFL527102R1411	3.920
400	300	24...60	20...60	1	1	AF265-40-11-11	1SFL547102R1111	6.380
		48...130	48...130	1	1	AF265-40-11-12	1SFL547102R1211	6.380
		100...250	100...250	1	1	AF265-40-11-13	1SFL547102R1311	6.380
		250...500	250...500	1	1	AF265-40-11-14	1SFL547102R1411	6.380
500	350	24...60	20...60	1	1	AF305-40-11-11	1SFL587102R1111	6.380
		48...130	48...130	1	1	AF305-40-11-12	1SFL587102R1211	6.380
		100...250	100...250	1	1	AF305-40-11-13	1SFL587102R1311	6.380
		250...500	250...500	1	1	AF305-40-11-14	1SFL587102R1411	6.380
525	420	24...60	20...60	1	1	AF370-40-11-11	1SFL607102R1111	6.380
		48...130	48...130	1	1	AF370-40-11-12	1SFL607102R1211	6.380
		100...250	100...250	1	1	AF370-40-11-13	1SFL607102R1311	6.380
		250...500	250...500	1	1	AF370-40-11-14	1SFL607102R1411	6.380

(1) For other auxiliary contacts arrangements, please contact your ABB local organization.

Main dimensions mm, inches

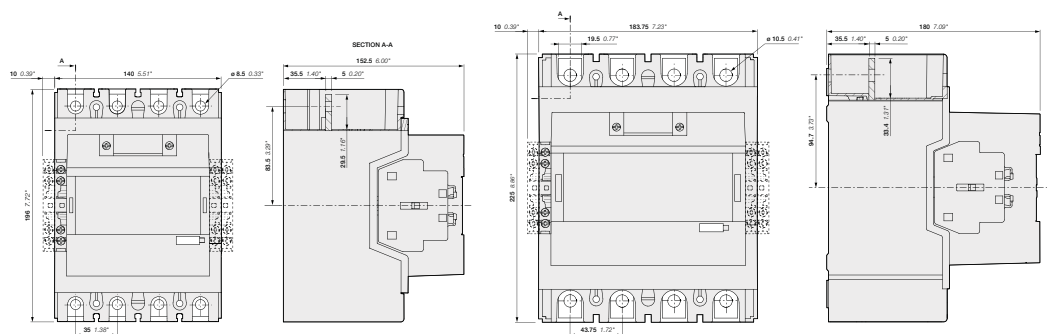

AF190, AF205

AF265, AF305, AF370

AF116 ... AF370 4-pole contactors with 1 N.O. + 1 N.C. auxiliary contacts Main accessories

Main accessories (other accessories available)

5

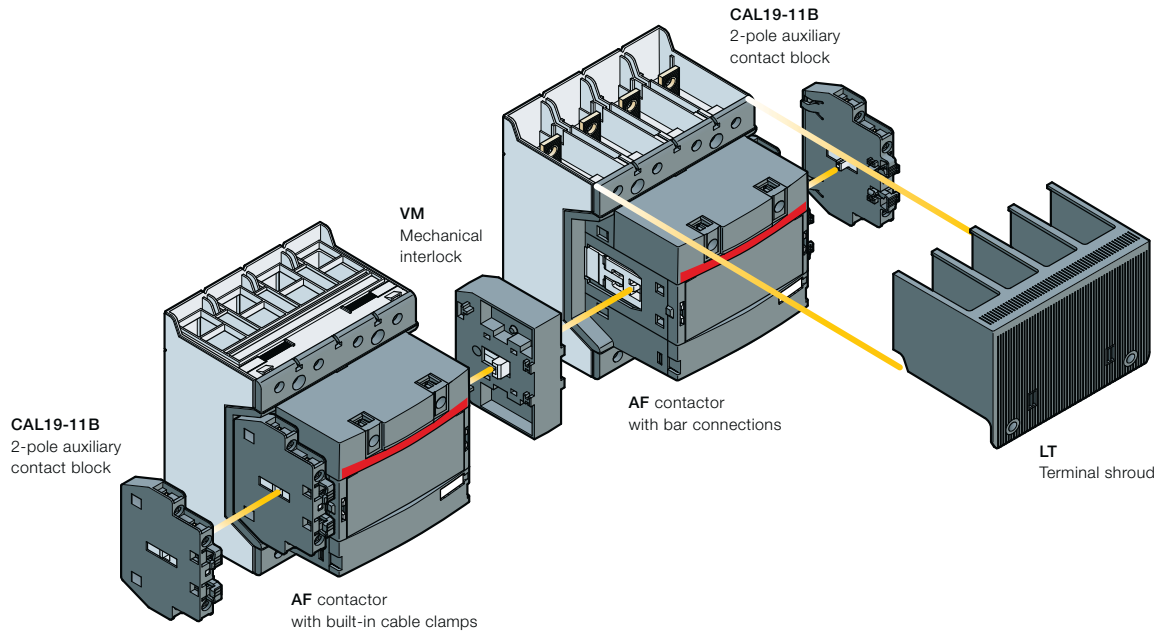

Main accessory fitting details

Contactor types	Main poles	Available auxiliary contacts	Side-mounted accessories		
			Auxiliary contact blocks		Mechanical interlock units (between two contactors)
			CAL19-11	CAL19-11B	
AF116 ... AF370	4	0 1 1	1 x CAL19-11	+ 2 x CAL19-11B	–
AF116 ... AF370	4	0 1 1	–	+ 2 x CAL19-11B (1)	+ VM... (2)

(1) Total number of auxiliary contact blocks for the two contactors.

(2) Interlock type, according to the contactor ratings (see "Accessories").

AF116 ... AF370 4-pole contactors with 1 N.O. + 1 N.C. auxiliary contacts Main accessories



CAL19-11



1SFC101071V0001



VM19

1SFC101035V0001

Ordering details (1)

For contactors	Auxiliary contacts		Type	Order code	Pkg qty	Weight (1 pce)
						kg

Side-mounted instantaneous auxiliary contact blocks

AF116 ... AF370	1	1	CAL19-11	1SFN010820R1011	2	0.050
	1	1	CAL19-11B	1SFN010820R3311	2	0.050

Mechanical interlock unit

AF116 ... AF370	VM19	1SFN030300R1000	1	0.054
AF116 ... AF146 and AF190, AF205	VM140/190	1SFN034403R1000	1	0.088
AF190, AF205 and AF265 ... AF370	VM205/265	1SFN035203R1000	1	0.090

Terminal shrouds

AF116 ... AF140, with compression lugs	LT140-40L	1SFN124203R2000	2	0.090
AF190 ... AF205, with cable clamps	LT205-40C	1SFN124801R2000	2	0.060
AF190 ... AF205, with compression lugs	LT205-40L	1SFN124803R2000	2	0.290
AF265 ... AF370, with cable clamps	LT370-40C	1SFN125401R2000	2	0.040
AF265 ... AF370, with compression lugs	LT370-40L	1SFN125403R2000	2	0.370

5

For contactors	Dimensions		Type	Order code	Pkg qty	Weight (1 pce)
	hole Ø mm	bar mm				

Terminal enlargements

AF190 ... AF205	10.5	20 x 5	LW205-40	1SFN074807R2000	1	0.306
AF265 ... AF370	10.5	25 x 5	LW370-40	1SFN075407R2000	1	0.540

(1) For more information, refer to "Accessories" section.

AF116 ... AF140 4-pole contactors

160 to 200 A AC-1

AC / DC operated with 2 N.O. + 2 N.C. auxiliary contacts



AF140-40-22



AF140-40-22B

Description

AF116 ... AF140 4-pole contactors are mainly used for controlling non-inductive or slightly inductive loads (i.e. resistance furnaces...) and generally for controlling power circuits up to 690 V AC and 350 V DC. These contactors are of the block type design with 4 main poles.

- control circuit: AC or DC operated with electronic coil interface accepting a wide control voltage range (e.g. 100...250 V AC and DC), only 4 coils to cover control voltages between 24...500 V 50/60 Hz and 20...500 V DC
- can manage large control voltage variations
- reduced panel energy consumption
- very distinct closing and opening
- can withstand short voltage dips and voltage sags (SEMI F47 conditions of use on request).
- built-in surge suppression
- add-on auxiliary contact blocks for side mounting and a wide range of accessories.

Ordering details

IEC Rated operational current $\theta \leq 40^\circ\text{C}$ AC-1 A	UL / CSA General use rating 600 V AC A	Rated control circuit voltage Uc min. ... Uc max. V 50/60 Hz V DC		Auxiliary contacts fitted 	Type (1)	Order code	Weight Pkg (1 pce) kg
--	--	---	--	-------------------------------------	-------------	------------	--------------------------------

4 N.O. main poles

For connection with built-in cable clamps

Rated current (A)	UL/CSA rating (A)	Uc min. (V)	Uc max. (V)	N.O. (2)	N.C. (2)	Type	Order code	Weight (kg)
160	160	24...60	20...60	2	2	AF116-40-22-11	1SFL427101R1122	2.290
		48...130	48...130	2	2	AF116-40-22-12	1SFL427101R1222	2.290
		100...250	100...250	2	2	AF116-40-22-13	1SFL427101R1322	2.290
		250...500	250...500	2	2	AF116-40-22-14	1SFL427101R1422	2.290
200	175	24...60	20...60	2	2	AF140-40-22-11	1SFL447101R1122	2.290
		48...130	48...130	2	2	AF140-40-22-12	1SFL447101R1222	2.290
		100...250	100...250	2	2	AF140-40-22-13	1SFL447101R1322	2.290
		250...500	250...500	2	2	AF140-40-22-14	1SFL447101R1422	2.290

With bar connections

Rated current (A)	UL/CSA rating (A)	Uc min. (V)	Uc max. (V)	N.O. (2)	N.C. (2)	Type	Order code	Weight (kg)
160	160	24...60	20...60	2	2	AF116-40-22B-11	1SFL427102R1122	2.190
		48...130	48...130	2	2	AF116-40-22B-12	1SFL427102R1222	2.190
		100...250	100...250	2	2	AF116-40-22B-13	1SFL427102R1322	2.190
		250...500	250...500	2	2	AF116-40-22B-14	1SFL427102R1422	2.190
200	175	24...60	20...60	2	2	AF140-40-22B-11	1SFL447102R1122	2.190
		48...130	48...130	2	2	AF140-40-22B-12	1SFL447102R1222	2.190
		100...250	100...250	2	2	AF140-40-22B-13	1SFL447102R1322	2.190
		250...500	250...500	2	2	AF140-40-22B-14	1SFL447102R1422	2.190

(1) For other auxiliary contacts arrangements, please contact your ABB local organization.

Main dimensions mm, inches

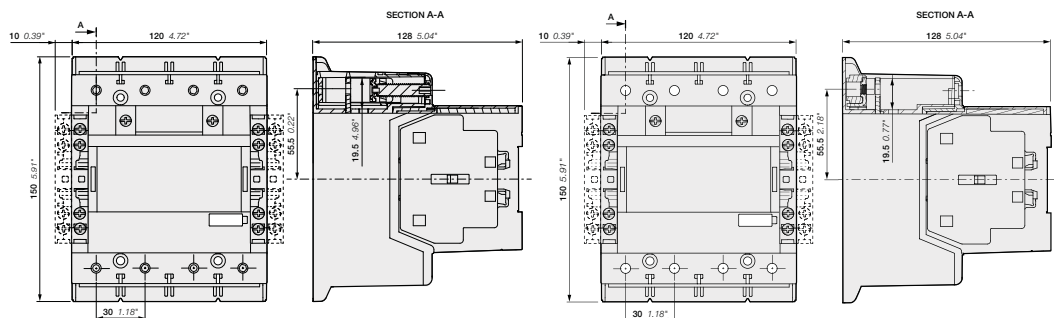

AF116, AF140-40-11

AF116, AF140-40-11B

1SFC101201C0201 - Rev. B

AF190 ... AF370 4-pole contactors

275 to 525 A AC-1

AC / DC operated with 2 N.O. + 2 N.C. auxiliary contacts

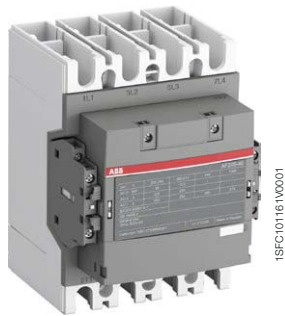

AF205-40-22

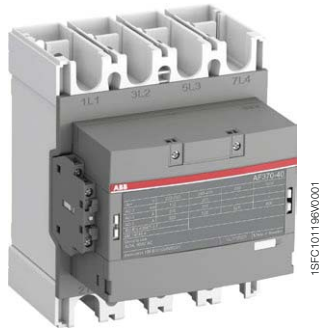

AF370-40-22

Description

AF190 ... AF370 4-pole contactors are mainly used for controlling non-inductive or slightly inductive loads (i.e. resistance furnaces...) and generally for controlling power circuits up to 1000 V AC and 440 V DC. These contactors are of the block type design with 4 main poles.

- control circuit: AC or DC operated with electronic coil interface accepting a wide control voltage range (e.g. 100...250 V AC and DC), only 4 coils to cover control voltages between 24...500 V 50/60 Hz and 20...500 V DC
- can manage large control voltage variations
- reduced panel energy consumption
- very distinct closing and opening
- can withstand short voltage dips and voltage sags (SEMI F47 conditions of use on request).
- built-in surge suppression
- add-on auxiliary contact blocks for side mounting and a wide range of accessories.

Ordering details

IEC Rated operational current $\theta \leq 40^\circ\text{C}$ AC-1	UL / CSA General use rating 600 V AC	Rated control circuit voltage Uc min. ... Uc max.		Auxiliary contacts fitted		Type (1)	Order code	Weight Pkg (1 pce) kg
A	A	V 50/60 Hz	V DC	1	2			
4 N.O. main poles								
275	230	24...60	20...60	2	2	AF190-40-22-11	1SFL487102R1122	3.940
		48...130	48...130	2	2	AF190-40-22-12	1SFL487102R1222	3.940
		100...250	100...250	2	2	AF190-40-22-13	1SFL487102R1322	3.940
		250...500	250...500	2	2	AF190-40-22-14	1SFL487102R1422	3.940
350	250	24...60	20...60	2	2	AF205-40-22-11	1SFL527102R1122	3.940
		48...130	48...130	2	2	AF205-40-22-12	1SFL527102R1222	3.940
		100...250	100...250	2	2	AF205-40-22-13	1SFL527102R1322	3.940
		250...500	250...500	2	2	AF205-40-22-14	1SFL527102R1422	3.940
400	300	24...60	20...60	2	2	AF265-40-22-11	1SFL547102R1122	6.400
		48...130	48...130	2	2	AF265-40-22-12	1SFL547102R1222	6.400
		100...250	100...250	2	2	AF265-40-22-13	1SFL547102R1322	6.400
		250...500	250...500	2	2	AF265-40-22-14	1SFL547102R1422	6.400
500	350	24...60	20...60	2	2	AF305-40-22-11	1SFL587102R1122	6.400
		48...130	48...130	2	2	AF305-40-22-12	1SFL587102R1222	6.400
		100...250	100...250	2	2	AF305-40-22-13	1SFL587102R1322	6.400
		250...500	250...500	2	2	AF305-40-22-14	1SFL587102R1422	6.400
525	420	24...60	20...60	2	2	AF370-40-22-11	1SFL607102R1122	6.400
		48...130	48...130	2	2	AF370-40-22-12	1SFL607102R1222	6.400
		100...250	100...250	2	2	AF370-40-22-13	1SFL607102R1322	6.400
		250...500	250...500	2	2	AF370-40-22-14	1SFL607102R1422	6.400

(1) For other auxiliary contacts arrangements, please contact your ABB local organization.

Main dimensions mm, inches

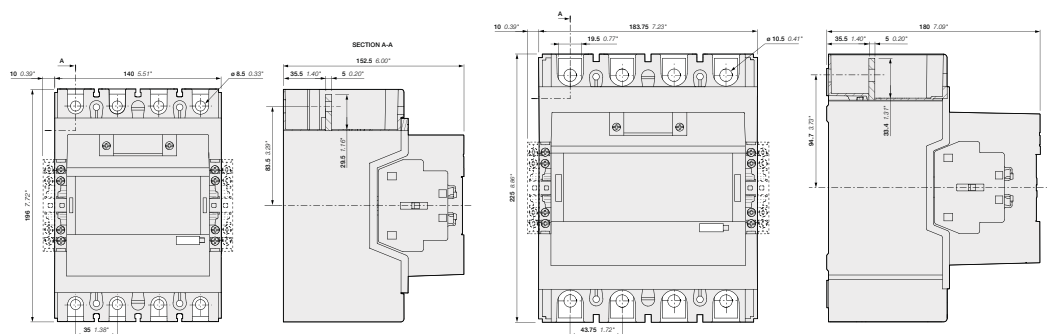

AF190, AF205

AF265, AF305, AF370

AF116 ... AF370 4-pole contactors with 2 N.O. + 2 N.C. auxiliary contacts Main accessories

Main accessories (other accessories available)

5

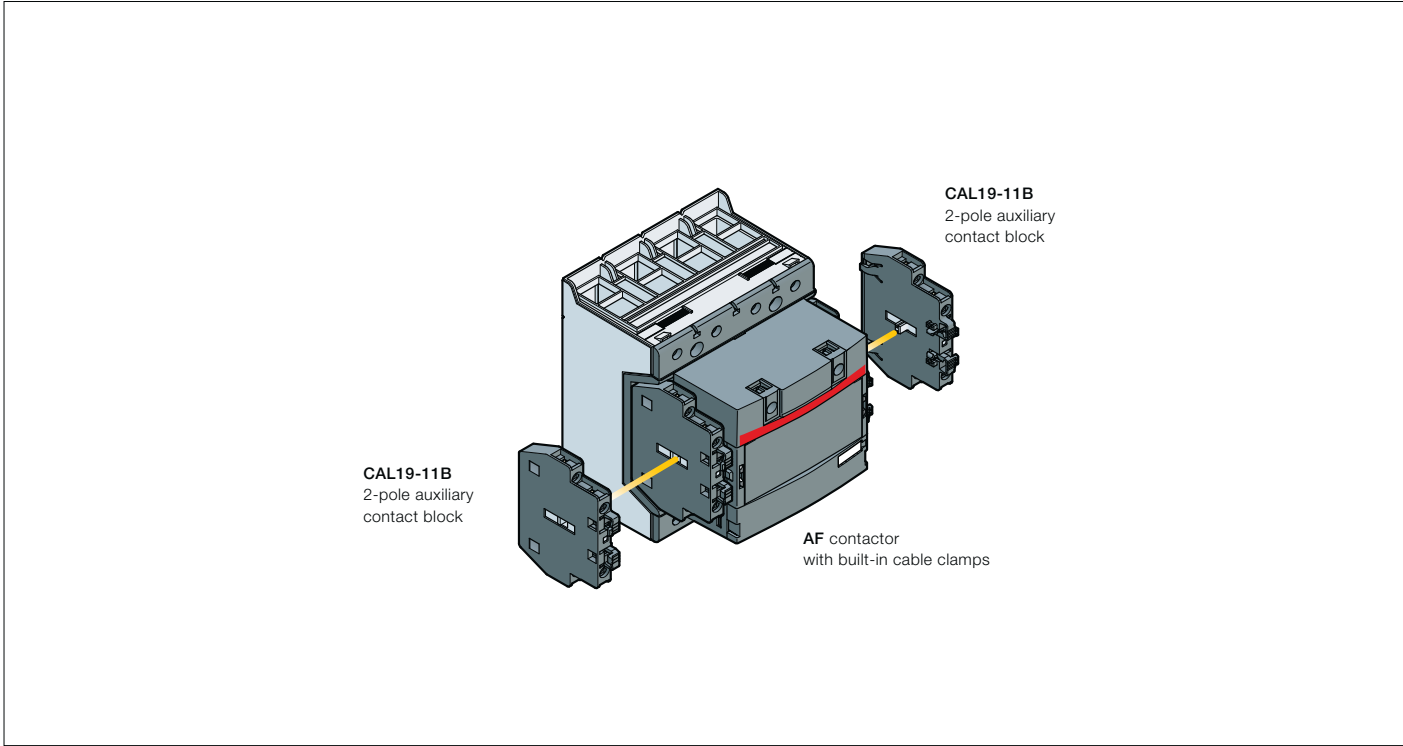

Main accessory fitting details

Contactor types	Main poles	Available auxiliary contacts	Side-mounted accessories		
			Auxiliary contact blocks		Mechanical interlock units (between two contactors)
			CAL19-11 (1)	CAL19-11B (1)	
AF116 ... AF370	4	0 2 2	2 x CAL19-11 included	+ 2 x CAL19-11B	-

(1) The CEL19 auxiliary contact blocks can replace the CAL19-11 and CAL19-11B. Though, no auxiliary contact block can be mounted outside the CEL19.



AF116 ... AF370 4-pole contactors with 2 N.O. + 2 N.C. auxiliary contacts Main accessories



CAL19-11

1SFC10107110001

Ordering details (1)

For contactors	Auxiliary contacts	Type	Order code	Pkg qty	Weight (1 pce)
	 				kg

Side-mounted instantaneous auxiliary contact blocks

AF116 ... AF370	1	1	CAL19-11B	1SFN010820R3311	2	0.050
-----------------	---	---	-----------	-----------------	---	-------

Terminal shrouds

AF116 ... AF140, with compression lugs		LT140-40L	1SFN124203R2000	2	0.090
AF190 ... AF205, with cable clamps		LT205-40C	1SFN124801R2000	2	0.060
AF190 ... AF205, with compression lugs		LT205-40L	1SFN124803R2000	2	0.290
AF265 ... AF370, with cable clamps		LT370-40C	1SFN125401R2000	2	0.040
AF265 ... AF370, with compression lugs		LT370-40L	1SFN125403R2000	2	0.370

For contactors	Dimensions		Type	Order code	Pkg qty	Weight (1 pce)
	hole Ø mm	bar mm				
						kg

Terminal enlargements

AF190 ... AF205	10.5	20 x 5	LW205-40	1SFN074807R2000	1	0.306
AF265 ... AF370	10.5	25 x 5	LW370-40	1SFN075407R2000	1	0.540

(1) For more information, refer to "Accessories" section.

EK550, EK1000 4-pole contactors

800 to 1000 A AC-1

AC operated - with 1 N.O. + 1 N.C. auxiliary contacts



1SFC381039-000

EK1000-40-11



Description

EK550 4-pole contactors are mainly used for controlling non-inductive or slightly inductive loads (i.e. resistance furnaces...) and generally for controlling power circuits up to 1000 V AC and 600 V DC, EK1000 up to 1000 V AC.

These contactors are of the block type design with:

- 4 main poles
- control circuit: AC operated
- add-on auxiliary contact blocks for side mounting and a wide range of accessories.

Ordering details

IEC Rated operational current $\theta \leq 40^\circ\text{C}$ AC-1	UL/CSA General use rating 600 V AC	Rated control circuit voltage U_c (1)		Auxiliary contacts fitted		Type	Order code	Weight Pkg (1 pce) kg		
		V 50 Hz	V 60 Hz							
800	540	48	-	1	1	EK550-40-11	SK827041-AD	17.200		
		110	110...120	1	1	EK550-40-11	SK827041-EF	17.200		
		110...115	115...127	1	1	EK550-40-11	SK827041-EG	17.200		
		220	220...240	1	1	EK550-40-11	SK827041-EL	17.200		
		220...230	230...255	1	1	EK550-40-11	SK827041-EM	17.200		
		380	380...415	1	1	EK550-40-11	SK827041-EP	17.200		
		380...400	400...440	1	1	EK550-40-11	SK827041-ER	17.200		
		400...415	-	1	1	EK550-40-11	SK827041-AR	17.200		
		1000	-	48	-	1	1	EK1000-40-11	SK827044-AD	17.500
				110	110...120	1	1	EK1000-40-11	SK827044-EF	17.500
110...115	115...127			1	1	EK1000-40-11	SK827044-EG	17.500		
220	220...240			1	1	EK1000-40-11	SK827044-EL	17.500		
220...230	230...255			1	1	EK1000-40-11	SK827044-EM	17.500		
380	380...415			1	1	EK1000-40-11	SK827044-EP	17.500		
380...400	400...440			1	1	EK1000-40-11	SK827044-ER	17.500		
400...415	-			1	1	EK1000-40-11	SK827044-AR	17.500		

(1) Other control voltages see voltage code table.

Main dimensions mm, inches

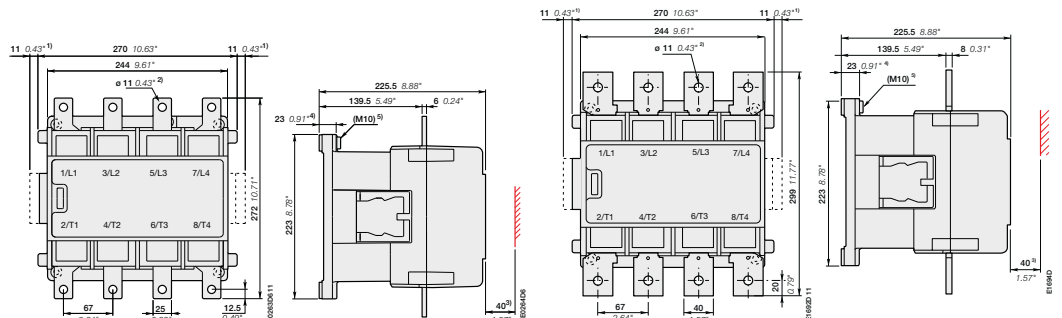

EK550

- 1) Dimension for extra auxiliary contact block.
- 2) Screw, nut and washer by-packed.
- 3) Min. distance to uninsulated wall.
- 4) Damping elements are included.
- 5) Earthing screw.

EK1000

EK550, EK1000 4-pole contactors

800 to 1000 A AC-1

DC operated - with 2 N.O. + 1 N.C. auxiliary contacts



EK1000-40-21

Description

EK550 4-pole contactors are mainly used for controlling non-inductive or slightly inductive loads (i.e. resistance furnaces...) and generally for controlling power circuits up to 1000 V AC and 600 V DC, EK1000 up to 1000 V AC.

These contactors are of the block type design with:

- 4 main poles
- control circuit: DC operated
- add-on auxiliary contact blocks for side mounting and a wide range of accessories.

Ordering details

IEC	UL / CSA	Rated control circuit voltage Uc	Auxiliary contacts fitted	Type	Order code	Weight
Rated operational current $\theta \leq 40^\circ\text{C}$ AC-1	General use rating 600 V AC					Pkg (1 pce) kg
A	A	V DC				
800	540	24	2 1	EK550-40-21	SK827041-DB	17.200
		36	2 1	EK550-40-21	SK827041-DC	17.200
		48	2 1	EK550-40-21	SK827041-DD	17.200
		60	2 1	EK550-40-21	SK827041-DT	17.200
		75	2 1	EK550-40-21	SK827041-DG	17.200
		110	2 1	EK550-40-21	SK827041-DE	17.200
		125	2 1	EK550-40-21	SK827041-DU	17.200
		220	2 1	EK550-40-21	SK827041-DF	17.200
1000	-	24	2 1	EK1000-40-21	SK827044-DB	17.500
		36	2 1	EK1000-40-21	SK827044-DC	17.500
		48	2 1	EK1000-40-21	SK827044-DD	17.500
		60	2 1	EK1000-40-21	SK827044-DT	17.500
		75	2 1	EK1000-40-21	SK827044-DG	17.500
		110	2 1	EK1000-40-21	SK827044-DE	17.500
		125	2 1	EK1000-40-21	SK827044-DU	17.500
		220	2 1	EK1000-40-21	SK827044-DF	17.500

Main dimensions mm, inches

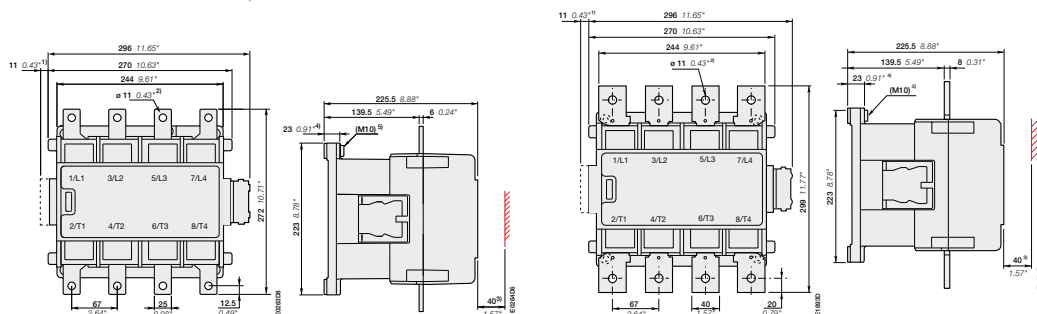

EK550

- 1) Dimension for extra auxiliary contact block.
- 2) Screw, nut and washer by-packed.
- 3) Min. distance to uninsulated wall.
- 4) Damping elements are included.
- 5) Earthing screw.

EK1000

EK550, EK1000 4-pole Contactors

800 to 1000 A AC-1

AC operated - with 2 N.O. + 2 N.C. auxiliary contacts





EK1000-40-22

Description

EK550 4-pole contactors are mainly used for controlling non-inductive or slightly inductive loads (i.e. resistance furnaces...) and for controlling power circuits up to 1000 V AC and 600 V DC, EK1000 up to 1000 V AC. These contactors are of the block type design with:

- 4 main poles
- control circuit: AC operated
- add-on auxiliary contact blocks for side mounting and a wide range of accessories

Ordering details

IEC Rated operational current $\theta \leq 40^\circ\text{C}$ AC-1 A	UL/CSA General use rating 600 V AC A	Rated control circuit voltage U_c (1)		Auxiliary contacts fitted		Type	Order code	Weight Pkg (1 pce) kg
		V 50 Hz	V 60 Hz					
800	540	48	-	2	2	EK550-40-22	SK827043-AD	17.200
		110	110...120	2	2	EK550-40-22	SK827043-EF	17.200
		110...115	115...127	2	2	EK550-40-22	SK827043-EG	17.200
		220	220...240	2	2	EK550-40-22	SK827043-EL	17.200
		220...230	230...255	2	2	EK550-40-22	SK827043-EM	17.200
		380	380...415	2	2	EK550-40-22	SK827043-EP	17.200
		380...400	400...440	2	2	EK550-40-22	SK827043-ER	17.200
		400...415	-	2	2	EK550-40-22	SK827043-AR	17.200
1000	-	48	-	2	2	EK1000-40-22	SK827045-AD	17.500
		110	110...120	2	2	EK1000-40-22	SK827045-EF	17.500
		110...115	115...127	2	2	EK1000-40-22	SK827045-EG	17.500
		220	220...240	2	2	EK1000-40-22	SK827045-EL	17.500
		220...230	230...255	2	2	EK1000-40-22	SK827045-EM	17.500
		380	380...415	2	2	EK1000-40-22	SK827045-EP	17.500
		380...400	400...440	2	2	EK1000-40-22	SK827045-ER	17.500
		400...415	-	2	2	EK1000-40-22	SK827045-AR	17.500

(1) Other control voltages see voltage code table.

Main dimensions mm, inches

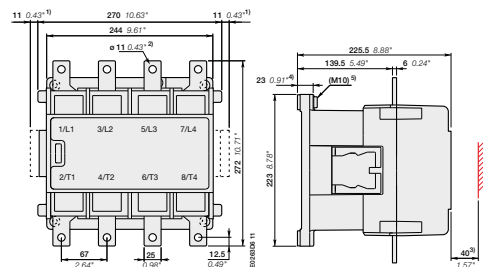

EK550

- 1) Dimension for extra auxiliary contact block
- 2) Screw, nut and washer by-packed
- 3) Min. distance to uninsulated wall
- 4) Damping elements are included
- 5) Earthing screw

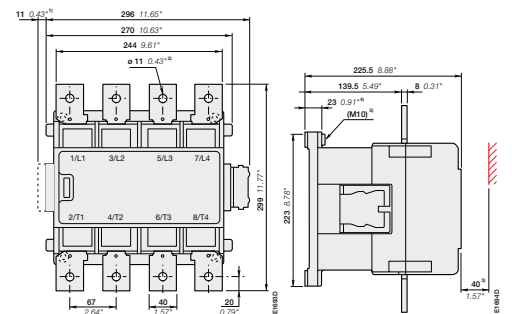

EK1000

Notes

A series of horizontal dotted lines for writing notes, spanning the width of the page.

EK550, EK1000 4-pole contactors with 1 N.O. + 1 N.C. auxiliary contacts and 2 N.O. + 1 N.C. auxiliary contacts

Main accessory fitting details

Mounting positions of the auxiliary contact

Auxiliary contact types and connecting diagrams

(1) Contact 35-36 used for some types of EK... contactors

EK 4-pole contactors

Contactor types	Main poles	Available auxiliary contacts	Add-on auxiliary contact blocks	Mounting and positioning
			2-pole CAL16-11 ...	
AC operated, 50 Hz, 60 Hz or 50/60 Hz				
EK550, EK1000	4	0 1 1	+ 1 x CAL16-11B + 1 x CAL16-11C + 1 x CAL16-11D	
DC operated				
EK550, EK1000	4	0 2 1	+ 1 x CAL16-11C	

EK 4-pole reversing contactors with VH800 mechanical and electrical interlock units

"Left hand" contactors	Interlocking	"Right hand" contactors	Add-on auxiliary contact blocks	Mounting and positioning
			2-pole CAL16-11 ...	
AC operated, 50 Hz, 60 Hz or 50/60 Hz				
EK550, EK1000	VH800	EK550, EK1000	+ 1 x CAL16-11C + 1 x CAL16-11D	
DC operated				
EK550, EK1000	VH800	EK550, EK1000	—	

EK550, EK1000 4-pole contactors with 1 N.O. + 1 N.C. auxiliary contacts and 2 N.O. + 1 N.C. auxiliary contacts

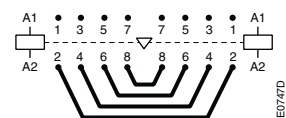

BSS550 ... BSS1000

ED747D



RC-EH

A07B

Ordering details (1)

For contactors	Auxiliary contacts	Type	Order code	Pkg qty	Weight (1 pce)
					kg

Side-mounted auxiliary contact blocks

EK	1	1	CAL16-11B	SK829002-B	1	0.050
	1	1	CAL16-11C	SK829002-C	1	0.050
	1	1	CAL16-11D	SK829002-D	1	0.050
	1	1	CCL16-11E (2)	SK829002-E	1	0.050

Mechanical interlock unit for two horizontal mounted contactors

EK550, EK1000	VH800	SK829070-F	1	6.000
---------------	-------	------------	---	-------

Connecting sets

EK550	BSS550	SK829090-E	1	3.300
EK1000	BSS1000	SK829090-H	1	5.500

Surge suppressors

For contactors	Rated control circuit voltage U _c		Type	Order code	Pkg qty	Weight (1 pce)	
	V	AC					DC
EK550, EK1000	48...110	●	-	RC-EH800/110	SK829007-C	1	0.015
EK550, EK1000	24...125	-	●	RC-EH800/110	SK829007-C	1	0.015
EK550, EK1000	220...600	●	-	RC-EH800/600	SK829007-D	1	0.015

(1) See "Main accessory fitting details" table.

(2) Mounting of CCL16-11E blocks does not allow an additional second block to be added on top of it. All DC operated EK contactors are equipped with one CCL16-11E on the right side.

AF09 ... AF80 4-pole contactors

Technical data

Main pole - Utilization characteristics according to IEC

Contactor types	AC / DC operated	AF09	AF16	AF26	AF38	AF40	AF52	AF80
Standards		IEC 60947-1 / 60947-4-1 and EN 60947-1 / 60947-4-1						
Rated operational voltage U_e max.		690 V						
Rated frequency (without derating)		50 / 60 Hz						
Conventional free-air thermal current I_{th}								
acc. to IEC 60947-4-1, open contactors, $\theta \leq 40^\circ\text{C}$		35 A	35 A	55 A	55 A	105 A	105 A	125 A
With conductor cross-sectional area		6 mm ²	6 mm ²	16 mm ²	16 mm ²	35 mm ²	35 mm ²	50 mm ²
AC-1 Utilization category								
For air temperature close to contactor								
I_e / Rated operational current AC-1	$\theta \leq 40^\circ\text{C}$	25 A	30 A	45 A	55 A	70 A	100 A	125 A
U_e max. ≤ 690 V, 50/60 Hz	$\theta \leq 60^\circ\text{C}$	25 A	30 A	40 A	45 A	60 A	80 A	105 A
	$\theta \leq 70^\circ\text{C}$	22 A	26 A	32 A	37 A	50 A	70 A	90 A
With conductor cross-sectional area		4 mm ²	6 mm ²	10 mm ²	16 mm ²	35 mm ²	35 mm ²	50 mm ²
AC-3 Utilization category								
For air temperature close to contactor $\theta \leq 60^\circ\text{C}$								
I_e / Max. rated operational current AC-3 (1)								
	220-230-240 V	9 A	18 A	23.2 A	23.2 A	40 A	53 A	80 A
	380-400 V	9 A	18 A	22 A	22 A	40 A	53 A	80 A
	415 V	9 A	18 A	21.2 A	21.2 A	40 A	53 A	80 A
	440 V	9 A	18 A	20 A	20 A	40 A	53 A	80 A
	500 V	9.5 A	15 A	17.6 A	17.6 A	35 A	45 A	65 A
	690 V	7 A	10.5 A	10.5 A	10.5 A	25 A	35 A	49 A
Rated operational power AC-3 (1)								
	220-230-240 V	2.2 kW	4 kW	5.5 kW	5.5 kW	11 kW	15 kW	22 kW
	380-400 V	4 kW	7.5 kW	11 kW (3)	11 kW (3)	18.5 kW	22 kW	37 kW
	415 V	4 kW	9 kW	11 kW	11 kW	22 kW	30 kW	45 kW
	440 V	4 kW	9 kW	11 kW	11 kW	22 kW	30 kW	45 kW
	500 V	5.5 kW	9 kW	11 kW	11 kW	22 kW	30 kW	45 kW
	690 V	5.5 kW	9 kW	9 kW	9 kW	22 kW	30 kW	45 kW
Rated making capacity AC-3		10 x I_e AC-3 acc. to IEC 60947-4-1						
Rated breaking capacity AC-3		8 x I_e AC-3 acc. to IEC 60947-4-1						
Short-circuit protection device for contactors								
Without thermal overload relay - Motor protection excluded								
$U_e \leq 500$ V AC - gG type fuse		25 A	32 A	50 A	63 A	80 A	110 A	160 A
Rated short-time withstand current I_{cw}	1 s	300 A	300 A	450 A	450 A	1000 A	1000 A	1200 A
At 40 °C ambient temperature, in free air from a cold state	10 s	150 A	150 A	300 A	300 A	600 A	600 A	780 A
	30 s	80 A	80 A	225 A	225 A	350 A	350 A	450 A
	1 min	60 A	60 A	150 A	150 A	250 A	250 A	300 A
	15 min	35 A	35 A	55 A	55 A	110 A	110 A	140 A
Maximum breaking capacity N.O. main pole	at 440 V	250 A	250 A	-	-	950 A	950 A	1100 A
$\cos \varphi = 0.45$	at 690 V	106 A	106 A	-	-	600 A	600 A	750 A
	N.C. Main pole	at 440 V	-	-	-	600 A	-	900 A
	at 690 V	-	-	-	-	300 A	-	750 A
Power dissipation per pole	I_e / AC-1	0.8 W	1.2 W	1.6 W	2.3 W	3 W	6.3 W	8 W
	I_e / AC-3	0.1 W	0.35 W	0.42 W	0.42 W	1 W	1.7 W	3.2 W
Max. electrical switching frequency	AC-1	600 cycles/h						



3-phase motors



1500 r.p.m. 50 Hz
1800 r.p.m. 60 Hz
3-phase motors

(1) For the corresponding kW/A values of 1500 r.p.m, 50 Hz or 1800 r.p.m, 60 Hz, 3-phase motors, see "Motor Rated Operational Powers and Currents"

(2) For the protection of motor starters against short circuits, see "Coordination with Short-circuit Protection Devices".

(3) 400 V 3-phase motors only.

AF116 ... AF370 4-pole contactors

Technical data

Main pole - Utilization characteristics according to IEC

Contactor types	AC / DC operated	AF116	AF140	AF190	AF205	AF265	AF305	AF370	EK550	EK1000	
Standards		IEC 60947-1 / 60947-4-1 and EN 60947-1 / 60947-4-1									
Rated operational voltage U _e max.		690 V		1000 V							
Rated frequency (without derating)		50 / 60 Hz									
Conventional free-air thermal current I _{th} acc. to IEC 60947-4-1, open contactors, $\theta \leq 40$ °C With conductor cross-sectional area		160 A 70 mm ²	200 A 95 mm ²	275 A 150 mm ²	350 A 240 mm ² (3)	400 A 240 mm ²	500 A 300 mm ² (4)	525 A 2x 185 mm ² (4)	800 A 2x 240 mm ²	1000 A 2x 300 mm ²	
AC-1 Utilization category For air temperature close to contactor I_e / Rated operational current AC-1 U _e max. \leq 690 V, 50/60 Hz	$\theta \leq 40$ °C	160 A	200 A	275 A	350 A	400 A	500 A	525 A	800 A	1000 A	
	$\theta \leq 60$ °C	145 A	175 A	250 A	300 A	350 A	400 A	425 A	650 A	800 A	
	$\theta \leq 70$ °C	130 A	160 A	200 A	240 A	290 A	325 A	350 A	575 A	720 A	
U _e max. \leq 1000 V, 50/60 Hz	$\theta \leq 40$ °C	-	-	250 A	275 A	350 A	375 A	400 A	800 A	1000 A	
	$\theta \leq 60$ °C (2)	-	-	225 A	250 A	300 A	325 A	350 A	650 A	800 A	
	$\theta \leq 70$ °C	-	-	185 A	200 A	240 A	260 A	290 A	575 A	720 A	
With conductor cross-sectional area		70 mm ²	95 mm ²	150 mm ²	240 mm ² (3)	240 mm ²	300 mm ² (4)	2x 185 mm ² (4)	2x 240 mm ²	2x 300 mm ²	
AC-3 Utilization category For air temperature close to contactor $\theta \leq 60$ °C (2) I_e / Max. rated operational current AC-3 (1)											
	220-230-240 V	116 A	140 A	190 A	205 A	265 A	305 A	370 A	550 A	-	
	380-400 V	116 A	140 A	190 A	205 A	265 A	305 A	370 A	550 A	-	
	415 V	116 A	140 A	190 A	205 A	265 A	305 A	370 A	550 A	-	
	440 V	116 A	140 A	190 A	205 A	265 A	305 A	370 A	550 A	-	
	500 V	-	-	-	-	-	-	-	550 A	-	
	690 V	-	-	-	-	-	-	-	550 A	-	
	1000 V	-	-	-	-	-	-	-	175 A	-	
Rated operational power AC-3 (1)											
	220-230-240 V	30 kW	37 kW	55 kW	55 kW	75 kW	90 kW	110 kW	160 kW	-	
	380-400 V	55 kW	75 kW	90 kW	110 kW	132 kW	160 kW	200 kW	280 kW	-	
	415 V	55 kW	75 kW	90 kW	110 kW	132 kW	160 kW	200 kW	315 kW	-	
	440 V	75 kW	90 kW	110 kW	132 kW	160 kW	160 kW	200 kW	315 kW	-	
	500 V	-	-	-	-	-	-	-	400 kW	-	
	690 V	-	-	-	-	-	-	-	500 kW	-	
	1000 V	-	-	-	-	-	-	-	250 kW	-	
Rated making capacity AC-3		10 x I _e AC-3 acc. to IEC 60947-4-1									
Rated breaking capacity AC-3		8 x I _e AC-3 acc. to IEC 60947-4-1									
Short-circuit protection device for contactors Without thermal overload relay - Motor protection excluded U _e \leq 500 V AC - gG type fuse		200 A	250 A	355 A	400 A	630 A	630 A	630 A	800 A	1000 A	
Rated short-time withstand current I_{cw} At 40 °C ambient temperature, in free air from a cold state	1 s	1300 A	1460 A	1900 A	2050 A	2650 A	3050 A	3700 A	5500 A	6800 A	
	10 s	928 A	1168 A	1520 A	1640 A	2120 A	2440 A	2960 A	5300 A	6400 A	
	30 s	536 A	674 A	878 A	947 A	1224 A	1409 A	1709 A	3700 A	4400 A	
	1 min	379 A	477 A	621 A	670 A	865 A	996 A	1208 A	3000 A	3400 A	
	15 min	160 A	200 A	275 A	350 A	400 A	500 A	525 A	1000 A	1200 A	
Maximum breaking capacity cos ϕ = 0.45	at 440 V	2000 A	3000 A	3300 A	3500 A	3800 A	4600 A	5000 A	5400 A	-	
	at 690 V	-	-	-	-	-	-	-	5400 A	-	
Power dissipation per pole	I _e / AC-1	12 W	18 W	15 W	25 W	32 W	50 W	72 W	60 W	80 W	
	I _e / AC-3	-	-	-	-	-	-	-	25 W	-	
Max. electrical switching frequency	AC-1	300 cycles/h									
	AC-3	300 cycles/h									
	AC-2, AC4	-							120 cycles/h		-



3-phase motors



1500 r.p.m. 50 Hz
1800 r.p.m. 60 Hz
3-phase motors

(1) For the corresponding kW/A or hp/A values of 1500 r.p.m, 50 Hz or 1800 r.p.m, 60 Hz, 3-phase motors, see "Motor rated operational powers and currents".

(2) $\theta \leq 55$ °C for EK550, EK1000

(3) For currents above 275 A use terminal enlargements or terminal extensions.

(4) For currents above 450 A use terminal enlargements or terminal extensions.

AF09 ... AF80 4-pole contactors

Technical data

Main pole - Utilization characteristics according to UL/NEMA/CSA

Contactor types	AC / DC operated	AF09	AF16	AF26	AF38	AF40	AF52	AF80
Standards		UL 508, CSA C22.2 N°14				UL 60947-4-1, CSA-C22.2 No. 60947-4-1		
Max. operational voltage		600 V						
UL / CSA general use rating								
	600 V AC	25 A	30 A	45 A	55 A	60 A	80 A	105 A
With conductor cross-sectional area		AWG 10	AWG 10	AWG 8	AWG 6	AWG 6	AWG 4	AWG 2
1 pole	80 V DC	25 A (1)	30 A (1)	45 A	55 A	60 A	80 A	105 A
2 poles in serie	160 V DC	25 A (1)	30 A (1)	45 A	55 A	60 A	80 A	105 A
3 poles in serie	240 V DC	25 A	30 A	45 A	55 A	60 A	80 A	105 A
4 poles in serie	320 V DC	25 A	30 A	45 A	55 A	60 A	80 A	105 A
With conductor cross-sectional area		AWG 10	AWG 10	AWG 8	AWG 8	AWG 6	AWG 4	AWG 2
Max. electrical switching frequency								
For general use		600 cycles/h						

Note: 4-pole contactors fitted with 2 N.O. + 2 N.C. main poles, see "General technical data".
 (1) 20 A for AF09...22-00 and AF16...22-00.

5

Main pole utilization characteristics - 4 N.O. non-reversing contactors

Contactor types	AC / DC operated	AF09	AF16	AF26	AF38	AF40	AF52	AF80
Lighting application - UL / CSA - breaking all lines								
Electrical discharge lamps (ballast)								
1-phase per pole	347 V AC	20 A	30 A	45 A	50 A	-	-	-
3-phase break all lines	600 V AC	20 A	30 A	45 A	50 A	-	-	-
Elevator control, load switching, 500 000 electrical operating cycles acc. to CSA B44.1 / ASME 17.5 paragraph 19.2.1								
1-phase								
Horse power rating	110-120 V AC	-	1/2 hp	-	-	-	-	-
	220-240 V AC	-	1-1/2 hp	-	-	-	-	-
3-phase								
Horse power rating	200-208 V AC	-	3 hp	-	-	-	-	-
	220-240 V AC	-	3 hp	-	-	-	-	-
	440-480 V AC	-	7-1/2 hp	-	-	-	-	-
	550-600 V AC	-	10 hp	-	-	-	-	-

Note: 4-pole contactors fitted with 2 N.O. + 2 N.C. main poles, see "General technical data".

AF116 ... AF370 4-pole contactors

Technical data

Main pole - Utilization characteristics according to UL/NEMA/CSA

Contactor types	AC / DC operated	AF116	AF140	AF146	AF190	AF205	AF265	AF305	AF370	EK550	EK1000
Standards		UL 60947-4-1								UL 508, CSA C22.2 N°14	
Max. operational voltage		600 V									
UL / CSA general use rating											
600 V AC		160 A	175 A	-	230 A	250 A	300 A	350 A	420 A	540 A	-
With conductor cross-sectional area		AWG 2/0	AWG 3/0	-	MCM 250	MCM 250	MCM 400	MCM 500	2//MCM 300	-	-
1 pole	90 V DC	200 A	200 A	-	-	-	-	-	-	-	-
	100 V DC	-	-	250 A	350 A	-	-	-	-	-	-
	110 V DC	-	-	-	-	400 A	500 A	520 A	-	-	-
2 poles in serie	175 V DC	200 A	200 A	-	-	-	-	-	-	-	-
	200 V DC	-	-	250 A	350 A	-	-	-	-	-	-
	225 V DC	-	-	-	-	400 A	500 A	520 A	-	-	-
3 poles in serie	260 V DC	200 A	200 A	-	-	-	-	-	-	-	-
	300 V DC	-	-	250 A	350 A	-	-	-	-	-	-
	340 V DC	-	-	-	-	400 A	500 A	520 A	-	-	-
4 poles in series	350 V DC	200 A	200 A	-	-	-	-	-	-	-	-
	400 V DC	-	-	250 A	350 A	-	-	-	-	-	-
	450 V DC	-	-	-	-	400 A	500 A	520 A	-	-	-
With conductor cross-sectional area		AWG 2/0	AWG 3/0	-	MCM 250	MCM 250	MCM 400	MCM 500	2//MCM 300	-	-
Max. electrical switching frequency											
For general use		300 cycles/h									

5

Main pole utilization characteristics - 4 N.O. non-reversing contactors

Contactor types	AC / DC operated	AF116	AF140	AF146	AF190	AF205	AF265	AF305	AF370	EK550	EK1000
Lighting application - UL/CSA - breaking all lines											
Electrical discharge lamps (ballast)											
1-phase per pole	347 V AC	160 A	200 A	200 A	250 A	300 A	400 A	450 A	520 A	-	-
3-phase break all lines	600 V AC	160 A	200 A	200 A	250 A	300 A	400 A	450 A	520 A	-	-

AF09 ... AF80 4-pole contactors

Technical data

General technical data

Contactor types	AC / DC operated	AF09	AF16	AF26	AF38	AF40	AF52	AF80
Rated insulation voltage U_i acc. to IEC 60947-4-1 acc. to UL / GSA		690 V						1000 V
Rated impulse withstand voltage U_{imp}		6 kV						8 kV
Electromagnetic compatibility		Devices complying with IEC 60947-1 / EN 60947-1 - Environment A and B (1)						
Ambient air temperature close to contactor Operation Storage		-40...+70 °C -60...+80 °C						
Climatic withstand		Category B according to IEC 60947-1 Annex Q						
Maximum operating altitude (without derating)		3000 m						
Mechanical durability Number of operating cycles Max. switching frequency		10 millions operating cycles 3600 cycles/h						
Shock withstand acc. to IEC 60068-2-27 and EN 60068-2-27 Mounting position 1		1/2 sinusoidal shock for 11 ms: no change in contact position, closed or open position						
	Shock direction							
	A	30 g						(2)
	B1	25 g closed position / 5 g open position						(2)
	B2	15 g						(2)
	C1	25 g						(2)
	C2	25 g						(2)
	A	30 g						(2)
	B1	25 g closed position / 5 g open position						(2)
	B2	15 g						(2)
	C1	25 g						(2)
	C2	25 g						(2)
	A	30 g						(2)
	B1	25 g closed position / 5 g open position						(2)
	B2	15 g						(2)
	C1	25 g						(2)
	C2	25 g						(2)
Vibration withstand acc. to IEC 60068-2-6		5...300 Hz						(2)

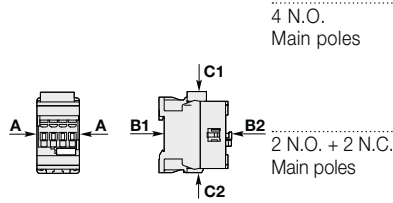

(1) Environment B: all AF09 ... AF38 contactors produced since week 08-2013. AF09 ... AF38-...-12 (48...130 V 50/60 Hz-DC) compliant to environment A only.
For environment B: select AF09 ... AF38-...-22.
(2) On request.

Remark for 4-pole contactors fitted with 2 N.O. + 2 N.C. main poles

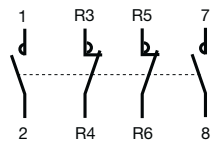

These contactors are suitable for controlling 2 separate circuits, i.e. 2 loads with 2 separate supplies, or 1 circuit comprising 2 separate loads with a single supply (see diagrams below). When the contactor operates there is no mechanical overlapping between the N.O. poles and the N.C. poles: BREAK before MAKE.



These contactors are not suitable for a reversing starter or for controlling a single load from 2 separate supplies.

Block diagrams

– Single supply and 2 separate loads

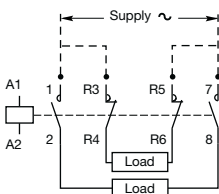

– 2 separate supplies and 2 separate loads

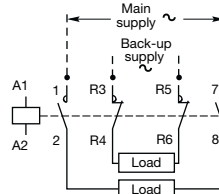

AF116 ... EK1000 4-pole contactors

Technical data

General technical data

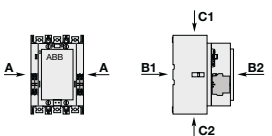
Contactor types	AC / DC operated	AF116	AF140	AF190	AF205	AF265	AF305	AF370
Rated insulation voltage U_i acc. to IEC 60947-4-1 acc. to UL / CSA		1000 V 600 V						
Rated impulse withstand voltage U_{imp}		8 kV						
Electromagnetic compatibility		AF contactors comply with IEC 60947-1 / EN 60947-1 - Environment A						
Ambient air temperature close to contactor								
Operation		-40 to +70 °C						
Storage		-40 to +70 °C						
Maximum operating altitude (without derating)		3000 m						
Mechanical durability								
Number of operating cycles		5 million operating cycles						
Maximum switching frequency		300 cycles/h						
Shock withstand acc. to IEC 60068-2-27 and EN 60068-2-27 Mounting position 1		No change in contact position, closed or open position						
	Shock direction	1/2 sinusoidal shock for 11 ms			1/2 sinusoidal shock for 30 ms			
	A	20 g			20 g			
	B1	15 g closed position / 3 g open position			15 g closed position / 3 g open position			
	B2	15 g closed position / 3 g open position			15 g closed position / 3 g open position			
	C1	20 g			20 g			
	C2	20 g			20 g			
Vibration withstand acc to IEC 60068-2-6		0.7 g closed position / 0.7 g open position 13.2...100 Hz						

5

General technical data

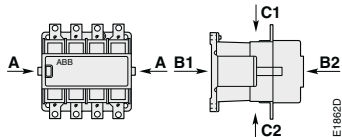
Contactor types	AC or DC operated	EK550	EK1000
Rated insulation voltage U_i acc. to IEC 60947-4-1 acc. to UL		1000 V 600 V	
Rated impulse withstand voltage U_{imp}		8 kV	
Electromagnetic compatibility		EK contactors complying with IEC 60947-1 / EN 60947-1 - Environment A	
Ambient air temperature close to contactor			
Operation	Fitted with thermal overload relay	-25 to +55 °C	-
	Without thermal overload relay	-40 to +70 °C	-
Storage		-50 to +70 °C	-
Climatic withstand		Category B acc. to IEC 60068-2-30	
Maximum operating altitude (without derating)		≤ 3000 m	
Mechanical durability			
Number of operating cycles		5 millions operating cycles	3 millions operating cycles
Max. switching frequency		60 cycles/h	
Shock withstand acc. to IEC 60068-2-27 and EN 60068-2-27 Mounting position 1 Closed or open position		1/2 sinusoidal shock for 15 ms: no change in contact position, closed or open position	
	Shock direction	1/2 sinusoidal shock for 15 ms: no change in contact position, closed or open position	
	A	10 g	
	B1	10 g	
	B2	10 g	
	C1	10 g	
	C2	10 g	

AF09 ... AF80 4-pole contactors

Technical data

Magnet system characteristics

Contactor types	AC / DC operated	AF09	AF16	AF26	AF38	AF40	AF52	AF80	
Coil operating limits acc. to IEC 60947-4-1	AC supply	At $\theta \leq 60^\circ\text{C}$ $0.85 \times U_c \text{ min} \dots 1.1 \times U_c \text{ max.}$ At $\theta \leq 70^\circ\text{C}$ $0.85 \times U_c \text{ min} \dots U_c \text{ max.}$				at $\theta \leq 70^\circ\text{C}$ $0.85 \times U_c \text{ min} \dots 1.1 \times U_c \text{ max}$			
	DC supply	At $\theta \leq 60^\circ\text{C}$ $0.85 \times U_c \text{ min} \dots 1.1 \times U_c \text{ max.}$ At $\theta \leq 70^\circ\text{C}$ (AF) $0.85 \times U_c \text{ min} \dots U_c \text{ max.}$ - (AF.Z) $0.85 \times U_c \text{ min} \dots 1.1 \times U_c \text{ max.}$				at $\theta \leq 70^\circ\text{C}$ $0.85 \times U_c \text{ min} \dots 1.1 \times U_c \text{ max}$			
AC control voltage 50/60 Hz									
Rated control circuit voltage U_c		24...500 V AC							
Coil consumption		Average pull-in value (AF) 50 VA - (AF.Z) 16 VA				40 VA			
		Average holding value (AF) 2.2 VA / 2 W - (AF.Z) 1.7 VA / 1.5 W				4 VA / 2 W			
DC control voltage									
Rated control circuit voltage U_c		12...500 V DC				20...500 V DC			
Coil consumption		Average pull-in value (AF) 50 W - (AF.Z) 12...16 W				40 W			
		Average holding value (AF) 2 W - (AF.Z) 1.7 W				2 W			
PLC-output control		(AF.Z) $\geq 500 \text{ mA}$ 24 V DC				-			
Drop-out voltage		$\leq 60\%$ of $U_c \text{ min.}$						$\leq 60\%$ of $U_c \text{ min.}$	
Voltage sag immunity acc. to SEMI F47-0706		(AF.Z) conditions of use on request				conditions of use on request			
Dips withstand $-20^\circ\text{C} \leq \theta \leq +60^\circ\text{C}$		(AF.Z) 22 ms average for $U_c \geq 24 \text{ V}$ 50/60 Hz or $U_c \geq 20 \text{ V}$ DC				24 ms average			
Operating time									
Between coil energization and:		N.O. contact closing		40...95 ms		(1)			
		N.C. contact opening		38...90 ms		(1)			
Between coil de-energization and:		N.O. contact opening		11...95 ms		(1)			
		N.C. contact closing		13...98 ms		(1)			

(1) On request.

Mounting characteristics and conditions for use

Contactor types	AF09	AF16	AF26	AF38	AF40	AF52	AF80
Mounting positions							
Mounting distances	Max. add-on N.C. auxiliary contacts: see accessory fitting details for a 4-pole contactor AF09 ... AF80						
Fixing	The contactors can be assembled side by side						
On rail according to IEC 60715, EN 60715	35 x 7.5 mm or 35 x 15 mm				35 x 15 mm		
By screws (not supplied)	2 x M4 screws placed diagonally				2 x M4 or 2 x M6 screws placed diagonally		

AF116 ... AF370 4-pole contactors

Technical data

Magnet system characteristics

Contactor types	AC / DC operated	AF116	AF140	AF190	AF205	AF265	AF305	AF370
Coil operating limits acc. to IEC 60947-4-1	AC supply	At $\theta \leq 70^\circ\text{C}$ $0.85 \times U_c \text{ min} \dots 1.1 \times U_c \text{ max}$						
	DC supply	At $\theta \leq 70^\circ\text{C}$ $0.80 \times U_c \text{ min} \dots 1.1 \times U_c \text{ max}$						
Rated control circuit voltage U_c		24...500 V AC, 20...500 V DC						
Coil consumption								
AC control voltage 50/60 Hz								
24...60 V AC	Average pull-in value	225 VA		165 VA		475 VA		
	Average holding value	5.5 VA		6 VA		8.5 VA		
48...130 V AC	Average pull-in value	170 VA		175 VA		340 VA		
	Average holding value	4 VA		4 VA		17 VA		
100...250 V AC	Average pull-in value	130 VA		220 VA		385 VA		
	Average holding value	6 VA		7 VA		17.5 VA		
250...500 V AC	Average pull-in value	205 VA		185 VA		420 VA		
	Average holding value	16 VA		16 VA		21 VA		
DC control voltage								
20...60 V DC	Average pull-in value	210 W		205 W		400 W		
	Average holding value	2.5 W		2.5 W		3.5 W		
48...130 V DC	Average pull-in value	130 W		130 W		360 W		
	Average holding value	2.5 W		2.5 W		2.5 W		
100...250 V DC	Average pull-in value	135 W		190 W		410 W		
	Average holding value	3 W		2.5 W		4.5 W		
250...500 V DC	Average pull-in value	205 W		190 W		600 W		
	Average holding value	4 W		4 W		4.7 W		
Drop-out voltage		55 % of $U_c \text{ min}$						
Voltage sag immunity acc. to SEMI F47		Conditions of use on request						
Dips withstand		$\geq 20 \text{ ms}$						
Operating time								
Coil supply between A1 - A2								
Between coil energization and:	N.O. contact closing	20...55 ms		25...60 ms		30...60 ms		
Between coil de-energization and:	N.O. contact opening	40...70 ms		45...80 ms		45...80 ms		

5

Mounting characteristics and conditions for use

Contactor types	AC / DC operated	AF116	AF140	AF190	AF205	AF265	AF305	AF370
Mounting positions								
Mounting distances		The contactors can be assembled side by side						
Fixing								
On rail acc. to IEC 60715, EN 60715		-						
By screws (not supplied)		4 x M5						

EK550 ... EK1000 4-pole contactors

Technical data

Magnet system characteristics

Contactor types		AC operated	EK550	EK1000
Coil operating limits		AC supply	At $\theta \leq 70^\circ\text{C}$ $0.85 \times U_c \text{ min} \dots 1.1 \times U_c \text{ max}$.	
acc. to IEC 60947-4-1			Please also refer to "Mounting characteristics and conditions for use"	
AC control voltage				
Rated control circuit voltage		50 Hz	48...500 V	
		60 Hz	110...600 V	
Coil consumption	Average pull-in value	50 Hz	3500 VA	
		60 Hz	4000 VA	
	Average holding value	50/60 Hz (1)	3800 / 3400 VA	
		50 Hz	125 VA / 50 W	
	60 Hz	140 VA / 60 W		
	50/60 Hz (1)	140 VA / 60 W		
Drop-out voltage in % of $U_c \text{ min}$.			approx. 45...65 %	
Operating time				
Between coil energization and:		N.O. contact closing	30...60 ms	
		N.C. contact opening	25...55 ms	
Between coil de-energization and:		N.O. contact opening	10...20 ms	
		N.C. contact closing	13...23 ms	

(1) "A" coil voltage: see "Coil voltage code table".

Magnet system characteristics

Contactor types		DC operated	EK550	EK1000
Coil operating limits		DC supply	At $\theta \leq 70^\circ\text{C}$ $0.85 \times U_c \text{ min} \dots 1.1 \times U_c \text{ max}$.	
acc. to IEC 60947-4-1			Please also refer to "Mounting characteristics and conditions for use"	
DC control voltage				
Rated control circuit voltage			24...220 V	
Coil consumption	Average pull-in value		1100 W	
	Average holding value		20 W	
Drop-out voltage			approx. 15...50 % of $U_c \text{ min}$.	
Coil time constant				
Open		L/R	12 ms	
Closed		L/R	60 ms	
Operating time				
Between coil energization and:		N.O. contact closing	60...80 ms	
		N.C. contact opening	55...75 ms	
Between coil de-energization and:		N.O. contact opening	10...35 ms	
		N.C. contact closing	13...38 ms	

Mounting characteristics and conditions for use

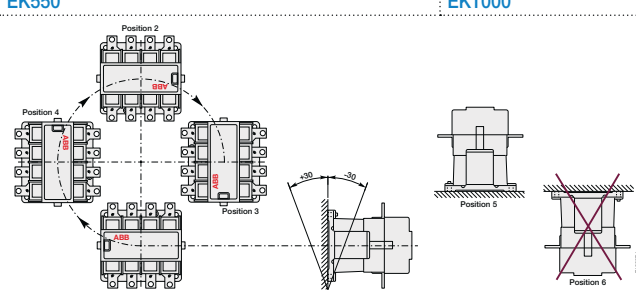









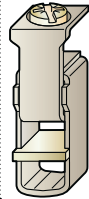
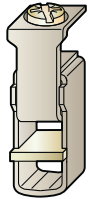
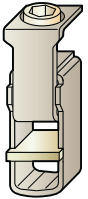



Contactor types		AC / DC operated	EK550	EK1000
Mounting positions				
Control voltage / Ambient temperature			Max. N.O. or N.C. built-in and add-on N.O. or N.C. auxiliary contacts: see accessory fitting details for 4-pole contactor EK550, EK1000	
Mounting positions	1, $1 \pm 30^\circ$, 2, 3, 4, 5	at $\theta \leq 70^\circ\text{C}$	$0.85 \dots 1.1 \times U_c$	
	6	at $\theta \leq 70^\circ\text{C}$	Unauthorized	
Mounting distances			The contactors can be assembled side by side	
Fixing				
On rail according to IEC 60715, EN 60715			-	
By screws (supplied)			4 x M6 (2)	

(2) Damping elements are supplied.

AF09 ... AF80 4-pole contactors

Technical data

Connecting characteristics

Contactor types	AF09	AF16	AF26	AF38	AF40	AF52	AF80
Main terminals							
	Screw terminals with cable clamp		Screw terminals with double connector 2 x (5.5 width x 6.8 depth)		Screw terminals with double connector 2 x (9.3 width x 7.9/10.3 depth)		Screw terminals with double connector 2 x (12.4 width x 9.3/11.1 depth)
Connection capacity (min. ... max.)							
Main conductors (poles)							
 Rigid	Solid ($\leq 4 \text{ mm}^2$)	} 1 x	1...6 mm ²	1.5...16 mm ²	6...35 mm ²	6...70 mm ²	
 Stranded ($\geq 6 \text{ mm}^2$)			2 x	1...6 mm ²	1.5...16 mm ²	6...35 mm ²	6...50 mm ²
 Flexible with non insulated ferrule		1 x	0.75...6 mm ²	1.5...16 mm ²	4...35 mm ²	6...50 mm ²	
 Flexible with insulated ferrule		2 x	0.75...6 mm ²	1.5...16 mm ²	4...35 mm ²	6...50 mm ²	
 Flexible with insulated ferrule		1 x	0.75...4 mm ²	1.5...16 mm ²	4...35 mm ²	6...50 mm ²	
 Flexible with insulated ferrule		2 x	0.75...2.5 mm ²	1.5...16 mm ²	4...35 mm ²	6...50 mm ²	
 Bars or lugs		L <	9.6 mm	-	9.2 mm	12.2 mm	
Connection capacity acc. to UL/CSA	1 or 2 x		AWG 16...10	AWG 16...6	AWG 10...2	AWG 6...1	
Stripping length			10 mm	12 mm	16 mm	17 mm	
Tightening torque			1.5 Nm / 13 lb.in	2.5 Nm / 22 lb.in	4 Nm / 35 lb.in	6 Nm / 53 lb.in	
Auxiliary conductors (coil terminals)							
 Rigid solid		1 x	1...2.5 mm ²				
 Rigid solid		2 x	1...2.5 mm ²				
 Flexible with non insulated ferrule		1 x	0.75...2.5 mm ²				
 Flexible with non insulated ferrule		2 x	0.75...2.5 mm ²				
 Flexible with insulated ferrule		1 x	0.75...2.5 mm ²				
 Flexible with insulated ferrule		2 x	0.75...1.5 mm ²				
 Lugs		L <	8 mm				
Connection capacity acc. to UL/CSA	1 or 2 x		AWG 18...14				
Stripping length			10 mm				
Tightening torque			1.2 Nm / 11 lb.in				
Degree of protection acc. to IEC 60947-1 / EN 60947-1 and IEC 60529 / EN 60529							
Main terminals	IP20				IP10		
Coil terminals	IP20						
Screw terminals	Delivered in open position, screws of unused terminals must be tightened						
Main terminals	M3.5		M4.5		M6		M8
	Screwdriver type		Flat Ø 5.5 / Pozidriv 2		Flat Ø 6.5 / Pozidriv 2		hexagon socket (s = 4 mm)
Coil terminals			M3.5				
	Screwdriver type		Flat Ø 5.5 / Pozidriv 2				

AF116 ... AF370 4-pole contactors

Technical data

Connecting characteristics

Contactor types	AC / DC operated	AF116	AF140	AF190	AF205	AF265	AF305	AF370
Main terminals								
Flat type								
Connection capacity (min. ... max.)								
Main conductors (poles)								
	Cu cable - Stranded	1 x	10...95 mm ²	6...150 mm ²		16...300 mm ²		
	Clamp type		LD... included (1)	1SDA066917R1		1SDA055016R1		
	Tightening torque		8 Nm	14 Nm		25 Nm		
	Cu cable - Stranded	2 x	10...95 mm ²	50...120 mm ²		70...185 mm ²		
	Clamp type		LD... included (1)	1SFN074709R1000, LZ185-2C/120		1SCA022194R0890, OZXB4		
	Tightening torque		8 Nm	16 Nm		22 Nm		
	Al cable - Stranded	1 x	-	95...185 mm ²		185...240 mm ²		
	Clamp type		-	1SDA054988R1		1SDA055020R1		
	Tightening torque		-	31 Nm		43 Nm		
	Cu cable - Flexible	1 x	10...70 mm ²	6...120 mm ²		16...240 mm ²		
	Clamp type		LD... included (1)	1SDA066917R1		1SDA055016R1		
	Tightening torque		8 Nm	14 Nm		25 Nm		
	Cu cable - Flexible	2 x	10...70 mm ²	50...95 mm ²		70...185 mm ²		
	Clamp type		LD... included (1)	1SFN074709R1000, LZ185-2C/120		1SCA022194R0890, OZXB4		
	Tightening torque		8 Nm	16 Nm		22 Nm		
	Lugs	L ≤	22 mm (.866 in)	24 mm (.945 in)		32 mm (1.260 in)		
		Ø >	6 mm (.236 in)	8 mm (.315 in)		10 mm (.394 in)		
	Socket type		LL... included	LL... included		LL... included		
	Tightening torque		9 Nm / 80 lb.in	18 Nm / 160 lb.in		28 Nm / 248 lb.in		
	Connection capacity acc. to UL / CSA	1 x	AWG 6...3/0	6...300 MCM		4...400 MCM		
	Clamp type		LD... included (1)	ATK185 (2)		ATK300 (2)		
	Tightening torque		8 Nm / 71 lb.in	34 Nm / 301 lb.in		42 Nm / 372 lb.in		
	Connection capacity acc. to UL / CSA	2 x	AWG 6...3/0	-		4...500 MCM		
	Clamp type		LD... included (1)	-		ATK300/2 (2)		
	Tightening torque		8 Nm / 71 lb.in	-		42 Nm / 372 lb.in		
Auxiliary conductors								
(coil terminals)								
	Solid / stranded	1 x	1...4 mm ²					
		2 x	1...4 mm ²					
	Flexible	1 x	0.75...2.5 mm ²					
		2 x	0.75...2.5 mm ²					
	Flexible with non insulated ferrule	1 x	0.75...2.5 mm ²					
		2 x	0.75...2.5 mm ²					
	Flexible with insulated ferrule	1 x	0.75...2.5 mm ²					
		2 x	0.75...2.5 mm ²					
	Lugs	L <	8 mm					
		l >	3.5 mm					
	Connection capacity acc. to UL / CSA	1 or 2 x	AWG 18...14					
	Stripping length		9 mm					
	Tightening torque		1.00 Nm / 9 lb.in					
Degree of protection								
acc. to IEC 60947-1 / EN 60947-1 and IEC 60529 / EN 60529								
	Main terminals		IP00					
	Coil terminals		IP20					
Screw terminals								
	Main terminals		M6	M8	M10			
		Screwdriver type	Screws and bolts					
	Coil terminals (delivered in open position)		M3.5					
		Screwdriver type	Flat Ø 5.5 mm / Pozidriv 2					







(1) LD... not included for AF116 ... AF146-30...B.

(2) Available in North America only.

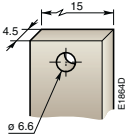
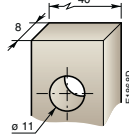
EK550 ... EK1000 4-pole contactors

Technical data

Connecting characteristics

Contactor types	AC or DC operated	EK550	EK1000
Main terminals Flat type			
Connection capacity (min. ... max.)			
Main conductors (poles)			
 Rigid with connector	Cu cable	1 x 70...300 mm ²	-
	Al/Cu cable	1 x 70...300 mm ²	95...300 mm ²
	Al/Cu cable	2 x 35...185 mm ²	95...300 mm ²
 Bars or lugs		L ≤ 55 mm	
		Ø > 10 mm	
Connection capacity acc. to UL/CSA	1 or 2 x	3 x 4 - 500 MCM	-
Tightening torque	Recommended	18 Nm / 160 lb.in	
	Max.	22 Nm	
Auxiliary conductors (coil terminals)			
 Rigid solid		1 x 0.5...2.5 mm ²	
		2 x 0.5...2.5 mm ²	
 Flexible with ferrule		1 x 0.5...2.5 mm ²	
		2 x 0.5...2.5 mm ²	
 Bars or lugs		L ≤ 8 mm	
		L > 3.7 mm	
Connection capacity acc. to UL/CSA	1 or 2 x	18...14 AWG	
Tightening torque	Recommended	1.00 Nm / 9 lb.in	
	Max.	1.20 Nm	
Degree of protection acc. to IEC 60947-1 / EN 60947-1 and IEC 60529 / EN 60529			
Main terminals		IP00	
Coil terminals		IP20	
Screw terminals			
Main terminals		M10	
		Screws and bolts	
Coil terminals (delivered in open positions)		M3.5	
	Screwdriver type	Flat Ø 5.5 mm / Pozidriv 2	

4-pole contactors

Electrical durability and utilization categories

General

Utilization categories determine the current making and breaking conditions relating to the characteristics of the loads to be controlled by the contactors. International standard IEC 60947-4-1 and European standard EN 60947-4-1 are the standards to be referred to.

If I_c is the current to be broken by the contactor and I_e the rated operational current normally drawn by the load, then:

- Categories AC-1: $I_c = I_e$

Generally speaking $I_c = m \times I_e$ where m is a multiple of the load operational current.

On next pages, the curves corresponding to categorie AC-1 represent the electrical durability variation of standard contactors in relation to the breaking current I_c .

Electrical durability curves:

- categories AC-1: the curves represent the electrical durability variation of standard contactors in relation to the breaking current I_c .

Electrical durability is expressed in millions of operating cycles.

5

Curve utilization mode

Electrical durability forecast and contactor selection for categories AC-1

- Note the characteristics of the load to be controlled:
 - Operational voltage U_e
 - Current normally drawn I_e (U_e / I_e / kW relation for motors, see "Motor rated operational powers and currents").
 - Utilization category AC-1
 - Breaking current $I_c = I_e$ for AC-1
- Define the number of operating cycles N required.
- On the diagram corresponding to the operational category, select the contactor with the curve immediately above the intersection point ($I_c ; N$).

Case of uninterrupted duty

For uninterrupted duty, some verifications of preventing maintenance are necessary to check the functionality of the concerned product (consult us).

The combined effect of environmental conditions and the proper temperature of the product may require some disposals. As a matter of fact, for this duty, the use duration prevails over the number of operating cycles.

4-pole contactors

Electrical durability

Electrical durability for AC-1 utilization category - $U_e \leq 690\text{ V}$

Switching non-inductive or slightly inductive loads. The breaking current I_c for AC-1 is equal to the rated operational current of the load.

Ambient temperature and maximum electrical switching frequency: see "Technical data".

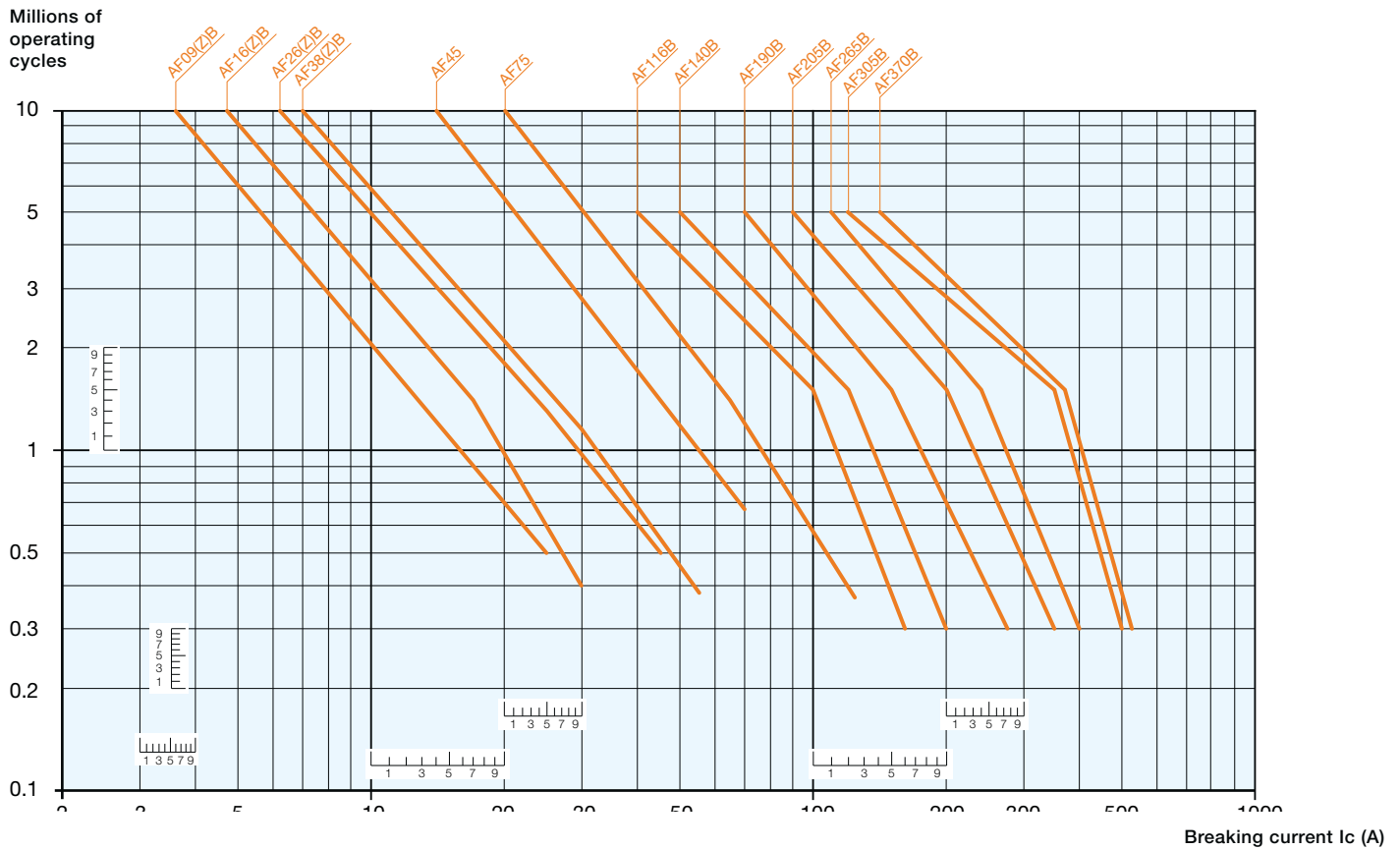

AF09 ... AF80 4-pole contactors

Terminal marking and positioning

AF09 ... AF38 contactors - AC / DC operated

Standard devices without addition of auxiliary contacts

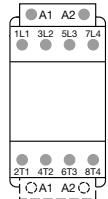

AF09 ... AF80...-40-00

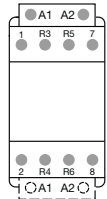

AF09 ... AF40...-22-00
AF80-22-00

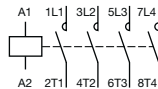

AF09 ... AF80...-40-00

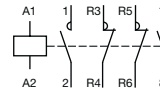

AF09 ... AF40...-22-00
AF80-22-00

Other possible contact combinations with auxiliary contacts added by the user

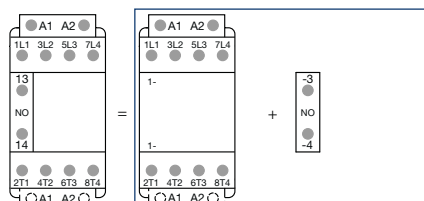

Combination 10 = AF09 ... AF80...-40-00 + CA4-10

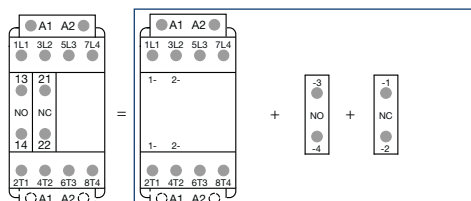

Combination 11 = AF09 ... AF80...-40-00 + CA4-10 + CA4-01

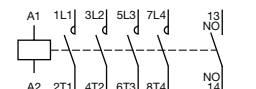

Combination 10

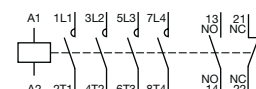

Combination 11

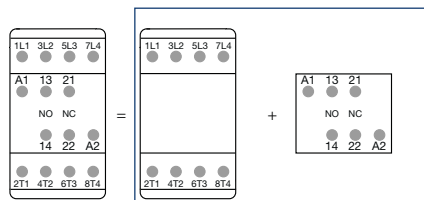

Combination 11 = AF09 ... AF80...-40-00 + CAT4-11E

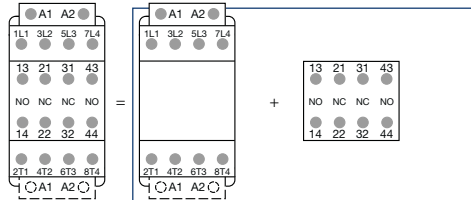

Combination 22 = AF09 ... AF80...-40-00 + CA4-22E

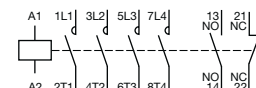

Combination 11

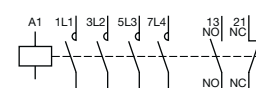

Combination 22

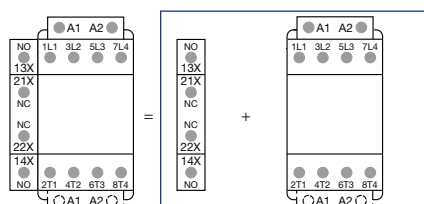

Combination 11 = CAL4-11 + AF09 ... AF80...-40-00

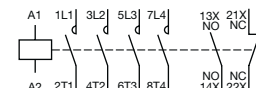

Combination 11

Note: Only AF09..Z ... AF38..Z contactor with DC control voltage 12...20 V DC need to respect the connection polarities indicated close to the coil terminals: A1+ for the positive pole and A2- for the negative pole

AF116 ... AF370 4-pole contactors

Terminal marking and positioning

AF116 ... AF370 contactors - AC / DC operated

Standard devices without addition of auxiliary contacts

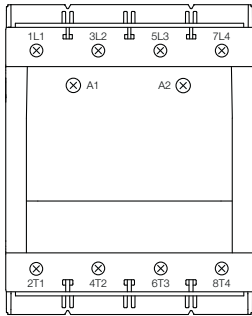

AF116 ... AF370-40-00

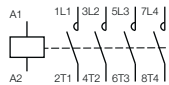

AF116 ... AF370-40-00

Standard devices with factory mounted auxiliary contacts

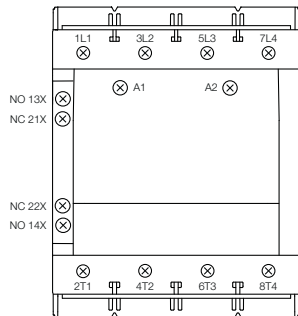

AF116 ... AF370-40-11

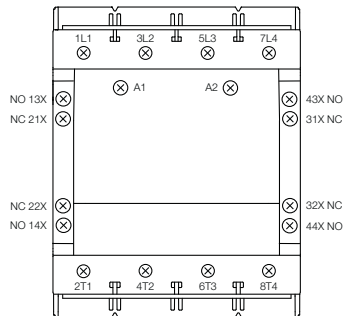

AF116 ... AF370-40-22

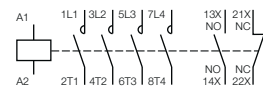

AF116 ... AF370-40-11

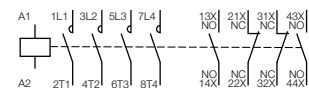

AF116 ... AF370-40-22

EK 4-pole contactors

Terminal marking and positioning

EK550, EK1000 contactors - AC operated

Standard devices

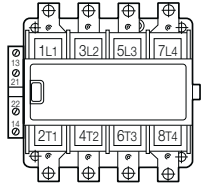

EK550, EK1000-40-11

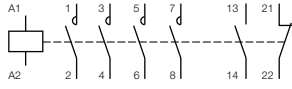

EK550, EK1000-40-11

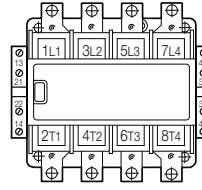

EK550, EK1000-40-22

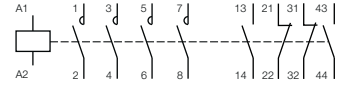

EK550, EK1000-40-22

Other possible contact combinations with auxiliary contacts added by the user

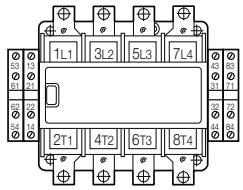

Combination 44

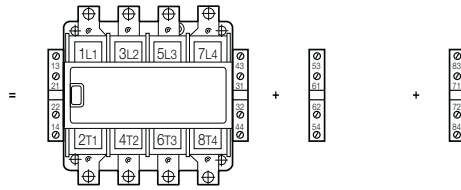

= EK550, EK1000-40-22 + CAL16-11C + CAL16-11D

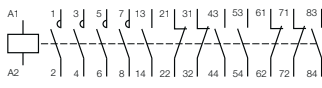

Combination 44

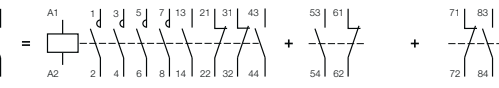

= EK550, EK1000-40-22 + CAL16-11C + CAL16-11D

EK550, EK1000 contactors - with multifrequency coil or DC operated

Standard devices

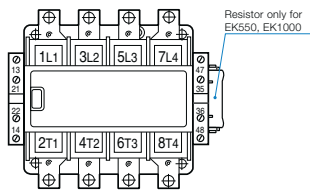

EK550, EK1000-40-21

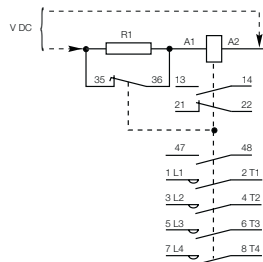

EK550, EK1000 DC operated

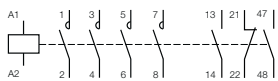

EK550, EK1000-40-21

Other possible contact combinations with auxiliary contacts added by the user

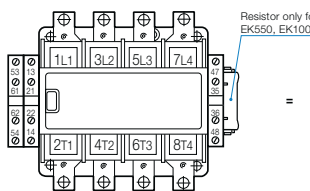

Combination 32

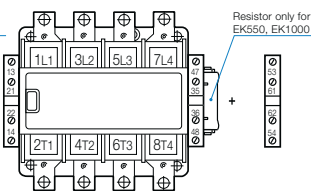

= EK550, EK1000-40-21 + CAL16-11C

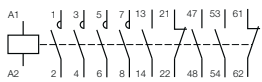

Combination 32

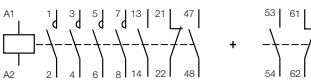

= EK550, EK1000-40-21 + CAL16-11C

AF09, AF16 4-pole contactors

Main dimensions mm, inches

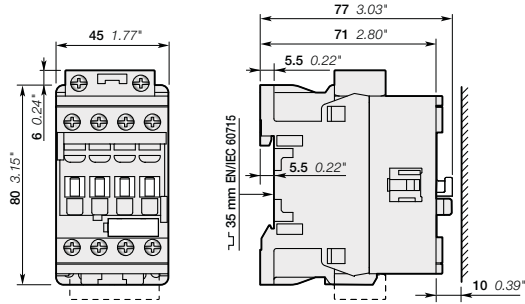

AF09, AF16

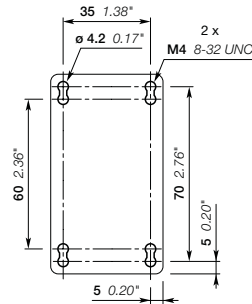

AF09, AF16

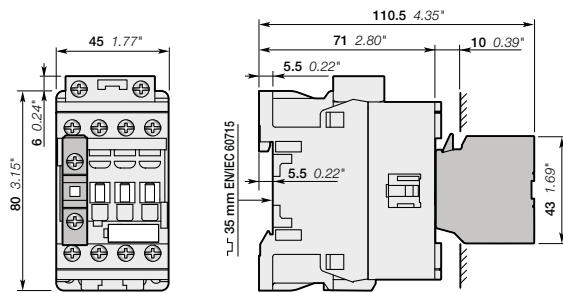

AF09, AF16
+ CA4, CC4 1-pole auxiliary contact block

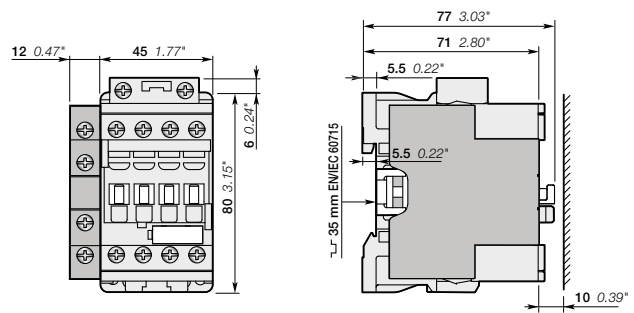

AF09, AF16
+ CAL4-11 2-pole auxiliary contact block

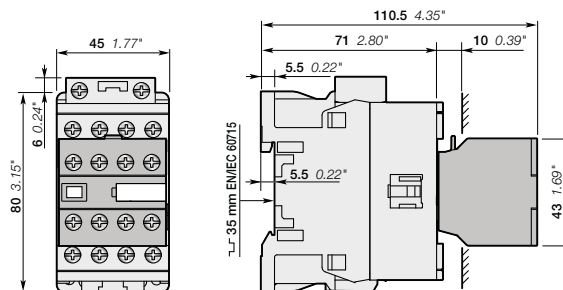

AF09, AF16
+ CA4 4-pole auxiliary contact block

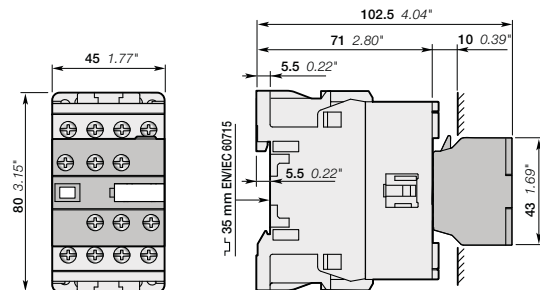

AF09, AF16
+ CAT4 2-pole auxiliary contact and coil terminal block

Note: contactor lateral distance to grounded component 2 mm 0.08 inches min.

AF09, AF16 4-pole contactors

Main dimensions mm, inches

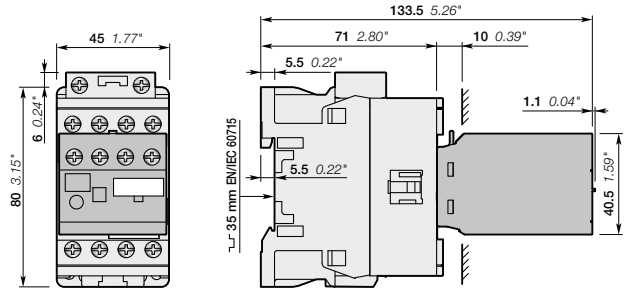

AF09, AF16
+ TEF4 electronic timer

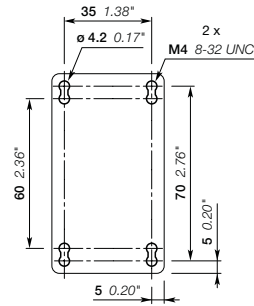

AF09, AF16

5

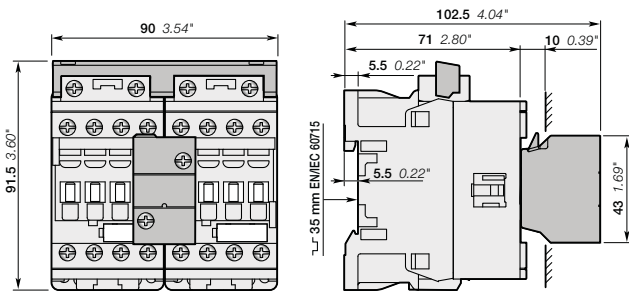

AF09..-40-00, AF16..-40-00
+ VEM4 mechanical and electrical interlock set

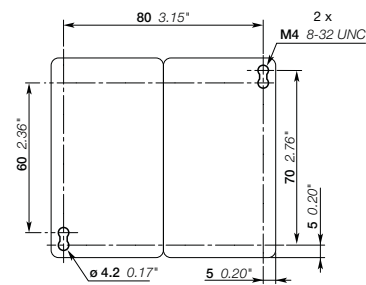

AF09..-40-00, AF16..-40-00
+ VEM4 mechanical and electrical interlock set

Note: contactor lateral distance to grounded component 2 mm 0.08" min.

AF26, AF38 4-pole contactors

Main dimensions mm, inches

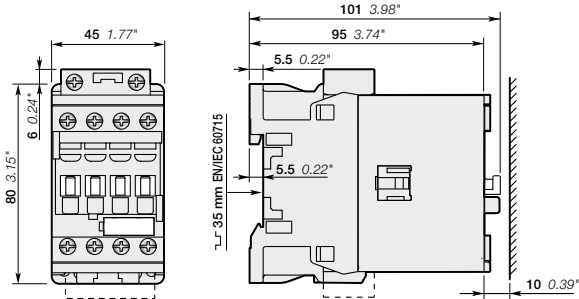

AF26, AF38

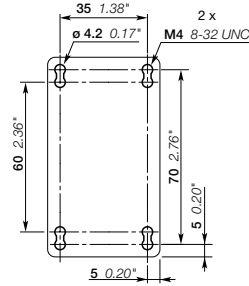

AF26, AF38

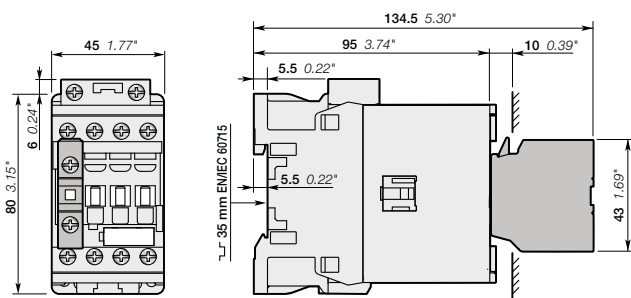

AF26, AF38
+ CA4, CC4 1-pole auxiliary contact block

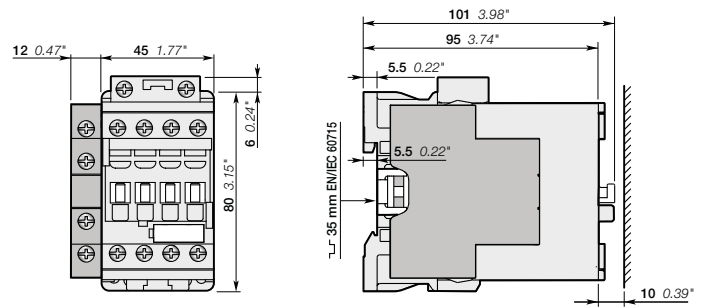

AF26, AF38
+ CAL4-11 2-pole auxiliary contact block

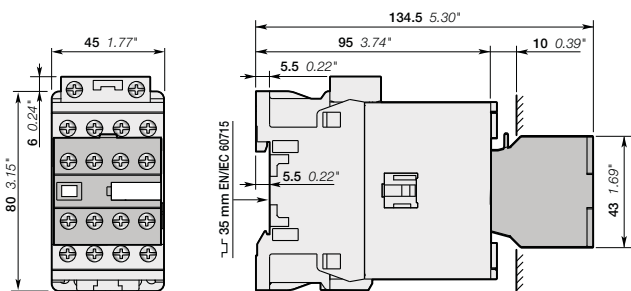

AF26, AF38
+ CA4 4-pole auxiliary contact block

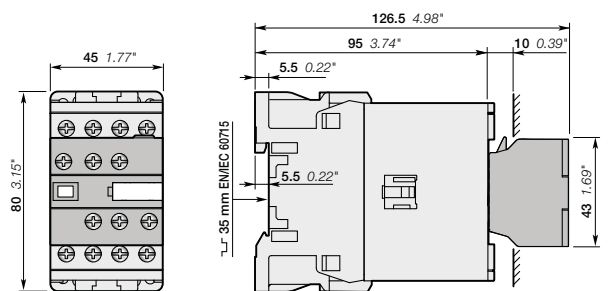

AF26, AF38
+ CAT4 2-pole auxiliary contact and coil terminal block

Note: contactor lateral distance to grounded component 2 mm 0.08 inches min.

AF26, AF38 4-pole contactors

Main dimensions mm, inches

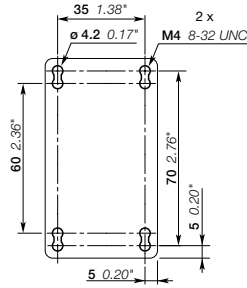
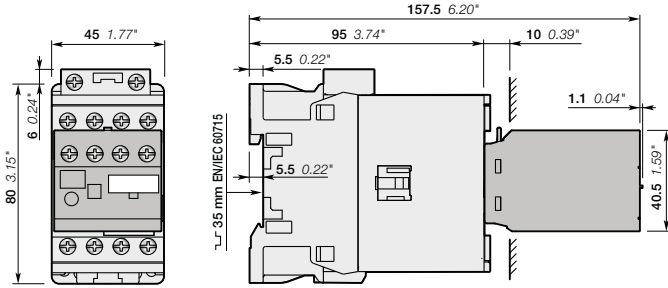

AF26, AF38
+ TEF4 electronic timer

AF26, AF38

5

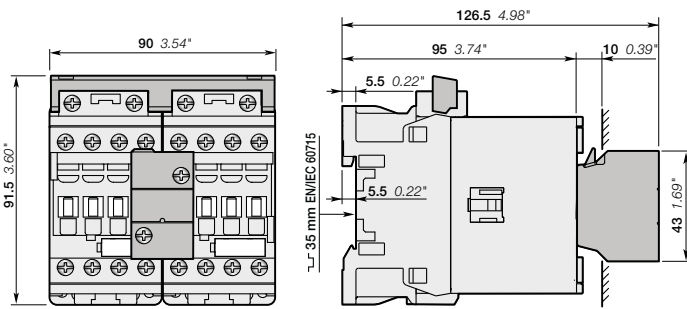

AF26..-40-00, AF38..-40-00
+ VEM4 mechanical and electrical interlock set

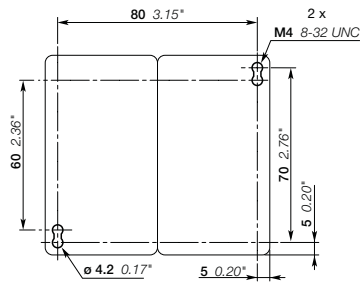

AF26..-40-00, AF38..-40-00
+ VEM4 mechanical and electrical interlock set

Note: contactor lateral distance to grounded component 2 mm 0.08" min.

AF40, AF52 4-pole contactors

Main dimensions mm, inches

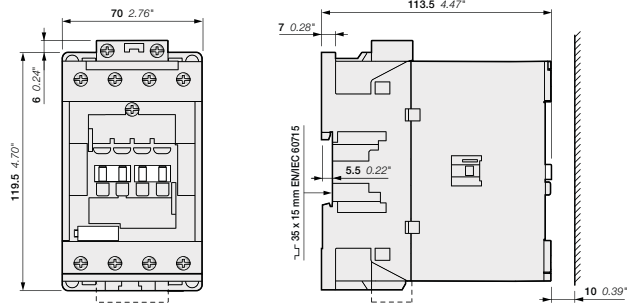

AF40, AF52

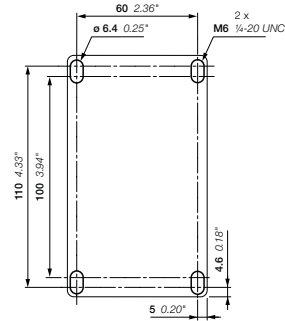

AF40, AF52

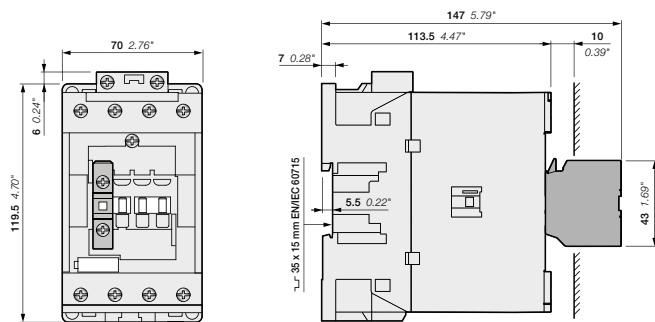

AF40, AF52
+ CA4, CC4 1-pole auxiliary contact block

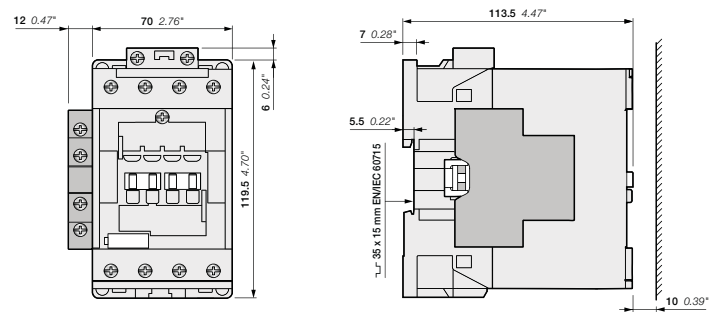

AF40, AF52
+ CAL4-11 2-pole auxiliary contact block

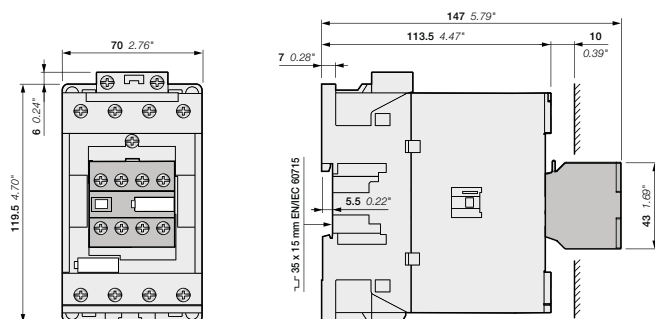

AF40, AF52
+ CA4 4-pole auxiliary contact block

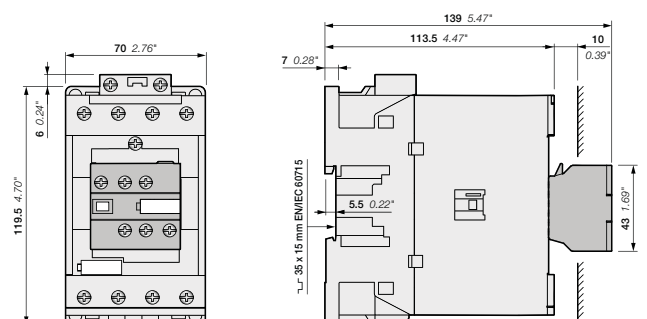

AF40, AF52
+ CAT4 2-pole auxiliary contact and coil terminal block

AF40, AF52 4-pole contactors

Main dimensions mm, inches

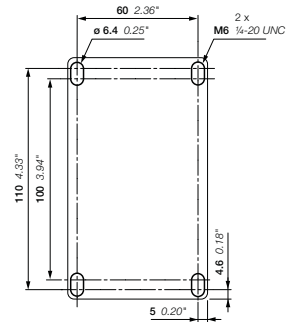
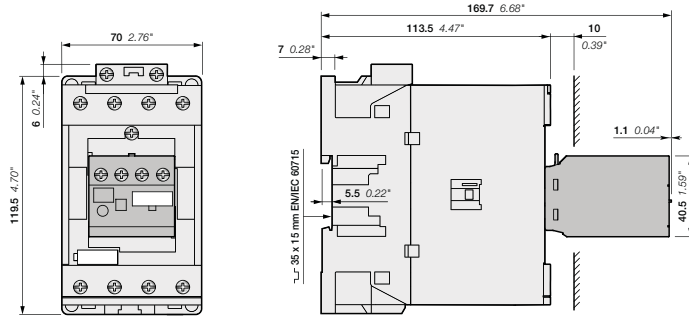

AF40, AF52

5

AF40, AF52
+ TEF4 electronic timer

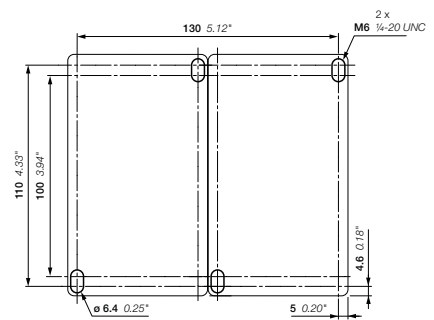
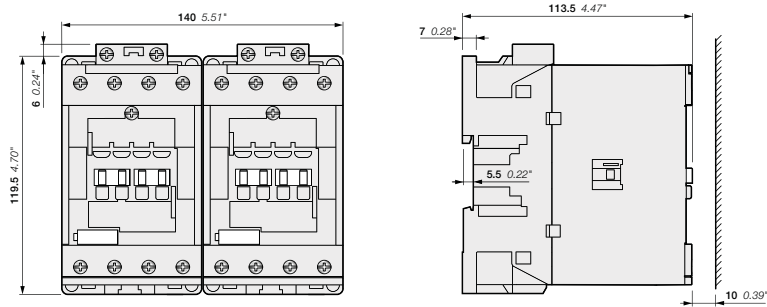

AF40, AF52
+ VM96-4 mechanical interlock unit

AF40, AF52
+ VM96-4 mechanical interlock unit

AF80 4-pole contactors

Main dimensions mm, inches

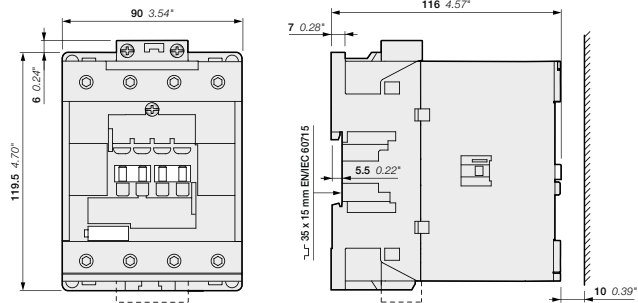

AF80

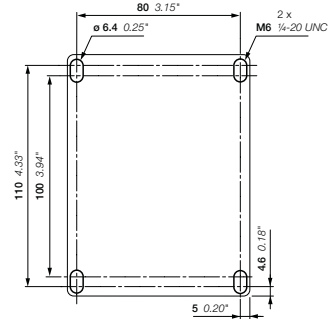

AF80

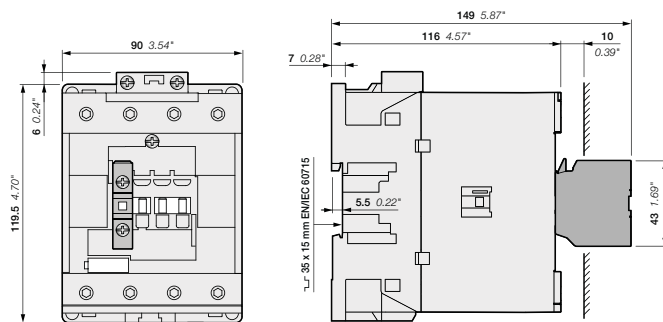

AF80
+ CA4, CC4 1-pole auxiliary contact block

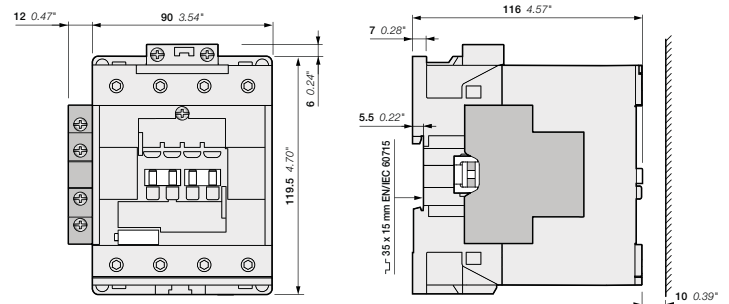

AF80
+ CAL4-11 2-pole auxiliary contact block

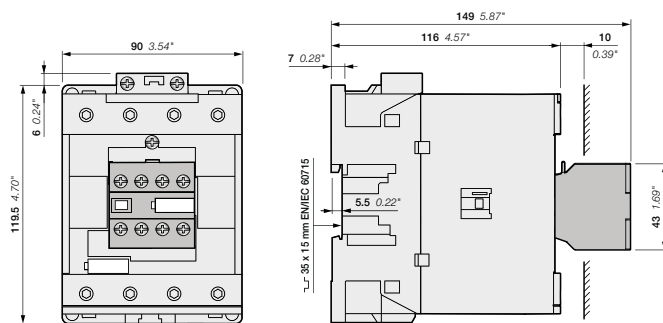

AF80
+ CA4 4-pole auxiliary contact block

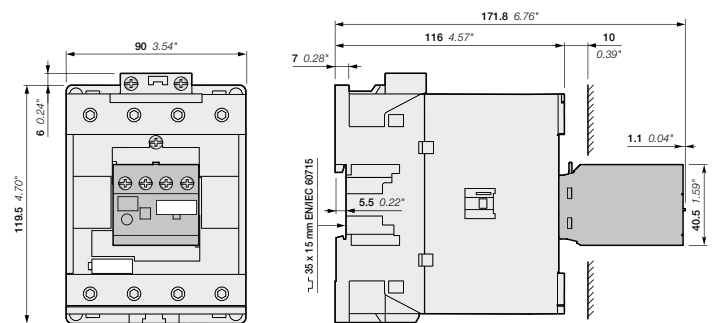

AF80
+ TEF4 Electronic timer

AF80 4-pole contactors

Main dimensions mm, inches

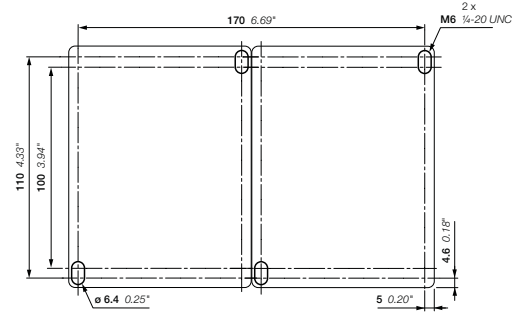
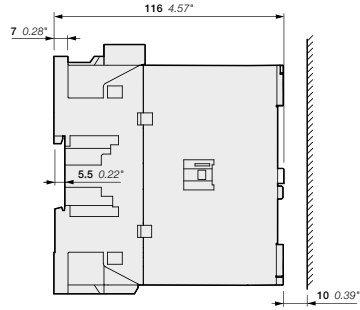
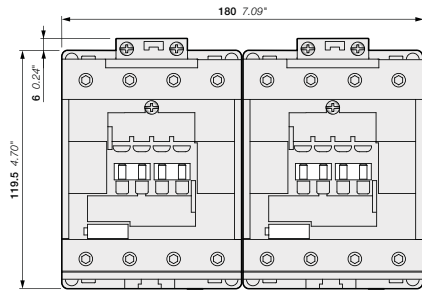

5

AF80
+ CA4, CC4 1-pole auxiliary contact block

AF80
+ VM96-4 mechanical interlock unit

AF116, AF140 4-pole contactors

Main dimensions mm, inches

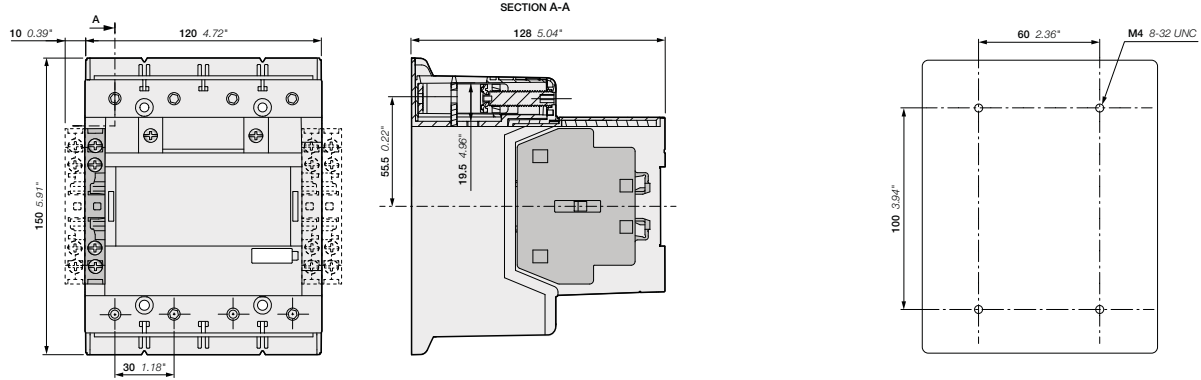

AF116, AF140-40-00 + CAL19 2-pole auxiliary contact block
AF116, AF140-40-11

AF116, AF140-40-..(B)

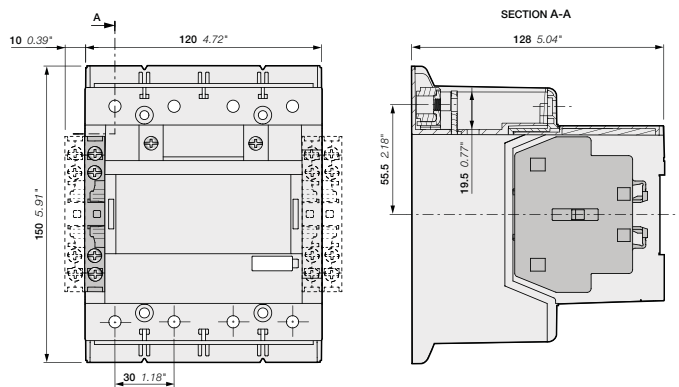

AF116, AF140-40-00B + CAL19 2-pole auxiliary contact block
AF116, AF140-40-11B

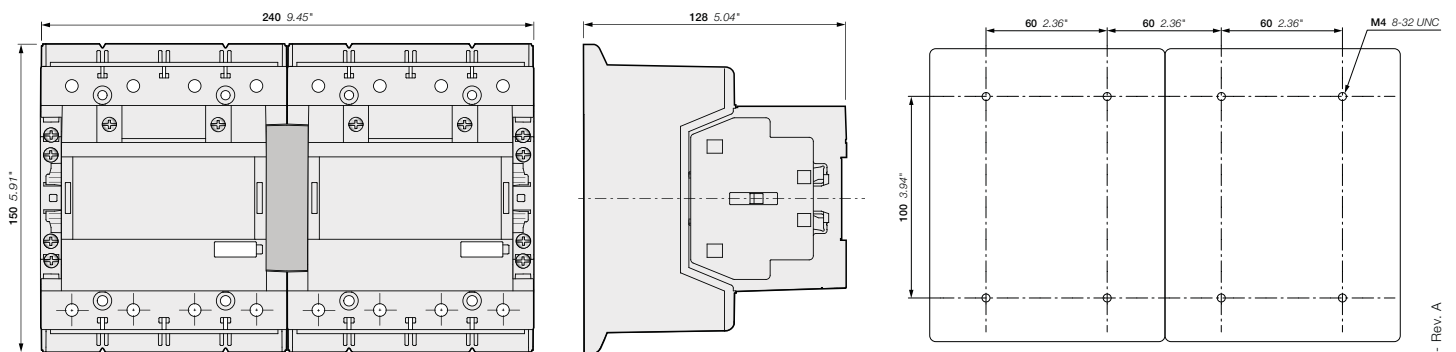

AF116, AF140-40-11
+ VM19 mechanical interlocking unit

AF116, AF140
+ VM19 mechanical interlocking unit

AF190, AF205 4-pole contactors

Main dimensions mm, inches

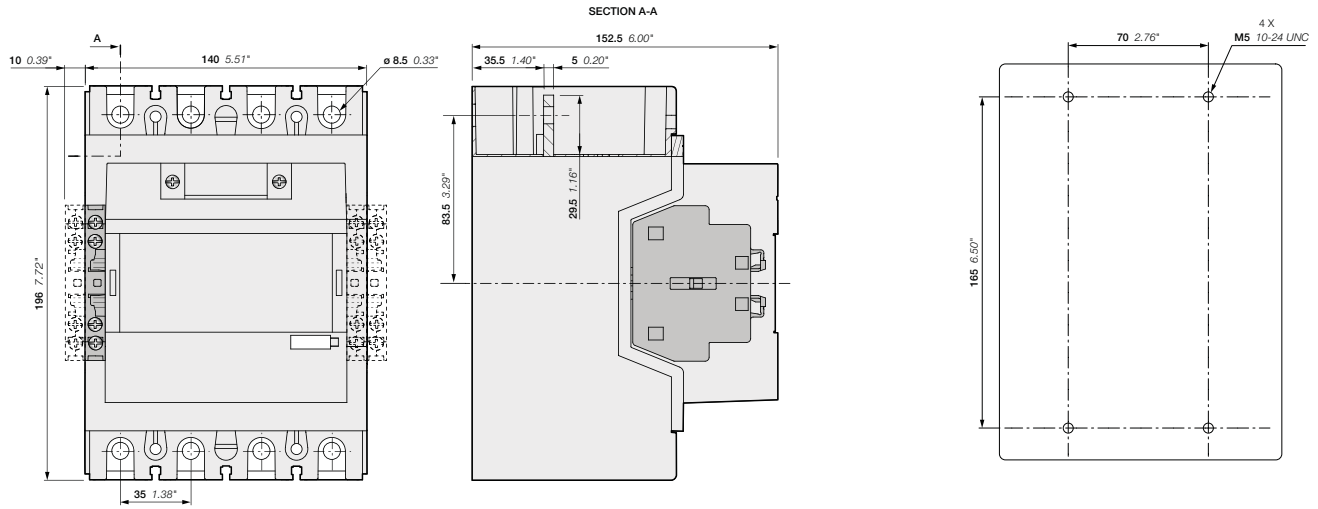

AF190, AF205-40-00 + CAL19 2-pole auxiliary contact block
AF190, AF205-40-11

AF190, AF205-40

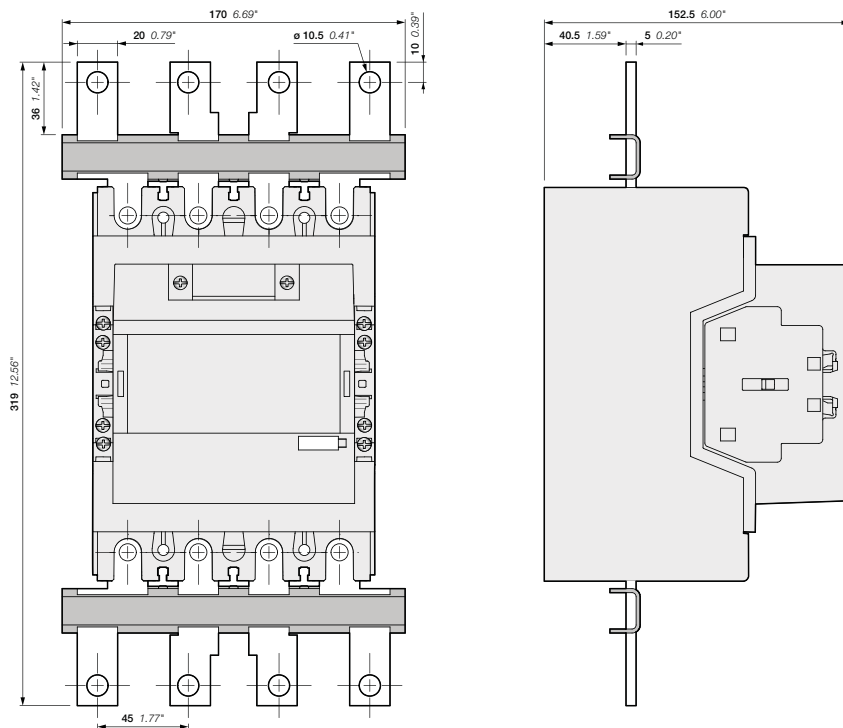

AF190, AF205-40-11
+ LW205-40 terminal enlargement

AF190, AF205 4-pole contactors

Main dimensions mm, inches

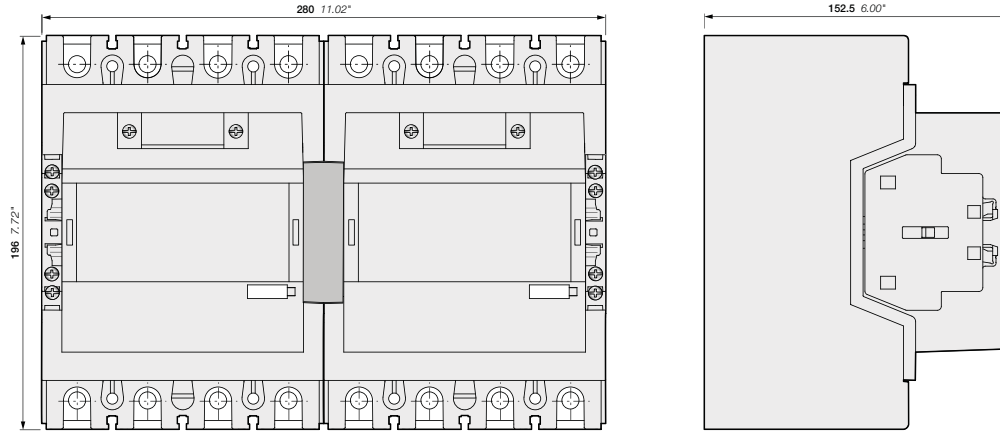

AF190, AF205-40-11
+ VM19 mechanical interlocking unit

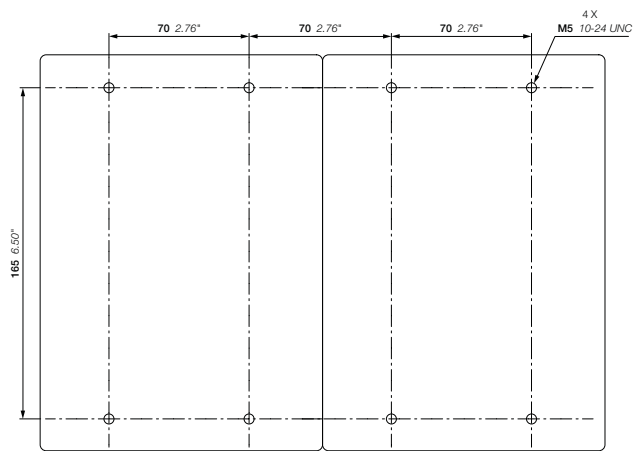

AF190, AF205
+ VM19 mechanical interlocking unit

AF265, AF305, AF370 4-pole contactors

Main dimensions mm, inches

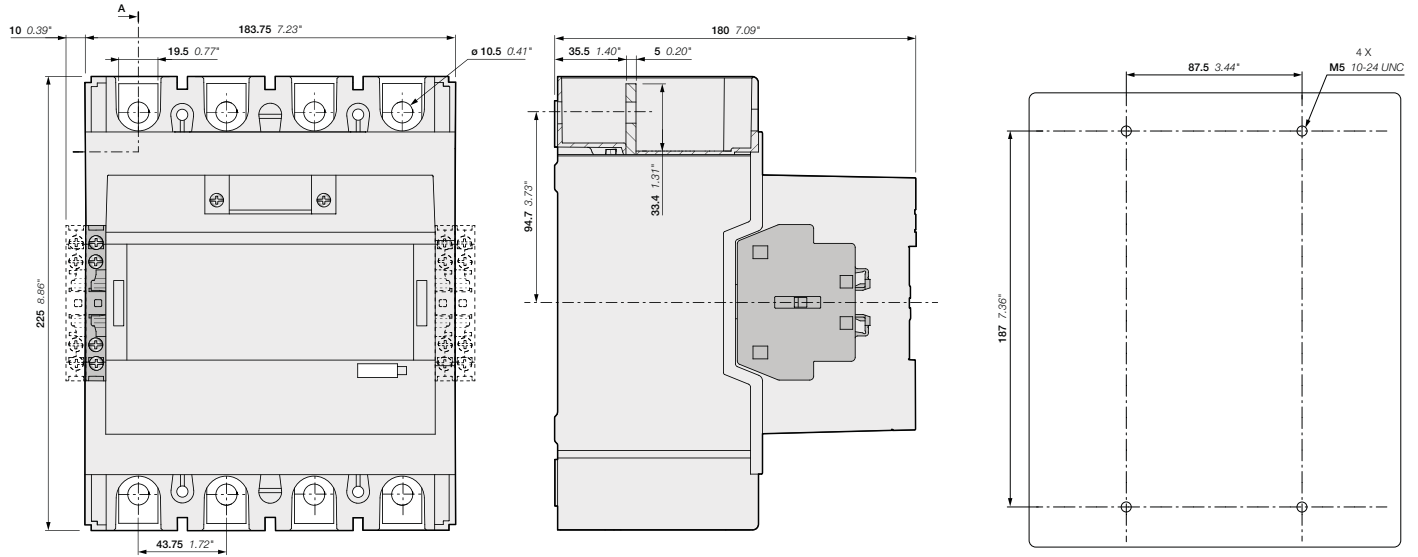

AF265, AF305, AF370-40-00 + CAL19 2-pole auxiliary contact block
AF265, AF305, AF370-40-11

AF265, AF305, AF370

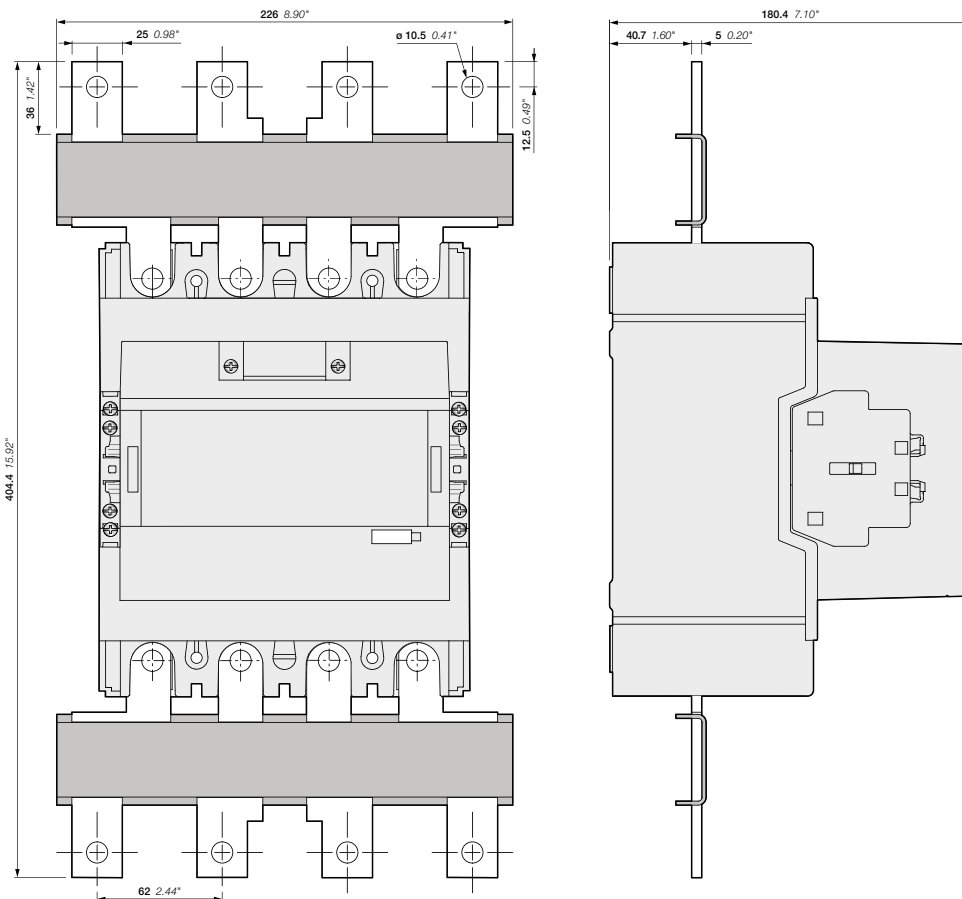

AF265, AF305, AF370-40-11
+ LW370-40 terminal enlargement

AF265, AF305, AF370 4-pole contactors

Main dimensions mm, inches

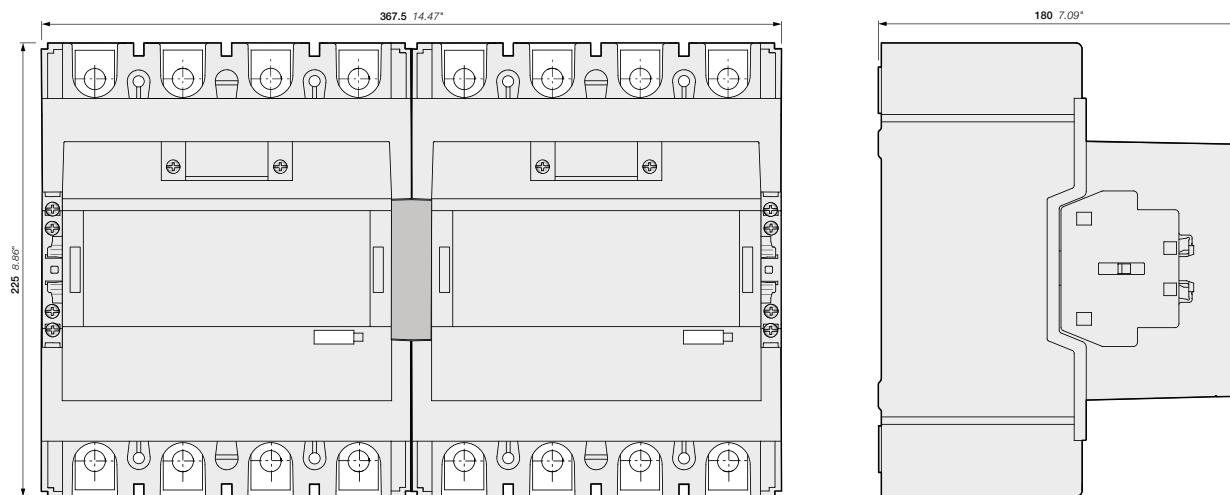

AF265, AF305, AF370-40-11
+ VM19 mechanical interlocking unit

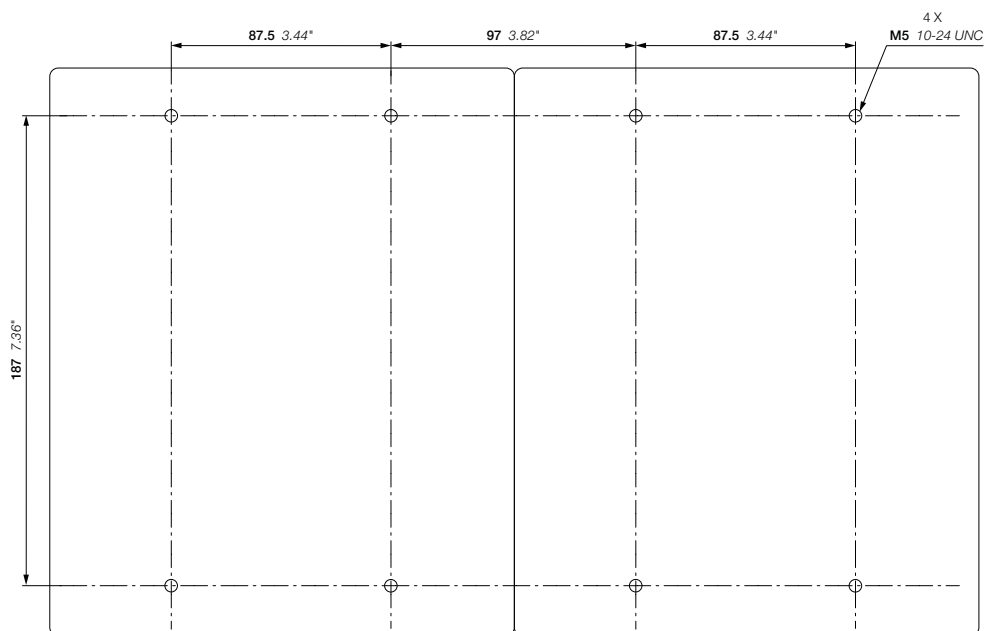

AF265, AF305, AF370
+ VM19 mechanical interlocking unit

EK550, EK1000 4-pole contactors

AC operated

Main dimensions mm, inches

5

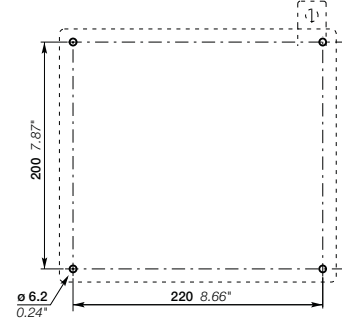
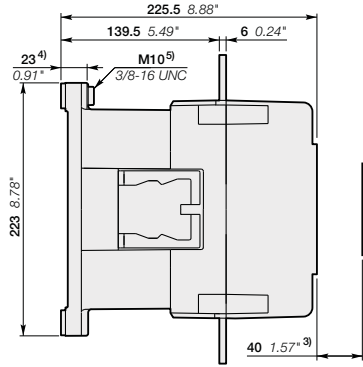
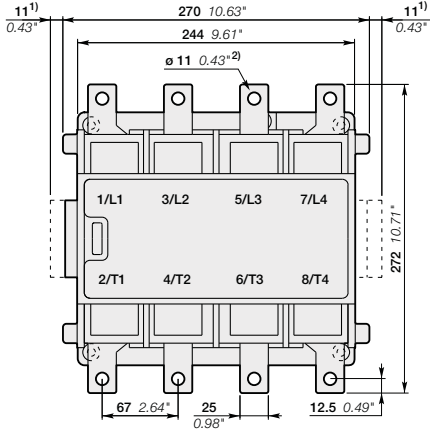

EK550

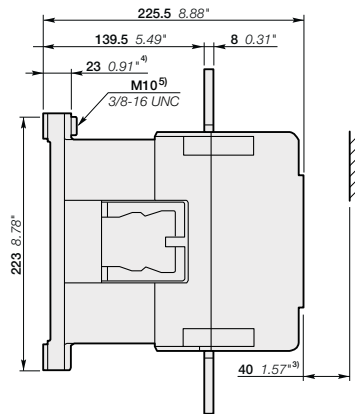
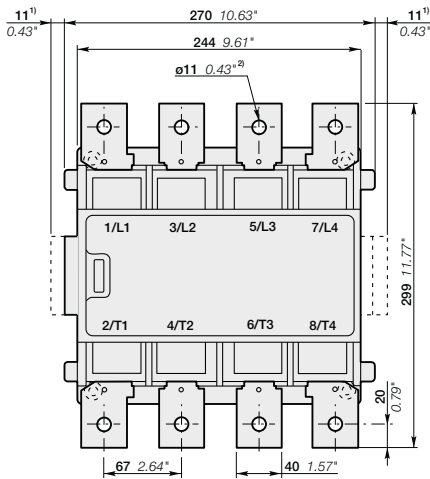

- 1) Dimension for extra auxiliary contact block
- 2) Screw, nut and washer by-packed
- 3) Min. distance to uninsulated wall
- 4) Damping elements are included
- 5) Earthing screw

EK1000

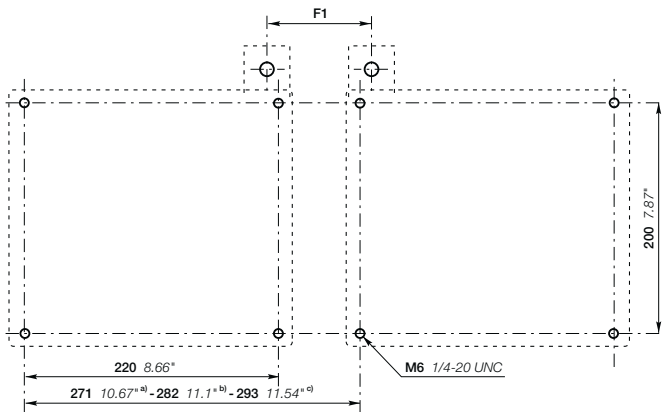

- a) Min. dim Makes distance F1 = 70
- b) Includes space for three auxiliary contact blocks between the contactors
- c) Includes space for four auxiliary contact blocks between the contactors

EK1000

EK550, EK1000 4-pole contactors

DC operated

Main dimensions mm, inches

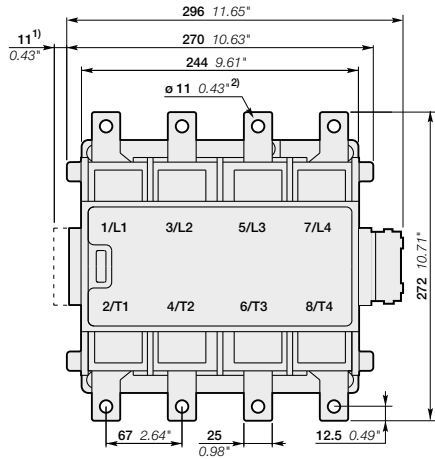

EK550

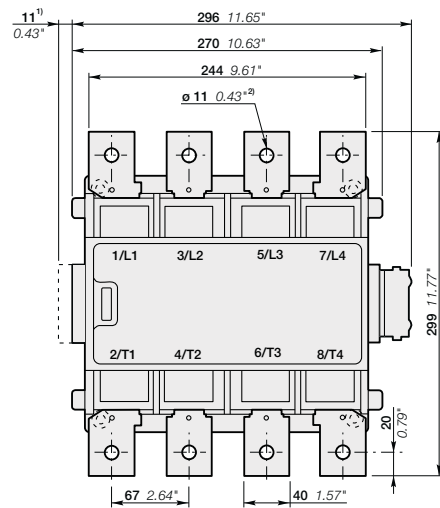
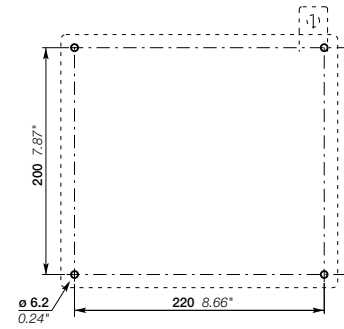
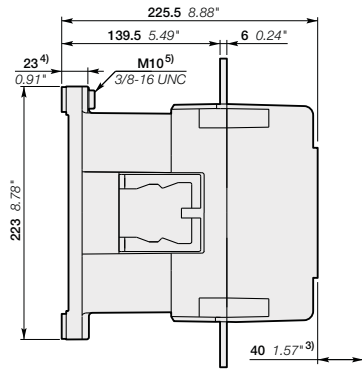

EK1000

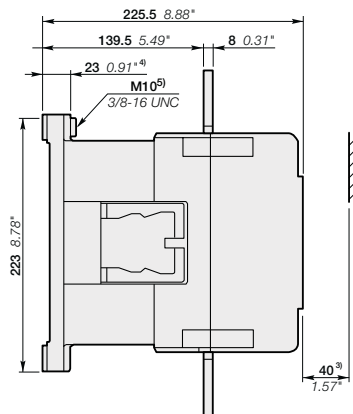

- 1) Dimension for extra auxiliary contact block
- 2) Screw, nut and washer by-packed
- 3) Min. distance to uninsulated wall
- 4) Damping elements are included
- 5) Earthing screw

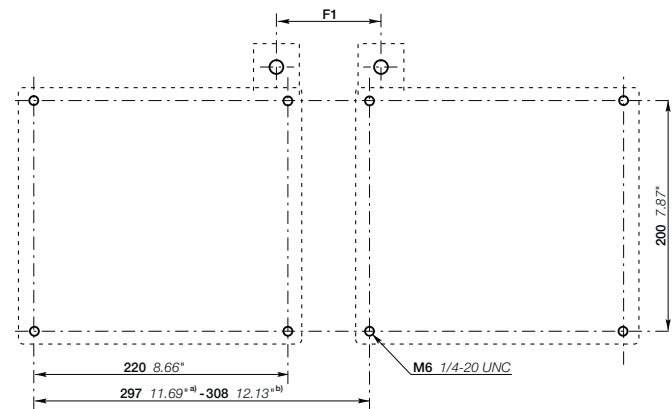

EK1000

- a) Min. dim.
- b) Includes space for two auxiliary contact blocks and the dc-unit between the contactors



Contactors for DC switching

[General description](#) [5/248](#)

[Selection table for DC switching](#)

AF09 ... AF96 contactors	5/248
AF116 ... AF2050 contactors	5/249
EK110 ... EK1000 contactors	5/250

[Ordering details](#)

100 A DC-1

GA75 AC operated	5/252
GAE75 DC operated	5/253

250 to 400 A DC-1

GAF185 ... GAF300 AC / DC operated	5/254
--	-----------------------

600 to 875 A DC-1

GAF460 ... GAF750 AC / DC operated	5/255
--	-----------------------

1040 to 1750 A DC-1

GAF1250 ... GAF2050 AC / DC operated	5/256
--	-----------------------

Main accessories	5/257
----------------------------------	-----------------------

[Technical data](#) [5/258](#)

[Terminal marking and positioning](#) [5/265](#)

[Main dimensions](#) [5/266](#)

[Voltage code table](#) [5/410](#)

AF09 ... AF96 contactors

DC circuit switching

General

The arc switching on DC is more difficult than on AC.







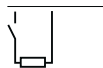

- For selecting a contactor it is essential to determine the current, the voltage and the L/R time constant of the controlled load
- For information, typical time constant values are quoted hereafter: non inductive loads such as resistance furnaces (L/R ≈ 1 ms), inductive loads such as shunt motors (L/R ≈ 2 ms) or series motors (L/R ≈ 7.5 ms)
- The addition of a resistor in parallel with an inductive winding helps in the elimination of the arcs
- All the poles required for breaking must be connected in series between the load and the source polarity not linked to earth (or chassis).

Technical data

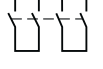
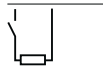
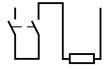
- The tables indicate for the standard contactors the I_e max. operating currents depending on: the utilization category (i.e. L/R) DC-1, DC-3, DC-5 as defined in the IEC 60947-4-1 publication, the operating voltage U_e and the pole coupling details.
Ampere values quoted in these tables are valid for a -25...+70 °C temperature close to the contactors, as long as these values do not exceed the AC-1 Ampere values for the corresponding ambient temperature
- Max. switching frequency: 300 cycles/h.

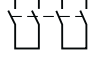
5

Selection table

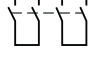
Contactor types	AF09	AF12	AF16	AF26	AF30	AF38	AF40	AF52	AF65	AF80	AF96			
	3 or 4-pole		3-pole	4-pole	3-pole	3-pole	4-pole	3-pole	3-pole	3-pole	3-pole			
Utilization category DC-1, L/R ≤ 1 ms														
	≤ 72 V	25 A	27 A	30 A	45 A	45 A	50 A	50 A	55 A	70 A	100 A	105 A	125 A	130 A
	110 V	10 A	15 A	20 A	-	-	-	-	-	-	-	-	-	-
	220 V	-	-	-	-	-	-	-	-	-	-	-	-	-
	≤ 72 V	25 A	27 A	30 A	45 A	45 A	50 A	50 A	55 A	70 A	100 A	105 A	125 A	130 A
	110 V	25 A	27 A	30 A	45 A	45 A	50 A	50 A	55 A	70 A	100 A	105 A	125 A	130 A
	220 V	10 A	15 A	20 A	-	-	-	-	-	-	-	-	-	-
	≤ 72 V	25 A	27 A	30 A	45 A	45 A	50 A	50 A	55 A	70 A	100 A	105 A	125 A	130 A
	110 V	25 A	27 A	30 A	45 A	45 A	50 A	50 A	55 A	70 A	100 A	105 A	125 A	130 A
	220 V	25 A	27 A	30 A	45 A	45 A	50 A	50 A	55 A	70 A	100 A	105 A	125 A	130 A
	≤ 72 V	25 A	-	30 A	-	45 A	-	-	55 A	-	-	-	-	-
	110 V	25 A	-	30 A	-	45 A	-	-	55 A	-	-	-	-	-
	220 V	25 A	-	30 A	-	45 A	-	-	55 A	-	-	-	-	-
	440 V	10 A	-	20 A	-	-	-	-	-	-	-	-	-	-
Utilization category DC-3, L/R ≤ 2 ms														
	≤ 72 V	25 A	27 A	30 A	45 A	-	50 A	50 A	-	70 A	100 A	105 A	125 A	130 A
	110 V	6 A	7 A	8 A	-	-	-	-	-	-	-	-	-	-
	220 V	-	-	-	-	-	-	-	-	-	-	-	-	-
	≤ 72 V	25 A	27 A	30 A	45 A	-	50 A	50 A	-	70 A	100 A	105 A	125 A	130 A
	110 V	25 A	27 A	30 A	45 A	-	50 A	50 A	-	70 A	100 A	105 A	125 A	130 A
	220 V	6 A	7 A	8 A	-	-	-	-	-	-	-	-	-	-
	≤ 72 V	25 A	27 A	30 A	45 A	-	50 A	50 A	-	70 A	100 A	105 A	125 A	130 A
	110 V	25 A	27 A	30 A	45 A	-	50 A	50 A	-	70 A	100 A	105 A	125 A	130 A
	220 V	25 A	27 A	30 A	45 A	-	50 A	50 A	-	70 A	100 A	105 A	125 A	130 A
	≤ 72 V	25 A	-	30 A	-	-	-	-	-	-	-	-	-	-
	110 V	25 A	-	30 A	-	-	-	-	-	-	-	-	-	-
	220 V	25 A	-	30 A	-	-	-	-	-	-	-	-	-	-
	440 V	6 A	-	8 A	-	-	-	-	-	-	-	-	-	-
Utilization category DC-5, L/R ≤ 7.5 ms														
	≤ 72 V	9 A	12 A	16 A	20 A	-	25 A	25 A	-	70 A	100 A	105 A	125 A	130 A
	110 V	4 A	4 A	4 A	-	-	-	-	-	-	-	-	-	-
	220 V	-	-	-	-	-	-	-	-	-	-	-	-	-
	≤ 72 V	25 A	27 A	30 A	45 A	-	50 A	50 A	-	70 A	100 A	105 A	125 A	130 A
	110 V	10 A	15 A	20 A	45 A	-	50 A	50 A	-	70 A	100 A	105 A	125 A	130 A
	220 V	4 A	4 A	4 A	-	-	-	-	-	-	-	-	-	-
	≤ 72 V	25 A	27 A	30 A	45 A	-	50 A	50 A	-	70 A	100 A	105 A	125 A	130 A
	110 V	25 A	27 A	30 A	45 A	-	50 A	50 A	-	70 A	100 A	105 A	125 A	130 A
	220 V	9 A	12 A	16 A	20 A	-	25 A	25 A	-	70 A	100 A	105 A	125 A	130 A
	≤ 72 V	25 A	-	30 A	-	-	-	-	-	-	-	-	-	-
	110 V	25 A	-	30 A	-	-	-	-	-	-	-	-	-	-
	220 V	10 A	-	20 A	-	-	-	-	-	-	-	-	-	-
	440 V	4 A	-	4 A	-	-	-	-	-	-	-	-	-	-

For additional ratings ≥ 440 V, please consult us.



AF116 ... AF2050 contactors

DC circuit switching



Selection table

Contactor types	AF116	AF140	AF146	AF190	AF205	AF265	AF305	AF370	AF400	AF460	AF580	AF750	AF1250	AF1350	AF1650	AF2050
	3 or 4-pole			3-pole			3 or 4-pole			3-pole						

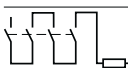

Utilization category DC-1, L/R ≤ 1 ms

	≤ 72 V	160	200	200	250	350	400	500	520	600 A	700 A	800 A	1050 A	1250 A	1350 A	1650 A	2050 A	
	90 V	160	200	200	250	350	400	500	520	-	-	-	-	-	-	-	-	
	100 V	-	-	-	250	350	400	500	520	-	-	-	-	-	-	-	-	-
	110 V	-	-	-	-	-	400	500	520	600 A	700 A	800 A	1050 A	1250 A	1350 A	1650 A	2050 A	
	≤ 72 V	160	200	200	250	350	400	500	520	600 A	700 A	800 A	1050 A	1250 A	1350 A	1650 A	2050 A	
	110 V	160	200	200	250	350	400	500	520	600 A	700 A	800 A	1050 A	1250 A	1350 A	1650 A	2050 A	
	175 V	160	200	200	250	350	400	500	520	600 A	700 A	800 A	1050 A	-	-	-	-	
	200 V	-	-	-	250	350	400	500	520	600 A	700 A	800 A	1050 A	-	-	-	-	
	220 V	-	-	-	-	-	400	500	520	600 A	700 A	800 A	1050 A	-	-	-	-	
	≤ 72 V	160	200	200	250	350	400	500	520	600 A	700 A	800 A	1050 A	1250 A	1350 A	1650 A	2050 A	
	110 V	160	200	200	250	350	400	500	520	600 A	700 A	800 A	1050 A	1250 A	1350 A	1650 A	2050 A	
	220 V	160	200	200	250	350	400	500	520	600 A	700 A	800 A	1050 A	1250 A	1350 A	1650 A	2050 A	
	260 V	160	200	200	250	350	400	500	520	600 A	700 A	800 A	1050 A	1250 A	1350 A	1650 A	2050 A	
	300 V	-	-	-	250	350	400	500	520	600 A	700 A	800 A	1050 A	1250 A	1350 A	1650 A	2050 A	
	340 V	-	-	-	-	-	400	500	520	600 A	700 A	800 A	1050 A	1250 A	1350 A	1650 A	2050 A	
	440 V	-	-	-	-	-	-	-	-	600 A	700 A	800 A	1050 A	1250 A	1350 A	1650 A	2050 A	
	600 V	-	-	-	-	-	-	-	-	600 A	700 A	800 A	1050 A	1250 A	1350 A	1650 A	2050 A	
	850 V	-	-	-	-	-	-	-	-	-	800 A	1050 A	1250 A	1350 A	1650 A	2050 A		
	< 350 V	200	200	-	250	350	400	500	520	-	-	-	-	-	-	-	-	
	400 V	-	-	-	250	350	400	500	520	-	-	-	-	-	-	-	-	
	440 V	-	-	-	-	-	400	500	520	-	-	-	-	-	-	-	-	

Utilization category DC-3, L/R ≤ 2 ms

	≤ 72 V	-	-	-	-	-	-	-	-	600 A	700 A	800 A	1050 A	-	-	-	-
	110 V	-	-	-	-	-	-	-	-	600 A	700 A	800 A	1050 A	-	-	-	-
	≤ 72 V	145 A	160 A	-	250 A	275 A	350 A	400 A	450 A	600 A	700 A	800 A	1050 A	-	-	-	-
	110 V	145 A	160 A	-	250 A	275 A	350 A	400 A	450 A	600 A	700 A	800 A	1050 A	-	-	-	-
	220 V	-	-	-	-	-	-	-	-	600 A	700 A	800 A	1050 A	-	-	-	-
	≤ 72 V	145 A	160 A	-	250 A	275 A	350 A	400 A	450 A	600 A	700 A	800 A	1050 A	-	-	-	-
	110 V	145 A	160 A	-	250 A	275 A	350 A	400 A	450 A	600 A	700 A	800 A	1050 A	-	-	-	-
	220 V	145 A	160 A	-	250 A	275 A	350 A	400 A	450 A	600 A	700 A	800 A	1050 A	-	-	-	-
	440 V	-	-	-	-	-	-	-	-	600 A	700 A	800 A	1050 A	-	-	-	-
	600 V	-	-	-	-	-	-	-	-	600 A	700 A	800 A	1050 A	-	-	-	-

Utilization category DC-5, L/R ≤ 7.5 ms

	≤ 72 V	-	-	-	-	-	-	-	-	600 A	700 A	800 A	1050 A	-	-	-	-
	110 V	-	-	-	-	-	-	-	-	600 A	700 A	800 A	1050 A	-	-	-	-
	≤ 72 V	145 A	160 A	-	250 A	275 A	350 A	400 A	450 A	600 A	700 A	800 A	1050 A	-	-	-	-
	110 V	145 A	160 A	-	250 A	275 A	350 A	400 A	450 A	600 A	700 A	800 A	1050 A	-	-	-	-
	220 V	-	-	-	-	-	-	-	-	600 A	700 A	800 A	1050 A	-	-	-	-
	≤ 72 V	145 A	160 A	-	250 A	275 A	350 A	400 A	450 A	600 A	700 A	800 A	1050 A	-	-	-	-
	110 V	145 A	160 A	-	250 A	275 A	350 A	400 A	450 A	600 A	700 A	800 A	1050 A	-	-	-	-
	220 V	145 A	160 A	-	250 A	275 A	350 A	400 A	450 A	600 A	700 A	800 A	1050 A	-	-	-	-
	440 V	-	-	-	-	-	-	-	-	600 A	700 A	800 A	1050 A	-	-	-	-
	600 V	-	-	-	-	-	-	-	-	600 A	700 A	800 A	1050 A	-	-	-	-

For additional ratings ≥ 440 V, please consult us.

EK110 ... EK1000 contactors

DC circuit switching

Selection table

Contactor types	EK110	EK150	EK175	EK210	EK370	EK550	EK1000
-----------------	-------	-------	-------	-------	-------	-------	--------

5 Utilization category DC-1, L/R ≤ 1 ms

	≤ 72 V	A	120	145	210	210	370	550	-
	110 V	A	120	145	210	210	370	550	-
	≤ 72 V	A	200	200	300	300	550	800	-
	110 V	A	200	200	300	300	550	800	-
	220 V	A	200	200	300	300	550	800	-
	≤ 72 V	A	200	200	300	300	550	800	-
	110 V	A	200	200	300	300	550	800	-
	220 V	A	200	200	300	300	550	800	-
	440 V	A	-	-	210	210	450	650	-
	600 V	A	-	-	-	-	450	650	-
	≤ 72 V	A	200	200	300	300	550	800	-
	110 V	A	200	200	300	300	550	800	-
	220 V	A	200	200	300	300	550	800	-
	440 V	A	200	200	260	260	450	650	-
	600 V	A	-	-	260	260	450	650	-

Utilization category DC-3, L/R ≤ 2 ms

	≤ 72 V	A	120	145	210	210	370	550	-
	110 V	A	135	135	210	210	450	650	-
	≤ 72 V	A	135	135	210	210	450	650	-
	110 V	A	135	135	210	210	450	650	-
	220 V	A	135	135	210	210	450	650	-
	≤ 72 V	A	135	135	210	210	450	650	-
	110 V	A	135	135	210	210	450	650	-
	220 V	A	135	135	210	210	450	650	-
	440 V	A	-	-	210	210	450	650	-
	600 V	A	-	-	-	-	450	650	-
	≤ 72 V	A	135	135	210	210	450	650	-
	110 V	A	135	135	210	210	450	650	-
	220 V	A	135	135	210	210	450	650	-
	440 V	A	135	135	210	210	450	650	-
	600 V	A	-	-	170	210	450	650	-

Utilization category DC-5, L/R ≤ 7.5 ms

	≤ 72 V	A	135	145	210	210	450	650	-
	110 V	A	135	135	210	210	450	650	-
	220 V	A	135	135	210	210	450	650	-
	≤ 72 V	A	135	145	210	210	450	650	-
	110 V	A	135	135	210	210	450	650	-
	220 V	A	135	135	210	210	450	650	-
	440 V	A	-	-	210	210	450	650	-
	600 V	A	-	-	-	-	450	650	-
	≤ 72 V	A	135	145	210	210	450	650	-
	110 V	A	135	135	210	210	450	650	-
	220 V	A	135	135	210	210	450	650	-
	440 V	A	135	135	210	210	450	650	-
	600 V	A	-	-	170	210	450	650	-

Notes

A series of horizontal dotted lines for taking notes, spanning the width of the page.

GA75 1-pole contactors

100 A DC-1

AC operated



GA75-10-11

1SBC101423S0201

Description

GA75 contactors are designed for controlling shunt or series motors and resistive or slightly inductive loads up to 1000 V DC.

These contactors are of the block type design with 3 main poles connected in series.

- main poles arc chutes fitted with permanent magnets specially designed for DC breaking. The connection polarities must be respected.
- control circuit: AC operated
- add-on auxiliary contact blocks for side mounting and a wide range of accessories.

Ordering details

IEC Rated operational current $\theta \leq 55^\circ\text{C}$ 440 V DC-1 A	UL / CSA General use rating 440 V DC A	Rated control circuit voltage Uc (1)		Auxiliary contacts fitted		Type	Order code	Weight Pkg (1 pce) kg
		V 50 Hz	V 60 Hz					
100	100	24	24	0	0	GA75-10-00	1SBL411025R8100	1.220
				1	1	GA75-10-11	1SBL411025R8111	1.260
		48	48	0	0	GA75-10-00	1SBL411025R8300	1.220
				1	1	GA75-10-11	1SBL411025R8311	1.260
		110	110...120	0	0	GA75-10-00	1SBL411025R8400	1.220
				1	1	GA75-10-11	1SBL411025R8411	1.260
		220...230	230...240	0	0	GA75-10-00	1SBL411025R8000	1.220
				1	1	GA75-10-11	1SBL411025R8011	1.260
		230...240	240...260	0	0	GA75-10-00	1SBL411025R8800	1.220
				1	1	GA75-10-11	1SBL411025R8811	1.260
		380...400	400...415	0	0	GA75-10-00	1SBL411025R8500	1.220
				1	1	GA75-10-11	1SBL411025R8511	1.260
		400...415	415...440	0	0	GA75-10-00	1SBL411025R8600	1.220
				1	1	GA75-10-11	1SBL411025R8611	1.260

(1) Other control voltages see voltage codes table.

Main dimensions mm, inches

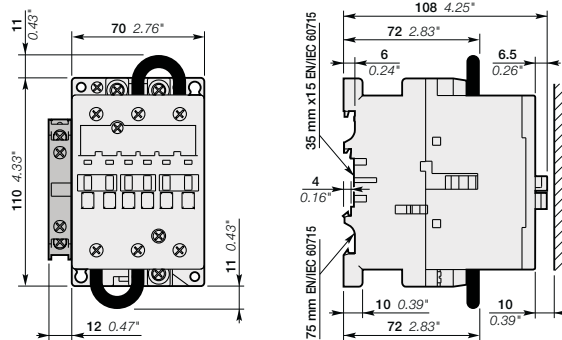

GA75-10-11

1SBC101423S0201

GAE75 1-pole contactors

100 A DC-1

DC operated



GAE75-10-11

Description

GAE75 contactors are designed for controlling shunt or series motors and resistive or slightly inductive loads up to 1000 V DC.

These contactors are of the block type design with 3 main poles connected in series.

- main poles arc chutes fitted with permanent magnets specially designed for DC breaking. The connection polarities must be respected.
- control circuit: DC operated with double winding coil (and factory mounted lagging contact for "holding" winding insertion)
- add-on auxiliary contact blocks for side mounting and a wide range of accessories

Ordering details

IEC Rated operational current $\theta \leq 55^\circ\text{C}$ 440 V DC-1 A	UL/CSA General use rating 440 V DC A	Rated control circuit voltage Uc (1) V DC	Auxiliary contacts fitted I L Y Y	Type	Order code	Weight Pkg (1 pce) kg
100	100	12	0 0	GAE75-10-00	1SBL419025R8000	1.260
			1 1	GAE75-10-11	1SBL419025R8011	1.300
		24	0 0	GAE75-10-00	1SBL419025R8100	1.260
			1 1	GAE75-10-11	1SBL419025R8111	1.300
		48	0 0	GAE75-10-00	1SBL419025R8300	1.260
			1 1	GAE75-10-11	1SBL419025R8311	1.300
		60	0 0	GAE75-10-00	1SBL419025R8400	1.260
			1 1	GAE75-10-11	1SBL419025R8411	1.300
		110	0 0	GAE75-10-00	1SBL419025R8600	1.260
			1 1	GAE75-10-11	1SBL419025R8611	1.300
		125	0 0	GAE75-10-00	1SBL419025R8700	1.260
			1 1	GAE75-10-11	1SBL419025R8711	1.300
		220	0 0	GAE75-10-00	1SBL419025R8800	1.260
			1 1	GAE75-10-11	1SBL419025R8811	1.300
		240	0 0	GAE75-10-00	1SBL419025R8900	1.260
			1 1	GAE75-10-11	1SBL419025R8911	1.300

(1) Other control voltages see voltage codes table.

Main dimensions mm, inches

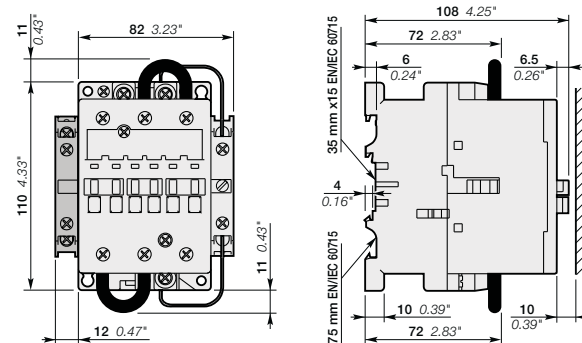

GAE75-10-11

GAF185 ... GAF300 3-pole contactors

250 to 400 A DC-1

AC / DC operated with 1 N.O. + 1 N.C. auxiliary contact



GAF185-10-11

1SFC101038R0001



GAF300-10-11

1SFC101038R0001

Description

GAF185 ... GAF300 contactors are designed for controlling resistive or slightly inductive loads up to 1000 V DC. These contactors are of the block type design with 3 main poles for connection in series by the user according to conductor cross-sectional area or by using LP connection bars to be ordered separately.

- main poles arc chutes fitted with permanent magnets specially designed for DC breaking. The connection polarities must be respected.
- control circuit: AC or DC operated with electronic coil interface accepting a wide control voltage range (e.g. 100...250 V AC and DC), only 3 coils to cover control voltages between 48...250 V 50/60 Hz and 20...250 V DC
 - can manage large control voltage variations
 - reduced panel energy consumption
 - very distinct closing and opening
 - can withstand short voltage dips and voltage sags (SEMI F47 conditions of use on request).
- built-in surge suppression
- add-on auxiliary contact blocks for side mounting and a wide range of accessories.

Ordering details

IEC Rated operational current $\theta \leq 55^\circ\text{C}$ 1000 V DC-1	UL / CSA General use rating $\theta \leq 40^\circ\text{C}$ 1000 V DC	Rated control circuit voltage Uc		Auxiliary contacts fitted	Type	Order code	Weight Pkg (1 pce) kg
		V 50/60 Hz	V DC				
250	250	-	20...60	1 1	GAF185-10-11 (1)	1SFL497025R7211	3.600
		48...130	48...130	1 1	GAF185-10-11	1SFL497025R6911	3.600
		100...250	100...250	1 1	GAF185-10-11	1SFL497025R7011	3.600
400	400	-	20...60	1 1	GAF300-10-11 (1)	1SFL557025R7211	6.200
		48...130	48...130	1 1	GAF300-10-11	1SFL557025R6911	6.200
		100...250	100...250	1 1	GAF300-10-11	1SFL557025R7011	6.200

(1) The connection polarities indicated close to the coil terminals must be respected: A1 for the positive pole and A2 for the negative pole.

Main dimensions mm, inches

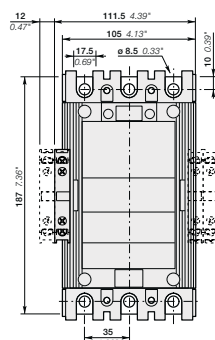

GAF185

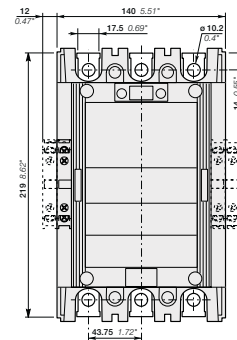

GAF300

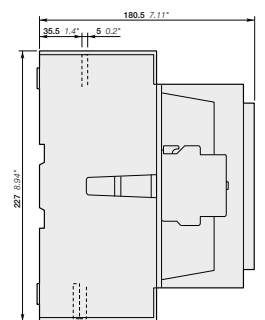

1SFC101023C0201 - Rev. A

GAF460 ... GAF750 3-pole contactors

600 to 875 A DC-1

AC / DC operated with 1 N.O. + 1 N.C. auxiliary contact



GAF460-10-11

1SFC101102F0001



GAF750-10-11

1SFC101102F0001

Description

GAF460 ... GAF750 contactors are designed for controlling resistive or slightly inductive loads up to 1000 V DC. These contactors are of the block type design with 3 main poles for connection in series by the user according to conductor cross-sectional area or by using LP connection bars to be ordered separately.

- main poles arc chutes fitted with permanent magnets specially designed for DC breaking. The connection polarities must be respected.
- control circuit: AC or DC operated with electronic coil interface accepting a wide control voltage range (e.g. 100...250 V AC and DC), only 4 coils to cover control voltages between 48...500 V 50/60 Hz and 24...500 V DC
- can manage large control voltage variations
- reduced panel energy consumption
- very distinct closing and opening
- can withstand short voltage dips and voltage sags (SEMI F47 conditions of use on request).
- built-in surge suppression
- add-on auxiliary contact blocks for side mounting and a wide range of accessories.

Ordering details

IEC Rated operational current $\theta \leq 55^\circ\text{C}$ 1000 V DC-1	UL / CSA General use rating $\theta \leq 40^\circ\text{C}$ 1000 V DC	Rated control circuit voltage U_c		Auxiliary contacts fitted Y L	Type	Order code	Weight Pkg (1 pce) kg
		V 50/60 Hz	V DC				
A 600	A 650	-	24...60	1 1	GAF460-10-11 (1)	1SFL597025R6811	12.000
		48...130	48...130	1 1	GAF460-10-11	1SFL597025R6911	12.000
		100...250	100...250	1 1	GAF460-10-11	1SFL597025R7011	12.000
		250...500	250...500	1 1	GAF460-10-11	1SFL597025R7111	12.000
A 875	A 900	-	24...60	1 1	GAF750-10-11 (1)	1SFL637025R6811	15.000
		48...130	48...130	1 1	GAF750-10-11	1SFL637025R6911	15.000
		100...250	100...250	1 1	GAF750-10-11	1SFL637025R7011	15.000
		250...500	250...500	1 1	GAF750-10-11	1SFL637025R7111	15.000

(1) The connection polarities indicated close to the coil terminals must be respected: A1 for the positive pole and A2 for the negative pole.

GAF460 ... GAF750 are equipped with low voltage inputs for control, for example by a PLC.

Control inputs

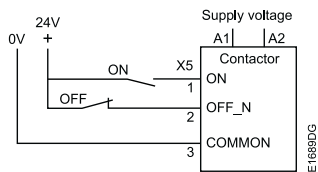

Main dimensions mm, inches

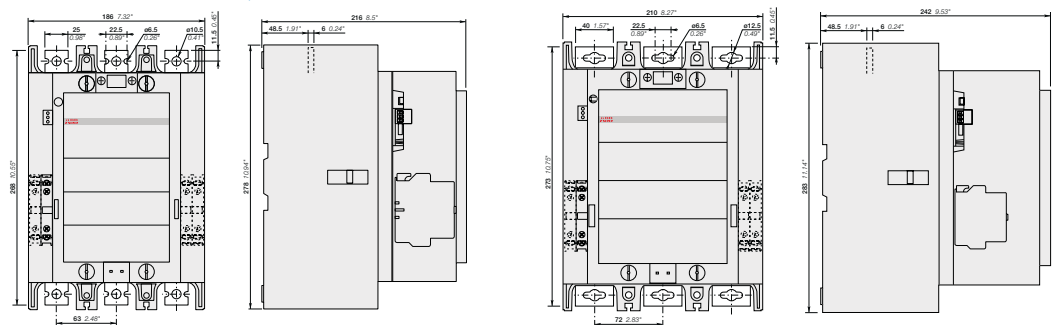

GAF460

GAF750

GAF1250 ... GAF2050 3-pole contactors

1040 to 1750 A DC-1

AC / DC operated with 1 N.O. + 1 N.C. auxiliary contact



GAF1250-10-11

Description

- GAF1250 ... GAF2050 contactors are designed for controlling resistive or slightly inductive loads up to 1000 V DC. These contactors are of the block type design with 3 main poles for connection in series by the user according to conductor cross-sectional area or by using LP connection bars to be ordered separately.
- main poles arc chutes fitted with permanent magnets specially designed for DC breaking. The connection polarities must be respected.
 - control circuit: AC or DC operated with electronic coil interface accepting a wide control voltage range (e.g. 100...250 V AC and DC), only 4 coils to cover control voltages between 48...500 V 50/60 Hz and 24...500 V DC
 - can manage large control voltage variations
 - reduced panel energy consumption
 - very distinct closing and opening
 - can withstand short voltage dips and voltage sags (SEMI F47 conditions of use on request).
 - built-in surge suppression
 - add-on auxiliary contact blocks for side mounting and a wide range of accessories.



GAF1650-10-11

Ordering details

IEC Rated operational current $\theta \leq 55^\circ\text{C}$ 1000 V DC-1	UL / CSA General use rating $\theta \leq 40^\circ\text{C}$ 1000 V	Rated control circuit voltage Uc		Auxiliary contacts fitted	Type	Order code	Weight Pkg (1 pce) kg
		V 50/60 Hz	V DC				
A 1040	A 1210	-	24...60	1 1	GAF1250-10-11	1SFL647025R6811	16.000
		48...130	48...130	1 1	GAF1250-10-11	1SFL647025R6911	16.000
		100...250	100...250	1 1	GAF1250-10-11	1SFL647025R7011	16.000
		250...500	250...500	1 1	GAF1250-10-11	1SFL647025R7111	16.000
1450	1650	100...250	100...250	1 1	GAF1650-10-11	1SFL677025R7011	35.000
1750	2050	100...250	100...250	1 1	GAF2050-10-11	1SFL707025R7011	35.000

GAF1250 ... AF2050 are equipped with low voltage inputs for control, for example by a PLC

Control inputs

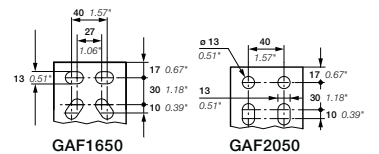
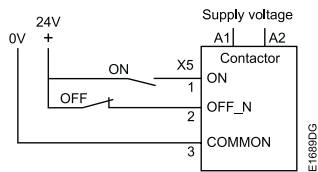

Main dimensions mm, inches

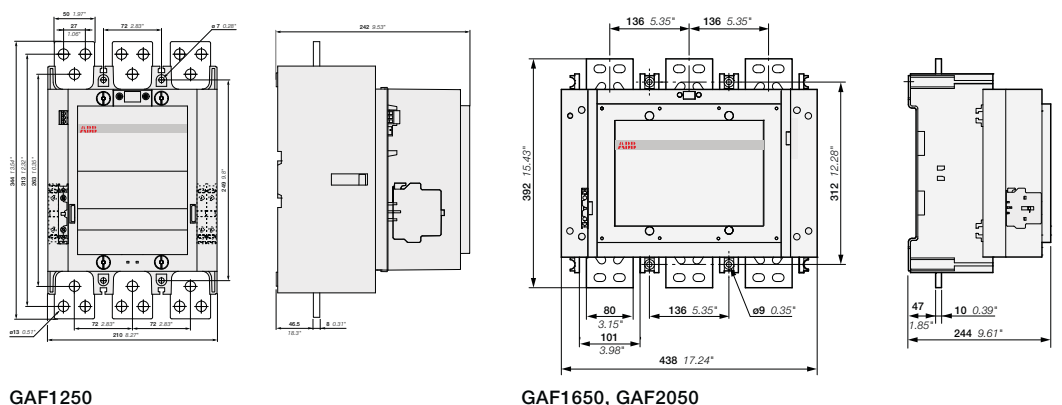

GAF185 ... GAF2050 3-pole contactors

Main accessories

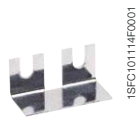

LP185

1SFC10114F0001



LP2050

1SFC10117F0001

Ordering details

For contactors	Auxiliary contacts	Type	Order code	Pkg qty	Weight (1 pce)
	 				kg

Auxiliary contact blocks, low energy microswitch 0.1 A, N.O. or N.C.

GAF185 ... GAF2050	0 1	CEL18-01	1SFN010716R1001		0.050
	1 0	CEL18-10	1SFN010716R1010		0.050

Connection bar for contactor

GAF185	LP185	1SFN074712R1000	2	0.300
GAF300	LP300	1SFN075112R1000	2	0.400
GAF460	LP460	1SFN075712R1000	4	0.550
GAF750	LP750	1SFN076112R1000	4	0.950
GAF1250	LP1250	1SFN076412R1000	2	1.900
GAF1650, GAF2050	LP2050	1SFN076512R1000	4	2.900

GA75 ... GAF2050 contactors

Technical data

Main pole - Utilization characteristics according to IEC

Contactor types	AC operated	GA75								
	DC operated	GAE75								
	AC / DC operated	GAF185	GAF300	GAF460	GAF750	GAF1250	GAF1650	GAF2050		
Standards		IEC 60947-1 / 60947-4-1 and EN 60947-1 / 60947-4-1								
Rated operational voltage U_e max.		1000 V DC								
DC-1 Utilization category, $L/R \leq 1$ ms										
For air temperature close to contactor										
le / Rated operational current DC-1 $\theta \leq 40$ °C	220 V	120 A	-	-	-	-	-	-	-	
	440 V	100 A	-	-	-	-	-	-	-	
	600 V	75 A	-	-	-	-	-	-	-	
	1000 V	35 A	275 A	500 A	700 A	1050 A	1250 A	1650 A	2050 A	
	$\theta \leq 55$ °C	220 V	100 A	-	-	-	-	-	-	-
		440 V	100 A	-	-	-	-	-	-	-
		600 V	75 A	-	-	-	-	-	-	-
	$\theta \leq 70$ °C	1000 V	35 A	250 A	400 A	600 A	875 A	1040 A	1450 A	1750 A
		220 V	85 A	-	-	-	-	-	-	-
		440 V	85 A	-	-	-	-	-	-	-
		600 V	75 A	-	-	-	-	-	-	-
	With conductor cross-sectional area	1000 V	35 A	180 A	325 A	480 A	720 A	875 A	1270 A	1500 A
		(1)	150 mm ²	300 mm ²	2x 240 mm ²	2x 50x8 mm ²	2x 100x5 mm ²	3x 100x5 mm ²	4x 100x5 mm ²	
DC-3 Utilization category, $L/R \leq 2$ ms										
le / Rated operational current DC-3 $\theta \leq 55$ °C	220 V	100 A	-	-	-	-	-	-	-	
	440 V	85 A	-	-	-	-	-	-	-	
DC-5 Utilization category, $L/R \leq 7.5$ ms										
le / Rated operational current DC-5 $\theta \leq 55$ °C	220 V	85 A	-	-	-	-	-	-	-	
	440 V	35 A	-	-	-	-	-	-	-	
Maximum electrical switching frequency		300 cycles/h								

(1) Refer to IEC 60947-1, table 9.

(2) For currents above 450 A, use 300 mm² and terminal extension/enlargement pieces (LX300/LW300).

Main pole - Utilization characteristics according to UL / CSA

Contactor types	AC operated	GA75							
	DC operated	GAE75							
	AC / DC operated	GAF185	GAF300	GAF460	GAF750	GAF1250	GAF1650	GAF2050	
Standards		UL 508, CSA C22.2 N°14		UL 60947-4-1, CSA C22.2 N°60947.4-1					
Maximum operational voltage		1000 V DC							
UL / CSA DC general use rating									
$\theta \leq 40$ °C	440 V	100 A	-	-	-	-	-	-	-
	600 V	75 A	250 A	400 A	-	-	-	-	-
	1000 V	35 A	250 A	400 A	650 A	900 A	1210 A	1650 A	2050 A
Maximum electrical switching frequency		300 cycles/h							

GA75 and GAE75 contactors

Technical data

General technical data

Contactor types	AC operated	GA75
	DC operated	GAE75
Rated insulation voltage U_i acc. to IEC 60947-4-1		1000 V
acc. to UL		600 V
Rated impulse withstand voltage U_{imp}		8 kV
Ambient air temperature close to contactor		
Operation		-40...+70 °C
Storage		-60...+80 °C
Climatic withstand		acc. to IEC 60068-2-30 and 60068-2-11 - UTE C 63-100 specification II
Maximum operating altitude (without derating)		3000 m
Mechanical durability		
Number of operating cycles		10 millions operating cycles (5 millions for GAE75)
Max. switching frequency		3600 cycles/h
Shock withstand acc. to IEC 60068-2-27 and EN 60068-2-27 Mounting position 1		
	Shock direction	1/2 sinusoidal shock for 11 ms: no change in contact position, closed or open position
	A	20 g
	B1	10 g closed position / 5 g open position
	B2	15 g
	C1	20 g
	C2	20 g

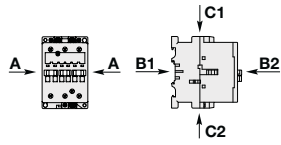

GAF185 ... GAF2050 contactors

Technical data

General technical data

Contactor types	AC / DC operated	GAF185	GAF300	GAF460	GAF750	GAF1250	GAF1650	GAF2050
Rated insulation voltage Ui								
acc. to IEC 60947-4-1		1000 V						
acc. to UL		600 V						
Rated impulse withstand voltage Uimp.		8 kV						
Ambient air temperature close to contactor								
Operation		-40 to +70 °C						
Storage		-40 to +70 °C						
Climatic withstand		acc. to IEC 60068-2-30						
Maximum operating altitude (without derating)		3000 m						
Mechanical durability								
Number of operating cycles		5 millions operating cycles					0.5 millions operating cycles	
Max. switching frequency		300 cycles/h					60 cycles/h	
Shock withstand								
acc. to IEC 60068-2-27 and EN 60068-2-27								
Mounting position 1								
	Shock direction	1/2 sinusoidal shock for 30 ms: no change in contact position, closed or open position						
	A	5 g						-
	B1	5 g						-
	B2	5 g						-
	C1	5 g						-
	C2	5 g						-

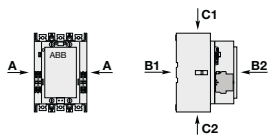

GA75 and GAE75 contactors

Technical data

Magnet system characteristics

Contactor types	AC operated	GA75	
Coil operating limits acc. to IEC 60947-4-1	AC supply	At $\theta \leq 55^\circ\text{C}$ 0.85...1.1 x U_c Please also refer to "Mounting characteristics and conditions for use"	
AC control voltage			
Rated control circuit voltage U_c	at 50 Hz	24...690 V	
	at 60 Hz	24...690 V	
Coil consumption	Average pull-in value	50 Hz	180 VA
		60 Hz	210 VA
	Average holding value	50/60 Hz (1)	190 VA / 180 VA
		50 Hz	18 VA / 5.5 W
		60 Hz	18 VA / 5.5 W
		50/60 Hz (1)	18 VA / 5.5 W
Drop-out voltage		Approx. 40...65 % of U_c	
Operating time			
Between coil energization and:	N.O. contact closing	8...27 ms	
	N.C. contact opening	7...22 ms	
Between coil de-energization and:	N.O. contact opening	4...11 ms	
	N.C. contact closing	7...14 ms	

(1) 50/60 Hz coils: see "Voltage code table".

Magnet system characteristics

Contactor types	DC operated	GAE75
Coil operating limits acc. to IEC 60947-4-1	AC supply	At $\theta \leq 55^\circ\text{C}$ 0.85...1.1 x U_c Please also refer to "Mounting characteristics and conditions for use"
DC control voltage		
Rated control circuit voltage U_c		12...250 V DC
Coil consumption	Average pull-in value	200 W
	Average holding value	4 W
Drop-out voltage		Approx. 15...40 % of U_c
Coil time constant		
Open	L/R	3 ms
Closed	L/R	15 ms
Operating time		
Between coil energization and:	N.O. contact closing	13...30 ms
	N.C. contact opening	10...27 ms
Between coil de-energization and:	N.O. contact opening (1)	5...15 ms
	N.C. contact closing (1)	8...18 ms

(1) The use of surge suppressors increases the opening time with a factor of 1.1 to 1.5 for a RV5 surge suppressor and a factor of 1.5 to 3 for RT5 surge suppressor.

Mounting characteristics and conditions for use

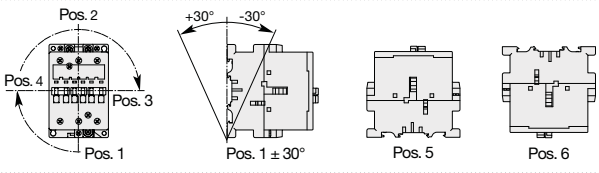
Contactor types	AC operated	GA75
	DC operated	GAE75
Mounting positions		
Control voltage / Ambient temperature		
Mounting positions	1, 1±30°, 2, 3, 4, 5	at $\theta \leq 55^\circ\text{C}$ 0.85...1.1 x U_c
		at $\theta \leq 70^\circ\text{C}$ U_c
	6	at $\theta \leq 55^\circ\text{C}$ 0.95...1.1 x U_c
		at $\theta \leq 70^\circ\text{C}$ Unauthorized
Mounting distances	The contactors can be assembled side by side	
Fixing		
On rail according to IEC 60715, EN 60715	35 x 15 mm or 75 x 25 mm	
By screws (not supplied)	2 x M6 screws placed diagonally	

GAF185 ... GAF2050 contactors

Technical data

Magnet system characteristics

Contactor types	AC / DC operated	GAF185	GAF300	GAF460	GAF750	GAF1250	GAF1650	GAF2050
Coil operating limits	AC or DC supply	At $\theta \leq 70^\circ\text{C}$ $0.85 \times U_c \text{ min...} 1.1 \times U_c \text{ max.}$ Please also refer to "Mounting characteristics and conditions for use"						
acc. to IEC 60947-4-1								
AC control voltage 50/60 Hz								
Rated control circuit voltage U_c		48...250 V AC			48...500 V AC		100...250 V AC	
Coil consumption	Average pull-in value	430 VA	470 VA	890 VA	850 VA	1900 VA		
	Average holding value	12 VA / 3.5 W	10 VA / 2.5 W	12 VA / 4 W	12 VA / 4.5 W	48 VA / 17 W		
DC control voltage								
Rated control circuit voltage U_c		20...250 V DC			24...500 V DC		100...250 V DC	
Coil consumption	Average pull-in value	500 W	520 W	990 W	950 W	1700 W		
	Average holding value	2 W		4 W	4.5 W	16 W		
Drop-out voltage		55 % of U_c min.						
Dips withstand		$-20^\circ\text{C} \leq \theta \leq +60^\circ\text{C}$						
Operating time		$\geq 20 \text{ ms}$						
Coil supply between A1 - A2								
Between coil energization and:	N.O. contact closing	30...115 ms			50...120 ms		50...80 ms	
	N.C. contact opening	30...115 ms			50...120 ms		50...80 ms	
Between coil de-energization and:	N.O. contact opening	25...80 ms			33...70 ms		35...55 ms	
	N.C. contact closing	25...80 ms			33...70 ms		35...55 ms	
Control input for PLC's								
Between coil energization and:	N.O. contact closing	-			40...60 ms	40...90 ms	40...65 ms	
	N.C. contact opening	-			40...60 ms	40...90 ms	40...65 ms	
Between coil de-energization and:	N.O. contact opening	-			10...30 ms		10...30 ms	
	N.C. contact closing	-			10...30 ms		10...30 ms	





Mounting characteristics and conditions for use

Contactor types	AC / DC operated	GAF185	GAF300	GAF460	GAF750	GAF1250	GAF1650	GAF2050
Mounting positions								
Control voltage / Ambient temperature								
Mounting positions	1, 1±30°, 2, 3, 4, 5	at $\theta \leq 70^\circ\text{C}$						
	6	Unauthorized						
Mounting distances		The contactors can be assembled side by side						
Fixing								
On rail according to IEC 60715, EN 60715		-						
By screws (not supplied)		4 x M5			4 x M6		4 x M8	

GA75 and GAE75 contactors

Technical data









Connecting characteristics

Contactor types	AC operated	GA75
	DC operated	GAE75
Main terminals		 Screw terminals with single connector (13 x 10 mm)
Connection capacity (min. ... max.)		
Main conductors (poles)		
 Rigid	Solid ($\leq 4 \text{ mm}^2$)	} 1 x 6...50 mm ² 2 x 6...25 mm ²
	Stranded ($\geq 6 \text{ mm}^2$)	
 Flexible with ferrule		1 x 6...35 mm ² 2 x 6...16 mm ²
 Bars or lugs		L \leq - L $>$ -
Connection capacity acc. to UL/CSA	1 or 2 x	AWG 8...1
Tightening torque	Recommended	4.00 Nm / 35 lb.in
	Max.	4.50 Nm
Auxiliary conductors (coil terminals)		
 Rigid solid		1 x 1...4 mm ² 2 x 1...4 mm ²
 Flexible with ferrule		1 x 1...2.5 mm ² 2 x 0.75...2.5 mm ²
 Lugs		L \leq 8 mm L $>$ 3.7 mm
Connection capacity acc. to UL / CSA	1 or 2 x	AWG 18...14
Tightening torque		
Coil terminals	Recommended	1.00 Nm / 9 lb.in
	Max.	1.20 Nm
Degree of protection		
acc. to IEC 60947-1 / EN 60947-1 and IEC 60529 / EN 60529		
Main terminals		IP10
Coil terminals		IP20
Screw terminals		
Delivered in open position, screws of unused terminals must be tightened		
Main terminals		M6
	Screwdriver type	Flat \varnothing 6.5 / Pozidriv 2
Coil terminals		M3.5
	Screwdriver type	Flat \varnothing 5.5 / Pozidriv 2

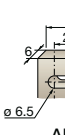
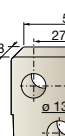
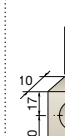
GAF185 ... GAF2050 contactors

Technical data

Connecting characteristics

Contactor types	AC / DC operated	GAF185	GAF300	GAF460	GAF750	GAF1250	GAF1650	GAF2050
Main terminals Flat type								
Connection capacity (min. ... max.)								
Main conductors (poles)								
 Rigid with connector	Single for Cu cable	6...185 mm ²	16...240 mm ²	240 mm ²	300 mm ²	300 mm ²	—	—
	Single for Al/Cu cable	25...150 mm ²	120...240 mm ²	240 mm ²	300 mm ²	300 mm ²	—	—
	Double for Al/Cu cable	—	2 x 95...120 mm ²	2 x 240 mm ²	3 x 185 mm ²	3 x 185 mm ²	—	—
 Bars or lugs	L ≤	24 mm	32 mm	47 mm	52 mm	52 mm	100 mm	100 mm
	Ø >	8 mm	10 mm	10 mm	12 mm	12 mm	12 mm	12 mm
Connection capacity acc. to UL/CSA	1 or 2 x	6 - 250 MCM	4 - 500 MCM (1)	2//250 - 500 MCM	3// 2/0 - 500 MCM	3// 2/0 - 500 MCM	1/0 - 750 MCM	1/0 - 750 MCM
Tightening torque	Recommended	18 Nm / 160 lb.in	28 Nm / 247 lb.in	35 Nm / 310 lb.in	45 Nm / 398 lb.in	45 Nm / 398 lb.in	45 Nm / 398 lb.in	45 Nm / 398 lb.in
	Max.	20 Nm	30 Nm	40 Nm	49 Nm	49 Nm	49 Nm	49 Nm
Auxiliary conductors (coil terminals)								
 Rigid solid	1 x	1...4 mm ²	1...4 mm ²	1...4 mm ²	1...4 mm ²	1...4 mm ²	1...4 mm ²	1...4 mm ²
	2 x	1...4 mm ²	1...4 mm ²	1...4 mm ²	1...4 mm ²	1...4 mm ²	1...4 mm ²	1...4 mm ²
 Flexible with ferrule	1 x	0.75...2.5 mm ²	0.75...2.5 mm ²	0.75...2.5 mm ²	0.75...2.5 mm ²	0.75...2.5 mm ²	0.75...2.5 mm ²	0.75...2.5 mm ²
	2 x	0.75...2.5 mm ²	0.75...2.5 mm ²	0.75...2.5 mm ²	0.75...2.5 mm ²	0.75...2.5 mm ²	0.75...2.5 mm ²	0.75...2.5 mm ²
 Lugs	L ≤	8 mm	8 mm	8 mm	8 mm	8 mm	8 mm	8 mm
	l >	3.7 mm	3.7 mm	3.7 mm	3.7 mm	3.7 mm	3.7 mm	3.7 mm
Connection capacity acc. to UL/CSA	1 or 2 x	AWG 18...14	AWG 18...14	AWG 18...14	AWG 18...14	AWG 18...14	AWG 18...14	AWG 18...14
Tightening torque	Recommended	1.00 Nm / 9 lb.in	1.00 Nm / 9 lb.in	1.00 Nm / 9 lb.in	1.00 Nm / 9 lb.in	1.00 Nm / 9 lb.in	1.00 Nm / 9 lb.in	1.00 Nm / 9 lb.in
	Max.	1.20 Nm	1.20 Nm	1.20 Nm	1.20 Nm	1.20 Nm	1.20 Nm	1.20 Nm
Degree of protection acc. to IEC 60947-1 / EN 60947-1 and IEC 60529 / EN 60529								
Main terminals		IP00	IP00	IP00	IP00	IP00	IP00	IP00
Coil terminals		IP20	IP20	IP20	IP20	IP20	IP20	IP20
Screw terminals								
Main terminals		M8	M10	M10	M10	M12	M12	M12
Coil terminals (delivered in open position)		M3.5	M3.5	M3.5	M3.5	M3.5	M3.5	M3.5
	Screwdriver type	Flat Ø 5.5 mm / Pozidriv 2						

(1) With LW110 enlargement piece: see "Accessories".

GA75 ... GAF2050 contactors

Terminal marking and positioning

GA75 contactors - AC operated

Standard devices without addition of auxiliary contacts

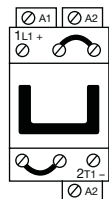

GA75-10-00

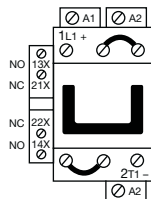

GA75-10-11

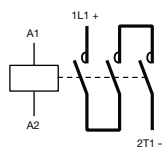

GA75-10-00

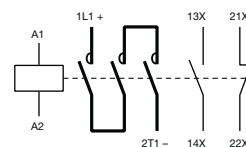

GA75-10-11

GAE75 contactors - DC operated

Standard devices without addition of auxiliary contacts

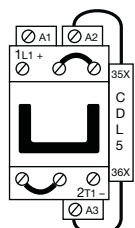

GAE75-10-00

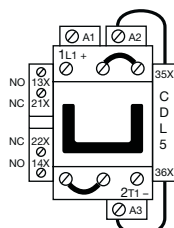

GAE75-10-11

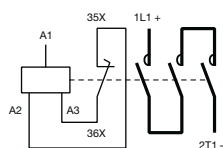

GAE75-10-00

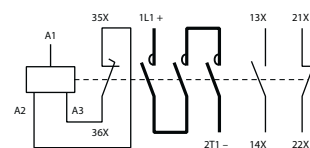

GAE75-10-11

GAF185 ... GAF2050 contactors - AC / DC operated

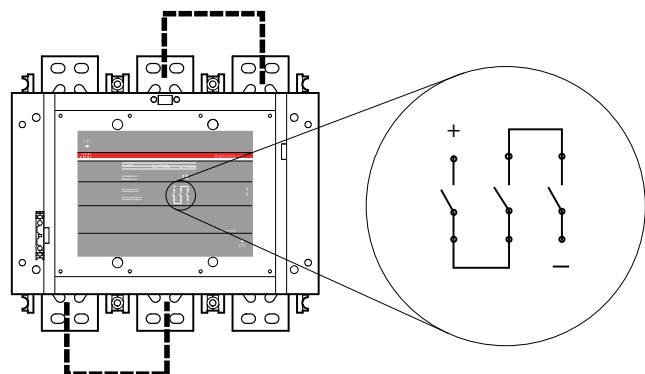

GAF185 ... GAF2050-10-11

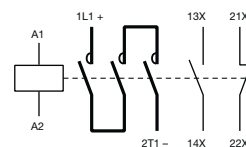

GAF185 ... GAF2050-10-11

GA75 1-pole contactor GAE75 1-pole contactor

Main dimensions mm, inches

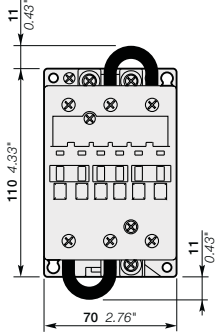

GA75-10-00

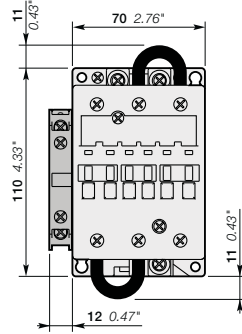

GA75-10-11

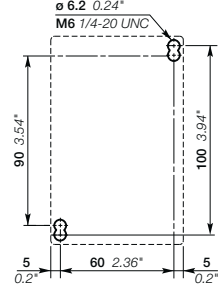
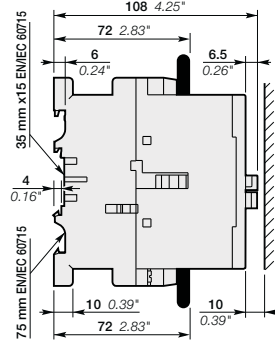

GA75

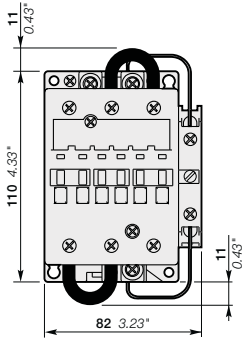

GAE75-10-00

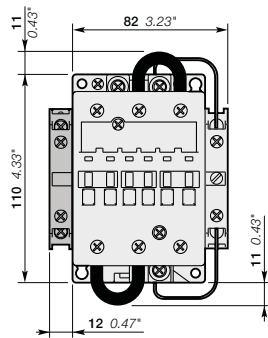

GAE75-10-11

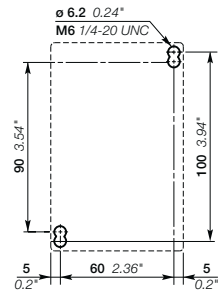
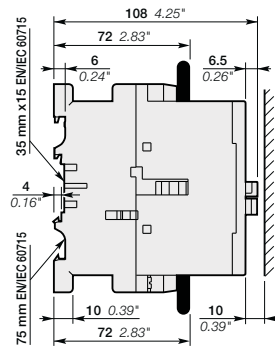

GAE75

GAF185, GAF300 3-pole contactor

Main dimensions mm, inches

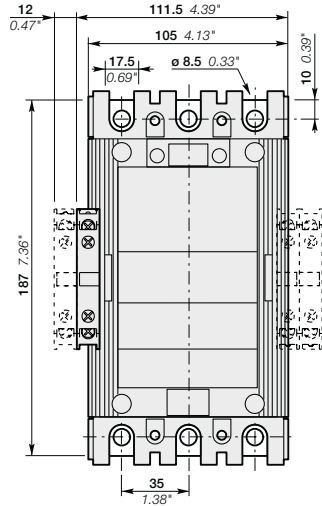

GAF185-30-11

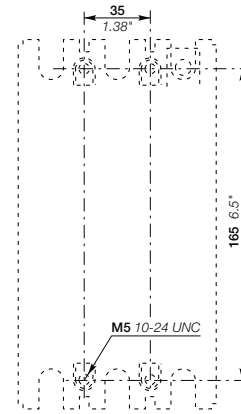
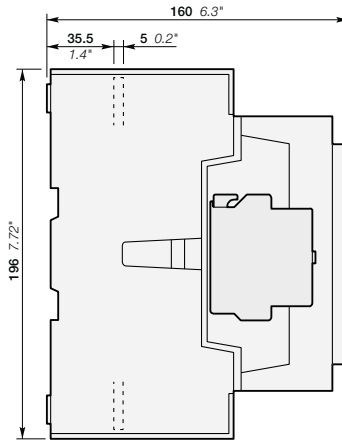

GAF185-30-11

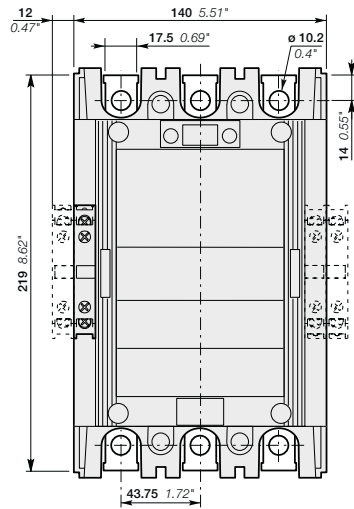

GAF300-30-11

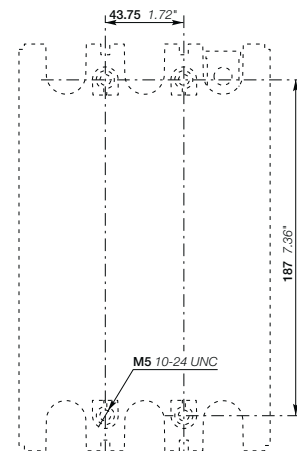
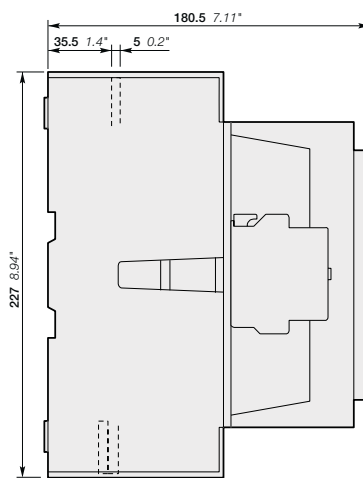

GAF300-30-11

GAF460 3-pole contactor

Main dimensions mm, inches

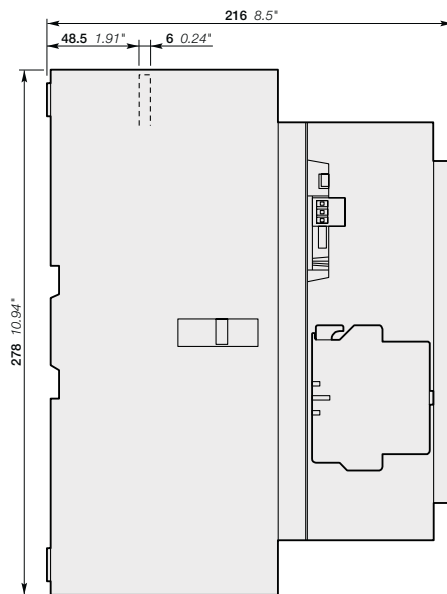
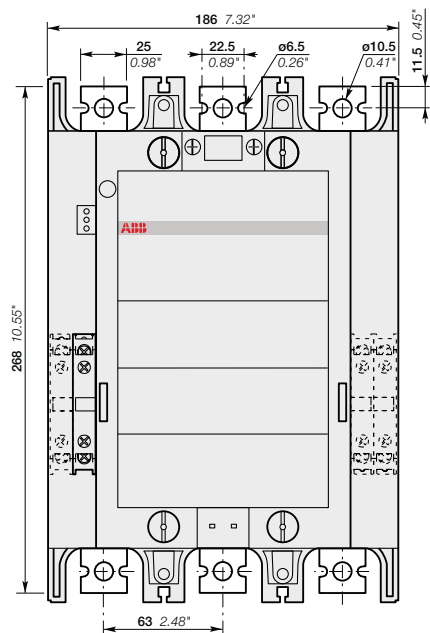

GAF460-30-11

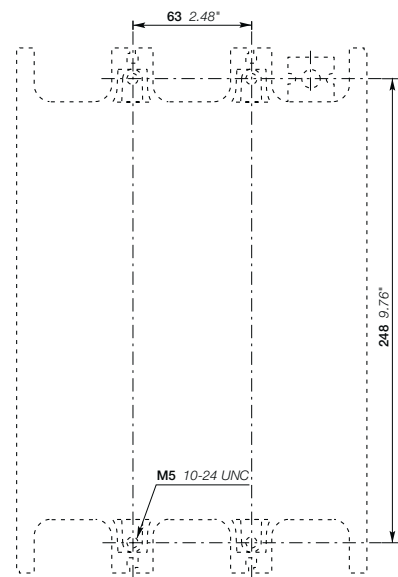

GAF750 3-pole contactor

Main dimensions mm, inches

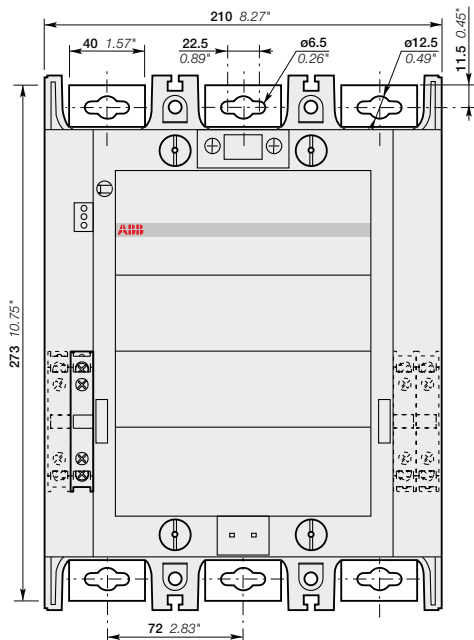

GAF750-30-11

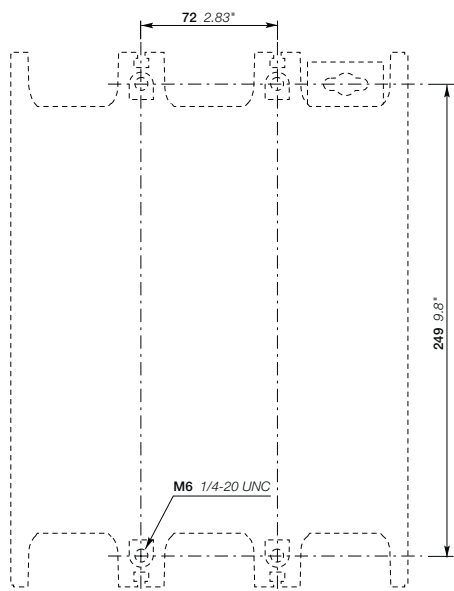
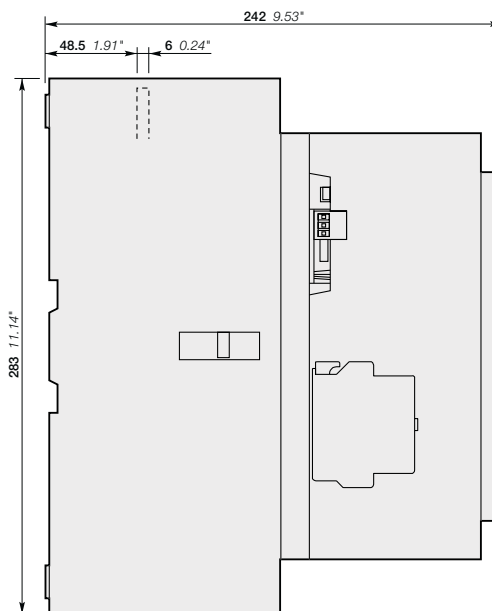

GAF1250 3-pole contactor

Main dimensions mm, inches

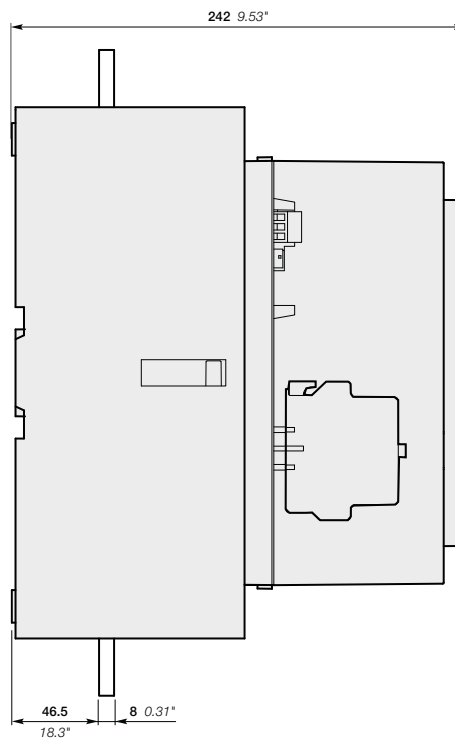
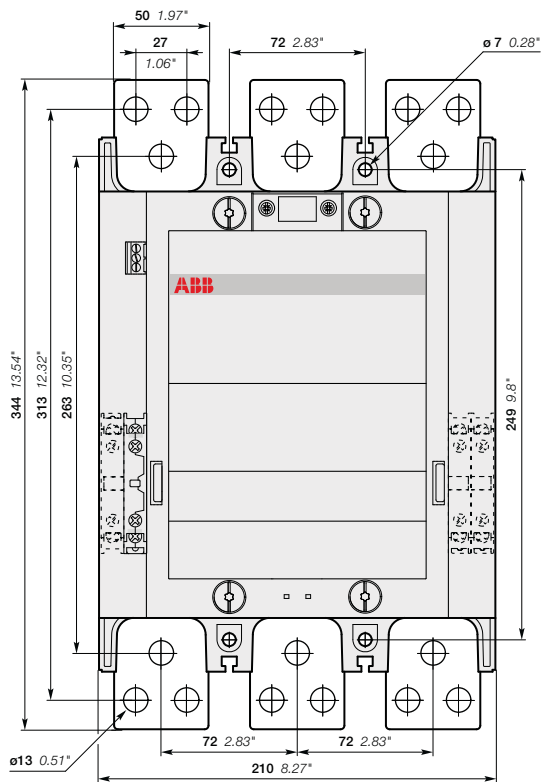

GAF1250-30-11

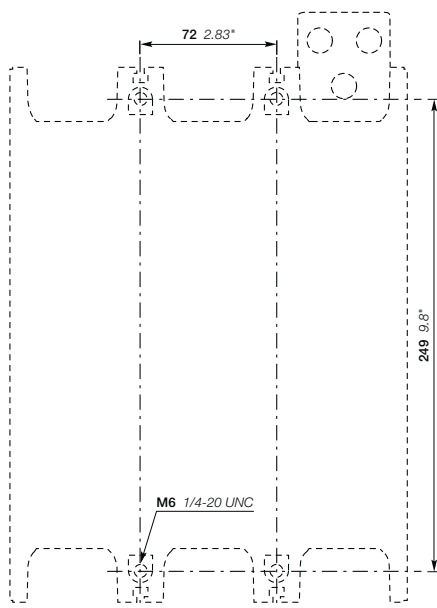

5

GAF1650, GAF2050 3-pole contactor

Main dimensions mm, inches

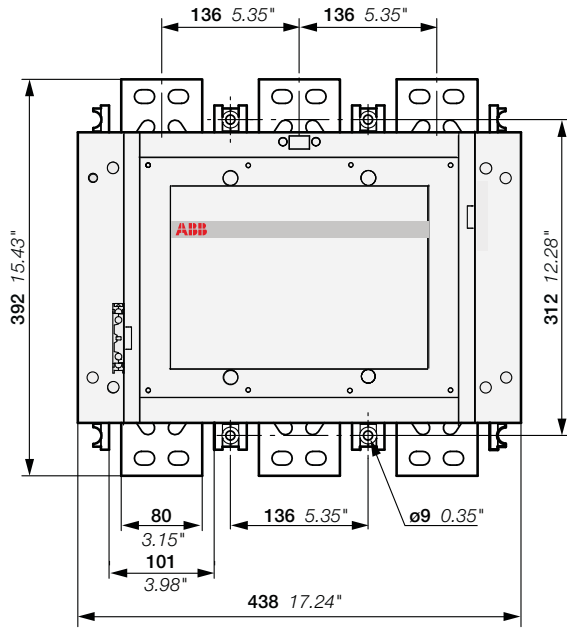
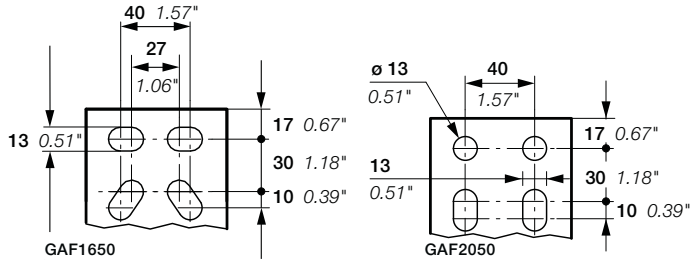

GAF1650, GAF2050-30-11

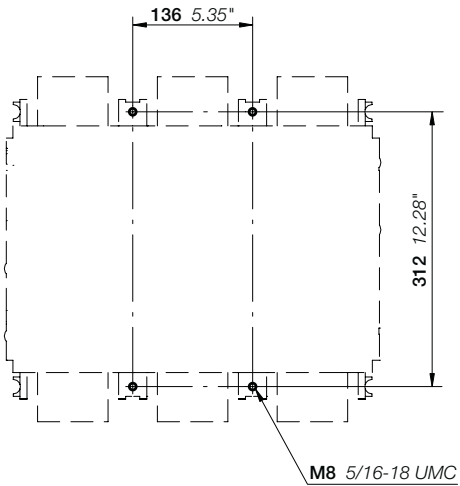
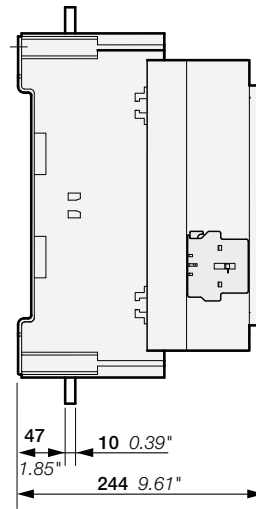



Contactors for capacitor switching

[Overview](#) [5/274](#)

[UA16..RA up to UA110..RA - Unlimited peak current \$\hat{I}\$](#)

Ordering details	5/276
Main accessories	5/279
Technical data	5/280
Terminal marking and positioning	5/282
Main dimensions	5/283

[UA16 up to UA110 - Peak current \$\hat{I} \leq 100\$ times the rms current](#)

Ordering details	5/285
Main accessories	5/290
Technical data	5/291
Terminal marking and positioning	5/293
Main dimensions	5/294

[AF 3-pole contactors for capacitor switching - Selection table](#) [5/295](#)

[Voltage code table](#) [5/410](#)

Contactors for capacitor switching

AC-6b utilization category according to IEC 60947-4-1

Capacitor transient conditions

In Low Voltage industrial installations, capacitors are mainly used for reactive energy correction (raising the power factor). When these capacitors are energized, overcurrents of high amplitude and high frequencies (3 to 15 kHz) occur during the transient period (1 to 2 ms).

The amplitude of these current peaks, also known as "inrush current peaks", depends on the following factors:

- The network inductances.
- The transformer power and short-circuit voltage.
- The type of power factor correction.

There are 2 types of power factor correction: fixed or automatic.

Fixed power factor correction consists of inserting, in parallel on the network, a capacitor bank whose total power is provided by the assembly of capacitors of identical or different ratings.

The bank is energized by a contactor that simultaneously supplies all the capacitors (a single step).

The inrush current peak, in the case of fixed correction, can reach 30 times the nominal current of the capacitor bank.



Single-step capacitor bank scheme
Use the AF... contactor ranges.

An automatic power factor correction system, on the other hand, consists of several capacitor banks of identical or different ratings (several steps), energized separately according to the value of the power factor to be corrected.

An electronic device automatically determines the power of the steps to be energized and activates the relevant contactors.

The inrush current peak, in the case of automatic correction, depends on the power of the steps already on duty, and can reach 100 times the nominal current of the step to be energized.

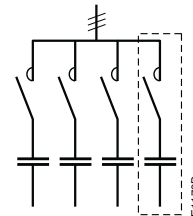

Multi-step capacitor bank scheme
Use the UA... or UA..RA contactor ranges.

Steady state condition data

The presence of harmonics and the network's voltage tolerance lead to a current, estimated to be 1.3 times the nominal current I_n of the capacitor, permanently circulating in the circuit.

Taking into account the manufacturing tolerances, the exact power of a capacitor can reach 1.15 times its nominal power.

Standard IEC 60831-1 Edition 2002 specifies that the capacitor must therefore have a maximum thermal current I_T of:

$$I_T = 1.3 \times 1.15 \times I_n = 1.5 \times I_n$$

Consequences for the contactors

To avoid malfunctions (welding of main poles, abnormal temperature rise, etc.), contactors for capacitor bank switching must be sized to withstand:

- A permanent current that can reach 1.5 times the nominal current of the capacitor bank.
- The short but high peak current on pole closing (maximum permissible peak current \hat{I}).

Contactor selection tool for capacitor switching

In a given application, if the user does not know the value of the inrush current peak, this value can be approximately calculated using the formulas given on the pages "Calculation and dimensioning".

Alternatively by the **CAPCAL selection tool**, available on the ABB Website:

www.abb.com/lowvoltage

right hand side menu

search: "Online product selection tools"

select: "Contactors: AC-6b capacitor switching"

This program allows the calculation of these peaks and gives the references of the ABB contactors according to the installation specifications. This calculation is valid for one or several capacitor banks.

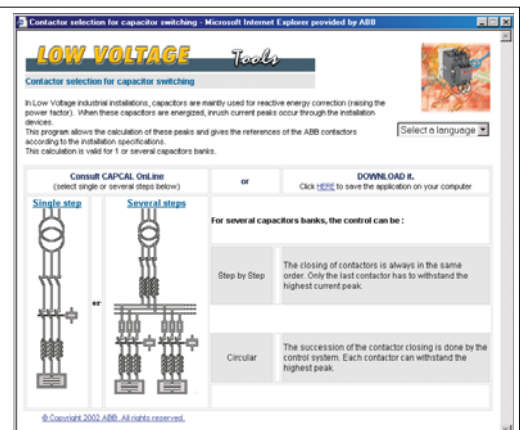

Contactors for capacitor switching

The ABB solutions

ABB offers 2 contactor versions according to the value of the inrush current peak and the power of the capacitor bank.

UA..RA contactors for capacitor switching (UA16..RA to UA110..RA) with insertion of damping resistors

The insertion of damping resistors protects the contactor and the capacitor from the highest inrush currents.

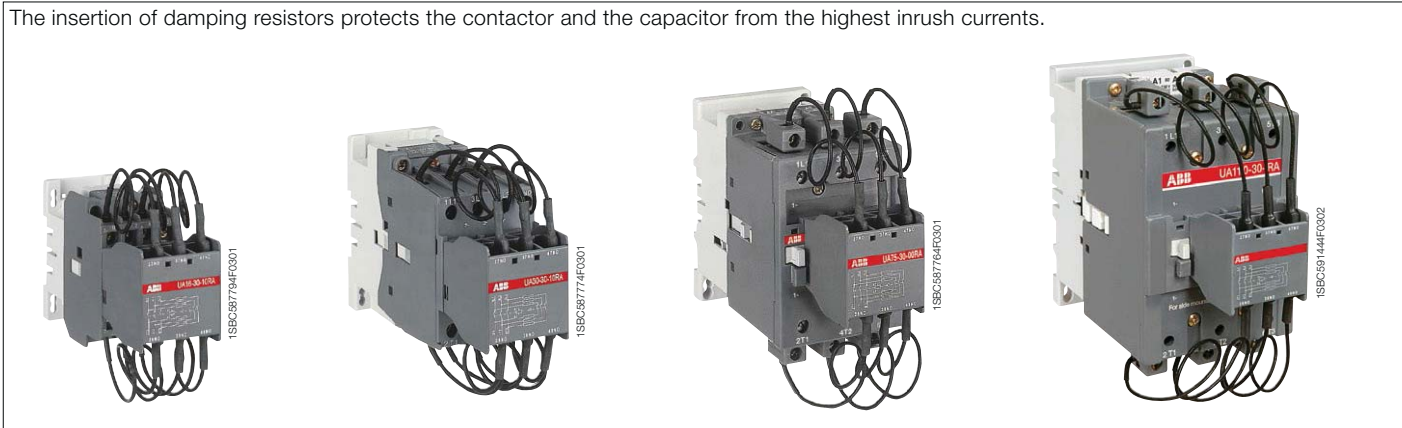

5

UA contactors for capacitor switching (UA16 to UA110)

Maximum permissible peak current $\hat{I} \leq 100$ times the nominal rms current of the switched capacitor.

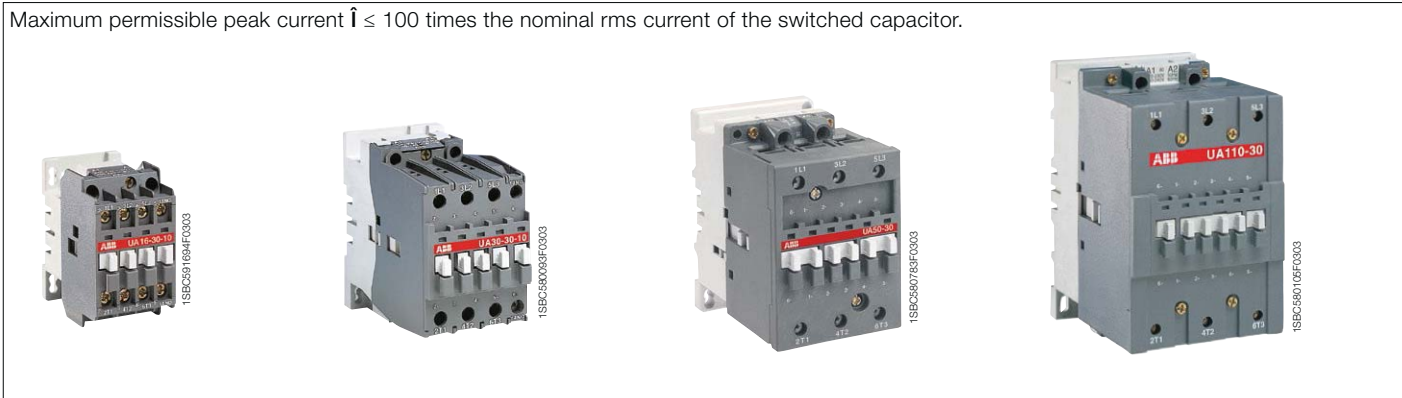

UA16..RA ... UA30..RA 3-pole contactors for capacitor switching 12.5 to 30 kvar - Unlimited peak current \hat{I} AC operated



UA16-30-10RA

1SBC87794FC001



UA30-30-10RA

1SBC87774FC001

Description

UA..RA contactors for capacitor switching can be used for installations in which the peak current far exceeds 100 times nominal rms current. The contactors are delivered complete with their damping resistors and must be used without additional inductances.

The capacitors must be discharged (maximum residual voltage at terminals ≤ 50 V) before being re-energized when the contactors are making.

These contactors are of the block type design with:

- 3 main poles and 1 built-in auxiliary contact
- the UA..RA contactors are fitted with a special front-mounted block, which ensures the serial insertion of 3 damping resistors into the circuit to limit the current peak on energization of the capacitor bank
- their connection also ensures capacitor precharging in order to limit the second current peak occurring upon making of the main poles
- the insertion of resistors allows to damp the highest current peak of the capacitor when switching on, whatever its level.
- control circuit: AC operated
- add-on auxiliary contact blocks for side mounting and a wide range of accessories.

Ordering details

IEC Rated operational power $\theta \leq 40^\circ\text{C}$ 400 V AC-6b kvar	UL/CSA Rated operational power $\theta \leq 40^\circ\text{C}$ 480 V kvar	Rated control circuit voltage U_c (1)		Auxiliary contacts fitted	Type	Order code	Weight Pkg (1 pce) kg		
		V 50 Hz	V 60 Hz						
12.5	16	24	24	1 0	UA16-30-10RA	1SBL181024R8110	0.460		
		48	48	1 0	UA16-30-10RA	1SBL181024R8310	0.460		
		110	110...120	1 0	UA16-30-10RA	1SBL181024R8410	0.460		
		220...230	230...240	1 0	UA16-30-10RA	1SBL181024R8010	0.460		
		230...240	240...260	1 0	UA16-30-10RA	1SBL181024R8810	0.460		
		380...400	400...415	1 0	UA16-30-10RA	1SBL181024R8510	0.460		
		400...415	415...440	1 0	UA16-30-10RA	1SBL181024R8610	0.460		
		22	22	24	24	1 0	UA26-30-10RA	1SBL241024R8110	0.710
		48	48	1 0	UA26-30-10RA	1SBL241024R8310	0.710		
		110	110...120	1 0	UA26-30-10RA	1SBL241024R8410	0.710		
220...230	230...240	1 0	UA26-30-10RA	1SBL241024R8010	0.710				
230...240	240...260	1 0	UA26-30-10RA	1SBL241024R8810	0.710				
380...400	400...415	1 0	UA26-30-10RA	1SBL241024R8510	0.710				
400...415	415...440	1 0	UA26-30-10RA	1SBL241024R8610	0.710				
30	28	24	24	1 0	UA30-30-10RA	1SBL281024R8110	0.810		
		48	48	1 0	UA30-30-10RA	1SBL281024R8310	0.810		
		110	110...120	1 0	UA30-30-10RA	1SBL281024R8410	0.810		
		220...230	230...240	1 0	UA30-30-10RA	1SBL281024R8010	0.810		
		230...240	240...260	1 0	UA30-30-10RA	1SBL281024R8810	0.810		
		380...400	400...415	1 0	UA30-30-10RA	1SBL281024R8510	0.810		
		400...415	415...440	1 0	UA30-30-10RA	1SBL281024R8610	0.810		

(1) Other control voltages see voltage code table.

Main dimensions mm, inches

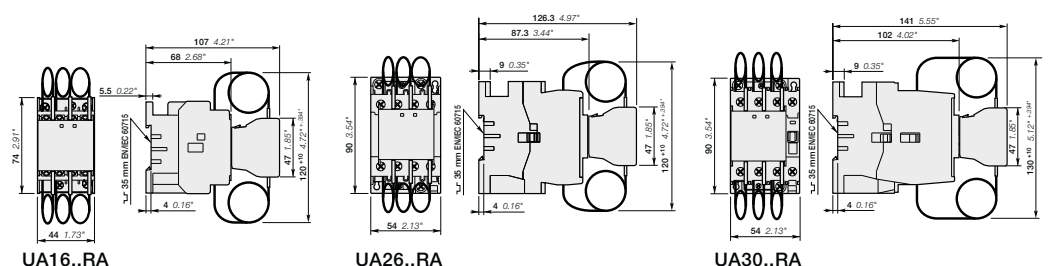

1SBC101507S0201

UA50..RA ... UA75..RA 3-pole contactors for capacitor switching 40 to 60 kvar - Unlimited peak current \hat{I} AC operated



UA75-30-00 RA

Description

UA..RA contactors for capacitor switching can be used for installations in which the peak current far exceeds 100 times nominal rms current. The contactors are delivered complete with their damping resistors and must be used without additional inductances.

The capacitors must be discharged (maximum residual voltage at terminals ≤ 50 V) before being re-energized when the contactors are making.

These contactors are of the block type design with:

- 3 main poles
- the UA..RA contactors are fitted with a special front-mounted block, which ensures the serial insertion of 3 damping resistors into the circuit to limit the current peak on energization of the capacitor bank
 - their connection also ensures capacitor precharging in order to limit the second current peak occurring upon making of the main poles
 - the insertion of resistors allows to damp the highest current peak of the capacitor when switching on, whatever its level.
- control circuit: AC operated
- add-on auxiliary contact blocks for side mounting and a wide range of accessories.

Ordering details

IEC Rated operational power $\theta \leq 40^\circ\text{C}$ 400 V AC-6b kvar	UL/CSA Rated operational power $\theta \leq 40^\circ\text{C}$ 480 V kvar	Rated control circuit voltage Uc (1)		Auxiliary contacts fitted	Type	Order code	Weight Pkg (1 pce) kg
		V 50 Hz	V 60 Hz				
40	50	24	24	0 0	UA50-30-00RA	1SBL351024R8100	1.350
		48	48	0 0	UA50-30-00RA	1SBL351024R8300	1.350
		110	110...120	0 0	UA50-30-00RA	1SBL351024R8400	1.350
		220...230	230...240	0 0	UA50-30-00RA	1SBL351024R8000	1.350
		230...240	240...260	0 0	UA50-30-00RA	1SBL351024R8800	1.350
		380...400	400...415	0 0	UA50-30-00RA	1SBL351024R8500	1.350
		400...415	415...440	0 0	UA50-30-00RA	1SBL351024R8600	1.350
50	55	24	24	0 0	UA63-30-00RA	1SBL371024R8100	1.350
		48	48	0 0	UA63-30-00RA	1SBL371024R8300	1.350
		110	110...120	0 0	UA63-30-00RA	1SBL371024R8400	1.350
		220...230	230...240	0 0	UA63-30-00RA	1SBL371024R8000	1.350
		230...240	240...260	0 0	UA63-30-00RA	1SBL371024R8800	1.350
		380...400	400...415	0 0	UA63-30-00RA	1SBL371024R8500	1.350
		400...415	415...440	0 0	UA63-30-00RA	1SBL371024R8600	1.350
60	64	24	24	0 0	UA75-30-00RA	1SBL411024R8100	1.350
		48	48	0 0	UA75-30-00RA	1SBL411024R8300	1.350
		110	110...120	0 0	UA75-30-00RA	1SBL411024R8400	1.350
		220...230	230...240	0 0	UA75-30-00RA	1SBL411024R8000	1.350
		230...240	240...260	0 0	UA75-30-00RA	1SBL411024R8800	1.350
		380...400	400...415	0 0	UA75-30-00RA	1SBL411024R8500	1.350
		400...415	415...440	0 0	UA75-30-00RA	1SBL411024R8600	1.350

(1) Other control voltages see voltage code table.

Main dimensions mm, inches

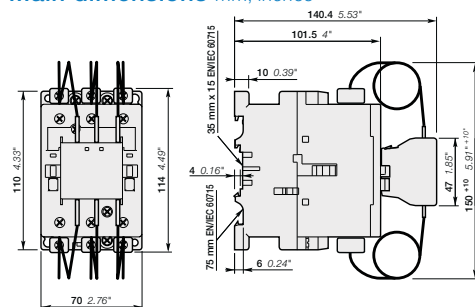

UA50..RA, UA63..RA, UA75..RA

UA95..RA ... UA110..RA 3-pole contactors for capacitor switching 70 to 80 kvar - Unlimited peak current \hat{I} AC operated



UA110-30-00 RA

Description

UA..RA contactors for capacitor switching can be used for installations in which the peak current far exceeds 100 times nominal rms current. The contactors are delivered complete with their damping resistors and must be used without additional inductances.

The capacitors must be discharged (maximum residual voltage at terminals ≤ 50 V) before being re-energized when the contactors are making.

These contactors are of the block type design with:

- 3 main poles
- the UA..RA contactors are fitted with a special front-mounted block, which ensures the serial insertion of 3 damping resistors into the circuit to limit the current peak on energization of the capacitor bank
- their connection also ensures capacitor precharging in order to limit the second current peak occurring upon making of the main poles
- the insertion of resistors allows to damp the highest current peak of the capacitor when switching on, whatever its level.
- control circuit: AC operated
- add-on auxiliary contact blocks for side mounting and a wide range of accessories.

Ordering details

IEC Rated operational power $\theta \leq 40^\circ\text{C}$ 400 V AC-6b	UL/CSA Rated operational power $\theta \leq 40^\circ\text{C}$ 480 V	Rated control circuit voltage U_c (1)		Auxiliary contacts fitted 	Type	Order code	Weight Pkg (1 pce) kg	
		V 50 Hz	V 60 Hz					
70	80	24	24	0	0	UA95-30-00RA	1SFL431024R8100	2.000
		48	48	0	0	UA95-30-00RA	1SFL431024R8300	2.000
		110	110...120	0	0	UA95-30-00RA	1SFL431024R8400	2.000
		220...230	230...240	0	0	UA95-30-00RA	1SFL431024R8000	2.000
		230...240	240...260	0	0	UA95-30-00RA	1SFL431024R8800	2.000
		380...400	400...415	0	0	UA95-30-00RA	1SFL431024R8500	2.000
80	95	400...415	415...440	0	0	UA95-30-00RA	1SFL431024R8600	2.000
		24	24	0	0	UA110-30-00RA	1SFL451024R8100	2.000
		48	48	0	0	UA110-30-00RA	1SFL451024R8300	2.000
		110	110...120	0	0	UA110-30-00RA	1SFL451024R8400	2.000
		220...230	230...240	0	0	UA110-30-00RA	1SFL451024R8000	2.000
		230...240	240...260	0	0	UA110-30-00RA	1SFL451024R8800	2.000
		380...400	400...415	0	0	UA110-30-00RA	1SFL451024R8500	2.000
		400...415	415...440	0	0	UA110-30-00RA	1SFL451024R8600	2.000

(1) Other control voltages see voltage code table.

Main dimensions mm, inches

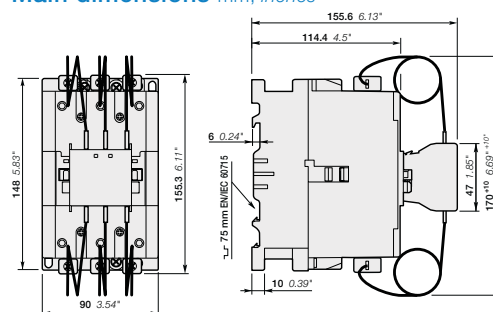





UA95..RA, UA100..RA

UA..RA 3-pole contactors for capacitor switching

Unlimited peak current \hat{I}

Main accessory fitting details

Many configurations of accessories are possible depending on whether these are front-mounted or side-mounted.

Contactor types	Main poles		Available auxiliary contacts		Front-mounted accessories	Side-mounted accessories
					Auxiliary contact blocks	Auxiliary contact blocks
					1-pole CA5-...	2-pole CAL...
UA16-30-10RA	3	0	1	0	-	1 x CAL5-11
UA26-30-10RA	3	0	1	0	-	1 to 2 x CAL5-11
UA30-30-10RA	3	0	1	0	1 x CA5-...	+ 1 to 2 x CAL5-11
UA50-30-00RA	3	0	0	0	1 to 2 x CA5-...	+ 1 to 2 x CAL5-11
UA63-30-00RA	3	0	0	0		
UA75-30-00RA	3	0	0	0		
UA95-30-00RA	3	0	0	0	1 to 2 x CA5-...	+ 1 to 2 x CAL18-11
UA110-30-00RA	3	0	0	0		

UA16..RA ... UA110..RA 3-pole contactors for capacitor switching

Unlimited peak current \hat{I}

Technical data

Main pole - Utilization characteristics according to IEC

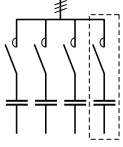
Contactor types	AC operated	UA16..RA	UA26..RA	UA30..RA	UA50..RA	UA63..RA	UA75..RA	UA95..RA	UA110..RA	
Standards		IEC 60947-1 / 60947-4-1 and EN 60947-1 / 60947-4-1								
Rated operational voltage U_e max.		690 V								
Rated frequency (without derating)		50 / 60 Hz								
AC-6b Utilization category										
Rated operational power AC-6b (1)										
For air temperature close to contactor $\theta \leq 40^\circ\text{C}$  Multi-step capacitor bank scheme	$\theta \leq 40^\circ\text{C}$	230-240 V	8 kvar	12.5 kvar	16 kvar	25 kvar	30 kvar	35 kvar	40 kvar	45 kvar
		400-415 V	12.5 kvar	22 kvar	30 kvar	40 kvar	50 kvar	60 kvar	70 kvar	80 kvar
		440 V	15 kvar	24 kvar	32 kvar	50 kvar	55 kvar	65 kvar	75 kvar	85 kvar
		500-550 V	18 kvar	30 kvar	34 kvar	55 kvar	65 kvar	75 kvar	85 kvar	95 kvar
	$\theta \leq 55^\circ\text{C}$	690 V	22 kvar	35 kvar	45 kvar	72 kvar	80 kvar	100 kvar	120 kvar	130 kvar
		230-240 V	7.5 kvar	11.5 kvar	16 kvar	24 kvar	27 kvar	30 kvar	35 kvar	40 kvar
		400-415 V	12.5 kvar	20 kvar	27.5 kvar	40 kvar	45 kvar	50 kvar	60 kvar	70 kvar
		440 V	13 kvar	20 kvar	30 kvar	43 kvar	48 kvar	53 kvar	65 kvar	75 kvar
	$\theta \leq 70^\circ\text{C}$	500-550 V	16 kvar	25 kvar	34 kvar	50 kvar	60 kvar	65 kvar	75 kvar	82 kvar
		690 V	21 kvar	31 kvar	45 kvar	65 kvar	75 kvar	80 kvar	105 kvar	110 kvar
		230-240 V	6 kvar	9 kvar	11 kvar	20 kvar	23 kvar	25 kvar	30 kvar	35 kvar
		440 V	11 kvar	17 kvar	20.5 kvar	37 kvar	42.5 kvar	45 kvar	58 kvar	70 kvar
	500-550 V	12.5 kvar	20 kvar	25 kvar	46 kvar	50 kvar	55 kvar	70 kvar	78 kvar	
	690 V	17 kvar	26 kvar	32 kvar	60 kvar	65 kvar	70 kvar	85 kvar	100 kvar	
Max. permissible peak current \hat{I}		Unlimited								
Short-circuit protection device for contactors		80 A		125 A	200 A	250 A				
gG type fuse (2)		80 A		125 A	200 A	250 A				
Max. electrical switching frequency		240 cycles/h								
Electrical durability AC-6b	$U_e \leq 440\text{ V}$	250 000 operating cycles								
	$500\text{ V} \leq U_e \leq 690\text{ V}$	100 000 operating cycles								

(1) For 220 V and 380 V, multiply by 0.9 the rated values at 230 V and 400 V respectively.

Example: 50 kvar / 400 V corresponding to $0.9 \times 50 = 45\text{ kvar}/380\text{ V}$.

(2) The fuse ratings given represent the maximum ratings ensuring type 1 coordination according to the definition of standard IEC 60947-4-1.

Main pole - Utilization characteristics according to UL / CSA

Contactor types	AC operated	UA16..RA	UA26..RA	UA30..RA	UA50..RA	UA63..RA	UA75..RA	UA95..RA	UA110..RA
Power - 60 Hz									
For air temperature close to contactor $\theta \leq 40^\circ\text{C}$	240 V	8 kvar	11 kvar	14 kvar	25 kvar	27.5 kvar	32 kvar	40 kvar	45 kvar
	480 V	16 kvar	22 kvar	28 kvar	50 kvar	55 kvar	64 kvar	80 kvar	95 kvar
	600 V	20 kvar	27 kvar	35 kvar	62 kvar	70 kvar	80 kvar	100 kvar	120 kvar
Max. permissible peak Current \hat{I}		Unlimited							

Operating principle

The front-mounted block mechanism of the UA..RA contactors ensures:

- early making of the auxiliary "PA" poles with respect to the main "PP" poles
- automatic return to the open position of the auxiliary "PA" poles after the main poles are closed.

When the coil is energized, the early making auxiliary poles connect the capacitor to the network via the set of 3 resistors. The damping resistors attenuate the first current peak and the second inrush current when the main contacts begin to make. Once the main poles are in the closed position, the auxiliary poles automatically break.

When the coil is de-energized, the main poles break ensuring the breaking of the capacitor bank.

The contactor can then begin a new cycle.

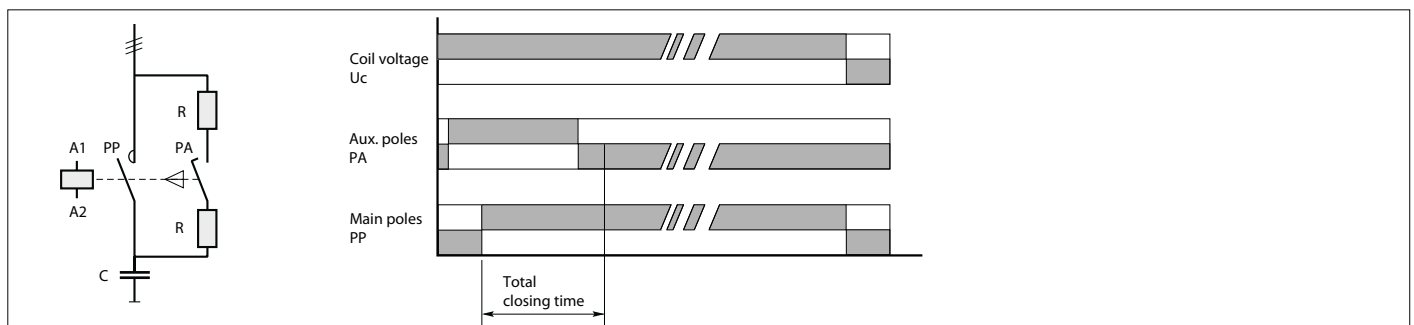







The insertion of resistors allows to damp the highest current peak of the capacitor when switching on, whatever its level.

UA16..RA ... UA110..RA 3-pole contactors for capacitor switching

Unlimited peak current \hat{I}

Technical data

Connecting characteristics

Contactor types	AC operated	UA16..RA	UA26..RA	UA30..RA	UA50..RA UA63..RA UA75..RA	UA95..RA UA110..RA
Connection capacity (min. ... max.)						
Main conductors (poles)						
 Rigid	Solid ($\leq 4 \text{ mm}^2$)	1 x 1...4 mm ²	1.5...6 mm ²	2.5...16 mm ²	6...50 mm ²	10...95 mm ²
	Stranded ($\geq 6 \text{ mm}^2$)	2 x -	-	2.5...16 + 2.5...6 mm ²	6...25 + 6...16 mm ²	6...35 mm ²
 Flexible with ferrule		1 x 0.75...2.5 mm ²	1.5...4 mm ²	2.5...10 mm ²	6...35 mm ²	10...70 mm ²
		2 x -	-	2.5...10 + 2.5...4 mm ²	6...16 + 6...10 mm ²	6...35 mm ²
 Bars or lugs		L \leq 7.7 mm	10 mm	-	-	-
		I $>$ 3.7 mm	4.2 mm	-	-	-
Connection capacity acc. to UL/CSA		1 or 2 x AWG 18...10	AWG 12...8	AWG 8...4	AWG 8...1	AWG 6...2/0
Tightening torque						
	Recommended	1 Nm / 9 lb.in	1.7 Nm / 15 lb.in	2.3 Nm / 20 lb.in	4 Nm / 35 lb.in	8 Nm / 53 lb.in
	Max.	1.2 Nm	2.2 Nm	2.6 Nm	4.5 Nm	9 Nm
Auxiliary conductors (built-in auxiliary terminals + coil terminals)						
 Rigid solid		1 x 1...4 mm ²				0.75...2.5 mm ²
		2 x 1...4 mm ²				0.75...2.5 mm ²
 Flexible with ferrule		1 x 0.75...2.5 mm ²			1...2.5 mm ²	0.75...2.5 mm ²
		2 x 0.75...2.5 mm ²				
 Lugs	Coil terminals	L \leq 8 mm				
		I $>$ 3.7 mm				
	Built-in auxiliary terminals	L \leq 7.7 mm	10 mm	8 mm	-	-
		I $>$ 3.7 mm	4.2 mm	3.7 mm	-	-
Connection capacity acc. to UL/CSA		1 or 2 x AWG 18...14				
Tightening torque						
	Coil terminals					
	Recommended	1 Nm / 9 lb.in				
	Max.	1.2 Nm				
	Built-in auxiliary terminals					
	Recommended	1 Nm / 9 lb.in				
	Max.	1.2 Nm				
Degree of protection acc. to IEC 60947-1 / EN 60947-1 and IEC 60529 / EN 60529						
Main terminals		IP20		IP10		
Coil terminals		IP20				
Built-in auxiliary terminals		IP20				
Screw terminals						
Main terminals		Delivered in open position, screws of unused terminals must be tightened				
		M 3.5	M 4	M 5	M 6	M 8
	Screwdriver type	Flat \varnothing 5.5 / Pozidriv 2		Flat \varnothing 6.5 / Pozidriv 2		Hexagon socket (s = 4 mm)
Coil terminals		M 3.5				
	Screwdriver type	Flat \varnothing 5.5 / Pozidriv 2				
Built-in auxiliary terminals		M 3.5	M 4	M 3.5	-	-
	Screwdriver type	Flat \varnothing 5.5 / Pozidriv 2		-		

Other technical characteristics are the same as those of standard A contactors.

UA..RA contactors

Terminal marking and positioning

UA..RA contactors - AC operated

Standard devices without addition of auxiliary contacts

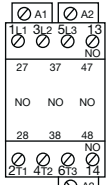

UA16-30-10 RA
UA26-30-10 RA

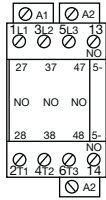

UA30-30-10 RA

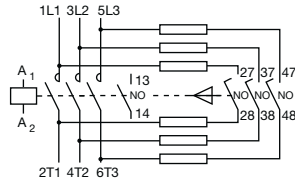

UA16 ... 30-30-10 RA

5

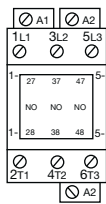

UA50 ... 110-30-00 RA

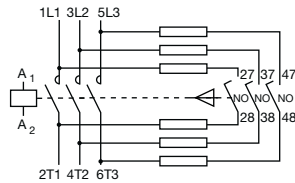

UA50 ... 110-30-00 RA

UA..RA 3-pole contactors for capacitor switching

Unlimited peak current \hat{I}

Main dimensions mm, inches

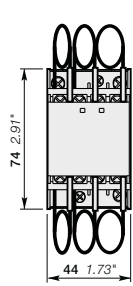

UA16..RA

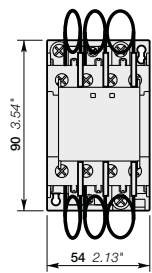
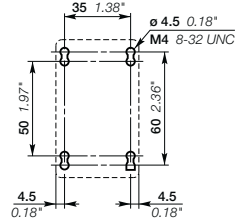
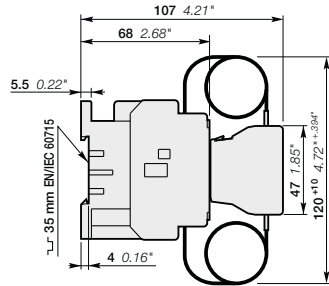

UA26..RA

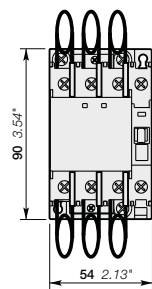
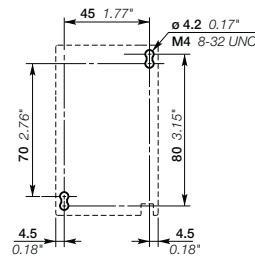
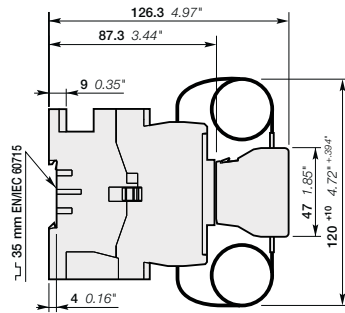

UA30..RA

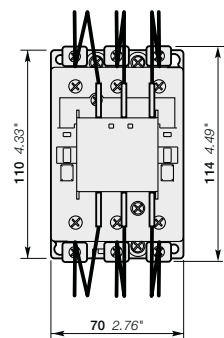
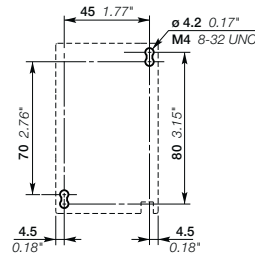
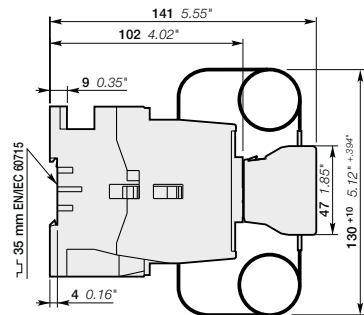

UA50..RA, UA63..RA, UA75..RA

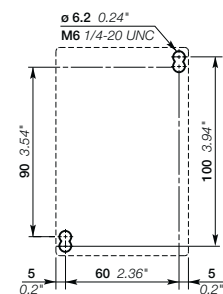
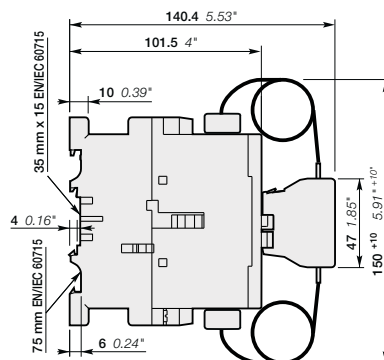

UA..RA 3-pole contactors for capacitor switching

Unlimited peak current \hat{I}

Main dimensions mm, inches

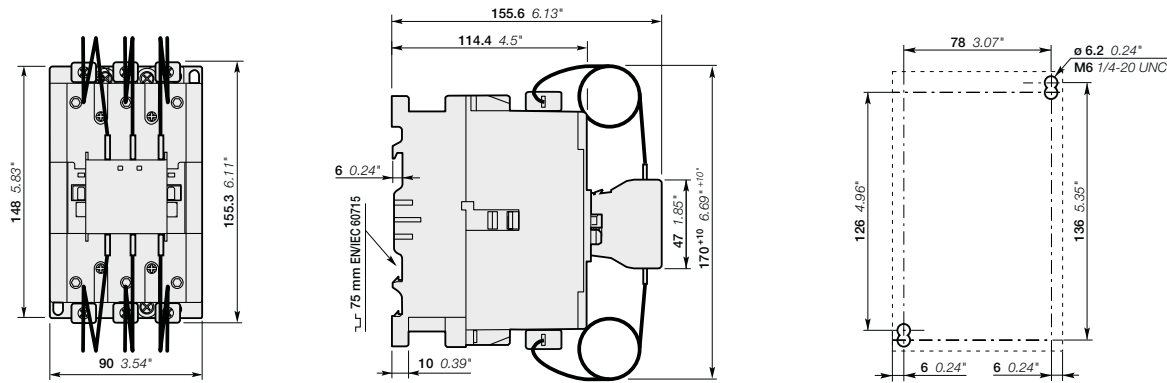

UA95..RA, UA110..RA

5

UA16 ... UA30 3-pole contactors for capacitor switching

12.5 to 27.5 kvar - Peak current $\hat{I} \leq 100$ times the rms current

AC operated



UA16-30-10



UA30-30-10

Description

UA contactors can be used for the switching of capacitor banks whose inrush current peaks are less than or equal to 100 times nominal rms current.

The capacitors must be discharged (maximum residual voltage at terminals ≤ 50 V) before being re-energized when the contactors are making.

These contactors are of the block type design with:

- 3 main poles and 1 built-in auxiliary contact
- control circuit: AC operated
- add-on auxiliary contact blocks for front or side mounting and a wide range of accessories.

Ordering details

IEC Rated operational power $\theta \leq 40^\circ\text{C}$ 400 V AC-6b	Max peak current \hat{I} kA	UL/CSA Rated operational power $\theta \leq 40^\circ\text{C}$ 480 V	Rated control circuit voltage U_c (1)		Auxiliary contacts fitted 	Type	Order code	Weight kg
			V 50 Hz	V 60 Hz				
12.5	1.8	-	24	24	1 0	UA16-30-10	1SBL181022R8110	0.340
			48	48	1 0	UA16-30-10	1SBL181022R8310	0.340
			110	110...120	1 0	UA16-30-10	1SBL181022R8410	0.340
			220...230	230...240	1 0	UA16-30-10	1SBL181022R8010	0.340
			230...240	240...260	1 0	UA16-30-10	1SBL181022R8810	0.340
			380...400	400...415	1 0	UA16-30-10	1SBL181022R8510	0.340
			400...415	415...440	1 0	UA16-30-10	1SBL181022R8610	0.340
20	3	25	24	24	1 0	UA26-30-10	1SBL241022R8110	0.600
			48	48	1 0	UA26-30-10	1SBL241022R8310	0.600
			110	110...120	1 0	UA26-30-10	1SBL241022R8410	0.600
			220...230	230...240	1 0	UA26-30-10	1SBL241022R8010	0.600
			230...240	240...260	1 0	UA26-30-10	1SBL241022R8810	0.600
			380...400	400...415	1 0	UA26-30-10	1SBL241022R8510	0.600
			400...415	415...440	1 0	UA26-30-10	1SBL241022R8610	0.600
27.5	3.5	32	24	24	1 0	UA30-30-10	1SBL281022R8110	0.710
			48	48	1 0	UA30-30-10	1SBL281022R8310	0.710
			110	110...120	1 0	UA30-30-10	1SBL281022R8410	0.710
			220...230	230...240	1 0	UA30-30-10	1SBL281022R8010	0.710
			230...240	240...260	1 0	UA30-30-10	1SBL281022R8810	0.710
			380...400	400...415	1 0	UA30-30-10	1SBL281022R8510	0.710
			400...415	415...440	1 0	UA30-30-10	1SBL281022R8610	0.710

(1) Other control voltages see voltage code table.

Main dimensions mm, inches

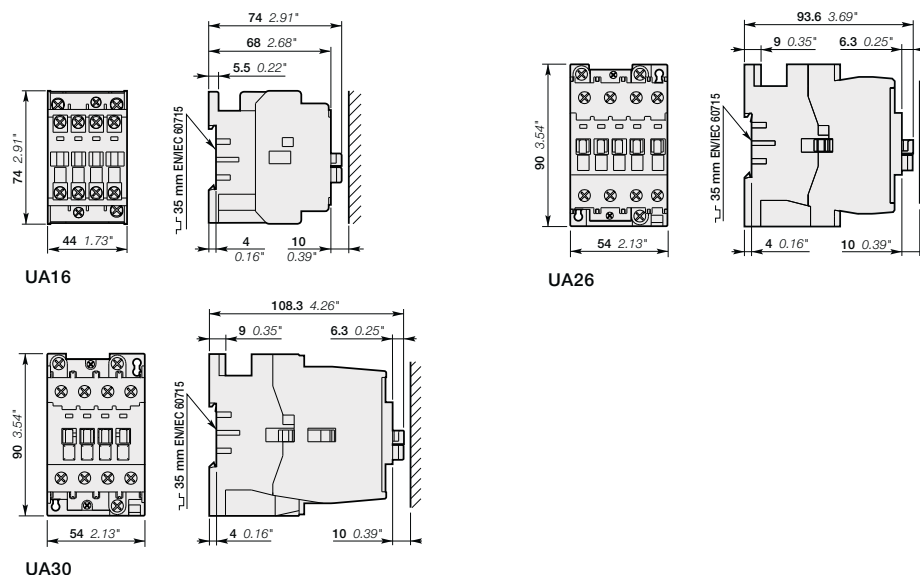

UA50 ... UA75 3-pole contactors for capacitor switching 33 to 50 kvar - Peak current $\hat{I} \leq 100$ times the rms current AC operated



UA50-30-00

Description

UA contactors can be used for the switching of capacitor banks whose inrush current peaks are less than or equal to 100 times nominal rms current.
The capacitors must be discharged (maximum residual voltage at terminals ≤ 50 V) before being re-energized when the contactors are making.
These contactors are of the block type design with:

- 3 main poles
- control circuit: AC operated
- add-on auxiliary contact blocks for front or side mounting and a wide range of accessories.

Ordering details

IEC Rated operational power $\theta \leq 40^\circ\text{C}$ 400 V AC-6b	Max peak current \hat{I} kA	UL/CSA Rated operational power $\theta \leq 40^\circ\text{C}$ 480 V	Rated control circuit voltage U_c (1)		Auxiliary contacts fitted 	Type	Order code	Weight Pkg (1 pce) kg
			V 50 Hz	V 60 Hz				
33	5	40	24	24	0 0	UA50-30-00	1SBL351022R8100	1.160
			48	48	0 0	UA50-30-00	1SBL351022R8300	1.160
			110	110...120	0 0	UA50-30-00	1SBL351022R8400	1.160
			220...230	230...240	0 0	UA50-30-00	1SBL351022R8000	1.160
			230...240	240...260	0 0	UA50-30-00	1SBL351022R8800	1.160
			380...400	400...415	0 0	UA50-30-00	1SBL351022R8500	1.160
			400...415	415...440	0 0	UA50-30-00	1SBL351022R8600	1.160
45	6.5	-	24	24	0 0	UA63-30-00	1SBL371022R8100	1.160
			48	48	0 0	UA63-30-00	1SBL371022R8300	1.160
			110	110...120	0 0	UA63-30-00	1SBL371022R8400	1.160
			220...230	230...240	0 0	UA63-30-00	1SBL371022R8000	1.160
			230...240	240...260	0 0	UA63-30-00	1SBL371022R8800	1.160
			380...400	400...415	0 0	UA63-30-00	1SBL371022R8500	1.160
			400...415	415...440	0 0	UA63-30-00	1SBL371022R8600	1.160
50	7.5	55	24	24	0 0	UA75-30-00	1SBL411022R8100	1.160
			48	48	0 0	UA75-30-00	1SBL411022R8300	1.160
			110	110...120	0 0	UA75-30-00	1SBL411022R8400	1.160
			220...230	230...240	0 0	UA75-30-00	1SBL411022R8000	1.160
			230...240	240...260	0 0	UA75-30-00	1SBL411022R8800	1.160
			380...400	400...415	0 0	UA75-30-00	1SBL411022R8500	1.160
			400...415	415...440	0 0	UA75-30-00	1SBL411022R8600	1.160

(1) Other control voltages see voltage code table.

Main dimensions mm, inches

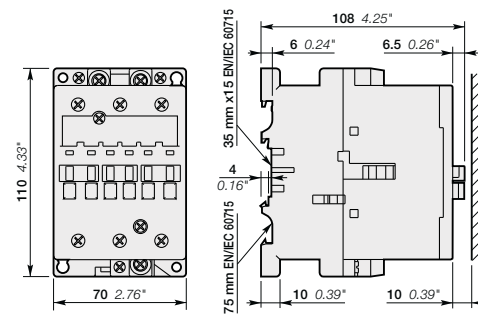

UA50, UA63, UA75

UA50 ... UA75 3-pole contactors for capacitor switching

33 to 50 kvar - Peak current $\hat{I} < 100$ Times the rms current

AC operated - with 1 N.O. + 1 N.C. auxiliary contacts



UA50-30-11

Description

UA contactors can be used for the switching of capacitor banks whose inrush current peaks are less than or equal to 100 times nominal rms current.

The capacitors must be discharged (maximum residual voltage at terminals ≤ 50 V) before being re-energized when the contactors are making.

These contactors are of the block type design with:

- 3 main poles
- control circuit: AC operated
- add-on auxiliary contact blocks for front or side mounting and a wide range of accessories.

Ordering details

IEC Rated operational power $\theta \leq 40^\circ\text{C}$ 400 V AC-6b kvar	Max peak current \hat{I} kA	UL/CSA Rated operational power $\theta \leq 40^\circ\text{C}$ 400 V kvar	Rated control circuit voltage U_c (1)		Auxiliary contacts fitted	Type	Order code	Weight Pkg (1 pce) kg
			V 50 Hz	V 60 Hz				
33	5	40	24	24	1 1	UA50-30-11	1SBL351022R8111	1.200
			48	48	1 1	UA50-30-11	1SBL351022R8311	1.200
			110	110...120	1 1	UA50-30-11	1SBL351022R8411	1.200
			220...230	230...240	1 1	UA50-30-11	1SBL351022R8011	1.200
			230...240	240...260	1 1	UA50-30-11	1SBL351022R8811	1.200
			380...400	400...415	1 1	UA50-30-11	1SBL351022R8511	1.200
			400...415	415...440	1 1	UA50-30-11	1SBL351022R8611	1.200
45	6.5	-	24	24	1 1	UA63-30-11	1SBL371022R8111	1.200
			48	48	1 1	UA63-30-11	1SBL371022R8311	1.200
			110	110...120	1 1	UA63-30-11	1SBL371022R8411	1.200
			220...230	230...240	1 1	UA63-30-11	1SBL371022R8011	1.200
			230...240	240...260	1 1	UA63-30-11	1SBL371022R8811	1.200
			380...400	400...415	1 1	UA63-30-11	1SBL371022R8511	1.200
			400...415	415...440	1 1	UA63-30-11	1SBL371022R8611	1.200
50	7.5	55	24	24	1 1	UA75-30-11	1SBL411022R8111	1.200
			48	48	1 1	UA75-30-11	1SBL411022R8311	1.200
			110	110...120	1 1	UA75-30-11	1SBL411022R8411	1.200
			220...230	230...240	1 1	UA75-30-11	1SBL411022R8011	1.200
			230...240	240...260	1 1	UA75-30-11	1SBL411022R8811	1.200
			380...400	400...415	1 1	UA75-30-11	1SBL411022R8511	1.200
			400...415	415...440	1 1	UA75-30-11	1SBL411022R8611	1.200

(1) Other control voltages see voltage code table.

Main dimensions mm, inches

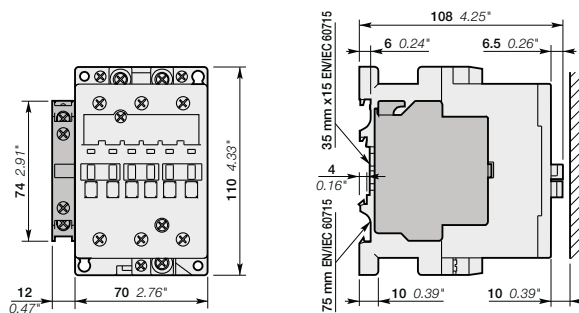

UA50, UA63, UA75 with 1 N.O. + 1 N.C. auxiliary contacts

UA95 ... UA110 3-pole contactors for capacitor switching 65 to 75 kvar - Peak current $\hat{i} \leq 100$ times the rms current AC operated



UA110-30-00

Description

UA contactors can be used for the switching of capacitor banks whose inrush current peaks are less or equal to 100 times nominal rms current. The capacitors must be discharged (maximum residual voltage at terminals ≤ 50 V) before being re-energized when the contactors are making.

These contactors are of the block type design with:

- 3 main poles
- control circuit: AC operated
- add-on auxiliary contact blocks for front or side mounting and a wide range of accessories.

Ordering details

IEC Rated operational power $\theta \leq 40^\circ\text{C}$ 400 V AC-6b kvar	Max peak current \hat{i} kA	UL/CSA Rated operational power $\theta \leq 40^\circ\text{C}$ 480 V kvar	Rated control circuit voltage U_c (1)		Auxiliary contacts fitted Y Z	Type	Order code	Weight Pkg (1 pce) kg
			V 50 Hz	V 60 Hz				
65	9.3	70	24	24	0 0	UA95-30-00	1SFL431022R8100	2.000
			48	48	0 0	UA95-30-00	1SFL431022R8300	2.000
			110	110...120	0 0	UA95-30-00	1SFL431022R8400	2.000
			220...230	230...240	0 0	UA95-30-00	1SFL431022R8000	2.000
			230...240	240...260	0 0	UA95-30-00	1SFL431022R8800	2.000
			380...400	400...415	0 0	UA95-30-00	1SFL431022R8500	2.000
			400...415	415...440	0 0	UA95-30-00	1SFL431022R8600	2.000
75	10.5	80	24	24	0 0	UA110-30-00	1SFL451022R8100	2.000
			48	48	0 0	UA110-30-00	1SFL451022R8300	2.000
			110	110...120	0 0	UA110-30-00	1SFL451022R8400	2.000
			220...230	230...240	0 0	UA110-30-00	1SFL451022R8000	2.000
			230...240	240...260	0 0	UA110-30-00	1SFL451022R8800	2.000
			380...400	400...415	0 0	UA110-30-00	1SFL451022R8500	2.000
			400...415	415...440	0 0	UA110-30-00	1SFL451022R8600	2.000

(1) Other control voltages see voltage code table.

Main dimensions mm, inches

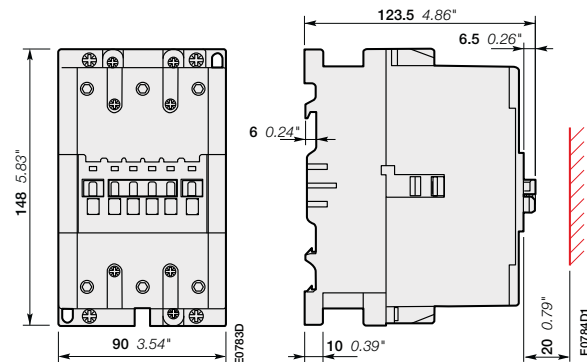

UA95, UA110

UA95 ... UA110 3-pole contactors for capacitor switching 65 to 75 kvar - Peak current $\hat{I} < 100$ times the rms current AC operated with 1 N.O. + 1 N.C. auxiliary contacts



1SFC580105FC033

UA110-30-11

Description

UA contactors can be used for the switching of capacitor banks whose inrush current peaks are less or equal to 100 times nominal rms current.
The capacitors must be discharged (maximum residual voltage at terminals ≤ 50 V) before being re-energized when the contactors are making.
These contactors are of the block type design with:

- 3 main poles
- control circuit: AC operated
- add-on auxiliary contact blocks for front or side mounting and a wide range of accessories

Ordering details

IEC Rated operational power AC-6b $\theta \leq 40^\circ\text{C}$ 400 V kvar	Max peak current \hat{I} kA	UL/CSA Rated operational power 40 °C 400 V kvar	Rated control circuit voltage Uc (1)		Auxiliary contacts fitted 	Type	Order code	Weight Pkg (1 pce) kg
			V 50 Hz	V 60 Hz				
65	9.3	70	24	24	1 1	UA95-30-11	1SFL431022R8111	2.040
			48	48	1 1	UA95-30-11	1SFL431022R8311	2.040
			110	110...120	1 1	UA95-30-11	1SFL431022R8411	2.040
			220...230	230...240	1 1	UA95-30-11	1SFL431022R8011	2.040
			230...240	240...260	1 1	UA95-30-11	1SFL431022R8811	2.040
			380...400	400...415	1 1	UA95-30-11	1SFL431022R8511	2.040
			400...415	415...440	1 1	UA95-30-11	1SFL431022R8611	2.040
75	10.5	80	24	24	1 1	UA110-30-11	1SFL451022R8111	2.040
			48	48	1 1	UA110-30-11	1SFL451022R8311	2.040
			110	110...120	1 1	UA110-30-11	1SFL451022R8411	2.040
			220...230	230...240	1 1	UA110-30-11	1SFL451022R8011	2.040
			230...240	240...260	1 1	UA110-30-11	1SFL451022R8811	2.040
			380...400	400...415	1 1	UA110-30-11	1SFL451022R8511	2.040
			400...415	415...440	1 1	UA110-30-11	1SFL451022R8611	2.040

(1) Other control voltages see voltage code table.

Main dimensions mm, inches

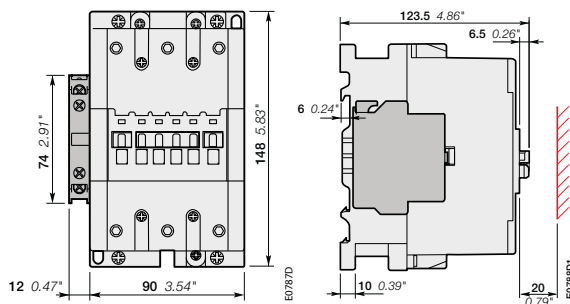

UA95, UA110

UA... 3-pole contactors for capacitor switching

Peak current $\hat{I} \leq 100$ times the rms current

Main accessory fitting details

Many configurations of accessories are possible depending on whether these are front-mounted or side-mounted.

Contactor types	Main poles	Available auxiliary contacts	Front-mounted accessories		Pneumatic timer	Side-mounted accessories
			Auxiliary contact blocks			Auxiliary contact blocks
			1-pole CA5-..	4-pole CA5-..	TP.. A	2-pole CAL...
UA16-30-10	3	0	1 to 4 x CA5-..	or 1 x CA5-.. (4-pole)	or 1 x TP.. A	+ 1 to 2 x CAL5-11
UA26-30-10	3	0	1 to 4 x CA5-..	or 1 x CA5-.. (4-pole)	or 1 x TP.. A	+ 1 to 2 x CAL5-11
UA30-30-10	3	0	1 to 5 x CA5-..	or 1 x CA5-.. (4-pole) + 1 x 1-pole CA5-..	or 1 x TP.. A + 1 x CA5-.. (1-pole)	+ 1 to 2 x CAL5-11
UA50-30-00	3	0	1 to 6 x CA5-..	or 1 x CA5-.. (4-pole) + 2 x 1-pole CA5-..	or 1 x TP.. A + 2 x CA5-.. (1-pole)	+ 1 to 2 x CAL5-11
UA63-30-00	3	0				
UA75-30-00	3	0				
UA95-30-00	3	0	1 to 6 x CA5-..	or 1 x CA5-.. (4-pole) + 2 x 1-pole CA5-..	-	+ 1 to 2 x CAL18-11
UA110-30-00	3	0				

UA16 ... UA110 3-pole contactors for capacitor switching

Peak current $\hat{I} \leq 100$ times the rms current

Technical data

Main pole - Utilization characteristics according to IEC

Contactor types	AC operated	UA16	UA26	UA30	UA50	UA63	UA75	UA95	UA110	
Standards		IEC 60947-1 / 60947-4-1 and EN 60947-1 / 60947-4-1								
Rated operational voltage U_e max.		690 V								
Rated frequency (without derating)		50 / 60 Hz								
AC-6b Utilization category										
Rated operational power AC-6b (1)										
For air temperature close to contactor	$\theta \leq 40^\circ\text{C}$	230-240 V	7.5 kvar	12 kvar	16 kvar	20 kvar	25 kvar	30 kvar	35 kvar	40 kvar
		400-415 V	12.5 kvar	20 kvar	27.5 kvar	33 kvar	45 kvar	50 kvar	65 kvar	75 kvar
	$\theta \leq 55^\circ\text{C}$	440 V	13.7 kvar	22 kvar	30 kvar	36 kvar	50 kvar	55 kvar	65 kvar	75 kvar
		500-550 V	15.5 kvar	22 kvar	34 kvar	40 kvar	50 kvar	62 kvar	70 kvar	80 kvar
	$\theta \leq 70^\circ\text{C}$	690 V	21.5 kvar	30 kvar	45 kvar	55 kvar	70 kvar	75 kvar	80 kvar	90 kvar
		230-240 V	6.7 kvar	11 kvar	16 kvar	20 kvar	25 kvar	30 kvar	35 kvar	40 kvar
		400-415 V	11.7 kvar	18.5 kvar	27.5 kvar	33 kvar	43 kvar	50 kvar	65 kvar	70 kvar
		440 V	13 kvar	20 kvar	30 kvar	36 kvar	48 kvar	53 kvar	65 kvar	75 kvar
		500-550 V	14.7 kvar	22 kvar	34 kvar	40 kvar	50 kvar	62 kvar	70 kvar	80 kvar
		690 V	20 kvar	30 kvar	45 kvar	55 kvar	70 kvar	75 kvar	80 kvar	90 kvar
		230-240 V	6 kvar	8.5 kvar	11 kvar	19 kvar	21 kvar	22 kvar	30 kvar	35 kvar
		400-415 V	10 kvar	14.5 kvar	19 kvar	32 kvar	37 kvar	39 kvar	55 kvar	65 kvar
		440 V	11 kvar	16 kvar	20 kvar	35 kvar	41 kvar	43 kvar	55 kvar	70 kvar
		500-550 V	12.5 kvar	19.5 kvar	23.5 kvar	40 kvar	45 kvar	47.5 kvar	60 kvar	75 kvar
		690 V	17 kvar	25 kvar	32 kvar	52 kvar	60 kvar	65 kvar	70 kvar	85 kvar
		Ue \leq 500 V	1.8 kA	3 kA	3.5 kA	5 kA	6.5 kA	7.5 kA	9.3 kA	10.5 kA
Max. permissible peak current \hat{I}		Ue > 500 V	1.6 kA	2.7 kA	3.1 kA	4.5 kA	5.8 kA	6.75 kA	8 kA	9 kA

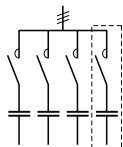

Multi-step capacitor bank scheme

5

Short-circuit protection device for contactors

gG type fuse sized 1.5...1.8 I_n of the capacitor

Max. electrical switching frequency

240 cycles/h

Electrical durability AC-6b

Ue \leq 690 V : 100 000 operating cycles

(1) For 220 V and 380 V, multiply by 0.9 the rated values at 230 V and 400 V respectively.

Example: 50 kvar / 400 V corresponding to 0.9 x 50 = 45 kvar/380 V.

If, in an application, the current peak is greater than the maximum peak current \hat{I} specified in the tables above, select a higher rating, refer to the UA..RA contactors, or add inductances. (see application guide "Contactors for capacitor switching").

Main pole - Utilization characteristics according to UL / CSA

Contactor types	AC operated	UA16	UA26	UA30	UA50	UA63	UA75	UA95	UA110	
Power - 60 Hz										
For air temperature close to contactor	$\theta \leq 40^\circ\text{C}$	240 V	-	12.5 kvar	16 kvar	20 kvar	-	27.5 kvar	35 kvar	40 kvar
		480 V	-	25 kvar	32 kvar	40 kvar	-	55 kvar	70 kvar	80 kvar
		600 V	-	30 kvar	40 kvar	50 kvar	-	70 kvar	75 kvar	85 kvar







If, in an application, the current peak is greater than the maximum peak current \hat{I} specified in the tables above, select a higher rating, refer to the UA..RA contactors, or add inductances. (see application guide "Contactors for capacitor switching").

UA16 ... UA110 3-pole contactors for capacitor switching

Peak current $\hat{I} \leq 100$ times the rms current

Technical data

Connecting characteristics

Contactor types		AC operated	UA16	UA26	UA30	UA50 UA63 UA75	UA95 UA110
Connection capacity (min. ... max.)							
Main conductors (poles)							
	Rigid	Solid ($\leq 4 \text{ mm}^2$)	1 x 1...4 mm ²	1.5...6 mm ²	2.5...16 mm ²	6...50 mm ²	10...95 mm ²
		Stranded ($\geq 6 \text{ mm}^2$)	2 x 1...4 mm ²	1.5...6 mm ²	2.5...16 mm ²	6...25 mm ²	6...35 mm ²
	Flexible with ferrule		1 x 0.75...2.5 mm ²	0.75...4 mm ²	2.5...10 mm ²	6...35 mm ²	10...70 mm ²
			2 x 0.75...2.5 mm ²	0.75...4 mm ²	2.5...10 mm ²	6...16 mm ²	6...35 mm ²
	Bars or lugs		L \leq 7.7 mm	10 mm	-	-	-
			L $>$ 3.7 mm	4.2 mm	-	-	-
Connection capacity acc. to UL/CSA			1 or 2 x AWG 18...10	AWG 12...8	AWG 8...4	AWG 8...1	AWG 6...2/0
Tightening torque		Recommended	1 Nm / 9 lb.in	1.7 Nm / 15 lb.in	2.3 Nm / 20 lb.in	4 Nm / 35 lb.in	8 Nm / 71 lb.in
		Max.	1.2 Nm	2.2 Nm	2.6 Nm	4.5 Nm	9 Nm
Auxiliary conductors (built-in auxiliary terminals + coil terminals)							
	Rigid solid		1 x 1...4 mm ²				0.75...2.5 mm ²
			2 x 1...4 mm ²				0.75...2.5 mm ²
	Flexible with ferrule		1 x 0.75...2.5 mm ²			1...2.5 mm ²	0.75...2.5 mm ²
			2 x 0.75...2.5 mm ²				
	Lugs	Coil terminals	L \leq 8 mm				
			L $>$ 3.7 mm				
		Built-in auxiliary terminals	L \leq 7.7 mm	10 mm	8 mm	-	-
			L $>$ 3.7 mm	4.2 mm	3.7 mm	-	-
Connection capacity acc. to UL/CSA			AWG 18...14				
Tightening torque							
Coil terminals		Recommended	1 Nm / 9 lb.in				
		Max.	1.2 Nm				
Built-in auxiliary terminals		Recommended	1 Nm / 9 lb.in				
		Max.	1.2 Nm				
Degree of protection acc. to IEC 60947-1 / EN 60947-1 and IEC 60529 / EN 60529							
Main terminals			IP20			IP10	
Coil terminals			IP20			-	-
Built-in auxiliary terminals			IP20			-	-
Screw terminals							
Main terminals			M3.5	M4	M5	M6	M8
		Screwdriver type	Flat \varnothing 5.5 / Pozidriv 2		Flat \varnothing 6.5 / Pozidriv 2		Hexagon socket (s = 4 mm)
Coil terminals			M3.5				
		Screwdriver type	Flat \varnothing 5.5 / Pozidriv 2				
Built-in auxiliary terminals			M3.5	M4	M3.5	-	-
		Screwdriver type	Flat \varnothing 5.5 / Pozidriv 2				

Other technical characteristics are the same as those of standard A contactors.

UA... contactors

Terminal marking and positioning

UA... contactors - AC operated

Standard devices without addition of auxiliary contacts

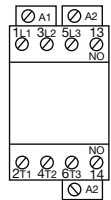

UA16 ... UA30-30-10

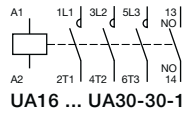

UA16 ... UA30-30-10

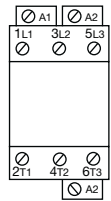

UA50 ... UA110-30-00

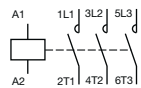

UA50 ... UA110-30-00

Standard devices with factory mounted auxiliary contacts

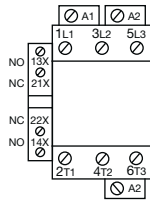

UA50 ... UA110-30-11

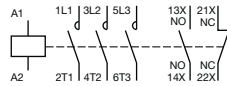

UA50 ... UA110-30-11

UA.. 3-pole contactors for capacitor switching

Main dimensions mm, inches

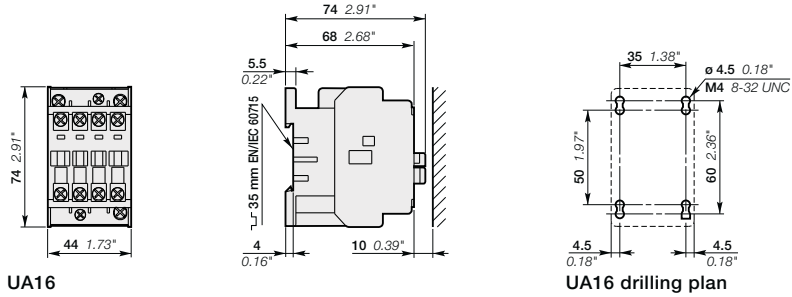

5

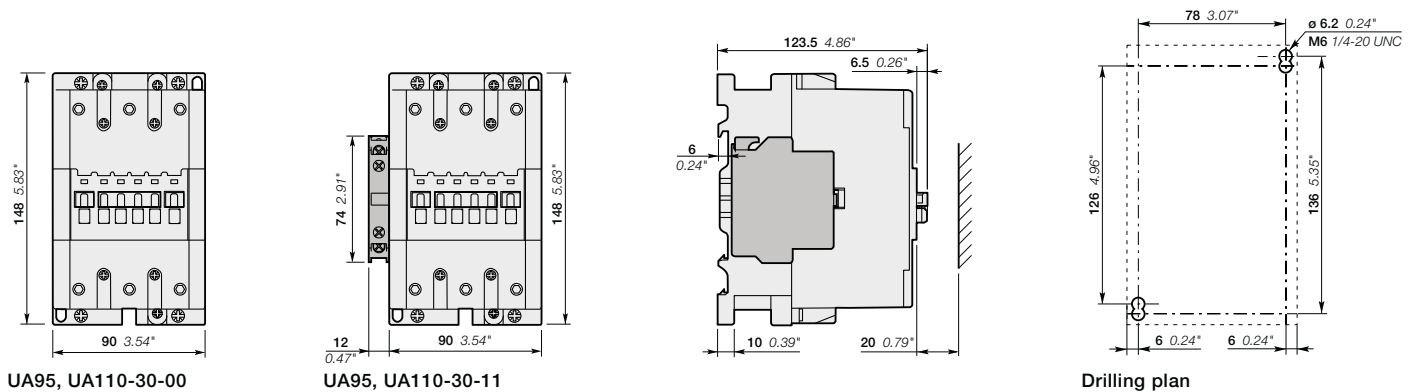
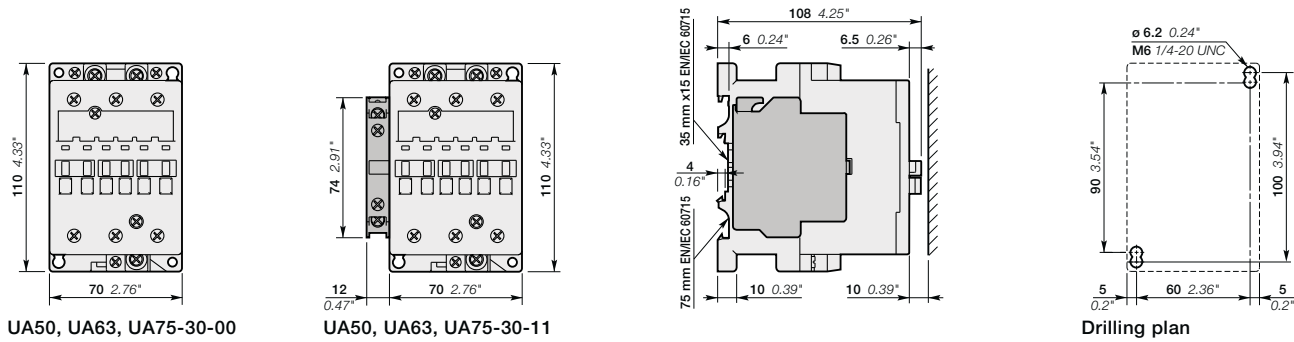
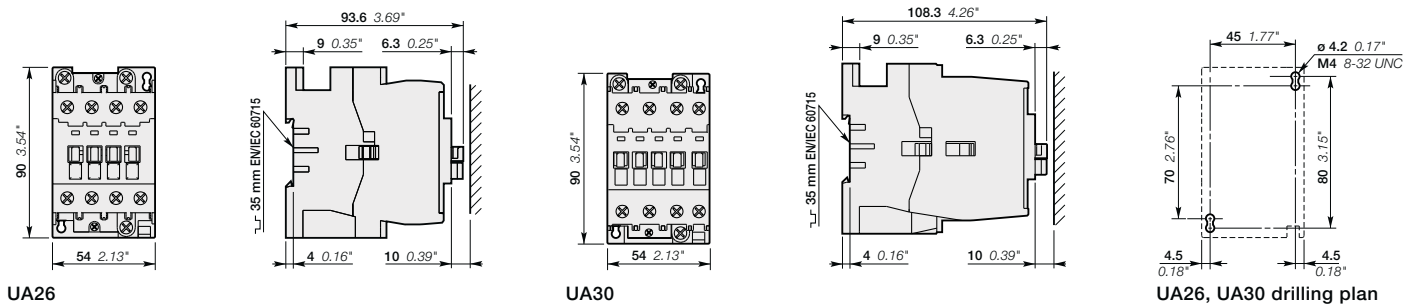

AF 3-pole contactors for capacitor switching

Single step - Peak current $\hat{I} \leq 30$ times the rms current

Description

The AF116 ... AF1650 3-pole contactors are suited for capacitor bank switching for the peak current and power values in the table below. The capacitors must be discharged (maximum residual voltage at terminals ≤ 50 V) before being re-energized when the contactors are making. In this conditions, electrical durability of contactors is equal to 100 000 operating cycles.

AF116 ... AF370 3-pole contactors

Contactor types	AF116	AF140	AF146	AF190	AF205	AF265	AF305	AF370		
AC-6b Utilization category										
For air temperature close to contactor										
Rated operational power AC-6b										
 Single-step capacitor bank scheme	$\theta \leq 40$ °C	230-240 V	40 kvar	45 kvar	50 kvar	60 kvar	75 kvar	85 kvar	100 kvar	110 kvar
		400-415 V	75 kvar	85 kvar	90 kvar	110 kvar	130 kvar	145 kvar	165 kvar	200 kvar
		440 V	75 kvar	90 kvar	93 kvar	115 kvar	135 kvar	155 kvar	180 kvar	200 kvar
		500-550 V	83 kvar	95 kvar	110 kvar	140 kvar	160 kvar	180 kvar	210 kvar	240 kvar
		690 V	80 kvar	95 kvar	110 kvar	135 kvar	170 kvar	200 kvar	240 kvar	280 kvar
		1000 V	-	-	100 kvar	140 kvar	150 kvar	155 kvar	160 kvar	170 kvar
	$\theta \leq 55$ °C	230-240 V	40 kvar	45 kvar	50 kvar	60 kvar	75 kvar	85 kvar	100 kvar	110 kvar
		400-415 V	70 kvar	85 kvar	90 kvar	110 kvar	130 kvar	145 kvar	165 kvar	200 kvar
		440 V	75 kvar	90 kvar	93 kvar	115 kvar	135 kvar	155 kvar	180 kvar	200 kvar
		500-550 V	83 kvar	95 kvar	110 kvar	135 kvar	160 kvar	180 kvar	210 kvar	240 kvar
		690 V	80 kvar	95 kvar	110 kvar	135 kvar	170 kvar	200 kvar	240 kvar	280 kvar
		1000 V	-	-	100 kvar	140 kvar	150 kvar	155 kvar	160 kvar	170 kvar
	$\theta \leq 70$ °C	230-240 V	35 kvar	40 kvar	42 kvar	45 kvar	57 kvar	70 kvar	85 kvar	100 kvar
		400-415 V	65 kvar	80 kvar	74 kvar	83 kvar	105 kvar	135 kvar	155 kvar	180 kvar
		440 V	65 kvar	85 kvar	80 kvar	85 kvar	110 kvar	140 kvar	163 kvar	180 kvar
		500-550 V	78 kvar	90 kvar	96 kvar	102 kvar	130 kvar	165 kvar	196 kvar	220 kvar
		690 V	75 kvar	90 kvar	110 kvar	135 kvar	160 kvar	200 kvar	240 kvar	260 kvar
		1000 V	-	-	95 kvar	120 kvar	130 kvar	140 kvar	150 kvar	160 kvar
Max. permissible peak current I	Ue ≤ 500 V	4 kA	4 kA	4 kA	5 kA	6.5 kA	8 kA	8 kA	8 kA	

5

AF400 ... AF1650 3-pole contactors

Contactor types	AF400	AF460	AF580	AF750	AF1350	AF1650		
AC-6b Utilization category								
For air temperature close to contactor								
Rated operational power AC-6b								
 Single-step capacitor bank scheme	$\theta \leq 40$ °C	230-240 V	120 kvar	140 kvar	170 kvar	220 kvar	250 kvar	300 kvar
		400-415 V	210 kvar	240 kvar	285 kvar	400 kvar	450 kvar	500 kvar
		440 V	220 kvar	260 kvar	300 kvar	410 kvar	500 kvar	550 kvar
		500-550 V	260 kvar	325 kvar	350 kvar	490 kvar	550 kvar	600 kvar
		690 V	300 kvar	325 kvar	440 kvar	600 kvar	650 kvar	800 kvar
		1000 V	250 kvar	300 kvar	350 kvar	450 kvar	-	-
	$\theta \leq 55$ °C	230-240 V	120 kvar	140 kvar	170 kvar	220 kvar	250 kvar	300 kvar
		400-415 V	210 kvar	240 kvar	285 kvar	400 kvar	450 kvar	500 kvar
		440 V	220 kvar	260 kvar	300 kvar	410 kvar	500 kvar	550 kvar
		500-550 V	260 kvar	325 kvar	350 kvar	480 kvar	550 kvar	600 kvar
		690 V	300 kvar	325 kvar	440 kvar	600 kvar	650 kvar	800 kvar
		1000 V	250 kvar	300 kvar	350 kvar	450 kvar	-	-
	$\theta \leq 70$ °C	230-240 V	105 kvar	120 kvar	160 kvar	190 kvar	230 kvar	280 kvar
		400-415 V	195 kvar	225 kvar	275 kvar	370 kvar	430 kvar	480 kvar
		440 V	200 kvar	230 kvar	290 kvar	380 kvar	470 kvar	520 kvar
		500-550 V	241 kvar	300 kvar	340 kvar	435 kvar	530 kvar	570 kvar
		690 V	300 kvar	325 kvar	440 kvar	600 kvar	630 kvar	750 kvar
		1000 V	220 kvar	270 kvar	300 kvar	400 kvar	-	-
Max. permissible peak current I	Ue ≤ 500 V	10 kA	10 kA	12 kA	12 kA	18 kA	20 kA	

Other contactor application data

Contactor selection

Control of three-phase slip-ring motors	5/298
Autotransformer starters	5/300
Three-phase transformer switching	5/301
Lighting circuit switching	5/303
Parallel connection of main poles	5/312
Temporary or intermittent duty	5/313

Influence of the length of conductors used in contactor

control circuit	5/314
-----------------------	-------

Voltage code table

.....	5/410
-------	-------

Control of three-phase slip-ring motors

Contactors selection

General

Three kinds of contactors are used to control three-phase slip-ring motors: the stator contactor, the acceleration contactor(s) and the rotor short-circuit contactor. Refer to the diagram opposite.

The selection tables below concern complete smooth starting, excluding specific cases, such as: intermittent operation, regenerative current, controlled slipping, etc. for which you need to consult our specialised departments.

The starting and breaking technical data for slip-ring motors are defined in standard IEC 60947-4-1 in the AC-2 utilization category.

The load factor is defined by the equation:

$$\text{L.F. (\%)} = \frac{\text{Operating cycle}}{\text{Cycle time (Operating cycle + Rest cycle)}} \times 100$$

Stator contactor

Closing of the starting current, conditioned by the value of the rotor resistances: it may reach 1.5 to 4 times rated motor operational current.

Breaking of the rated operational current, or of the starting current, with possible regenerative current.

The following table gives the permissible values of the I_e / AC-2 rated operational stator current, as a function of load factor.

Temperature of 60 °C for AF09 ... AF370 and 55 °C for AF400 ... AF1650 maximum near the contactor.

Maximum switching frequency and electrical durability in AC-2 category: see "Technical data".

Contactor types			AF09	AF12	AF16	AF26	AF30	AF38	AF40	AF52	AF65	AF80	AF96	
Load factor	15 %	I_e / AC-2 A	18	24	33	52	64	76	79	106	124	154	184	
	25 %	I_e / AC-2 A	15	20	31	44	54	65	68	90	111	136	163	
	40 %	I_e / AC-2 A	13	17	26	38	46	55	58	77	94	116	139	
	60 %	I_e / AC-2 A	11	14	22	31	38	46	48	64	78	96	115	
S7 acc. to IEC 60034-1: periodical continuous duty with electrical breaking			A	9	12	18	26	32	38	40	53	65	80	96

Acceleration contactors

The sizing of these contactors is based on the AC-1 rated operational current (see "Technical data") that we recall below for the maximum ambient temperature of 60 °C for AF09 to AF370 and 55 °C for AF400 to AF1650.

The table below lists the factors to be applied to the AC-1 current of the contactors in order to obtain the maximal permissible value of the rotor current after contactor closing for star connection. If delta connection is used, increase by 50 % this current. This table takes into account the number of cycles an hour (without inching) and the current flow time per cycle, in the contactor.

Number of cycles an hour	1	3	6	12	20	30	60	120
Current flow time per cycle	Factors applicable to I_e / AC-1							
5 s	5.2	4.9	4.7	4.3	4.0	3.7	3.4	2.8
10 s	3.8	3.6	3.4	3.1	3.0	2.8	2.6	2.2
20 s	2.8	2.7	2.6	2.5	2.4	2.2	2.0	1.6
30 s	2.4	2.3	2.2	2.1	2.1	1.9	1.7	-
40 s	2.2	2.1	2.0	1.9	1.9	1.7	1.5	-
60 s	1.9	1.8	1.8	1.7	1.7	1.5	-	-

Contactors	AF09	AF12	AF16	AF26	AF30	AF38	AF40	AF52	AF65	AF80	AF96
Rated operational current I_e / AC-1 for air temperature near the contactor ≤ 60 °C	A	25	28	30	40	42	60	80	90	100	105

Rotor short-circuit contactor

The duty of this contactor is characterized by small closing stresses. The decisive factor is the thermal stress. Delta connection of the contactor is considered (reduce currents by 35 % if star connection is used).

The following table gives the permissible values of the rated operational rotor current, as a function of load factor.

Temperature: 60 °C for AF09 to AF370 and 55 °C for AF400 to AF1650 maximum near the contactor.

Contactor types			AF09	AF12	AF16	AF26	AF30	AF38	AF40	AF52	AF65	AF80	AF96	
Load factor	15 %	I_e	A	63	71	76	102	107	107	152	203	228	254	266
	25 %	I_e	A	57	64	69	92	96	96	137	183	206	229	241
	40 %	I_e	A	49	55	59	78	82	82	117	157	176	196	206
	60 %	I_e	A	43	48	51	68	72	72	103	137	154	171	180
S7 acc. to IEC 60034-1: periodical continuous duty with electrical breaking			A	36	41	44	58	61	61	87	116	131	145	152
Rated operational rotor voltage:														
– Maximum values for starting and breaking			V	1380 (1600 in star connection)									2000 (2300 in star connection)	
– Maximum values for starting and electrical braking			V	690 (730 in star connection)									690 (730 in star connection)	

Control of three-phase slip-ring motors

Contactors selection

Example of a three-stroke starter

- The first stroke corresponds to energization of the motor by the stator contactor: all the resistances are operational in the rotor circuit
- At the second stroke, the acceleration contactor short-circuits the first resistance stack
- At the third stroke, the rotor short-circuit contactor is activated by eliminating the last resistance stack, thus completing the starting period.

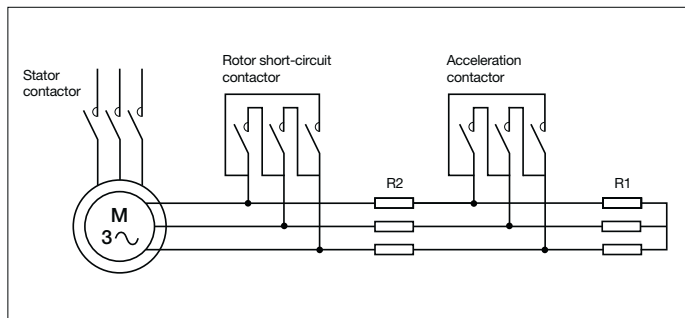

Contactor types			AF116	AF140	AF190	AF205	AF265	AF305	AF370	AF400	AF460	AF580	AF750	AF1350	AF1650	
Load factor	15 %	le / AC-2	A	220	335	360	425	530	625	750	850	950	1150	1500	1720	2100
	25 %	le / AC-2	A	185	270	300	350	440	515	620	680	780	975	1250	1430	1750
	40 %	le / AC-2	A	150	215	250	300	370	430	515	580	650	800	1050	1200	1470
	60 %	le / AC-2	A	135	180	220	255	315	370	430	480	550	700	900	1030	1250
S7 acc. to IEC 60034-1: periodical continuous duty with electrical breaking			A	116	140	190	210	265	305	370	400	460	580	750	860	1050

Contactors		AF116	AF140	AF190	AF205	AF265	AF305	AF370	AF400	AF460	AF580	AF750	AF1350	AF1650
Rated operational current le / AC-1 for air temperature near the contactor ≤ 60 °C (AF116-AF370) ≤ 55 °C (AF400-AF1650)	A	145	175	250	300	350	400	500	500	600	700	800	1150	1450

Contactor types			AF116	AF140	AF190	AF205	AF265	AF305	AF370	AF400	AF460	AF580	AF750	AF1350	AF1650	
Load factor	15 %	le / AC-2	A	330	540	580	750	830	950	1050	1200	1400	1650	1900	2400	2800
	25 %	le / AC-2	A	300	490	530	650	725	830	915	1050	1250	1450	1650	2100	2500
	40 %	le / AC-2	A	260	425	460	575	630	720	800	950	1100	1300	1450	1850	2200
	60 %	le / AC-2	A	230	375	400	500	575	650	700	810	975	1150	1300	1650	1950
S7 acc. to IEC 60034-1: periodical continuous duty with electrical breaking			A	200	300	350	380	480	550	640	700	840	980	1150	1500	1800
Rated operational rotor voltage:																
- Maximum values for starting and breaking	V	2200	(2600 in star connection)			3000			(3600 in star connection)							
- Maximum values for starting and electrical braking	V	690	(730 in star connection)													

Autotransformer starters

Contactor selection

General

An autotransformer starter allows to start a squirrel cage motor with a reduced starting current due to the reduced voltage within the accelerating duration.

Unlike the star-delta wiring, this autotransformer starting method needs three wires and three terminals on the motor. At the starting period, the motor is wired to the autotransformer taps: the star contactor "KM3" and the autotransformer contactor "KM2" are closed, the motor is under reduced voltage. Consequently, the torque is reduced as the square of the applied voltage. The autotransformers are generally equipped of three taps at each phase in order to adapt the starting parameters to the field requirements.

When the motor reaches 80...95 % of its nominal speed, the star contactor opens. Then, the line contactor "KM1" is making and the autotransformer contactor is opening. This starting process is done without any network interruption.

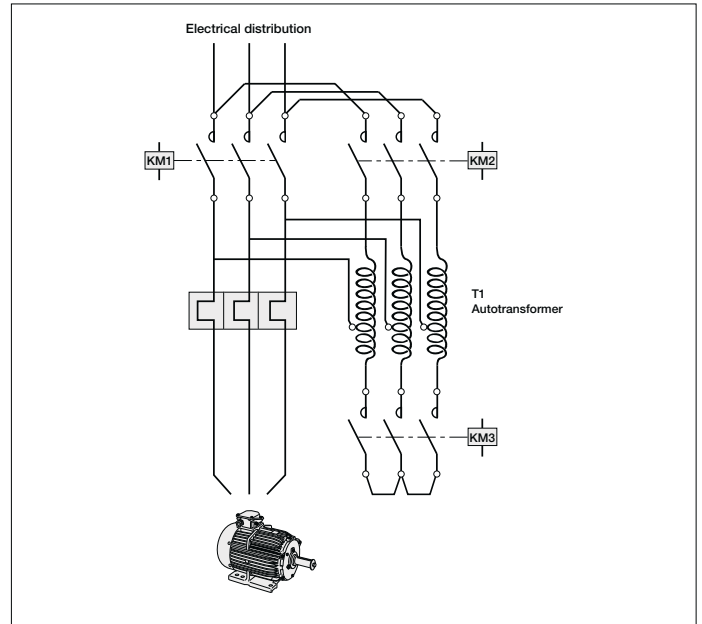

5

Selection Table (I_d starting current / I_n nominal current < 8 - Acceleration time ≤ 20s - 30 cycles / h max.)

kW motor ratings 50/60 Hz					Contactors					
220/240 V	380/400 V	415 V	440 V	690 V	KM1 line	KM2 autotransformer taps:				KM3 star
						90 %	80 %	70 %	60 %	
4	7.5	7.5	7.5	9	AF16	AF16	AF12	AF09	AF09	AF09
6.5	11	11	11	15	AF26	AF26	AF16	AF16	AF09	AF16
11	18.5	18.5	18.5	22	AF38	AF30	AF26	AF26	AF16	AF26
15	22	30	30	30	AF52	AF52	AF38	AF30	AF26	AF30
18.5	30	37	37	37	AF65	AF52	AF40	AF30	AF26	AF38
22	37	45	45	45	AF80	AF65	AF52	AF40	AF30	AF40
25	45	55	55	55	AF96	AF80	AF65	AF52	AF38	AF52
30	55	55	75	55	AF116	AF116	AF80	AF65	AF52	AF65
37	75	75	90	75	AF140	AF140	AF96	AF80	AF65	AF65
45	75	75	90	90	AF146	AF140	AF96	AF80	AF65	AF65
55	90	90	110	132	AF190	AF146	AF116	AF96	AF65	AF80
55	110	110	132	160	AF205	AF190	AF140	AF116	AF80	AF96
75	132	132	160	200	AF265	AF265	AF190	AF140	AF96	AF116
90	160	160	160	250	AF305	AF265	AF205	AF190	AF116	AF140
110	200	200	200	315	AF370	AF370	AF265	AF190	AF140	AF190
132	250	250	250	355	AF460	AF400	AF305	AF265	AF190	AF205
160	315	355	355	500	AF580	AF580	AF400	AF305	AF205	AF305
220	400	425	450	600	AF750	AF750	AF580	AF400	AF305	AF400
257	475	500	560	900	AF1350	AF750	AF580	AF460	AF400	AF460
315	560	600	670	1000	AF1650	AF1350	AF750	AF580	AF460	AF580

Three-phase transformer switching

Contactors selection

AC-6a Utilization category according to IEC 60947-4-1

General

Switching the primary of 3-phase transformers, on energization of the transformer, is characterized by high current peaks due to the magnetization phenomena.

Selection Table

The tables below show the operational ratings for:

- current peaks up to 20 to 30 times the transformer nominal current
- maximum switching frequency of 60 operating cycles per hour
- air ambient temperature ≤ 40 °C.

AC / DC operated contactors		AF09	AF12	AF16	AF26	AF30	AF38	AF40	AF52	AF65	AF80	AF96
Operational power at Ue: 50/60 Hz - according to AC-6a												
220 / 240 V	kVA	4	5	6	10	13	14	15	19	21	23	25
380 / 400 V	kVA	7	8	10	17	22	25	26	33	36	39	44
415 / 440 V	kVA	8	9	11	18	24	27	28.5	36	40	43	48
500 V	kVA	9	11	13	22	28	32	34.5	43	48	52	57
660 / 690 V	kVA	12.5	14	18	29	37	43	45.5	57	64	68	75
Max. permissible I _{peak}	A	350	400	500	800	1000	1200	1250	1550	1750	1900	2100

AC / DC operated contactors		AF116	AF140	AF190	AF205	AF265	AF370	AF400	AF460	AF580	AF750	AF1250	AF1350	AF1650
Operational power at Ue: 50/60 Hz - according to AC-6a														
220 / 240 V	kVA	26	30	42	45	55	63	76	95	100	110	130	160	190
380 / 400 V	kVA	46	52	73	75	94	108	132	165	170	190	240	275	350
415 / 440 V	kVA	50	57	80	80	103	118	144	180	190	210	270	325	390
500 V	kVA	60	68	96	100	124	143	173	220	230	250	320	–	–
660 / 690 V	kVA	80	90	127	130	164	188	228	290	300	310	410	–	–
Max. permissible I _{peak}	A	2100	2400	3300	3500	4300	4900	6000	7700	8400	9300	12000	–	–

Lighting circuit switching

Contactor selection

General

Contactor selection criteria for control of lighting circuits are as follows:

- type, power rating and number of lamps
- connection mode
- current values on closing and in steady state
- power factor
- presence or not of correction capacitors.

Lighting circuits

In a given circuit, the number and power rating of lamps are defined and cannot result in overload. Only short-circuit protection has to be provided. gG fuses or modular circuit-breakers will be chosen for this purpose.

The lamps have very specific technical data, according to their construction type.

- Incandescent lamps have a very high current on closing: more than 15 times nominal current. They do not introduce a large phase displacement between current and voltage
- Fluorescent tubes are equipped with a ballast whose purpose is two-fold: contribute to ignition and limit current to nominal value once steady state is reached. This ballast is a reactor that considerably lowers the power factor. It may or may not be compensated.

Individual compensation
(parallel compensation)

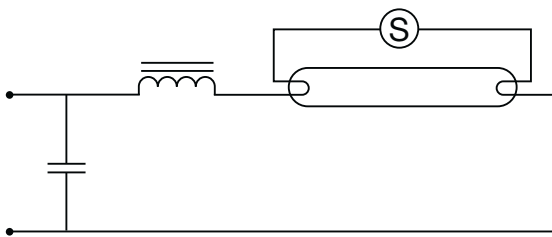

Serial compensation in dual mounting

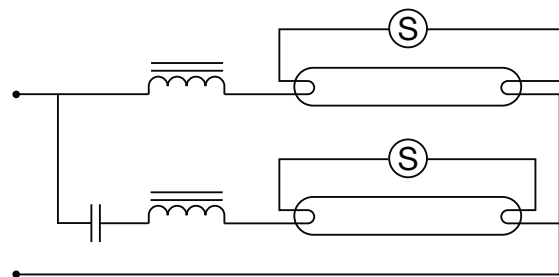

Selection of contactors

The following tables indicate, for each contactor type, the maximum permissible number of lamps per phase. Air temperature, near the contactor, must be limited to 60 °C. Numbers are given for a 230 V voltage distributed between phase and neutral: single-phase (phase + neutral) or three-phase (3 phases + neutral) distribution, lamps are wired in star connection. In the case of a three-phase supply without neutral, 230 V phase-to-phase, the permissible number of lamps per phase will be that given in the tables multiplied by 0.58.

Example:

120 x 100 W / 230 V incandescent lamps - 400 V three-phase network with distributed neutral.

Calculate the number of lamps per phase: $120 : 3 = 40$. On the 100 W line of the incandescent lamp table, contactor AF09 is limited to 38 lamps per phase, you must thus select contactor AF12 which accepts up to 43 lamps per phase.

Lighting circuit switching

Contactors selection AF09 ... AF146 3-pole contactors

Selection table

3-pole AC / DC operated contactors			AF09	AF12	AF16	AF26	AF30	AF38	AF40	AF52	AF65	AF80	AF96	AF116	AF140	AF146
Lamp characteristics			Maximum permissible number of lamps per phase													
W	A	μF														

Incandescent and halogen lamps

according to AC-5b

Voltage: 220/240 V AC

60	0.27	-	64	72	77	103	129	148	177	207	233	259	277	430	519	541
100	0.45	-	38	43	46	62	77	89	106	124	140	155	166	258	311	324
200	0.91	-	19	21	23	30	38	44	52	61	69	77	82	127	154	160
300	1.37	-	12	14	15	20	25	29	35	41	46	51	54	85	102	107
500	2.28	-	7	8	9	12	15	17	21	24	27	30	33	51	61	64
1000	4.55	-	3	4	4	6	7	8	10	12	13	15	16	25	31	32

5

Fluorescent lamps without compensation - Fluorescent lamps with electronic starter

according to AC-5a

Voltage: 220/240 V AC

20	0.38	-	46	51	55	73	84	92	126	147	157	184	210	305	368	384
40	0.45	-	38	43	46	62	71	77	106	124	133	155	177	258	311	324
65	0.70	-	25	27	30	40	45	50	68	80	85	100	114	166	200	209
80	0.80	-	21	24	26	35	40	43	60	70	75	87	100	145	175	183
100	1.15	-	15	16	18	24	27	30	41	48	52	60	69	101	122	127
110	1.20	-	14	16	17	23	26	29	40	46	50	58	66	97	117	122

Fluorescent lamps with parallel compensation

according to AC-5a

Voltage: 220/240 V AC

20	0.18	5	53	53	53	155	168	176	266	309	325	388	444	644	778	811
40	0.26	5	53	53	53	107	123	134	184	215	230	269	307	446	538	562
65	0.42	7	37	37	37	66	76	83	114	133	142	166	190	276	333	348
80	0.52	7	33	37	37	53	61	67	92	107	115	134	153	223	269	281
100	0.65	16	16	16	16	43	49	53	73	86	92	107	123	178	215	225
110	0.70	18	14	14	14	40	45	49	68	80	85	100	114	166	200	209

Fluorescent lamps in dual mounting

according to AC-5a

Voltage: 220/240 V AC

2 x 20	2 x 0.14	-	62	69	75	100	114	125	171	200	214	250	285	414	500	521
2 x 40	2 x 0.25	-	35	39	42	56	64	70	96	112	120	140	160	232	280	292
2 x 65	2 x 0.40	-	21	24	26	35	40	43	60	70	75	87	100	145	175	183
2 x 80	2 x 0.48	-	18	20	21	29	33	36	50	58	62	72	83	121	146	152
2 x 100	2 x 0.60	-	14	16	17	23	26	29	40	46	50	58	66	97	117	122
2 x 110	2 x 0.65	-	13	15	16	21	24	26	36	43	46	53	61	89	108	112

Compact fluorescent lamps

according to AC-5a

Voltage: 220/240 V AC

5	0.045	-	388	433	466	622	711	777	1066	1244	1333	1555	1777	2578	3111	3244
7	0.075	-	233	260	280	373	426	466	640	746	800	933	1066	1547	1867	1947
11	0.105	-	166	185	200	266	304	333	457	533	571	666	761	1105	1333	1390
15	0.135	-	129	144	155	207	237	259	355	414	444	518	592	859	1037	1081
20	0.160	-	109	121	131	175	200	218	300	350	375	437	500	725	875	913
23	0.180	-	97	108	116	155	177	194	266	311	333	388	444	644	778	811

Lighting circuit switching

Contactor selection AF190 ... AF2650 3-pole contactors

Selection table

3-pole AC / DC operated contactors			AF190	AF205	AF265	AF305	AF370	AF400	AF460	AF580	AF750	AF1250	AF1350	AF1650	AF2050	AF2650
Lamp characteristics			Maximum permissible number of lamps per phase													
W	A	μF														

Incandescent and halogen lamps

according to AC-5b

Voltage: 220/240 V AC

60	0.27	-	704	759	981	1130	1370	1481	1704	2148	2778	3009	3250	3972	4935	6380
100	0.45	-	422	456	589	678	822	889	1022	1289	1667	1806	1950	2383	2961	3828
200	0.91	-	209	225	291	335	407	440	505	637	824	893	964	1179	1464	1893
300	1.37	-	139	150	193	223	270	292	336	423	547	593	641	783	973	1257
500	2.28	-	83	90	116	134	162	175	202	254	329	356	385	470	584	755
1000	4.55	-	42	45	58	67	81	88	101	127	165	179	193	236	293	379

Fluorescent lamps without compensation - Fluorescent lamps with electronic starter

according to AC-5a

Voltage: 220/240 V AC

20	0.38	-	500	539	697	803	974	1053	1211	1526	1974	2138	2309	2822	3507	4533
40	0.45	-	422	456	589	678	822	889	1022	1289	1667	1806	1950	2383	2961	3828
65	0.70	-	271	293	379	436	529	571	657	829	1071	1161	1254	1532	1904	2461
80	0.80	-	238	256	331	381	463	500	575	725	938	1016	1097	1341	1666	2153
100	1.15	-	165	178	230	265	322	348	400	504	652	707	763	933	1159	1498
110	1.20	-	158	171	221	254	308	333	383	483	625	677	731	894	1110	1435

Fluorescent lamps with parallel compensation

according to AC-5a

Voltage: 220/240 V AC

20	0.18	5	1056	1139	1472	1694	2056	2222	2556	3222	4167	4514	4875	5958	7403	9569
40	0.26	5	731	788	1019	1173	1423	1538	1769	2231	2885	3125	3375	4125	5125	6625
65	0.42	7	452	488	631	726	881	952	1095	1381	1786	1935	2089	2554	3173	4101
80	0.52	7	365	394	510	587	712	769	885	1115	1442	1563	1688	2063	2563	3313
100	0.65	16	292	315	408	469	569	615	708	892	1154	1250	1350	1650	2050	2650
110	0.70	18	271	293	379	436	529	571	657	829	1071	1161	1254	1532	1904	2461

Fluorescent lamps in dual mounting

according to AC-5a

Voltage: 220/240 V AC

2 x 20	2 x 0.14	-	679	732	946	1089	1321	1429	1643	2071	2679	2902	3134	3830	4759	6152
2 x 40	2 x 0.25	-	380	410	530	610	740	800	920	1160	1500	1625	1755	2145	2665	3445
2 x 65	2 x 0.40	-	238	256	331	381	463	500	575	725	938	1016	1097	1341	1666	2153
2 x 80	2 x 0.48	-	198	214	276	318	385	417	479	604	781	846	914	1117	1388	1794
2 x 100	2 x 0.60	-	158	171	221	254	308	333	383	483	625	677	731	894	1110	1435
2 x 110	2 x 0.65	-	146	158	204	235	285	308	354	446	577	625	675	825	1025	1325

Compact fluorescent lamps

according to AC-5a

Voltage: 220/240 V AC

5	0.045	-	4222	4556	5889	6778	8222	8889	10222	12889	16667	18056	19500	23833	29611	38278
7	0.075	-	2533	2733	3533	4067	4933	5333	6133	7733	10000	10833	11700	14300	17767	22967
11	0.105	-	1810	1952	2524	2905	3524	3810	4381	5524	7143	7738	8357	10214	12690	16405
15	0.135	-	1407	1519	1963	2259	2741	2963	3407	4296	5556	6019	6500	7944	9870	12759
20	0.160	-	1188	1281	1656	1906	2313	2500	2875	3625	4688	5078	5484	6703	8328	10766
23	0.180	-	1056	1139	1472	1694	2056	2222	2556	3222	4167	4514	4875	5958	7403	9569

Lighting circuit switching

Contactor selection AF09 ... AF146 3-pole contactors

Selection table

3-pole AC / DC operated contactors			AF09	AF12	AF16	AF26	AF30	AF38	AF40	AF52	AF65	AF80	AF96	AF116	AF140	AF146
Lamp characteristics			Maximum permissible number of lamps per phase													
W	A	µF														

Low pressure sodium vapour lamps without compensation

Voltage: 220/240 V AC

35	1.4	-	9	10	12	15	15	16	23	31	35	39	42	70	85	89
55	1.4	-	9	10	12	15	15	16	23	31	35	39	42	70	85	89
90	2.1	-	6	7	8	10	10	10	15	20	23	26	28	47	57	59
135	3.1	-	4	4	5	6	7	7	10	14	15	17	19	32	38	40
180	3.1	-	4	4	5	6	7	7	10	14	15	17	19	32	38	40

Low pressure sodium vapour lamps with parallel compensation

Voltage: 220/240 V AC

35	0.6	20	12	12	12	35	36	38	55	73	81	91	100	164	198	207
55	0.6	20	12	12	12	35	36	38	55	73	81	91	100	164	198	207
90	0.9	25	10	10	10	23	24	25	36	48	55	61	66	110	132	138
135	0.9	45	5	5	5	18	18	19	34	34	36	57	59	110	132	138
180	0.9	45	5	5	5	18	18	19	34	34	36	57	59	110	132	138

High pressure sodium vapour lamps without compensation

Voltage: 220/240 V AC

150	1.8	-	7	8	9	11	12	12	18	24	27	30	33	45	54	57
250	3.0	-	4	5	5	7	7	7	11	14	16	18	20	27	33	34
400	4.4	-	3	3	3	4	5	5	7	10	11	12	13	18	22	23
600	6.2	-	2	2	2	3	3	3	5	7	7	8	9	13	16	16
1000	10.3	-	1	1	1	2	2	2	3	4	4	5	5	8	10	10

High pressure sodium vapour lamps with parallel compensation

Voltage: 220/240 V AC

150	1.0	20	12	12	12	21	22	23	33	43	49	55	60	93	112	117
250	1.5	36	7	7	7	14	14	15	22	29	33	36	40	62	75	78
400	2.5	48	5	5	5	8	8	9	13	17	19	22	24	37	45	47
600	3.3	65	3	3	3	6	6	6	10	13	15	16	18	28	34	35
1000	6.2	100	2	2	2	3	3	3	5	7	7	8	9	15	18	19

High pressure mercury vapour lamps without compensation

Voltage: 220/240 V AC

50	0.60	-	22	25	28	35	36	38	55	73	82	91	100	152	190	214
80	0.80	-	16	18	21	26	27	28	41	55	61	68	75	114	143	160
125	1.15	-	11	13	14	18	19	20	28	38	43	47	52	79	99	112
250	2.15	-	6	6	7	9	10	10	15	20	23	25	27	42	53	60
400	3.25	-	4	4	5	6	6	7	10	13	15	16	18	28	35	39
700	5.40	-	2	2	3	3	4	4	6	8	9	10	11	17	21	24
1000	7.50	-	1	2	2	2	2	3	4	5	6	7	8	12	15	17

Voltage: 380/415 V AC

2000	8.00	-	1	1	2	2	2	2	4	5	6	6	7	11	14	16
------	------	---	---	---	---	---	---	---	---	---	---	---	---	----	----	----

High pressure mercury vapour lamps with compensation

Voltage: 220/240 V AC

50	0.28	7	36	36	36	75	78	82	117	157	176	196	214	326	407	458
80	0.43	8	31	31	31	48	51	53	76	102	115	127	139	212	265	298
125	0.66	10	20	22	25	31	33	34	50	66	75	83	90	138	173	194
250	1.28	18	10	11	13	16	17	17	25	34	38	42	46	71	89	100
400	2.05	25	6	7	8	10	10	11	16	21	24	26	29	44	56	63
700	3.55	40	3	4	4	5	6	6	9	12	13	15	16	26	32	36
1000	4.83	60	2	3	3	4	4	4	6	9	10	11	12	19	24	27

Voltage: 380/415 V AC

2000	5.45	35	2	2	3	3	4	4	6	8	9	10	11	17	21	24
------	------	----	---	---	---	---	---	---	---	---	---	----	----	----	----	----

Lighting circuit switching

Contactors selection AF190 ... AF2650 3-pole contactors

Selection table

3-pole AC / DC operated contactors			AF190	AF205	AF265	AF305	AF370	AF400	AF460	AF580	AF750	AF1250	AF1350	AF1650	AF2050	AF2650
Lamp characteristics			Maximum permissible number of lamps per phase													
W	A	µF														

Low pressure sodium vapour lamps without compensation

Voltage: 220/240 V AC

35	1.4	-	115	124	161	185	225	243	279	352	455	493	533	651	809	1046
55	1.4	-	115	124	161	185	225	243	279	352	455	493	533	651	809	1046
90	2.1	-	77	83	107	123	150	162	186	235	304	329	355	434	539	697
135	3.1	-	52	56	73	84	101	110	126	159	206	223	241	294	365	472
180	3.1	-	52	56	73	84	101	110	126	159	206	223	241	294	365	472

Low pressure sodium vapour lamps with parallel compensation

Voltage: 220/240 V AC

35	0.6	20	269	290	375	432	524	567	652	822	1063	1151	1243	1519	1888	2440
55	0.6	20	269	290	375	432	524	567	652	822	1063	1151	1243	1519	1888	2440
90	0.9	25	179	194	250	288	349	378	434	548	708	767	829	1013	1258	1627
135	0.9	45	179	194	250	288	349	378	434	548	708	767	829	1013	1258	1627
180	0.9	45	179	194	250	288	349	378	434	548	708	767	829	1013	1258	1627

High pressure sodium vapour lamps without compensation

Voltage: 220/240 V AC

150	1.8	-	74	80	103	119	144	156	179	226	292	313	338	413	513	663
250	3.0	-	44	48	62	71	86	93	107	135	175	188	203	248	308	398
400	4.4	-	30	33	42	49	59	64	73	92	119	128	138	169	210	271
600	6.2	-	21	23	30	34	42	45	52	65	85	91	98	120	149	192
1000	10.3	-	13	14	18	21	25	27	31	39	51	55	59	72	90	116

High pressure sodium vapour lamps with parallel compensation

Voltage: 220/240 V AC

150	1.0	20	152	164	212	244	296	320	368	464	600	625	675	825	1025	1325
250	1.5	36	101	109	141	163	197	213	245	309	400	417	450	550	683	883
400	2.5	48	61	66	85	98	118	128	147	186	240	250	270	330	410	530
600	3.3	65	46	50	64	74	90	97	112	141	182	189	205	250	311	402
1000	6.2	100	25	26	34	39	48	52	59	75	97	101	109	133	165	214

High pressure mercury vapour lamps without compensation

Voltage: 220/240 V AC

50	0.60	-	261	333	380	475	570	570	665	760	998	1188	1283	1568	1948	2518
80	0.80	-	196	249	285	356	428	428	499	570	748	891	962	1176	1461	1888
125	1.15	-	136	173	198	248	297	297	347	397	520	620	669	818	1016	1313
250	2.15	-	73	93	106	133	159	159	186	212	278	331	358	437	543	703
400	3.25	-	48	61	70	88	105	105	123	140	184	219	237	289	360	465
700	5.40	-	29	37	42	53	63	63	74	84	111	132	143	174	216	280
1000	7.50	-	21	27	30	38	46	46	53	61	80	95	103	125	156	201

Voltage: 380/415 V AC

2000	8.00	-	20	25	29	36	43	43	50	57	75	89	96	118	146	189
------	------	---	----	----	----	----	----	----	----	----	----	----	----	-----	-----	-----

High pressure mercury vapour lamps with compensation

Voltage: 220/240 V AC

50	0.28	7	560	713	814	1018	1221	1221	1425	1629	2138	2545	2748	3359	4173	5395
80	0.43	8	365	464	530	663	795	795	928	1060	1392	1657	1790	2187	2717	3513
125	0.66	10	238	302	345	432	518	518	605	691	907	1080	1166	1425	1770	2289
250	1.28	18	122	156	178	223	267	267	312	356	468	557	601	735	913	1180
400	2.05	25	76	97	111	139	167	167	195	222	292	348	375	459	570	737
700	3.55	40	44	56	64	80	96	96	112	128	169	201	217	265	329	425
1000	4.83	60	32	41	47	59	71	71	83	94	124	148	159	195	242	313

Voltage: 380/415 V AC

2000	5.45	35	29	37	42	52	63	63	73	84	110	131	141	173	214	277
------	------	----	----	----	----	----	----	----	----	----	-----	-----	-----	-----	-----	-----

Lighting circuit switching

Contactor selection AF09 ... AF146 3-pole contactors

Selection table

3-pole AC / DC operated contactors			AF09	AF12	AF16	AF26	AF30	AF38	AF40	AF52	AF65	AF80	AF96	AF116	AF140	AF146
Lamp characteristics			Maximum permissible number of lamps per phase													
W	A	μF														

Metal halide vapour lamps without compensation

Voltage: 220/240 V AC

250	3	-	4	5	5	7	7	7	11	14	16	18	20	27	33	38
400	4	-	3	3	4	5	5	5	8	11	12	13	15	20	25	28
1000	9.5	-	1	1	1	2	2	2	3	4	5	5	6	8	11	12
2000	16.5	-	0	0	1	1	1	1	2	2	3	3	3	5	6	7

Voltage: 380/415 V AC

2000	10.5	-	1	1	1	2	2	2	3	4	4	5	5	8	10	11
------	------	---	---	---	---	---	---	---	---	---	---	---	---	---	----	----

5 Metal halide vapour lamps with compensation

Voltage: 220/240 V AC

250	1.32	33	7	7	7	15	16	17	25	33	37	41	45	69	86	97
400	2.22	45	5	5	5	9	9	10	14	19	22	24	27	41	51	58
1000	5.14	85	2	2	3	4	4	4	6	8	9	10	11	18	22	25
2000	11.5	148	1	1	1	1	1	2	2	3	4	4	5	8	10	11

Voltage: 380/415 V AC

2000	6.10	60	2	2	2	3	3	3	5	7	8	9	9	15	19	21
------	------	----	---	---	---	---	---	---	---	---	---	---	---	----	----	----

Lighting circuit switching

Contactor selection AF190 ... AF2650 3-pole contactors

Selection table

3-pole AC / DC operated contactors			AF190	AF205	AF265	AF305	AF370	AF400	AF460	AF580	AF750	AF1250	AF1350	AF1650	AF2050	AF2650
Lamp characteristics			Maximum permissible number of lamps per phase													
W	A	μF														

Metal halide vapour lamps without compensation

Voltage: 220/240 V AC

250	3	-	46	58	67	83	100	100	117	133	175	208	225	275	342	442
400	4	-	34	44	50	63	75	75	88	100	131	156	169	206	256	331
1000	9.5	-	14	18	21	26	32	32	37	42	55	66	71	87	108	139
2000	16.5	-	8	11	12	15	18	18	21	24	32	38	41	50	62	80

Voltage: 380/415 V AC

2000	10.5	-	13	17	19	24	29	29	33	38	50	60	64	79	98	126
------	------	---	----	----	----	----	----	----	----	----	----	----	----	----	----	-----

Metal halide vapour lamps with compensation

Voltage: 220/240 V AC

250	1.32	33	119	151	173	216	259	259	302	345	453	540	583	713	885	1144
400	2.22	45	71	90	103	128	154	154	180	205	270	321	347	424	526	680
1000	5.14	85	30	39	44	55	67	67	78	89	116	139	150	183	227	294
2000	11.5	148	14	17	20	25	30	30	35	40	52	62	67	82	102	131

Voltage: 380/415 V AC

2000	6.10	60	26	33	37	47	56	56	65	75	98	117	126	154	192	248
------	------	----	----	----	----	----	----	----	----	----	----	-----	-----	-----	-----	-----

Lighting circuit switching

Contactor selection AF09 ... AF370 4-pole contactors

Selection table

4-pole AC / DC operated contactors			AF09	AF16	AF26	AF38	AF40	AF52	AF80	AF116	AF140	AF190	AF205	AF265	AF305	AF370
Lamp characteristics			Maximum permissible number of lamps per phase													
W	A	µF														

Incandescent and halogen lamps

according to AC-5b

Voltage: 220/240 V AC

60	0.27	-	64	77	103	114	177	207	259	430	519	704	759	981	1130	1370
100	0.45	-	38	46	62	68	106	124	155	258	311	422	456	589	678	822
200	0.91	-	19	23	30	34	52	61	77	127	154	209	225	291	335	407
300	1.37	-	12	15	20	22	35	41	51	85	102	139	150	193	223	270
500	2.28	-	7	9	12	13	21	24	30	51	61	83	90	116	134	162
1000	4.55	-	3	4	6	6	10	12	15	25	31	42	45	58	67	81

Fluorescent lamps without compensation - Fluorescent lamps with electronic starter

according to AC-5a

Voltage: 220/240 V AC

20	0.38	-	46	55	73	81	126	147	184	305	368	500	539	697	803	974
40	0.45	-	38	46	62	68	106	124	155	258	311	422	456	589	678	822
65	0.70	-	25	30	40	44	68	80	100	166	200	271	293	379	436	529
80	0.80	-	21	26	35	38	60	70	87	145	175	238	256	331	381	463
100	1.15	-	15	18	24	26	41	48	60	101	122	165	178	230	265	322
110	1.20	-	14	17	23	25	40	46	58	97	117	158	171	221	254	308

Fluorescent lamps with parallel compensation

according to AC-5a

Voltage: 220/240 V AC

20	0.18	5	53	53	110	110	266	309	309	644	778	1056	1139	1472	1694	2056
40	0.26	5	53	53	107	110	184	215	269	446	538	731	788	1019	1173	1423
65	0.42	7	37	37	66	73	114	133	166	276	333	452	488	631	726	881
80	0.52	7	33	37	53	59	92	107	134	223	269	365	394	510	587	712
100	0.65	16	16	16	34	34	73	86	96	178	215	292	315	408	469	569
110	0.70	18	14	14	30	30	68	80	86	166	200	271	293	379	436	529

Fluorescent lamps in dual mounting

according to AC-5a

Voltage: 220/240 V AC

2 x 20	2 x 0.14	-	62	75	100	110	171	200	250	414	500	679	732	946	1089	1321
2 x 40	2 x 0.25	-	35	42	56	62	96	112	140	232	280	380	410	530	610	740
2 x 65	2 x 0.40	-	21	26	35	38	60	70	87	145	175	238	256	331	381	463
2 x 80	2 x 0.48	-	18	21	29	32	50	58	72	121	146	198	214	276	318	385
2 x 100	2 x 0.60	-	14	17	23	25	40	46	58	97	117	158	171	221	254	308
2 x 110	2 x 0.65	-	13	16	21	23	36	43	53	89	108	146	158	204	235	285

Compact fluorescent lamps

according to AC-5a

Voltage: 220/240 V AC

5	0.045	-	388	466	622	688	1066	1244	1555	2578	3111	4222	4556	5889	6778	8222
7	0.075	-	233	280	373	413	640	746	933	1547	1867	2533	2733	3533	4067	4933
11	0.105	-	166	200	266	295	457	533	666	1105	1333	1810	1952	2524	2905	3524
15	0.135	-	129	155	207	229	355	414	518	859	1037	1407	1519	1963	2259	2741
20	0.160	-	109	131	175	193	300	350	437	725	875	1188	1281	1656	1906	2313
23	0.180	-	97	116	155	172	266	311	388	644	778	1056	1139	1472	1694	2056

Low pressure sodium vapour lamps without compensation

Voltage: 220/240 V AC

35	1.4	-	9	12	15	16	23	31	39	70	85	115	124	161	185	225
55	1.4	-	9	12	15	16	23	31	39	70	85	115	124	161	185	225
90	2.1	-	6	8	10	10	15	20	26	47	57	77	83	107	123	150
135	3.1	-	4	5	6	7	10	14	17	32	38	52	56	73	84	101
180	3.1	-	4	5	6	7	10	14	17	32	38	52	56	73	84	101

Low pressure sodium vapour lamps with parallel compensation

Voltage: 220/240 V AC

35	0.6	20	12	12	27	27	55	73	77	164	198	269	290	375	432	524
55	0.6	20	12	12	27	27	55	73	77	164	198	269	290	375	432	524
90	0.9	25	10	10	22	22	36	48	61	110	132	179	194	250	288	349
135	0.9	45	5	5	12	12	34	34	34	110	132	179	194	250	288	349
180	0.9	45	5	5	12	12	34	34	34	110	132	179	194	250	288	349

Lighting circuit switching

Contactor selection AF09 ... AF370 4-pole contactors

Selection table

4-pole AC / DC operated contactors			AF09	AF16	AF26	AF38	AF40	AF52	AF80	AF116	AF140	AF190	AF205	AF265	AF305	AF370
Lamp characteristics			Maximum permissible number of lamps per phase													
W	A	µF														

High pressure sodium vapour lamps without compensation

Voltage: 220/240 V AC

150	1.8	-	7	9	11	12	18	24	30	45	54	74	80	103	119	144
250	3.0	-	4	5	7	7	11	14	18	27	33	44	48	62	71	86
400	4.4	-	3	3	4	5	7	10	12	18	22	30	33	42	49	59
600	6.2	-	2	2	3	3	5	7	8	13	16	21	23	30	34	42
1000	10.3	-	1	1	2	2	3	4	5	8	10	13	14	18	21	25

High pressure sodium vapour lamps with parallel compensation

Voltage: 220/240 V AC

150	1.0	20	12	12	21	23	33	43	55	93	112	152	164	212	244	296
250	1.5	36	7	7	14	15	22	29	36	62	75	101	109	141	163	197
400	2.5	48	5	5	8	9	13	17	22	37	45	61	66	85	98	118
600	3.3	65	3	3	6	6	10	13	16	28	34	46	50	64	74	90
1000	6.2	100	2	2	3	3	5	7	8	15	18	25	26	34	39	48

High pressure mercury vapour lamps without compensation

Voltage: 220/240 V AC

50	0.60	-	22	28	35	38	55	73	91	152	190	261	333	380	475	570
80	0.80	-	16	21	26	28	41	55	68	114	143	196	249	285	356	428
125	1.15	-	11	14	18	20	28	38	47	79	99	136	173	198	248	297
250	2.15	-	6	7	9	10	15	20	25	42	53	73	93	106	133	159
400	3.25	-	4	5	6	7	10	13	16	28	35	48	61	70	88	105
700	5.40	-	2	3	3	4	6	8	10	17	21	29	37	42	53	63
1000	7.50	-	1	2	2	3	4	5	7	12	15	21	27	30	38	46

Voltage: 380/415 V AC

2000	8	-	1	2	2	2	4	5	6	11	14	20	25	29	36	43
------	---	---	---	---	---	---	---	---	---	----	----	----	----	----	----	----

High pressure mercury vapour lamps with compensation

Voltage: 220/240 V AC

50	0.28	7	36	36	75	79	117	157	196	326	407	560	713	814	1018	1221
80	0.43	8	31	31	48	53	76	102	127	212	265	365	464	530	663	795
125	0.66	10	20	25	31	34	50	66	83	138	173	238	302	345	432	518
250	1.28	18	10	13	16	17	25	34	42	71	89	122	156	178	223	267
400	2.05	25	6	8	10	11	16	21	26	44	56	76	97	111	139	167
700	3.55	40	3	4	5	6	9	12	15	26	32	44	56	64	80	96
1000	4.83	60	2	3	4	4	6	9	11	19	24	32	41	47	59	71

Voltage: 380/415 V AC

2000	5.45	35	2	3	3	4	6	8	10	17	21	29	37	42	52	63
------	------	----	---	---	---	---	---	---	----	----	----	----	----	----	----	----

Metal halide vapour lamps without compensation

Voltage: 220/240 V AC

250	3	-	4	5	7	7	11	14	18	27	33	46	58	67	83	100
400	4	-	3	4	5	5	8	11	13	20	25	34	44	50	63	75
1000	9.5	-	1	1	2	2	3	4	5	8	11	14	18	21	26	32
2000	16.5	-	0	1	1	1	2	2	3	5	6	8	11	12	15	18

Voltage: 380/415 V AC

2000	10.5	-	1	1	2	2	3	4	5	8	10	13	17	19	24	29
------	------	---	---	---	---	---	---	---	---	---	----	----	----	----	----	----

Metal halide vapour lamps with compensation

Voltage: 220/240 V AC

250	1.32	33	7	7	15	16	25	33	41	69	86	119	151	173	216	259
400	2.22	45	5	5	9	10	14	19	24	41	51	71	90	103	128	154
1000	5.14	85	2	3	4	4	6	8	10	18	22	30	39	44	55	67
2000	11.5	148	1	1	1	2	2	3	4	8	10	14	17	20	25	30

Voltage: 380/415 V AC

2000	6.10	60	2	2	3	3	5	7	9	15	19	26	33	37	47	56
------	------	----	---	---	---	---	---	---	---	----	----	----	----	----	----	----

Parallel connection of main poles

General

Purpose: Increasing the AC resistive load by wiring connection of main poles in parallel.

Remarks:

- Parallel connection of main poles to increase the DC resistive load is not acceptable
- Parallel connection of main poles does not increase the breaking capacity.

The table below shows the uprating factor for $I_e / AC-1$ max. in relation to the number of poles wired connected in parallel and for a maximum switching frequency.

Note: The poles can be connected in parallel via following connecting strips. See details and permissible current in "Accessory" part.

- LP, LH, LY and LF for parallel connection of 2 or 3 poles
- LG for parallel connection of 4 poles.

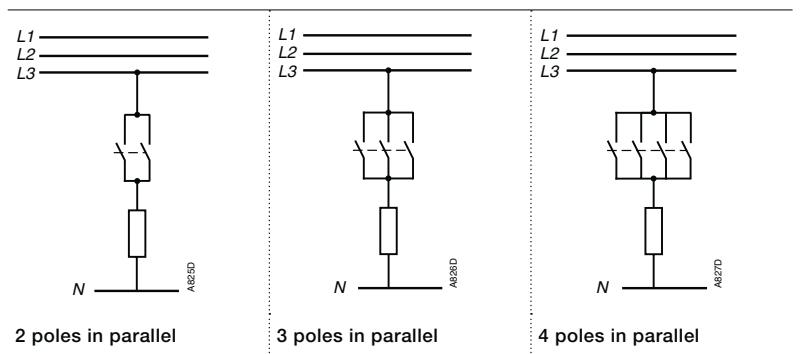

Contactors

Factor to be applied to the rated operational current $I_e / AC-1$ to obtain the permissible current $I_e / AC-1$ with "n" poles in parallel

AC operated	DC operated	Cycles / h			
3-pole contactors					
AF09 ... AF96	AF09 ... AF96	600	1.6	2.2	-
AF116 ... AF1250	AF116 ... AF1250	300	1.6	2.2	-
AF1350 ... AF2650	AF1350 ... AF2650	30	1.6	2.2	-
4-pole contactors					
AF09 ... AF38	AF09 ... AF38	600	1.6	2.2	2.6
A45 ... A75					
AF45 ... AF75	AE45 ... AE75 TAE45 ... TAE75 AF45 ... AF75	300	1.6	2.2	2.6
EK	EK	300	1.6	2.2	2.8

Temporary or intermittent duty

Utilization of contactors for temporary / intermittent duty

The table below shows the factor (known as "On-load factor") to be applied to the rated operational current $I_e / AC-1$ to obtain the permissible operational current $I_e / AC-1$ in relation to the switching frequency and the current flow time per cycle.

Operating cycles per hour	1	2	3	6	12	20	30	60	120
Preferred classes acc. to IEC 60947-4-1	1	–	3	–	12	–	30	–	120
Current flow time per cycle	Factors applicable to $I_e / AC-1$								
5 s	5.2	5	4.9	4.7	4.3	4.0	3.7	3.4	2.8
10 s	3.8	3.7	3.6	3.4	3.1	3.0	2.8	2.6	2.2
20 s	2.8	2.7	2.7	2.6	2.5	2.4	2.2	2.0	1.5
30 s	2.4	2.3	2.3	2.2	2.1	2.1	1.9	1.7	–
40 s	2.2	2.1	2.1	2.0	1.9	1.9	1.7	1.5	–
60 s	1.9	1.8	1.8	1.8	1.7	1.7	1.5	–	–

Example:

AF09 contactor (intermittent duty, resistive load)

Rated operational current $I_e / AC-1$ at 60 °C

(see "Technical data: main pole utilization characteristics") 25 A

Switching frequency 2 operating cycles/h

Current flow time per cycle 20 s

Factor to be applied to the current $I_e / AC-1$ 2.7

Permissible current: $2.7 \times 25 = 67$ A

Influence of the length of conductors used in contactor control circuit



AF40-30-00

Under certain conditions the excessive length of the control circuit conductors may prevent the contactor from carrying out closing and opening orders.

- **no closing:** due to excessive voltage drop (in AC or DC)
- **no opening:** due to excessive capacitance (in AC).

Contactor Closing (contactor with AC or DC operated coil).

The voltage drop is due to the pull-in current (pull-in power) and to the resistance of the control circuit conductors.

The table and graph below can be used to determine the **single length of line feeders** (distance between the control device and the contactor coil) in relation to:

- the coil pull-in consumption.
- the supply voltage.
- the connecting wire cross-sectional area.

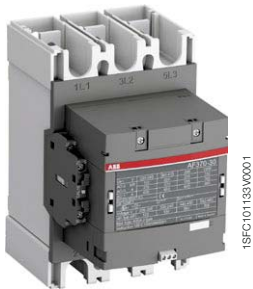

AF370-30-11

The graph has been drawn for a max. line voltage drop of 5 %.

Coil pull-in consumption (average value)

3-pole contactors	AC control supply	DC control supply	4-pole contactors	AC control supply	DC control supply
	50/60 Hz			50/60 Hz	
AF09, AF12, AF16, AF26, AF30, AF38	50 VA	50 W	AF09, AF16, AF26, AF38	50 VA	50 W
AF09Z, AF12Z, AF16Z, AF26Z, AF30Z, AF38Z	20 VA	20 W	AF09Z, AF16Z, AF26Z, AF38Z	20 W	20 W
AF40, AF52, AF65	25 VA	25 W	AF40, AF52, AF80	40 VA	40 W
AF80, AF96	40 VA	40 W	AF116, AF140	185 VA	170 W
AF116, AF140, AF146	180 VA	170 W	AF190, AF205	190 VA	180 W
AF190, AF205	195 VA	185 W	AF265, AF305, AF370	405 VA	445 W
AF265, AF305, AF370	405 VA	465 W			
AF400, AF460	1005 VA	960 W			
AF580, AF750, AF1250	940 VA	900 W			
AF1350, AF1650, AF2050, AF2650	2450 VA	2290 W			

Permissible single length for the control circuit conductors on contactor closing:

Depending on the coil pull-in power consumption on the supply voltage and on the DC control circuit conductor cross-sectional area.

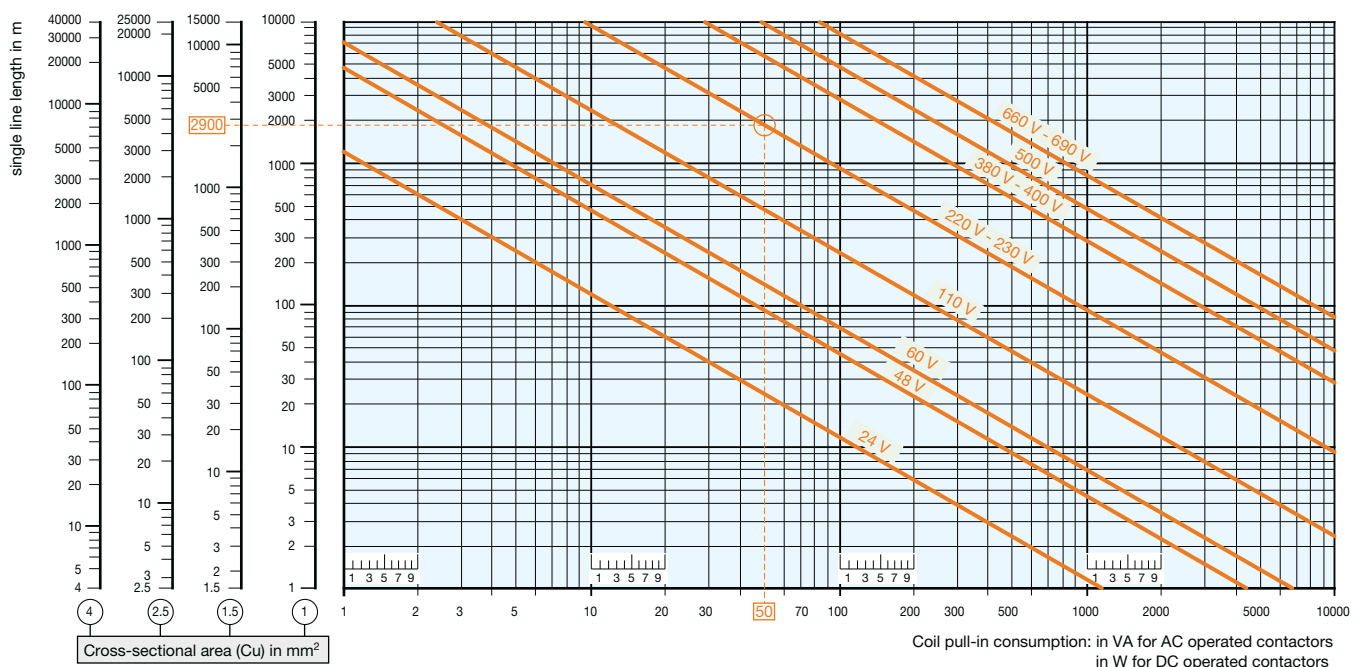

Example **AF09 contactor**: Coil voltage: 230 V 50 Hz, contactor coil pull-in power consumption: 50 VA, control circuit conductor cross-sectional area: Cu 1.5 mm². Max. permissible length: 2900 m.

Influence of the length of conductors used in contactor control circuit

Single control line length

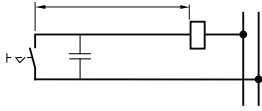

Wiring diagram A

Via maintained pushbutton and 2-core cable (with a capacity of 0.2 μF/km, for example).

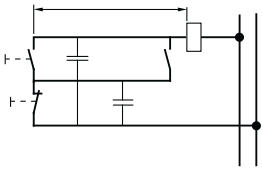

Wiring diagram B

Via momentary pushbutton plus hold-in contact and 3-core cable (with a capacity of 2 x 0.2 = 0.4 μF/km, for example).

Contactor Opening (contactor with AC operated coil)

Under certain conditions, an **AC operated** contactor does not open when the control circuit is de-energized.

This is due to a critical capacity of the excessively long control circuit line and the type of contactor coil control layout (see diagrams A and B opposite). This may be caused by the following factors:

- high control voltage
- low coil holding consumption
- low contactor drop-out voltage (according to IEC 60947-4-1: 0.2 to 0.75 x U_c).

If lines longer than those indicated are required, the following measures must be taken:

- select a contactor with a higher rating
- select a lower control voltage
- connect "R_p" resistance in parallel with the contactor coil:

$$R_p = \frac{10^3}{C} \quad (\text{with } C \text{ in } \mu\text{F})$$

The table and graph below can be used to determine the **single length of line feeders** (distance between the control device and the contactor coil) in relation to:

- the coil holding consumption VA
- the supply voltage
- the capacity in μF/km (depending on the control layout).

Wiring diagrams **A** and **B** opposite show two supply and coil control wiring examples.

Coil holding consumption (average value)

3-pole contactors	AC control supply 50/60 Hz	4-pole contactors	AC control supply 50/60 Hz
AF09, AF12, AF16, AF26, AF30, AF38	2.2 VA	AF09, AF16, AF26, AF38	2.2 VA
AF09Z, AF12Z, AF16Z, AF26Z, AF30Z, AF38Z	1.7 VA	AF09Z, AF16Z, AF26Z, AF38Z	1.7 VA
AF40, AF52, AF65, AF80, AF96	4 VA	AF40, AF52, AF80	4 VA
AF116, AF140, AF146	8.9 VA	AF116, AF140, AF190, AF205	8 VA
AF190, AF205	9.3 VA	AF265, AF305, AF370	16 VA
AF265, AF305, AF370	16.6 VA		
AF400, AF460, AF580, AF750, AF1250	12 VA		
AF1350, AF1650, AF2050, AF2650	48 VA		

Permissible single length for the control circuit conductors on contactor opening:

Depending on the coil holding power consumption, on the supply voltage and on the control circuit conductor capacity.

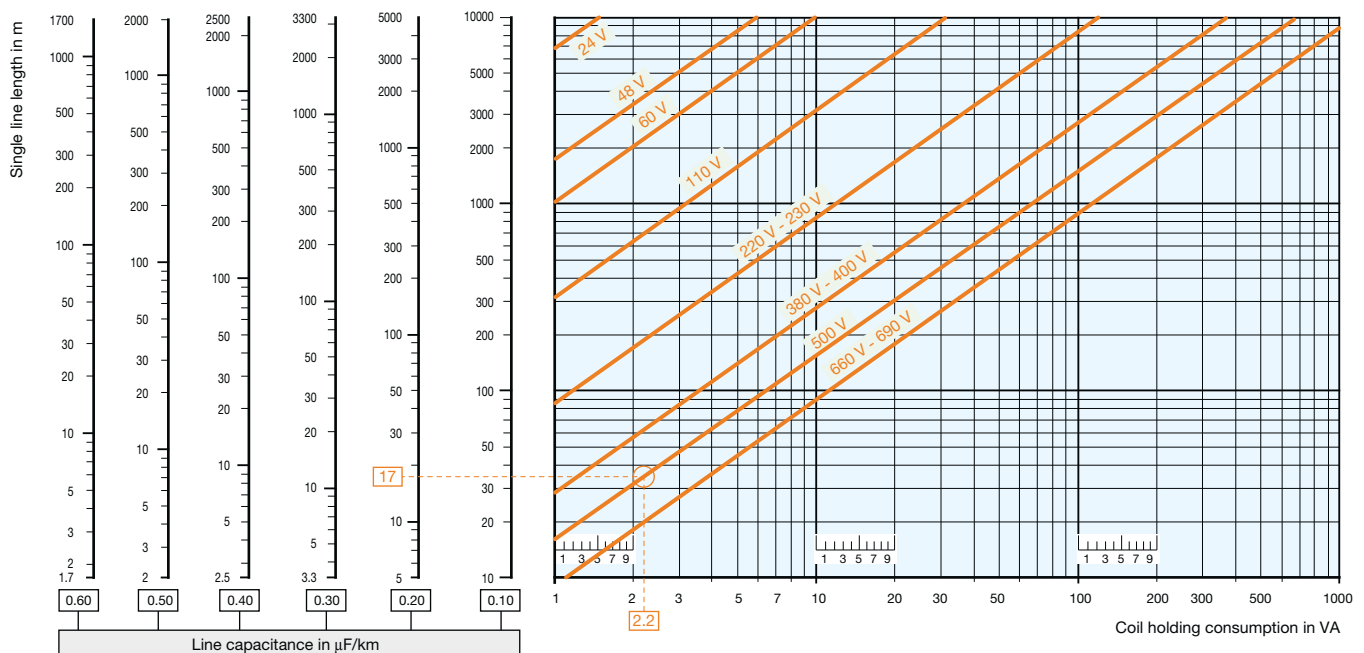

Example **AF16 contactor**: Coil voltage U_c = 500 V, 50 Hz, 2.2 VA contactor coil holding consumption, control type: diagram A, via maintained pushbutton, and 2-core cable with a capacity of 0.2 μF/km. Max. permissible length: 17 m.



NF 4-pole and 8-pole contactor relays

Ordering details 4-pole contactor relays

NF	AC / DC operated	5/318
NFZ	AC / DC operated - low consumption	5/319
Main accessories		5/320

Ordering details 8-pole contactor relays

NF	AC / DC operated	5/322
NFZ	AC / DC operated - low consumption	5/323
Main accessories		5/324

Technical data

Terminal marking and positioning

Main dimensions

Voltage code table

NF 4-pole contactor relays

AC / DC operated



NF22E

1SBCT10104R0014

Description

NF contactor relays are used for switching auxiliary and control circuits.

These contactor relays are of the block type design with:

- 4 poles. Contactor relays have mechanically linked auxiliary contact elements (side-marked symbol)
- control circuit: AC or DC operated with electronic coil interface accepting a wide control voltage range (e.g. 100...250 V AC and DC)
 - can manage large control voltage variations
 - only 4 control voltage ranges covering 24...500 V 50/60 Hz and 20...500 V DC
 - reduced panel energy consumption
 - very distinct closing and opening.
- built-in surge suppression
- add-on auxiliary contact blocks for front or side mounting and a wide range of accessories.

Ordering details

Number of contacts	Rated control circuit voltage		Type	Order code	Weight
	Uc min. ... Uc max.				
	V 50/60 Hz	V DC			kg
	24...60	-	(1) NF22E-41	1SBH137001R4122	0.270
	48...130	48...130	NF22E-12	1SBH137001R1222	0.270
	100...250	100...250	NF22E-13	1SBH137001R1322	0.270
	250...500	250...500	NF22E-14	1SBH137001R1422	0.310
	24...60	-	(1) NF31E-41	1SBH137001R4131	0.270
	48...130	48...130	NF31E-12	1SBH137001R1231	0.270
	100...250	100...250	NF31E-13	1SBH137001R1331	0.270
	250...500	250...500	NF31E-14	1SBH137001R1431	0.310
	24...60	-	(1) NF40E-41	1SBH137001R4140	0.270
	48...130	48...130	NF40E-12	1SBH137001R1240	0.270
	100...250	100...250	NF40E-13	1SBH137001R1340	0.270
	250...500	250...500	NF40E-14	1SBH137001R1440	0.310

(1) For 24...60 V 50/60 Hz - 20...60 V DC, use NF..E-21.

Main dimensions mm, inches

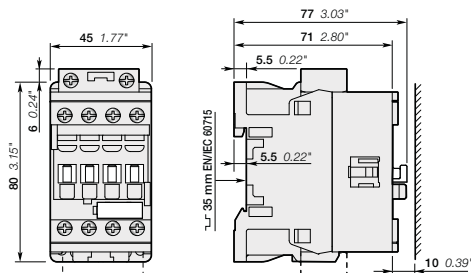

NF22E, NF31E, NF40E

1SBCT10156S0201 - Rev. B

NFZ 4-pole contactor relays

AC / DC operated - low consumption



NFZ22E

Description

NFZ contactor relays are used for switching auxiliary and control circuits.

These contactor relays are of the block type design with:

- 4 poles. Contactor relays have mechanically linked auxiliary contact elements (side-marked symbol)
- control circuit: AC or DC operated with electronic coil interface accepting a wide control voltage range (e.g. 100...250 V AC and DC)
 - can manage large control voltage variations
 - only 4 control voltage ranges covering 24...250 V 50/60 Hz and 12...250 V DC
 - allow direct control by PLC-output ≥ 24 V DC 500 mA
 - reduced panel energy consumption
 - very distinct closing and opening
 - can withstand short voltage dips and voltage sags (SEMI F47-0706 conditions of use on request).
- built-in surge suppression
- add-on auxiliary contact blocks for front or side mounting and a wide range of accessories.

Ordering details

Number of contacts	Rated control circuit voltage Uc min. ... Uc max.		Type	Order code	Weight Pkg (1 pce) kg
	V 50/60 Hz	V DC			
	-	12...20	NFZ22E-20	1SBH136001R2022	0.310
	24...60	20...60	NFZ22E-21	1SBH136001R2122	0.310
	48...130	48...130	NFZ22E-22	1SBH136001R2222	0.310
	100...250	100...250	NFZ22E-23	1SBH136001R2322	0.310
	-	12...20	NFZ31E-20	1SBH136001R2031	0.310
	24...60	20...60	NFZ31E-21	1SBH136001R2131	0.310
	48...130	48...130	NFZ31E-22	1SBH136001R2231	0.310
	100...250	100...250	NFZ31E-23	1SBH136001R2331	0.310
	-	12...20	NFZ40E-20	1SBH136001R2040	0.310
	24...60	20...60	NFZ40E-21	1SBH136001R2140	0.310
	48...130	48...130	NFZ40E-22	1SBH136001R2240	0.310
	100...250	100...250	NFZ40E-23	1SBH136001R2340	0.310

Note: Only NFZ contactor relays with DC control voltage 12...20 V DC need to respect the connection polarities indicated close to the coil terminals: A1+ for the positive pole and A2- for the negative pole.

Main dimensions mm, inches

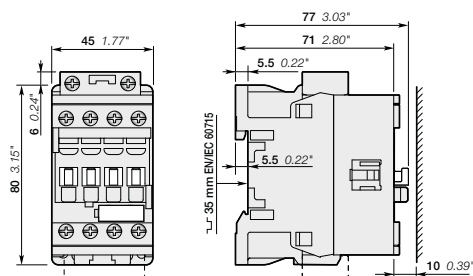

NFZ22E, NFZ31E, NFZ40E

NF 4-pole contactor relays

Main accessories

Contactor relays and main accessories (other accessories available)

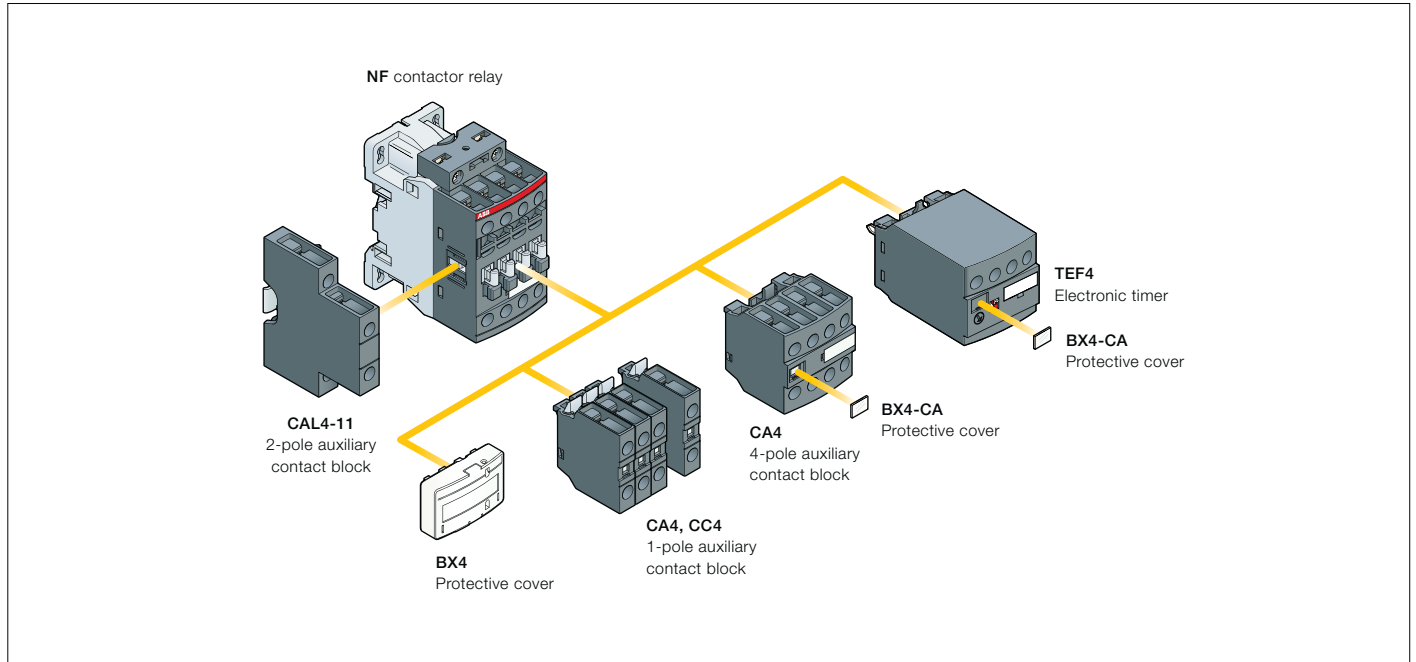

Main accessory fitting details

Many configurations of accessories are possible depending on whether these are front-mounted or side-mounted.

Contactor relay types	Main poles	Front-mounted accessories			Side-mounted accessories	
		Auxiliary contact blocks		Electronic timer	Auxiliary contact blocks	
		1-pole CA4	4-pole CA4	TEF4	Left side 2-pole CAL4-11	Right side
		Max. add-on N.C. auxiliary contacts: 3 N.C. max. on positions 1, 2, 3, 4 and 2 N.C. max. on positions 1 ±30°, 5				
NF	2 2 E	4 max.	or 1	or 1	+ 1	-
	3 1 E	2 max.	-	or 1	+ 1	+ 1
		Max. add-on N.C. auxiliary contacts: 4 N.C. max. on positions 1, 2, 3, 4 and 3 N.C. max. on positions 1 ±30°, 5				
NF	4 0 E	4 max.	or 1	or 1	+ 1	-
		2 max.	-	or 1	+ 1	+ 1

NF 4-pole contactor relays

Main accessories



CA4-10



CA4-22N



CAL4-11



TEF4-ON



LDC4



BX4



BX4-CA

Ordering details (1)

For contactor relays	Auxiliary contacts	Type	Order code	Pkg qty	Weight (1 pce)
					kg

Front-mounted instantaneous auxiliary contact blocks

4-pole NF	NO	NC	Type	Order code	Pkg qty	Weight (1 pce)
	1	0	CA4-10	1SBN010110R1010	1	0.014
	1	0	CA4-10-T	1SBN010110T1010	10	0.014
	0	1	CA4-01	1SBN010110R1001	1	0.014
	0	1	CA4-01-T	1SBN010110T1001	10	0.014
	4	0	CA4-40N	1SBN010140R1240	1	0.055
	3	1	CA4-31N	1SBN010140R1231	1	0.055
	2	2	CA4-22N	1SBN010140R1222	1	0.055
	1	3	CA4-13N	1SBN010140R1213	1	0.055
NF..40E	0	4	CA4-04N	1SBN010140R1204	1	0.055

Front-mounted auxiliary contact blocks with N.O. leading contact and N.C. lagging contact

4-pole NF	NO	NC	Type	Order code	Pkg qty	Weight (1 pce)
	-	-	CC4-10	1SBN010111R1010	1	0.014
	-	0	CC4-01	1SBN010111R1001	1	0.014

Side-mounted instantaneous auxiliary contact blocks

NF	NO	NC	Type	Order code	Pkg qty	Weight (1 pce)
	1	1	CAL4-11	1SBN010120R1011	1	0.040
	1	1	CAL4-11-T	1SBN010120T1011	10	0.040

For contactors	Time delay range selected by switch	Delay type	Auxiliary contacts	Type	Order code	Pkg qty	Weight (1 pce)
							kg

Electronic timers

NF	Time delay range	Delay type	NO	NC	Type	Order code	Pkg qty	Weight (1 pce)
	0.1...1 s	ON-delay	1	1	TEF4-ON	1SBN020112R1000	1	0.065
	1...10 s	OFF-delay	1	1	TEF4-OFF	1SBN020114R1000	1	0.065
	10...100 s							

Note: Rated control circuit voltage U_c 24...240 V 50/60 Hz or DC.

Additional coil terminal block

NF	Type	Order code	Pkg qty	Weight (1 pce)
	LDC4	1SBN070156T1000	10	0.010

Protective covers

All 1-stack contactor relays	Type	Order code	Pkg qty	Weight (1 pce)
	BX4	1SBN110108T1000	10	0.006
4-pole CA4 auxiliary contact blocks and TEF4 electronic timer	BX4-CA	1SBN110109W1000	50	0.001

(1) For more information, refer to main catalog "Accessories" section.

NF 8-pole contactor relays

AC / DC operated



NF44E

1SBCE101029V0014

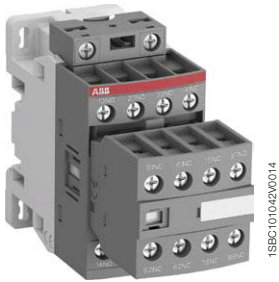

NF33/11

1SBCE101042V0014



NF51/11

1SBCE101043V0014

Description

NF contactor relays are used for switching auxiliary and control circuits.

These contactor relays are of the block type design with:

- 8 poles with a permanently fixed 4-pole auxiliary contact block. Contactor relays have mechanically linked auxiliary contact elements (side-marked symbol) except for NF33/11 and NF51/11 variants
- overlapping of lagging / leading contacts for NF33/11 and NF51/11 variants
- control circuit: AC or DC operated with electronic coil interface accepting a wide control voltage range (e.g. 100...250 V AC and DC)
 - can manage large control voltage variations
 - only 4 coils to cover control voltages between 24...500 V 50/60 Hz and 20...500 V DC
 - reduced panel energy consumption
 - very distinct closing and opening
- built-in surge suppression
- add-on auxiliary contact blocks for side mounting and a wide range of accessories.

Ordering details

Number of contacts	Rated control circuit voltage Uc min. ... Uc max.	Type	Order code	Weight	
					1st stack
		V 50/60 Hz	V DC		

8-pole contactor relays

	24...60	-	(1)	NF44E-41	1SBH137001R4144	0.320
	48...130	48...130		NF44E-12	1SBH137001R1244	0.320
	100...250	100...250		NF44E-13	1SBH137001R1344	0.320
	250...500	250...500		NF44E-14	1SBH137001R1444	0.360
	24...60	-	(1)	NF53E-41	1SBH137001R4153	0.320
	48...130	48...130		NF53E-12	1SBH137001R1253	0.320
	100...250	100...250		NF53E-13	1SBH137001R1353	0.320
	250...500	250...500		NF53E-14	1SBH137001R1453	0.360
	24...60	-	(1)	NF62E-41	1SBH137001R4162	0.320
	48...130	48...130		NF62E-12	1SBH137001R1262	0.320
	100...250	100...250		NF62E-13	1SBH137001R1362	0.320
	250...500	250...500		NF62E-14	1SBH137001R1462	0.360
	24...60	-	(1)	NF71E-41	1SBH137001R4171	0.320
	48...130	48...130		NF71E-12	1SBH137001R1271	0.320
	100...250	100...250		NF71E-13	1SBH137001R1371	0.320
	250...500	250...500		NF71E-14	1SBH137001R1471	0.360
	24...60	-	(1)	NF80E-41	1SBH137001R4180	0.320
	48...130	48...130		NF80E-12	1SBH137001R1280	0.320
	100...250	100...250		NF80E-13	1SBH137001R1380	0.320
	250...500	250...500		NF80E-14	1SBH137001R1480	0.360

8-pole contactor relays with overlapping of lagging / leading contacts

	24...60	-	(1)	NF33/11-41	1SBH137001R4139	0.320
	48...130	48...130		NF33/11-12	1SBH137001R1239	0.320
	100...250	100...250		NF33/11-13	1SBH137001R1339	0.320
	250...500	250...500		NF33/11-14	1SBH137001R1439	0.320
	24...60	-	(1)	NF51/11-41	1SBH137001R4159	0.320
	48...130	48...130		NF51/11-12	1SBH137001R1259	0.320
	100...250	100...250		NF51/11-13	1SBH137001R1359	0.320
	250...500	250...500		NF51/11-14	1SBH137001R1459	0.320

(1) For 24...60 V 50/60 Hz - 20...60 V DC, use NF..-21.

Main dimensions mm, inches

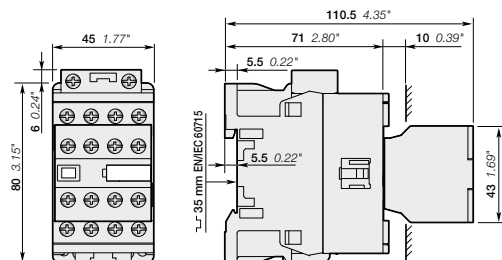

NF44E, NF53E, NF62E, NF71E, NF80E, NF33/11, NF51/11

NFZ 8-pole contactor relays

AC / DC operated



NFZ44E

1SBCT101029V0014



NFZ33/11

1SBCT101042V0014



NFZ51/11

1SBCT101043V0014

Description

NFZ contactor relays are used for switching auxiliary and control circuits.

These contactor relays are of the block type design with:

- 8 poles with a permanently fixed 4-pole auxiliary contact block. Contactor relays have mechanically linked auxiliary contact elements (side-marked symbol) except for NFZ33/11 and NFZ51/11 variants
- overlapping of lagging / leading contacts for NFZ33/11 and NFZ51/11 variants
- control circuit: AC or DC operated with electronic coil interface accepting a wide control voltage range (e.g. 100...250 V AC and DC)
 - can manage large control voltage variations
 - only 4 coils to cover control voltages between 24 ... 250 V 50/60 Hz and 12 ... 250 V DC
 - allow direct control by PLC-output ≥ 24 V DC 500 mA
 - reduced panel energy consumption
 - very distinct closing and opening
 - can withstand short voltage dips and voltage sags (SEMI F47-0706 conditions of use on request).
- built-in surge suppression
- add-on auxiliary contact blocks for side mounting and a wide range of accessories.

Ordering details

Number of contacts		Rated control circuit voltage Uc min. ... Uc max.	Type	Order code	Weight Pkg (1 pce) kg
1st stack	2nd stack				
		V 50/60 Hz	V DC		

8-pole contactor relays

	-	12...20	NFZ44E-20	1SBH136001R2044	0.360
	24...60	20...60	NFZ44E-21	1SBH136001R2144	0.360
	48...130	48...130	NFZ44E-22	1SBH136001R2244	0.360
	100...250	100...250	NFZ44E-23	1SBH136001R2344	0.360
	-	12...20	NFZ53E-20	1SBH136001R2053	0.360
	24...60	20...60	NFZ53E-21	1SBH136001R2153	0.360
	48...130	48...130	NFZ53E-22	1SBH136001R2253	0.360
	100...250	100...250	NFZ53E-23	1SBH136001R2353	0.360
	-	12...20	NFZ62E-20	1SBH136001R2062	0.360
	24...60	20...60	NFZ62E-21	1SBH136001R2162	0.360
	48...130	48...130	NFZ62E-22	1SBH136001R2262	0.360
	100...250	100...250	NFZ62E-23	1SBH136001R2362	0.360
	-	12...20	NFZ71E-20	1SBH136001R2071	0.360
	24...60	20...60	NFZ71E-21	1SBH136001R2171	0.360
	48...130	48...130	NFZ71E-22	1SBH136001R2271	0.360
	100...250	100...250	NFZ71E-23	1SBH136001R2371	0.360
	-	12...20	NFZ80E-20	1SBH136001R2080	0.360
	24...60	20...60	NFZ80E-21	1SBH136001R2180	0.360
	48...130	48...130	NFZ80E-22	1SBH136001R2280	0.360
	100...250	100...250	NFZ80E-23	1SBH136001R2380	0.360

8-pole contactor relays with overlapping of lagging / leading contacts

	-	12...20	NFZ33/11-20	1SBH136001R2039	0.360
	24...60	20...60	NFZ33/11-21	1SBH136001R2139	0.360
	48...130	48...130	NFZ33/11-22	1SBH136001R2239	0.360
	100...250	100...250	NFZ33/11-23	1SBH136001R2339	0.360
	-	12...20	NFZ51/11-20	1SBH136001R2059	0.360
	24...60	20...60	NFZ51/11-21	1SBH136001R2159	0.360
	48...130	48...130	NFZ51/11-22	1SBH136001R2259	0.360
	100...250	100...250	NFZ51/11-23	1SBH136001R2359	0.360

Note: Only NFZ contactor relays with DC control voltage 12...20 V DC need to respect the connection polarities indicated close to the coil terminals: A1+ for the positive pole and A2- for the negative pole

Main dimensions mm, inches

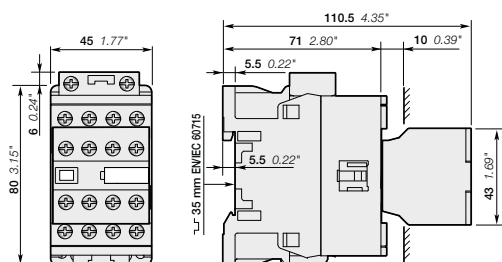

NFZ44E, NFZ53E, NFZ62E, NFZ71E, NFZ80E, NFZ33/11, NFZ51/11

NF 8-pole contactor relays

Main accessories

Contactor relays and main accessories (other accessories available)

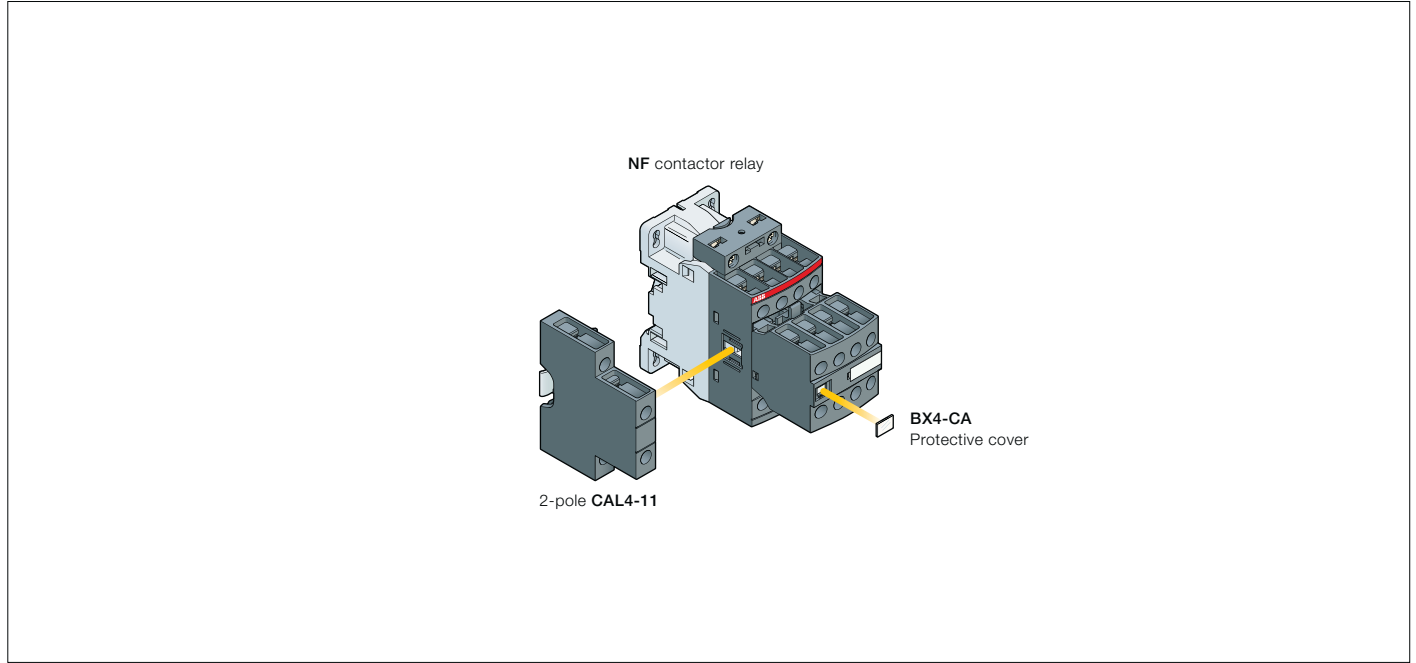

5

Main accessory fitting details

Many configurations of accessories are possible depending on whether these are front-mounted or side-mounted.

Contactor relay types	Main poles	Front-mounted accessories		Side-mounted accessories	
		Auxiliary contact blocks		Auxiliary contact blocks	
		1-pole CA4 1-pole CC4	4-pole CA4	Left side 2-pole CAL4-11	Right side
NF	4 4 E 5 3 E 6 2 E 7 1 E 8 0 E 3 3 / 1 1 5 1 / 1 1	-	-	+	1 -

NF 8-pole contactor relays

Main accessories



CAL4-11







LDC4



BX4-CA

Ordering details (1)

For contactor relays	Auxiliary contacts	Type	Order code	Pkg qty	Weight (1 pce)
	 	 			kg

Side-mounted instantaneous auxiliary contact blocks

NF	1 1	- -	CAL4-11	1SBN010120R1011	1	0.040
	1 1	- -	CAL4-11-T	1SBN010120T1011	10	0.040

Additional coil terminal block

NF		LDC4	1SBN070156T1000	10	0.010
----	--	------	-----------------	----	-------

Protective covers

NF		BX4-CA	1SBN110109W1000	50	0.001
----	--	--------	-----------------	----	-------

(1) For more information, refer to "Accessories" section.

NF contactor relays

Technical data

Contact utilization characteristics according to IEC

Contactor relay types	AC / DC operated	NF
Standards	IEC 60947-1 / 60947-5-1 and EN 60947-1 / 60947-5-1	
Rated operational voltage U_e max.	690 V	
Rated frequency (without derating)	50 / 60 Hz	
Conventional free-air thermal current I_{th} $\theta \leq 40$ °C	16 A	
le / Rated operational current AC-15 acc. to IEC 60947-5-1	24-127 V 50/60 Hz	6 A
	220-240 V 50/60 Hz	4 A
	400-440 V 50/60 Hz	3 A
	500 V 50/60 Hz	2 A
	690 V 50/60 Hz	2 A
Rated making capacity AC-15	10 x le AC-15 acc. to IEC 60947-5-1	
Rated breaking capacity AC-15	10 x le AC-15 acc. to IEC 60947-5-1	
le / Rated operational current DC-13 acc. to IEC 60947-5-1	24 V DC	6 A / 144 W
	48 V DC	2.8 A / 134 W
	72 V DC	1 A / 72 W
	110 V DC	0.55 A / 60 W
	125 V DC	0.55 A / 69 W
	220 V DC	0.27 A / 60 W
	250 V DC	0.27 A / 68 W
	400 V DC	0.15 A / 60 W
	500 V DC	0.13 A / 65 W
	600 V DC	0.1 A / 60 W
Short-circuit protection device gG type fuse	10 A	
Rated short-time withstand current I_{cw}	for 1.0 s	100 A
	for 0.1 s	140 A
Minimum switching capacity with failure rate acc. to IEC 60947-5-4	12 V / 3 mA 10^{-7}	
Non-overlapping time between N.O. and N.C. contacts	≥ 2 ms	
Power dissipation per pole at 6 A	0.1 W	
Max. electrical switching frequency	AC-15	1200 cycles/h
	DC-13	900 cycles/h
Mechanically linked contacts acc. to annex L of IEC 60947-5-1	Built-in N.O. or N.C. auxiliary contacts and additional N.O. or N.C. auxiliary contacts (CA4, CAL4 aux. contact blocks) are mechanically linked contacts.	

Contact utilization characteristics according to UL / CSA

Contactor relay types	AC / DC operated	NF
Standards	UL 508, CSA C22.2 N°14	
Max. operational voltage	600 V AC, 600 V DC	
Pilot duty	A600, Q600	
AC thermal rated current	10 A	
AC maximum volt-ampere making	7200 VA	
AC maximum volt-ampere breaking	720 VA	
DC thermal rated current	2.5 A	
DC maximum volt-ampere making-breaking	69 VA	

NF contactor relays

Technical data

General technical data

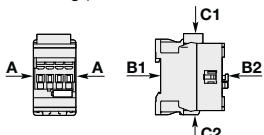
Contactor relay types	AC / DC operated	NF
Rated insulation voltage U_i acc. to IEC 60947-5-1 acc. to UL / CSA		690 V 600 V
Rated impulse withstand voltage U_{imp}		6 kV
Electromagnetic compatibility		Devices complying with IEC 60947-1 / EN 60947-1 - Environment A and B (1)
Ambient air temperature close to contactor relay		
Operation in free air		-40...+70 °C
Storage		-60...+80 °C
Climatic withstand		Category B according to IEC 60947-1 Annex Q
Maximum operating altitude (without derating)		3000 m
Mechanical durability		
Number of operating cycles		20 millions operating cycles
Max. switching frequency		6000 cycles/h
Shock withstand acc. to IEC 60068-2-27 and EN 60068-2-27		
Mounting position 1		
	Shock direction	1/2 sinusoidal shock for 11 ms: no change in contact position, closed or open position
	A	30 g
	B1	25 g closed position / 5 g open position
	B2	15 g
	C1	25 g
	C2	25 g
Vibration withstand acc. to IEC 60068-2-6		5...300 Hz 4 g closed position / 2 g open position

(1) Environment B: all NF contactor relays produced since week 08-2013. NF..E-12 (48...130 V 50/60 Hz-DC) compliant to environment A only.
For environment B: select NF..E-22.

Magnet system characteristics

Contactor relay types	AC / DC operated	NF
Coil operating limits acc. to IEC 60947-5-1	AC supply	At $\theta \leq 60$ °C $0.85 \times U_c \text{ min...} 1.1 \times U_c \text{ max.}$ At $\theta \leq 70$ °C $0.85 \times U_c \text{ min...} U_c \text{ max.}$
	DC supply	At $\theta \leq 60$ °C $0.85 \times U_c \text{ min...} 1.1 \times U_c \text{ max.}$ At $\theta \leq 70$ °C (AF) $0.85 \times U_c \text{ min...} U_c \text{ max.}$ - (NFZ) $0.85 \times U_c \text{ min...} 1.1 \times U_c \text{ max.}$
AC control voltage 50/60 Hz		
Rated control circuit voltage U_c		24...500 V AC
Coil consumption	Average pull-in value	(NF) 50 VA - (NFZ) 16 VA
	Average holding value	(NF) 2.2 VA / 2 W - (NFZ) 1.7 VA / 1.5 W
DC control voltage		
Rated control circuit voltage U_c		12...500 V DC
Coil consumption	Average pull-in value	(NF) 50 W - (NFZ) 12...16 W
	Average holding value	(NF) 2 W - (NFZ) 1.7 W
PLC-output control		(NFZ) ≥ 500 mA 24 V DC
Drop-out voltage		≤ 60 % of $U_c \text{ min.}$
Voltage sag immunity acc. to SEMI F47-0706		(NFZ) conditions of use on request
Dips withstand -20 °C $\leq \theta \leq +60$ °C		(NFZ) 22 ms average for $U_c \geq 24$ V 50/60 Hz or $U_c \geq 20$ V DC
Operating time		
Between coil energization and:	N.O. contact closing	40...95 ms
	N.C. contact opening	38...90 ms
Between coil de-energization and:	N.O. contact opening	11...95 ms
	N.C. contact closing	13...98 ms



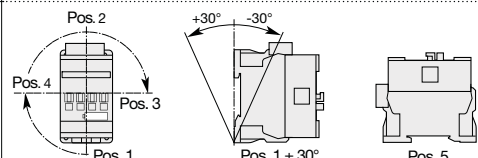





Mounting characteristics

Contactor relay types	AC / DC operated	NF
Mounting positions		
Mounting distances		Max. add-on N.C. auxiliary contacts: see accessory fitting details for a NF contactor relay
Fixing		The contactor relays can be assembled side by side.
On rail according to IEC 60715, EN 60715		35 x 7.5 mm or 35 x 15 mm
By screws (not supplied)		2 x M4 screws placed diagonally

NF contactor relays

Technical data

Connecting characteristics

Contactor relay types	AC / DC operated	NF
Main terminals		 Screw terminals with cable clamp
Connection capacity (min. ... max.)		
Pole and coil terminals		
 Rigid	1 x	1...2.5 mm ²
 Rigid	2 x	1...2.5 mm ²
 Flexible with non insulated ferrule	1 x	0.75...2.5 mm ²
 Flexible with non insulated ferrule	2 x	0.75...2.5 mm ²
 Flexible with insulated ferrule	1 x	0.75...2.5 mm ²
 Flexible with insulated ferrule	2 x	0.75...1.5 mm ²
 Lugs	L <	8 mm
Connection capacity acc. to UL/CSA	1 or 2 x	AWG 18...14
Stripping length		10 mm
Tightening torque		
Pole terminals		1.2 Nm / 11 lb.in
Coil terminals		1.2 Nm / 11 lb.in
Degree of protection		
acc. to IEC 60947-1 / EN 60947-1 and IEC 60529 / EN 60529		
All terminals		IP20
Screw terminals		
All terminals		Delivered in open position, screws of unused terminals must be tightened
		M3.5
	Screwdriver type	Flat Ø 5.5 / Pozidriv 2

NF contactor relays

Terminal marking and positioning

Standard devices without addition of auxiliary contacts

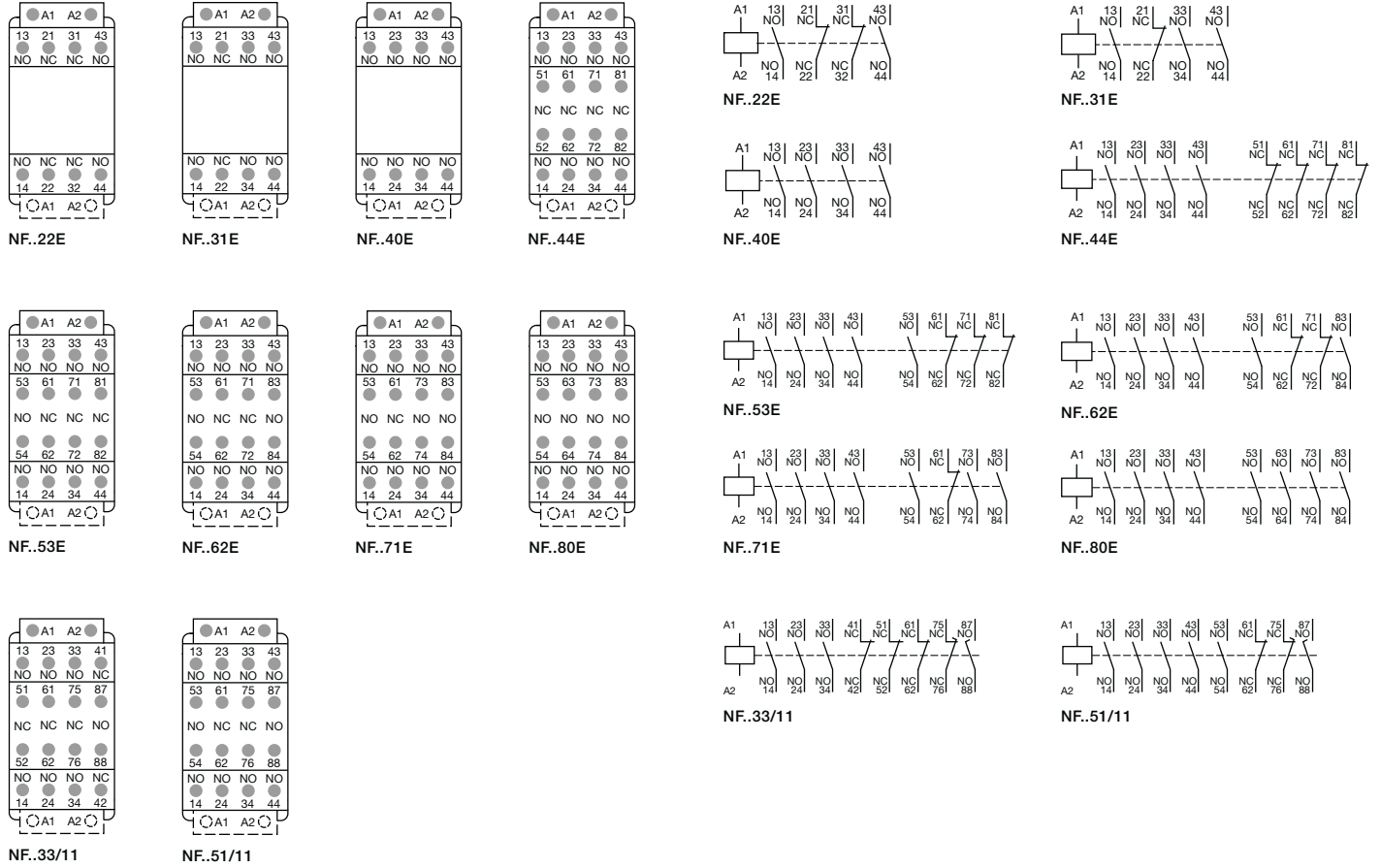

Other possible contact combinations with auxiliary contacts added by the user

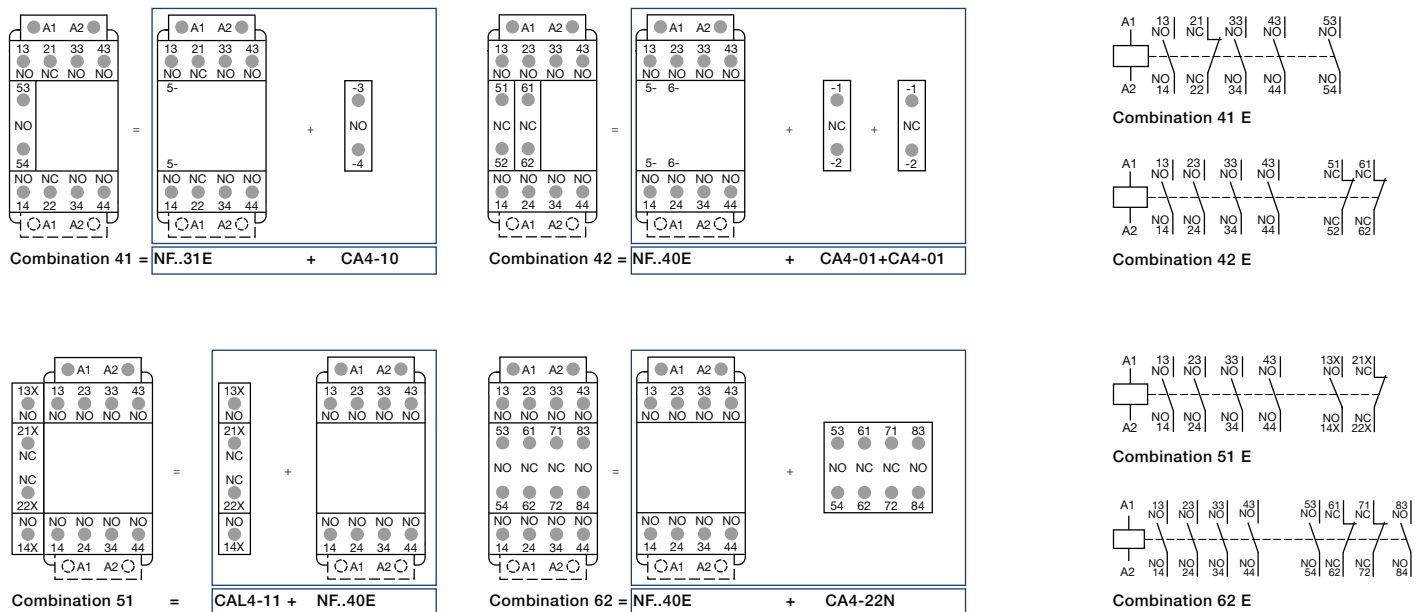

Note: Only NFZ contactor relays with DC control voltage 12...20 V DC need to respect the connection polarities indicated close to the coil terminals: A1+ for the positive pole and A2- for the negative pole

NF add-on auxiliary contacts

Terminal marking and positioning

1-pole auxiliary contacts

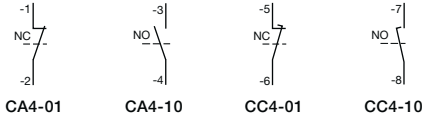

2-pole auxiliary contacts

5

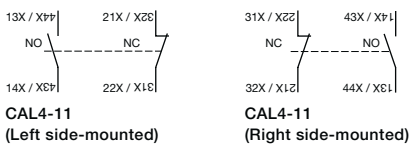

4-pole auxiliary contacts

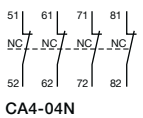
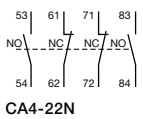
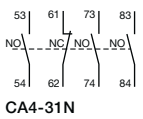
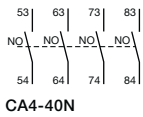
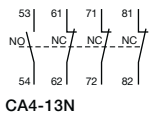

NF contactor relays

Main dimensions mm, inches

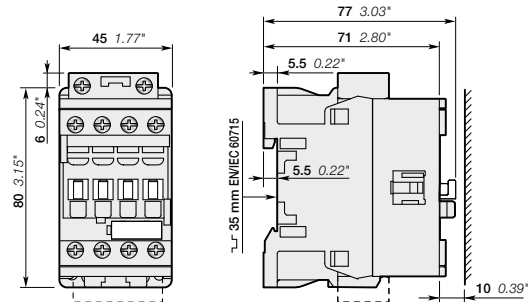

NF..22E, NF..31E, NF..40E

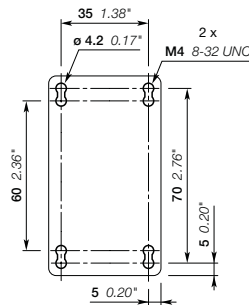

NF

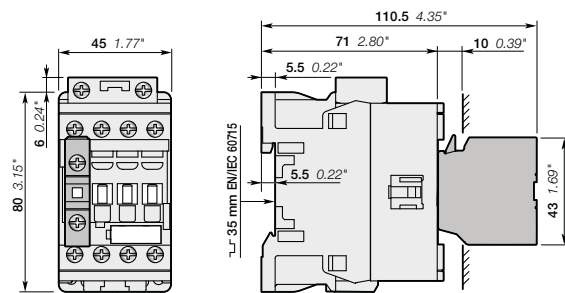

NF..22E, NF..31E, NF..40E
+ CA4, CC4 1-pole auxiliary contact block

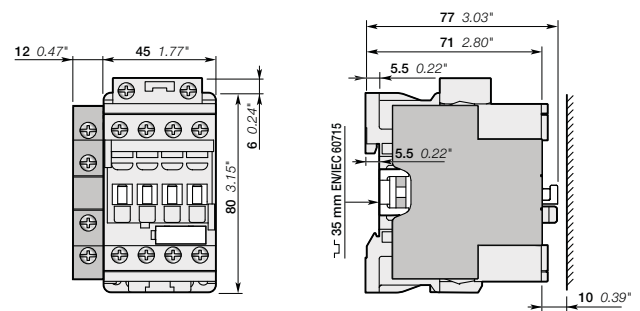

NF..22E, NF..31E, NF..40E
+ CAL4-11 2-pole auxiliary contact block

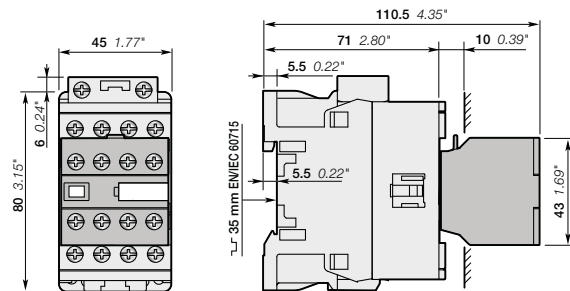

NF..22E, NF..31E, NF..40E
+ CA4 4-pole auxiliary contact block

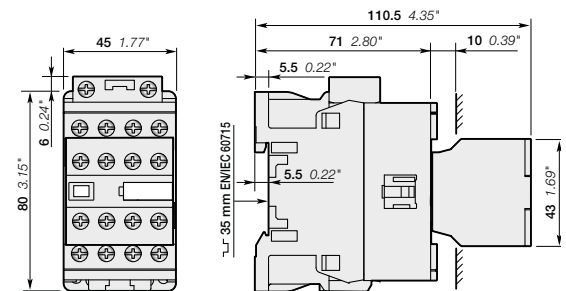

NF..44E, NF..53E, NF..62E, NF..71E, NF..80E, NF..33/11, NF..51/11

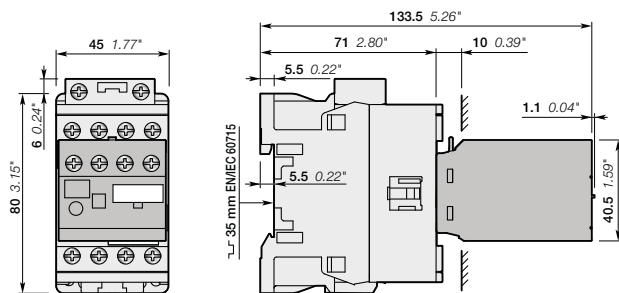

NF..22E, NF..31E, NF..40E
+ TEF4 electronic timer

Note: Contactor relay lateral distance to grounded component 2 mm 0.08" min.

Accessories for AF09 ... AF2650 3-pole contactors, AF09 ... AF370 4-pole contactors and NF contactor relays

Auxiliary contact blocks	5/336
Electronic timers	5/349
Interlocks	5/352
Impulse contact blocks	5/354
Interface relays	5/356
Mechanical latching units	5/358
Other accessories	5/360
Additional terminal blocks	5/362
Terminal shrouds	5/363
Terminals for control lead connections	5/364
Connections	5/365
Terminal connecting strips and shorting bars	5/366
Connection accessories for starting solutions	5/367
Connection sets for star-delta starter	5/368
Connection bars	5/369
Mounting plates	5/370
Adapter plates	5/371
Low Voltage Ride Through (LVRT) modules	5/372
Contactor coils, main contact sets and arc chutes	5/373

Accessories for UA, UA..RA, GA75, GAE75, GAF contactors

Auxiliary contact blocks	5/376
Electronic timers	5/382
Mechanical and electrical interlock units	5/385
CA5, CE5, CAL, CEL18 and TEF5 fitting details	5/387
Function markers - Mounting piece	5/388
Surge suppressors for contactor coils	5/389
Interface relays	5/391
Mechanical latching units	5/393
Additional terminal blocks and others accessories	5/395
Terminals for control lead connections	5/396
Contactor coils and main contact sets	5/397

Accessories for EK550, EK1000 4-pole contactors

Auxiliary contact blocks	5/400
Mechanical interlock units, terminal shrouds and connection sets	5/404
Surge suppressors for contactor coils	5/406
Main contact sets - Arc chutes	5/408
Contactor coils	5/409

Voltage code table	5/410
---------------------------	--------------

Accessories for AF09 ... AF2650 3-pole contactors, AF09 ... AF370 4-pole contactors and NF contactor relays

Auxiliary contact blocks	5/336
Electronic timers	5/349
Interlocks	5/352
Impulse contact blocks	5/354
Interface relays	5/356
Mechanical latching units	5/358
Other accessories	5/360
Additional terminal blocks	5/362
Terminal shrouds	5/363
Terminals for control lead connections	5/364
Connections	5/365
Terminal connecting strips and shorting bars	5/366
Connection accessories for starting solutions	5/367
Connection sets for star-delta starter	5/368
Connection bars	5/369
Mounting plates	5/370
Adapter plates	5/371
Low Voltage Ride Through (LVRT) modules	5/372
Contactor coils, main contact sets and arc chutes	5/373

Auxiliary contact blocks for AF09 ... AF96 contactors and NF contactor relays



CA4-10



CAL4-11



CA4-22E



CAT4-11E

Description

The auxiliary contact blocks are used for the operation of auxiliary circuits and control circuits for standard industrial environments.

Types of auxiliary contact blocks for front mounting:

- CA4 1 or 4-pole block, with instantaneous N.O., N.C. contacts
- CC4 1-pole block, with N.O. leading contact or N.C. lagging contact
- CAT4 2-pole block, with instantaneous N.O. + N.C. contacts and A1 / A2 coil terminal connection on front face.

Select the 4-pole auxiliary contact blocks CA4-..E, CA4-..M, CA4-..U or CA4-..N type, according to the contactor or contactor relay type for compliance with the standard requirements (see "Terminal marking and positioning").

Types of auxiliary contact blocks for side mounting:

- CAL4 2-pole block, with instantaneous N.O. + N.C. contacts.

For clipping onto the right- and/or left-hand side of the contactors.

The auxiliary contact blocks are equipped with screw type connecting terminals delivered open, protected against accidental direct contact and bear the corresponding function marking.

Ordering details (1)

For contactors	Auxiliary contacts	Type	Order code	Pkg qty	Weight (1 pce)
					kg

Front-mounted instantaneous auxiliary contact blocks

AF09 ... AF96	1 0 - -	CA4-10	1SBN010110R1010	1	0.014
4-pole NF	1 0 - -	CA4-10-T	1SBN010110T1010	10	0.014
	0 1 - -	CA4-01	1SBN010110R1001	1	0.014
	0 1 - -	CA4-01-T	1SBN010110T1001	10	0.014
AF09 ... AF16..-30-10	2 2 - -	CA4-22M	1SBN010140R1122	1	0.055
	3 1 - -	CA4-31M	1SBN010140R1131	1	0.055
	1 3 - -	CA4-13M	1SBN010140R1113	1	0.055
	0 4 - -	CA4-04M	1SBN010140R1104	1	0.055
AF26 ... AF96..-30-00	2 2 - -	CA4-22E	1SBN010140R1022	1	0.055
AF09 ... AF80..-40-00	3 1 - -	CA4-31E	1SBN010140R1031	1	0.055
AF09 ... AF80..-22-00	4 0 - -	CA4-40E	1SBN010140R1040	1	0.055
AF26 ... AF96..-30-00	0 4 - -	CA4-04E	1SBN010140R1004	1	0.055
AF09 ... AF16..-40-00					
AF40 ... AF80..-40-00					
AF09 ... AF16..-30-01	2 2 - -	CA4-22U	1SBN010140R1322	1	0.055
	3 1 - -	CA4-31U	1SBN010140R1331	1	0.055
	4 0 - -	CA4-40U	1SBN010140R1340	1	0.055
4-pole NF	2 2 - -	CA4-22N	1SBN010140R1222	1	0.055
	3 1 - -	CA4-31N	1SBN010140R1231	1	0.055
	4 0 - -	CA4-40N	1SBN010140R1240	1	0.055
	1 3 - -	CA4-13N	1SBN010140R1213	1	0.055
NF..40E	0 4 - -	CA4-04N	1SBN010140R1204	1	0.055

Front-mounted auxiliary contact blocks with N.O. leading contact and N.C. lagging contact

AF09 ... AF96	- - 1 0	CC4-10	1SBN010111R1010	1	0.014
4-pole NF	- - 0 1	CC4-01	1SBN010111R1001	1	0.014

Side-mounted instantaneous auxiliary contact blocks

AF09 ... AF96	1 1 - -	CAL4-11	1SBN010120R1011	1	0.040
NF	1 1 - -	CAL4-11-T	1SBN010120T1011	10	0.040

Front-mounted instantaneous auxiliary contact and A1/A2 coil terminal blocks

AF09 ... AF16..-30-10	1 1 - -	CAT4-11M	1SBN010151R1111	1	0.040
AF26 ... AF65..-30-00	1 1 - -	CAT4-11E	1SBN010151R1011	1	0.040
AF09 ... AF52..-40-00					
AF09 ... AF40..-22-00					
AF09 ... AF16..-30-01	1 1 - -	CAT4-11U	1SBN010151R1311	1	0.040

(1) For each contactor or contactor relay type, refer to "Accessory fitting details" table.

Note: CAT4 not suitable for AF..Z contactors with DC control voltage 12...20 V DC.

Auxiliary contact blocks for AF09 ... AF96 contactors and NF contactor relays

Technical data





Contact utilization characteristics according to IEC

Types	1-pole CA4 , 1-pole CC4 , 4-pole CA4 , 2-pole CAT4 , 2-pole CAL4	
Standards	IEC 60947-5-1 and EN 60947-5-1	
Rated insulation voltage U_i acc. to IEC 60947-5-1	690 V	
Rated impulse withstand voltage U_{imp}	6 kV	
Rated operational voltage U_e max.	24...690 V	
Conventional thermal current I_{th} - $\theta \leq 40^\circ\text{C}$	16 A	
Rated frequency (without derating)	50/60 Hz	
I_e / Rated operational current AC-15 acc. to IEC 60947-5-1	24-127 V 50/60 Hz	6 A
	220-240 V 50/60 Hz	4 A
	400-440 V 50/60 Hz	3 A
	500 V 50/60 Hz	2 A
	690 V 50/60 Hz	2 A
Making capacity acc. to IEC 60947-5-1	10 x I_e AC-15	
Breaking capacity acc. to IEC 60947-5-1	10 x I_e AC-15	
I_e / Rated operational current DC-13 acc. to IEC 60947-5-1	24 V DC	6 A / 144 W
	48 V DC	2.8 A / 134 W
	72 V DC	1 A / 72 W
	110 V DC	0.55 A / 60 W
	125 V DC	0.55 A / 69 W
	220 V DC	0.27 A / 60 W
	250 V DC	0.27 A / 68 W
	400 V DC	0.15 A / 60 W
	500 V DC	0.13 A / 65 W
	600 V DC	0.1 A / 60 W
Short-circuit protection device gG type fuse	10 A	
Rated short-time withstand current I_{cw} $\theta = 40^\circ\text{C}$	for 1.0 s	100 A
	for 0.1 s	140 A
Minimum switching capacity with failure rate acc. to IEC 60947-5-4	12 V / 3 mA	
Power dissipation per pole at 6 A	10-7	
Mechanical durability	Number of operating cycles	10 millions operating cycles
	Max. switching frequency	3600 cycles/h
Max. electrical switching frequency	AC-15	1200 cycles/h
	DC-13	900 cycles/h
Mechanically linked contacts acc. to annex L of IEC 60947-5-1	Additional N.O. or N.C. auxiliary contacts (CA4, CAL4, CAT4) are mechanically linked contacts	
Mirror contacts acc. to annex F of IEC 60947-4-1	Additional N.C. auxiliary contacts (CA4, CAL4, CAT4) are mirror contacts	

Contact utilization characteristics according to UL / CSA

Types	1-pole CA4 , 1-pole CC4 , 4-pole CA4 , 2-pole CAT4 , 2-pole CAL4	
Standards	UL 508, CSA C22.2 N°14	
Max. operational voltage	600 V AC, 600 V DC	
Pilot duty	A600, Q600	
AC thermal rated current	10 A	
AC maximum volt-ampere making	7200 VA	
AC maximum volt-ampere breaking	720 VA	
DC thermal rated current	2.5 A	
DC maximum volt-ampere making-breaking	69 VA	

Connecting characteristics

Types	1-pole CA4 , 1-pole CC4 , 4-pole CA4 , 2-pole CAT4 , 2-pole CAL4	
Connection capacity (min. ... max.)		
 Rigid solid	1 x	1...2.5 mm ²
	2 x	1...2.5 mm ²
 Flexible with non insulated ferrule	1 x	0.75...2.5 mm ²
	2 x	0.75...2.5 mm ²
 Flexible with insulated ferrule	1 x	0.75...2.5 mm ²
	2 x	0.75...1.5 mm ²
 Lugs	L <	8 mm
Connection capacity acc. to UL/CSA	1 or 2 x	AWG 18...14
Stripping length	10 mm	
Tightening torque	1.2 Nm / 1.1 lb.in	
Degree of protection acc. to IEC 60947-1 / EN 60947-1 and IEC 60529 / EN 60529	IP20	
Screw terminals All terminals	Delivered in open position, screws of unused terminals must be tightened M3.5	
Screwdriver type	Flat Ø 5.5 / Pozidriv 2	

Auxiliary contact blocks for severe industrial environments for AF09 ... AF96 contactors and NF contactor relays



Description

The auxiliary contact blocks are used for the operation of auxiliary circuits and control circuits for severe industrial environments.

Types of auxiliary contact blocks for front mounting:

- CE5 1-pole block, instantaneous with N.O. contact or N.C. contact, available in 2 IP degrees
 - CE5 D with built-in microswitch IP40, degree of protection (IP20 on terminals)
 - CE5 W with built-in microswitch IP67, degree of protection (IP20 on terminals).

The auxiliary contact blocks are equipped with screw type connecting terminals delivered open, protected against accidental direct contact and bear the corresponding function marking.

Ordering details (1)

For contactors	Auxiliary contacts		Type	Order code	Pkg qty	Weight (1 pce)
AF09 ... AF96 NF	1	- - -	CE5-10D0.1	1SBN010015R1010	1	0.020
	- 1	- - -	CE5-01D0.1	1SBN010015R1001	1	0.020
	1	- - -	CE5-10D2	1SBN010017R1010	1	0.020
	- 1	- - -	CE5-01D2	1SBN010017R1001	1	0.020
	1	- - -	CE5-10W0.1	1SBN010016R1010	1	0.020
	- 1	- - -	CE5-01W0.1	1SBN010016R1001	1	0.020
	1	- - -	CE5-10W2	1SBN010018R1010	1	0.020
	- 1	- - -	CE5-01W2	1SBN010018R1001	1	0.020

(1) For each contactor type, refer to "Accessory fitting details" table.

Main dimensions mm, inches

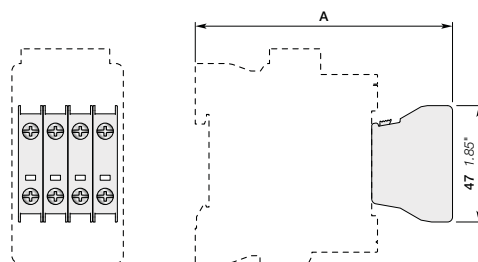

1-pole CE5 on	A
AF09 ... AF16..-30-xx 1 stack AF09, AF16..-40/22-00 NF..E 1-stack	103.5 mm / 4.07"
AF26 ... AF38..-30-00	112.5 mm / 4.43"
AF26, AF38..-40/22-00	127.5 mm / 5.02"
AF40 ... AF65-30-00	137 mm / 5.39"
AF40 ... AF65-40/22-00	140 mm / 5.51"
AF80 ... AF96-30-00	142 mm / 5.59"
AF80-40/22-00	142 mm / 5.59"

Auxiliary contact blocks for severe industrial environments

Technical data

Types	Front mounted 1-pole CE5-..0.1	1-pole CE5-..2
-------	-----------------------------------	----------------



Contact utilization characteristics according to IEC

Standards	IEC 60947-5-1 and EN 60947-5-1	
Rated insulation voltage U_i acc. to IEC 60947-5-1	250 V	
Rated operational voltage U_e max.	125 V	250 V
Conventional thermal current $I_{th} - \theta \leq 40^\circ\text{C}$	0.1 A	2 A
Rated frequency (without derating)	50 / 60 Hz	
I_e / Rated operational current acc. to IEC 60947-5-1	AC-14 0.1 A	AC-15 2 A
	24-127 V 50/60 Hz	2 A
	220-240 V 50/60 Hz	2 A
Making capacity	6 x I_e AC-14 acc. to IEC 60947-5-1	10 x I_e AC-15 acc. to IEC 60947-5-1
Breaking capacity	6 x I_e AC-14 acc. to IEC 60947-5-1	10 x I_e AC-15 acc. to IEC 60947-5-1
I_e / Rated operational current DC-12 acc. to IEC 60947-5-1	24 V DC 0.1 A	2 A
	48 V DC 0.1 A	1 A
	72 V DC 0.1 A	0.3 A
	110 V DC 0.1 A	0.2 A
	125 V DC –	0.2 A
	220 V DC –	0.1 A
Short-circuit protection device FF type fuse (1)	0.1 A	10 A
Minimum switching capacity		
AF09 ... AF38 contactors with failure rate acc. to IEC 60947-5-4	3 V / 1 mA	17 V / 1 mA
	–	$\leq 10^{-7}$
Mechanical durability		
Number of operating cycles	5 millions for CE5-..D0.1	5 millions for CE5-..D2
	2.5 millions for CE5-..W0.1	2.5 millions for CE5-..W2
Max. switching frequency	3600 cycles/h	
Electrical durability		
Number of operating cycles	2.5 millions for CE5-..D0.1	1 million for CE5-..D2
	0.7 millions for CE5-..W0.1	0.3 millions for CE5-..W2
Max. electrical switching frequency		
	AC-14 1200 cycles/h	
	AC-15 1200 cycles/h	
	DC-12 900 cycles/h	

Contact utilization characteristics according to UL / CSA

Standards	UL 508, CSA C22.2 N°14	
Max. operational voltage	125 V AC / 110 V DC	250 V AC / 220 V DC
Pilot duty		
AC thermal rated current	0.1 A	2 A

Connecting characteristics

Connection capacity (min. ... max.)		
 Rigid solid	1 x	1...4 mm ²
	2 x	1...4 mm ²
 Flexible with ferrule	1 x	0.75...2.5 mm ²
	2 x	0.75...2.5 mm ²
 Lugs	L ≤	7.7 mm
	L >	3.7 mm
Connecting capacity acc. to UL / CSA	1 or 2 x	AWG 18...14
Tightening torque		1 Nm
Degree of protection	Terminals	IP20
acc. to IEC 60947-1 / EN 60947-1 and IEC 60529 / EN 60529	Microswitches	IP40 for CE5-..D0.1 IP67 for CE5-..W0.1
		IP40 for CE5-..D2 IP67 for CE5-..W2
Screw terminals		Delivered in open position, screws of unused terminals must be tightened
All terminals		M3.5
Screwdriver type		Flat Ø 5.5 / Pozidriv 2

(1) HRC fuses for very fast action (6.3 x 32 mm size).

Auxiliary contact blocks for severe industrial environments

For AF contactors

Main accessory fitting details

Many configurations of accessories are possible depending on whether these are front-mounted or side-mounted.

Contactor types	Main poles	Built-in auxiliary contacts	Front-mounted accessories			Electrical and mechanical interlock set (Between 2 contactors) VEM4	Side-mounted accessories	
			Auxiliary contact blocks		Auxiliary contact blocks		Left side	Right side
			1-pole CE5	1-pole CA4 1-pole CC4			2-pole CAL4-11	
3-pole contactors AF09 ... AF38								
			Max. N.C. built-in and add-on N.C. auxiliary contacts (CA4, CC4, CAL4, VEM4): 2 max. with 1 CE5, none with 2 CE5 on positions 1, 2, 3, 4					
AF09 ... AF16	3	0 0 1	1	+ 3 max.	-	+	1	-
AF09 ... AF16	3	0 1 0	2	+ 2 max.	-	-	-	-
AF26 ... AF38	3	0 0 0	1	+ 3 max.	-	+	1	-
			1	+ 1 max.	-	+	1	+ 1
			1	+ 2 max.	+ 1	-	1	-
			Max. N.C. built-in or add-on N.C. auxiliary contacts (CA4, CC4, CAL4, VEM4): 1 max. with 1 CE5 on positions 1 ±30°, 5					
AF09 ... AF16	3	0 0 1	1	+ 3 max.	-	-	-	-
AF09 ... AF16	3	0 1 0	1	+ 3 max.	-	+	1	-
AF26 ... AF38	3	0 0 0	1	+ 2 max.	+ 1	-	-	-
			Max. add-on N.C. auxiliary contacts (CA4, CC4, CAL4): 4 max. with 1 CE5, 2 max. with 2 CE5 on positions 1, 1 ±30°, 2, 3, 4, 5					
AF40 ... AF96	3	0 0 0	2	+ 2 max.	-	+	1	+ 1
			1	+ 3 max.	-	+	1	+ 1
4-pole contactors AF09 ... AF80								
			Max. add-on N.C. auxiliary contacts (CA4, CC4, CAL4, VEM4): 2 max. with 1 CE5, none with 2 CE5 on positions 1, 2, 3, 4					
AF09, AF16	4	0 0 0	2	+ 2 max.	-	-	-	-
			1	+ 3 max.	-	+	1	-
			1	+ 1 max.	-	+	1	+ 1
			1	+ 2 max.	+ 1	-	1	-
			Max. add-on N.C. auxiliary contacts (CA4, CC4, CAL4, VEM4): 1 max. with 1 CE5 on positions 1, 2, 3, 4					
AF26, AF38	4	0 0 0	1	+ 3 max.	-	+	1	-
			1	+ 2 max.	+ 1	-	-	-
AF09, AF16 AF26, AF38	2	2 0 0	1	+ 3 max.	-	+	1	-
			Max. add-on N.C. auxiliary contacts (CA4, CC4, CAL4, VEM4): 1 max. with 1 CE5 on positions 1 ±30°, 5					
AF09, AF16	4	0 0 0	1	+ 3 max.	-	+	1	-
			1	+ 2 max.	+ 1	-	-	-
			No add-on N.C. auxiliary contacts on positions 1 ±30°, 5					
AF26, AF38 AF09, AF16 AF26, AF38	4	0 0 0	1	+ 3 max.	-	-	-	-
			Max. add-on N.C. auxiliary contacts (CA4, CC4, CAL4): 4 max. with 1 CE5, 2 max. with 2 CE5 on positions 1, 1 ±30°, 2, 3, 4, 5					
AF40 ... AF80	4	0 0 0	2	+ 2 max.	-	+	1	+ 1
			1	+ 3 max.	-	+	1	+ 1
			No add-on N.C. auxiliary contacts on positions 1, 1 ±30°, 2, 3, 4, 5					
AF40, AF80	2	2 0 0	1	+ 3 max.	-	-	-	-

Auxiliary contact blocks for severe industrial environments

For NF contactor relays

Main accessory fitting details

Many configurations of accessories are possible depending on whether these are front-mounted or side-mounted.

Contactor relay types	Main poles 	E E	Front-mounted accessories Auxiliary contact blocks			Side-mounted accessories Auxiliary contact blocks				
			1-pole CE5	1-pole CA4 1-pole CC4		Left side 2-pole CAL4-11	Right side			
NF	2 2 3 1	E E	1	+	3 max.	-	+	1	-	
Max. add-on N.C. auxiliary contacts (CA4, CC4, CAL4): 1 max. with 1 CE5 on positions 1, 2, 3, 4										
NF	4 0	E	2	+	2 max.	-	-	-	-	
			1	+	3 max.	-	+	1	-	
			1	+	1 max.	-	+	1	+	1
Max. add-on N.C. auxiliary contacts (CA4, CC4, CAL4): 2 max. with 1 CE5, none with 2 CE5 on positions 1, 2, 3, 4										
NF	2 2 3 1	E E	1	+	3 max.	-	-	-	-	
Max. add-on N.C. auxiliary contacts (CA4, CC4): none with 1 CE5 on positions 1 ±30°, 5										
NF	4 0	E	1	+	3 max.	-	+	1	-	
Max. add-on N.C. auxiliary contacts (CA4, CC4, CAL4): 1 max. with 1 CE5 on positions 1 ±30°, 5										

Auxiliary contact blocks for AF116 ... AF2650 contactors



CAL19-11

1SFN01071V0001

Description

The auxiliary contact blocks are used for the operation of auxiliary circuits and control circuits for standard industrial environments.

Types of auxiliary contact blocks for side mounting:

- CAL 2-pole block, with instantaneous N.O. + N.C. contacts.

For clipping onto the right- and/or left-hand side of the contactors.

The CAL ...-11B is a second block for mounting in addition to a first CAL ...-11 block, right- and/or left-hand of the AF116 ... AF2650 contactors.

The auxiliary contact blocks are equipped with screw type connecting terminals delivered open, protected against accidental direct contact and bear the corresponding function marking.

Ordering details (1)

For contactors	Auxiliary contacts	Type	Order code	Pkg qty	Weight (1 pce)
					kg

Side-mounted instantaneous auxiliary contact blocks

AF116 ... AF370	1	1	CAL19-11	1SFN010820R1011	2	0.040
	1	1	CAL19-11B	1SFN010820R3311	2	0.040
AF400 ... AF2650	1	1	CAL18-11	1SFN010720R1011	2	0.050
	1	1	CAL18-11B	1SFN010720R3311	2	0.050

(1) For each contactor type, refer to "Accessory fitting details" table.



CAL18-11

1SFN01082V0001

Auxiliary contact blocks for AF116 ... AF2650 contactors

Technical data

Types	CAL18	CAL19
-------	-------	-------





Contact utilization characteristics according to IEC

Standards	IEC 60947-5-1 and EN 60947-5-1		
Rated insulation voltage U_i acc. to IEC 60947-5-1	690 V		
Rated impulse withstand voltage U_{imp}	6 kV		
Rated operational voltage U_e max.	24...690 V AC		
Conventional thermal current I_{th} - $\theta \leq 40$ °C	16 A		
Rated frequency (without derating)	50/60 Hz		
I_e / Rated operational current AC-15 acc. to IEC 60947-5-1	24-127 V 50/60 Hz	6 A	
	220-240 V 50/60 Hz	4 A	
	380-440 V 50/60 Hz	3 A	
	500-690 V 50/60 Hz	2 A	
	Making capacity acc. to IEC 60947-5-1	10 x I_e AC-15	
Breaking capacity acc. to IEC 60947-5-1	10 x I_e AC-15		
I_e / Rated operational current DC-13 acc. to IEC 60947-5-1	24 V DC	6 A / 144 W	3 A / 72 W
	48 V DC	2.8 A / 134 W	1.5 A / 72 W
	72 V DC	1 A / 72 W	1 A / 72 W
	110 V DC	0.55 A / 60 W	0.55 A / 60 W
	125 V DC	0.55 A / 69 W	0.55 A / 69 W
	220 V DC	0.3 A / 66 W	0.3 A / 69 W
	250 V DC	0.3 A / 75 W	0.3 A / 75 W
Short-circuit protection device gG type fuse	10 A		
Rated short-time withstand current I_{sc} $\theta = 40$ °C	for 1.0 s	100 A	
	for 0.1 s	140 A	
Minimum switching capacity with failure rate acc. to IEC 60947-5-4	24 V / 50 mA (0.5 million of operating cycles)		24 V / 50 mA
Power dissipation per pole at 6 A	0.15 W		
Mechanical durability	Number of operating cycles	3 millions (A/AF400 ... AF750)	
	Max. switching frequency	0.5 million (AF1250 ... AF2050)	5 millions operating cycles
Max. electrical switching frequency	AC-15	3600 cycles/h	300 cycles/h
	DC-13	1200 cycles/h	300 cycles/h
Mirror contacts acc. to annex F of IEC 60947-4-1	900 cycles/h		300 cycles/h
Mirror contacts acc. to annex F of IEC 60947-4-1	N.C. auxiliary contacts are mirror contacts		

Contact utilization characteristics according to UL / CSA

Standards	UL 508, CSA C22.2 N°14
Max. operational voltage	600 V AC, 250 V DC
Pilot duty	A600, Q300
AC thermal rated current	10 A
AC maximum volt-ampere making	7200 V A
AC maximum volt-ampere breaking	720 V A
DC thermal rated current	2.5 A
DC maximum volt-ampere making-breaking	69 V A

Connecting characteristics

Connection capacity (min. ... max.)	
 Solid / stranded	1 x 1...4 mm ² 2 x 1...4 mm ²
 Flexible with non insulated ferrule	1 x 0.75...2.5 mm ² 2 x 0.75...2.5 mm ²
 Flexible with insulated ferrule	1 x 0.75...2.5 mm ² 2 x 0.75...2.5 mm ²
 Lugs	L ≤ 8 mm I > 3.7 mm
Connection capacity acc. to UL/CSA	1 or 2 x AWG18...14
Stripping length	9 mm
Tightening torque	1 Nm
Degree of protection acc. to IEC 60947-1 / EN 60947-1 and IEC 60529 / EN 60529	IP20
Screw terminals All terminals	Delivered in open position, screws of unused terminals must be tightened M3.5
Screwdriver type	Flat Ø 5.5 / Pozidriv 2

Auxiliary contact blocks for AF116 ... AF2650 contactors for severe industrial environments



CEL19

1SFC10121AV0001



CEL18

1SFC101083V0001

Description

The auxiliary contact blocks are used for the operation of auxiliary and control circuits for severe industrial environments.



Types of auxiliary contact blocks for side mounting:

- CEL 1-pole block, with built-in microswitch IP67 degree of protection (IP20 on terminals). Instantaneous N.O. or N.C. contact.

For clipping onto the right- and/or left-hand side of the contactors.

The auxiliary contact blocks are equipped with screw type connecting terminals delivered open, protected against accidental direct contact and bear the corresponding function marking.

Ordering details (1)

For contactors	Auxiliary contacts		Type	Order code	Pkg qty	Weight (1 pce)
						kg
Side-mounting instantaneous auxiliary contact blocks						
AF116 ... AF370	1	0	CEL19-10	1SFN010832R1010	1	0.040
	0	1	CEL19-01	1SFN010832R1001	1	0.040
AF400 ... AF2650	1	0	CEL18-10	1SFN010716R1010	1	0.050
	0	1	CEL18-01	1SFN010716R1001	1	0.050

(1) For each contactor type, refer to "Accessory fitting details" table.

Auxiliary contact blocks for AF116 ... AF2650 contactors for severe industrial environments

Technical data

Types	CEL18, CEL19
-------	--------------



Contact utilization characteristics according to IEC

Standards	IEC 60947-5-1 and EN 60947-5-1		
Rated insulation voltage U_i acc. to IEC 60947-5-1	250 V		
Rated operational voltage U_e max.	125 V		
Conventional thermal current I_{th} - $\theta \leq 40^\circ\text{C}$	0.1 A		
I_e / Rated operational current AC-14	24-127 V 50/60 Hz	0.1 A	
acc. to IEC 60947-5-1			
Making capacity acc. to IEC 60947-5-1	6 x I_e AC-14		
Breaking capacity acc. to IEC 60947-5-1	6 x I_e AC-14		
I_e / Rated operational current DC-12	24 V DC 48 V DC 72 V DC 110 V DC 220 V DC	0.1 A	
acc. to IEC 60947-5-1			
		0.1 A	
		0.1 A	
		0.1 A	
		-	
Short-circuit protection device	0.1 A (FF type fuses) (1)		
Minimum switching capacity	3 V / 1 mA		
with failure rate acc. to IEC 60947-5-4			
Mechanical durability	Number of operating cycles	1 million (2)	
		Max. switching frequency	1200 cycles/h (2)
Electrical durability	Number of operating cycles	0.7 millions (2)	
		Max. switching frequency	AC-14, AC15 1200 cycles/h (2)
			DC-12 900 cycles/h (2)
Mirror contacts acc. to annex F of IEC 60947-4-1	N.C. auxiliary contacts are mirror contacts		

Contact utilization characteristics according to UL / CSA

Standards	UL 508, CSA C22.2 N°14
Max. operational voltage	125 V
Pilot duty	
AC thermal rated current	0.1 A

Connecting characteristics

Connection capacity (min. ... max.)		
 Rigid solid	1 x	1...4 mm ²
	2 x	1...4 mm ²
 Flexible with ferrule	1 x	0.75...2.5 mm ²
	2 x	0.75...2.5 mm ²
 Lugs	L ≤	7.7 mm
	L >	3.7 mm
Connection capacity acc. to UL/CSA	1 or 2 x	AWG 18...14
Tightening torque		1 Nm
Degree of protection	Terminals	IP20
acc. to IEC 60947-1 / EN 60947-1 and IEC 60529 / EN 60529	Microswitches	IP67
Screw terminals	Delivered in open position, screws of unused terminals must be tightened	
All terminals	M3.5	
Screwdriver type	Flat Ø 5.5 / Pozidriv 2	

(1) or HRC fuses for very fast action (6.3 x 32 mm size).

(2) For CEL19, please consult us.

Auxiliary contact blocks for AF09 ... AF96 contactors and NF contactor relays

Electrical durability

Electrical durability for AC-15 utilization category

AC-15 utilization category according to IEC 60947-5-1 / EN 60947-5-1:

- making current: $10 \times I_e$ with $\cos \varphi = 0.7$ and U_e
- breaking current: I_e with $\cos \varphi = 0.4$ and U_e .

These curves represent the electrical durability of the built-in or add-on auxiliary contacts in relation to the breaking current. The curves have been drawn for resistive and inductive loads up to 690 V, 40...60 Hz.

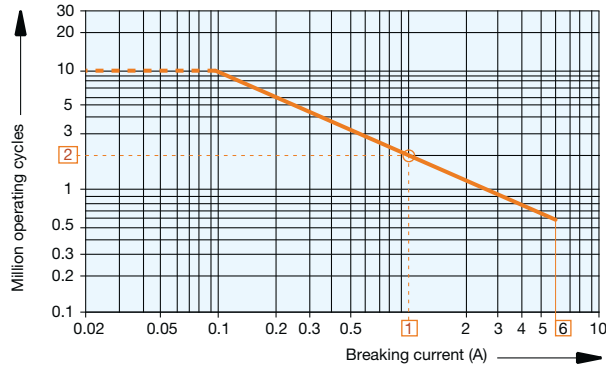

- AF09 ... AF96 contactor built-in auxiliary contacts
- 1-pole and 4-pole CA4, 2-pole CAT4, 1-pole CC4, 2-pole CAL4 add-on auxiliary contacts.

Example:

Breaking current = 1 A

On the opposite curve at intersection "O" 1 A the corresponding value for the electrical durability is approximately 2 millions operating cycles.

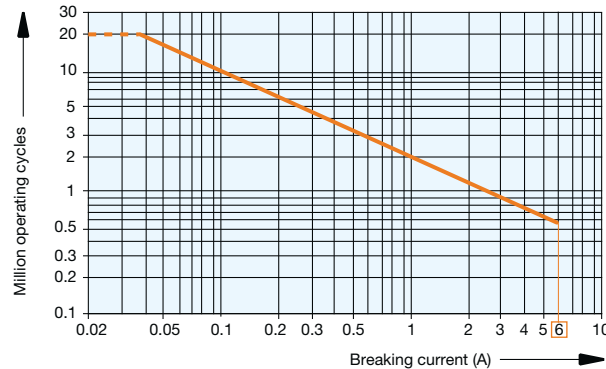

NF contactor relays.

(For add on auxiliary contacts see curve above).

Electrical durability for DC-13 utilization category

DC-13 utilization category according to IEC 60947-5-1 / EN 60947-5-1: making and breaking current I_e and U_e .

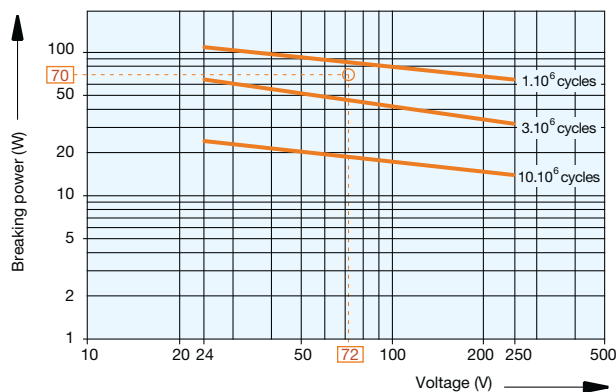

- AF09 ... AF96 contactor built-in auxiliary contacts 1-pole and 4-pole CA4, 2-pole CAT4, 1-pole CC4,
- 2-pole CAL4 add-on auxiliary contacts,
- NF contactor relays.

Example:

Control of DC electro-magnet:

U_e voltage = 72 V DC and breaking power = 70 W.

On the opposite curve at intersection "O" 72 V / 70 W the corresponding value for the electrical durability is approximately 2 millions operating cycles.

Auxiliary contact blocks for AF116 ... AF2650 contactors

Electrical durability

Electrical durability for AC-15 utilization category

AC-15 utilization category according to IEC 60947-5-1 / EN 60947-5-1:

- making current: $10 \times I_e$ with $\cos \varphi = 0.7$ and U_e
- breaking current: I_e with $\cos \varphi = 0.4$ and U_e .

These curves represent the electrical durability of the add-on auxiliary contacts, in relation to the breaking current.

The curves have been drawn for resistive and inductive loads up to 690 V, 40...60 Hz.

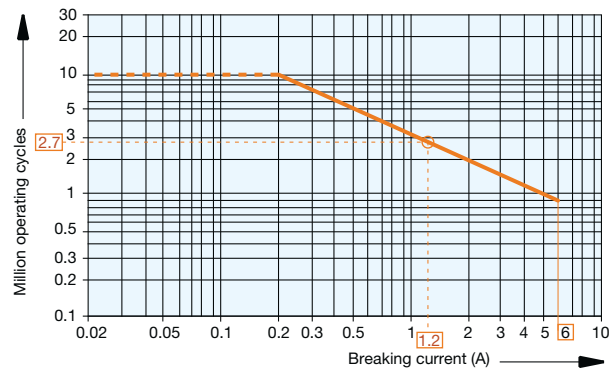

- AF116 ... AF2650 contactors auxiliary contacts
- 2-pole CAL18 and CAL19 add-on auxiliary contacts

Example:

Breaking current = 1.2 A

On the opposite curve at intersection "O" 1.2 A the corresponding value for the electrical durability is approximately 2.7 millions operating cycles.

Add-on auxiliary contacts

Terminal marking and positioning

1-pole auxiliary contacts

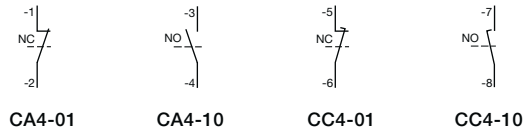

2-pole auxiliary contacts

5

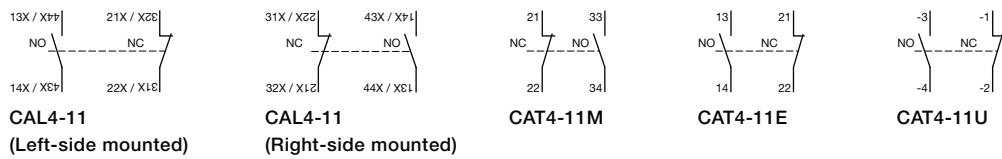

4-pole auxiliary contacts

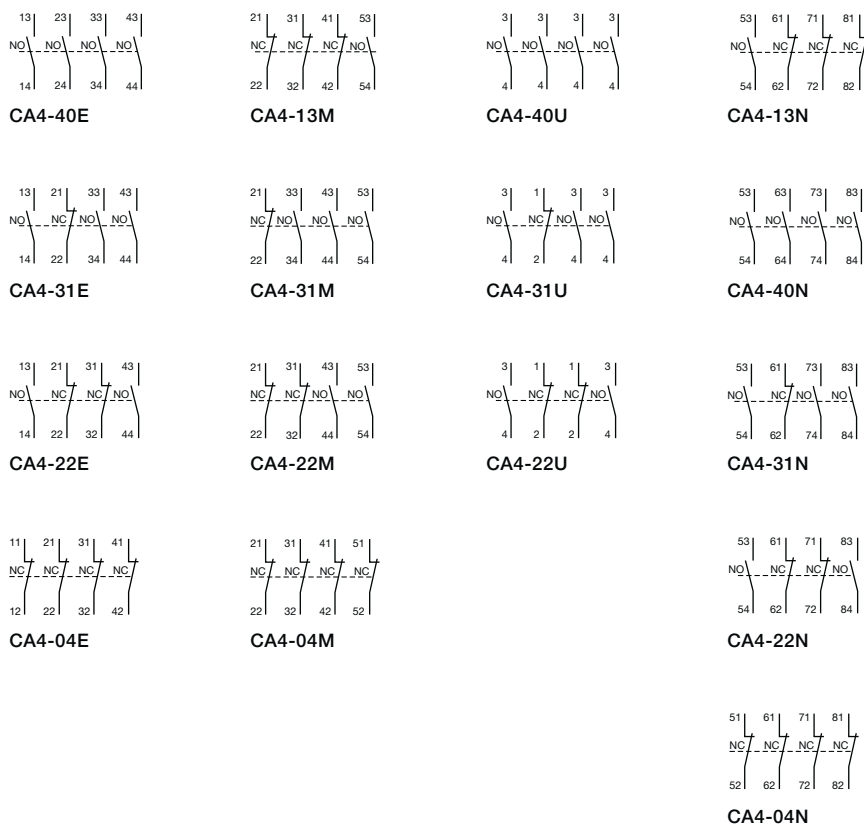

Electronic timers



TEF4-ON

1SBC1000AV0014



TEF4-OFF

1SBC1000I2V0014

Description

TEF4 frontal electronic timers are used for realizing timing function and are available in ON-delay and OFF-delay versions.

Compact solution in cabinet compared to separate timers

TEF4 electronic timers are front-mounted and locked on AF contactors or NF contactor relays. A mechanical indicator allows to show the state of the contactor.

Safe and cost-reduced wiring

TEF4 electronic timers are supplied by a direct plug-in parallel connection to the coil terminals A1 - A2 of the contactor or contactor relay. A varistor is integrated on the timer to offer a built-in protection against surges in the contactor coil.

Available for a wide control voltage range 24...240 V AC/DC

TEF4-ON or TEF4-OFF allow time-delayed functions up to 100 s in 3 distinct time ranges, independently of the control system. The time delay ranges are selected by a switch and the time delay can be adjusted by means of a rotary switch. The timing function is activated by closing or opening the device on which the timer is mounted. The OFF-delay version operates without additional control supply.

Ordering details

For contactors, contactor relays	Time delay range selected by switch	Delay type	Rated control circuit voltage U _c V 50/60 Hz or DC	Auxiliary contacts 	Type	Order code	Weight Pkg (1 pce) kg
AF09 ... AF96	0.1...1 s	ON-delay	24...240	1 1	TEF4-ON	1SBN020112R1000	0.065
NF	1...10 s 10...100 s	OFF-delay	24...240	1 1	TEF4-OFF	1SBN020114R1000	0.065

Electronic timers

Technical data

Contact utilization characteristics according to IEC

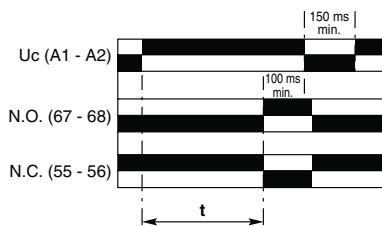
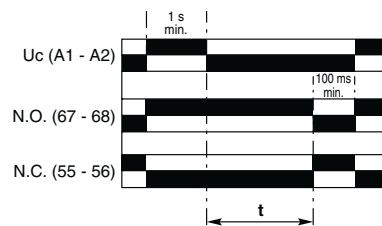
Types	TEF4-ON	TEF4-OFF
Standards	IEC 60947-5-1 and EN 60947-5-1	
Rated insulation voltage U_i acc. to IEC 60947-5-1	400 V	
Rated impulse withstand voltage U_{imp}	4 kV	
Rated operational voltage U_e max.	240 V	
Rated frequency (without derating)	50 / 60 Hz	
Conventional thermal current $I_{th} - \theta \leq 40^\circ\text{C}$	5 A	
I_e / Rated operational current AC-15 acc. to IEC 60947-5-1	24-127 V 50/60 Hz 220-240 V 50/60 Hz	3 A 1.5 A
Making capacity acc. to IEC 60947-5-1	10 x I_e AC-15	
Breaking capacity acc. to IEC 60947-5-1	10 x I_e AC-15	
I_e / Rated operational current DC-13 acc. to IEC 60947-5-1	24 V DC	1 A / 24 W
Short-circuit protection device gG type fuse	6 A	
Rated short-time withstand current I_{cw} $\theta = 40^\circ\text{C}$	for 1.0 s for 0.1 s	8 A 8 A
Minimum switching capacity with failure rate acc. to IEC 60947-5-4	24 V DC	12 V / 3 mA 10^{-7}
Power dissipation per pole at 3 A	0.1 W	
Function diagram	ON-delay 	OFF-delay 
	Bistable relay inside. Before use, once apply U_c then switch it off in order to initialize position of the contacts.	
Control circuit voltage		
AC control voltage	Rated control circuit voltage U_c 50/60 Hz	24...240 V AC 1.5 mA RMS
DC control voltage	Rated control circuit voltage U_c Average consumption	24...240 V DC 1.5 mA 1 mA
Rated frequency limits	50 / 60 Hz	
Supply voltage range	0.85...1.1 x U_c (at $\theta \leq 70^\circ\text{C}$)	
Overvoltage protection	Varistor included	
Time delay range (t) selected by switch	0.1...1 s 1...10 s 10...100 s	<input type="checkbox"/> <input type="checkbox"/> <input type="checkbox"/>
On-load reiteration accuracy under constant conditions	$\leq 1\%$	
Minimum ON period	0.1 s	
Recovery time	0.15 s	
Ambient air temperature	Operation Storage	-25 °C ... +70 °C -40 °C ... +80 °C
Climatic withstand	Category B according to IEC 60947-1 Annex Q	
Maximum operating altitude	2000 m	
Mounting positions	Mounting positions 1, 1 +/- 30°, 2, 3, 4, 5	
Shock withstand acc. to IEC 60068-2-27 and EN 60068-2-27 (Mounting position 1)	1/2 sinusoidal shock for 11 ms: no change in contact position Same as contactor or contactor relay	
Vibration withstand acc. to IEC 60068-2-6	5...300 Hz 3 g closed position / 2 g open position	
Mechanical durability	Number of operating cycles Max. switching frequency	5 millions operating cycles 3600 cycles/h 1800 cycles/h
Max. electrical switching frequency	AC-15 DC-13	1200 cycles/h 900 cycles/h





Electronic timers

Technical data

Contact utilization characteristics according to UL / CSA

Types	TEF4-ON	TEF4-OFF
Standards	UL 508, CSA C22.2 N°14	
Rated insulation voltage U_i acc. to UL / CSA	300 V	
Max. operational voltage	240 V	
Pilot duty	B300, R300	
AC thermal rated current	5 A	
AC maximum volt-ampere making	3600 VA	
AC maximum volt-ampere breaking	360 VA	
DC thermal rated current	1 A	
DC maximum volt-ampere making-breaking	28 VA	

Connecting characteristics

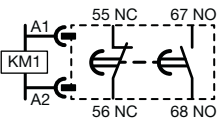
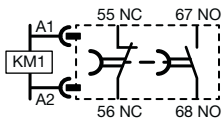
Connection capacity (min. ... max.)		
 Rigid solid	1 x	1...2.5 mm ²
	2 x	1...2.5 mm ²
 Flexible with non insulated ferrule	1 x	0.75...2.5 mm ²
	2 x	0.75...2.5 mm ²
 Flexible with insulated ferrule	1 x	0.75...2.5 mm ²
	2 x	0.75...1.5 mm ²
 Lugs	L ≤	8 mm
	I >	3.7 mm
Connection capacity acc. to UL / CSA	1 or 2 x	AWG 18...14
Stripping length		10 mm
Tightening torque		1.2 N.m / 11 lb.in
Degree of protection acc. to IEC 60947-1 / EN 60947-1 and IEC 60529 / EN 60529		IP20
Screw terminals		Delivered in open position, screws of unused terminals should be tightened
All terminals		M3.5
Screwdriver type		Flat Ø 5.5 / Pozidriv 2
Terminal Marking		 

5

Electrical durability for DC-13 utilization category

DC-13 utilization category according to IEC 60947-5-1 / EN 60947-5-1: making and breaking current I_e and U_e .

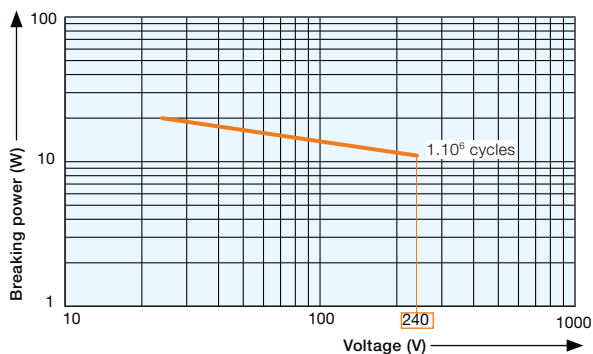

Interlocks



VM4

1SBC100010V0014

Mechanical interlock units

Description

The VM mechanical interlock units are designed for the interlocking of two AF contactors. When mounted between two contactors, the VM mechanical interlock unit prevents one of the contactors from closing as long as the other contactor is closed. The mechanical interlock units VM4 and VM96-4 include 2 fixing clips (BB4).

Ordering details

For contactors	Mounting	Type	Order code	Pkg qty	Weight (1 pce) kg
Mechanical interlock units for two contactors mounted side by side					
AF09 ... AF38..-30-..		VM4	1SBN030105T1000	10	0.005
AF09 ... AF38..-40-00					
AF40 ... AF96-30-..		VM96-4	1SBN033405T1000	10	0.006
AF40 ... AF80-40-00					
For same size contactors:		VM19	1SFN030300R1000	1	0.054
AF116 ... AF146					
AF190, AF205					
AF265 ... AF370					
AF116 ... AF146 and AF190, AF205		VM140/190	1SFN034403R1000	1	0.088
AF190, AF205 and AF265 ... AF370		VM205/265	1SFN035203R1000	1	0.090
AF400 ... AF1250	PN.. mounting plate to be ordered separately	VM750H	1SFN035700R1000	1	0.200
AF1350 ... AF2650	Plate included	VM1650H	1SFN036503R1001	1	6.000
Mechanical interlock units for two contactors mounted one above the other					
AF400 ... AF1250	Additional plate (not supplied)	VM750V	1SFN035701R1000	1	0.200

5

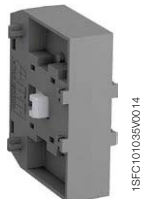

VM19

1SFC101035M0014

Mechanical and electrical interlock sets

Description

VEM4 mechanical and electrical interlock set for the interlocking of two AF contactors. VEM4 set includes a mechanical interlock unit VM4 with 2 fixing clips (BB4) and a VE4 electrical interlock block with A2-A2 connection. Fixing the electrical interlock block to the contactor front face connects the 2 built-in N.C. interlocking contacts with the two coils. VE4 block must be used with A2-A2 connection to respect the electrical connection diagram.

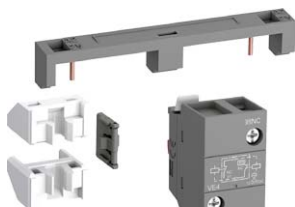

VEM4

1SBC100011V0014

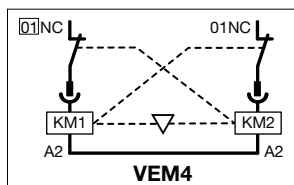

Ordering details

For contactors	Auxiliary contacts	Type	Order code	Pkg qty	Weight (1 pce) kg
Mechanical and electrical interlock set					
For same size contactors:	0 2	VEM4	1SBN030111R1000	1	0.035
AF09 ... AF16..-30-..					
AF26 ... AF38..-30-00					
AF09, AF16..-40-00					
AF26, AF38..-40-00					

Fixing clips

AF09 ... AF96	BB4	1SBN110120W1000	50	0.002
---------------	-----	-----------------	----	-------

Note: VEM4 not suitable for AF.Z contactors with DC control voltage 12...20 V DC.



BB4

1SBC100013V0014

Interlocks

Technical data

Mechanical interlock unit

Types	VM4, VM96	VM19 ... VM750	VM1650H
Mechanical durability	Number of operating cycles	5 millions operating cycles	1 million operating cycles
	Max. mechanical switching frequency	1800 cycles/h	300 cycles/h

Mechanical and electrical interlock set







Contact utilization characteristics according to IEC

Types	VEM4	
Standards	IEC 60947-5-1 and EN 60947-5-1	
Rated insulation voltage U_i acc. to IEC 60947-5-1	690 V	
Rated impulse withstand voltage U_{imp} .	6 kV	
Rated control circuit voltage U_c	AC 50/60 Hz control voltage	24...500 V AC
	DC control voltage	20...500 V DC
Conventional thermal current $I_{th} - \theta \leq 40 \text{ °C}$	16 A	
Mechanical durability	Number of operating cycles	5 millions operating cycles
	Max. mechanical switching frequency	1800 cycles/h
Electrical durability	Max. electrical switching frequency	1200 cycles/h

Contact utilization characteristics according to UL / CSA

Types	VEM4
Standards	UL 508, CSA C22.2 N°14
Max. operational voltage	500 V AC, 500 V DC

Connecting characteristics

Types	VEM4
Connection capacity (min. ... max.)	
 Rigid solid	1 x 1...2.5 mm ²
 Rigid solid	2 x 1...2.5 mm ²
 Flexible with ferrule	1 x 0.75...2.5 mm ²
 Flexible with ferrule	2 x 0.75...2.5 mm ²
 Flexible with insulated ferrule	1 x 0.75...2.5 mm ²
 Flexible with insulated ferrule	2 x 0.75...1.5 mm ²
 Lugs	L < 8 mm
Connection capacity acc. to UL / CSA	1 or 2 x AWG 18...14
Stripping length	10 mm
Tightening torque	1.2 Nm / 11 lb.in
Degree of protection	IP20
acc. to IEC 60947-1 / EN 60947-1 and IEC 60529 / EN 60529	
Screw terminals	Delivered in open position, screws of unused terminals must be tightened
All terminals	M3.5
Screwdriver type	Flat Ø 5.5 / Pozidriv 2

Impulse contact blocks



CB5

Description

Impulse contact blocks are designed for use in enclosures, in association with an adjustable mechanical pushbutton. Two types are available:

- CB5-10: N.O. contact with a black actuator ("ON" function)
- CB5-01: N.C. contact with a light grey actuator ("OFF" function).

These blocks are equipped with 2 connecting leads 0.5 mm² with end, approximately 18 cm long.

Mounting: Clipped onto the front face of the contactors.

Ordering details

For contactors	Contacts	Type	Order code	Pkg qty	Weight (1 pce) kg
AF09 ... AF96	1 -	CB5-10	1SBN010013R1010	1	0.012
	- 1	CB5-01	1SBN010013R1001	1	0.012

Main dimensions mm, inches

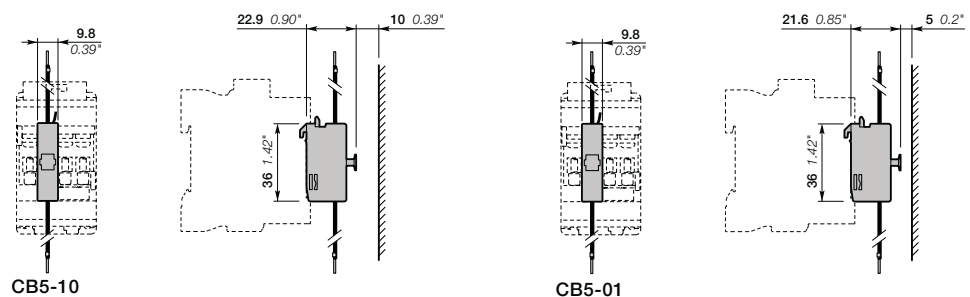

Notes

A series of horizontal dotted lines for writing notes, spanning the width of the page.

RA4 interface relays



RA4

1SBC101065V0014

Description

RA4 interface relay is designed to receive 24 V DC signals delivered by PLC's or other sources with a low output power and to restore them with sufficient power to operate the coils of the relevant AF09 ... AF96 contactors or the NF contactor relays. RA4 interface relay is made up of a miniature electromechanical relay equipped with a N.O. contact and with a low consumption 24 V DC coil.

The interface relay coil is controlled by the PLC while the N.O. contact ensures switching of the power contactor.

Coil switching gives rise to overvoltages which have adverse effects on the electronic devices, insulators and, more generally, on component lifetime. The RA4 is protected from surge thanks to the built-in surge protection of AF09 ... AF96. Furthermore, the RA4 is protected against relay pole reversal by a diode inserted between the E1 and E2 input terminals.

Connection

The "E1+" and "E2-" input terminals must be connected, according to their polarity, to the PLC output. The RA4 is equipped with two terminal pads for connection to the A1 and A2 terminals of the contactor coil.

This coil is supplied between the A0 and A2 terminals of the RA4.

Mounting

Remove the coil terminal block from the contactor and clip the interface relay without any screwing operation.

Ordering details

For contactors (1)	Coil voltages (2)	Rated control circuit voltage Uc	Type	Order code	Pkg qty	Weight (1 pce)
	V AC 50/60 Hz	V DC				kg
AF09 ... AF96	24 ... 250	24	RA4	1SBN060100R1000	1	0.040
NF			RA4-T (3)	1SBN060100T1000	10	0.040

(1) LDC4 additional terminal blocks and CAT4 auxiliary contact blocks not suitable with RA4.

(2) Main use with contactor coils 41, 11, 12, 13.

(3) On request. Please contact your ABB local sales organization

Wiring diagram

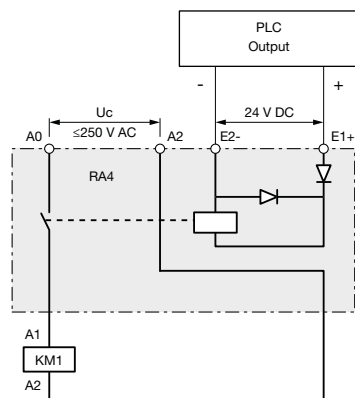

Main dimensions mm, inches

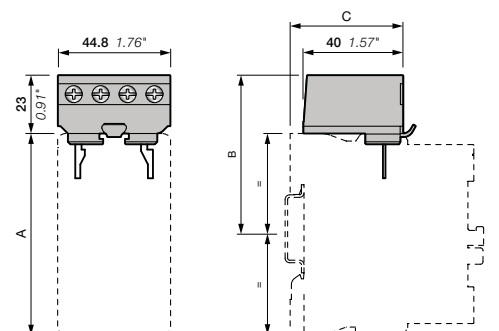

RA4 mounted on	AF09 ... AF38	AF40 ... AF96
A	80 mm / 3.15"	119.5 mm / 4.70"
B	63 mm / 2.48"	83 mm / 3.27"
C	45 mm / 1.77"	40 mm / 1.57"

1SBC101060S0201





RA4 interface relays

Technical data

Utilization characteristics according to IEC

Type	RA4
Standards	IEC 60947 5-1
Rated insulation voltage U_i acc. to IEC 60947 5-1	250 V AC 50/60 Hz
Ambient air temperature	
In free air operation	at $U_c = 24$ V DC (between E1 and E2) -25 ... +70 °C
Storage	from 0.85 to 1.1 x U_c -25 ... +60 °C -40 ... +70 °C
Climatic withstand	Category B according to IEC 60947-1 Annex Q
Maximum operating altitude	≤3000 m
Mounting positions	Mounting positions 1, 1 ±30°, 2, 3, 4, 5

Connecting characteristics

Connection capacity (min. ... max.)		
 Rigid solid	1 x	1 ... 2.5 mm ²
	2 x	1 ... 2.5 mm ²
 Flexible with non insulated ferrule	1 x	0.75 ... 2.5 mm ²
	2 x	0.75 ... 2.5 mm ²
 Flexible with insulated ferrule	1 x	0.75 ... 2.5 mm ²
	2 x	0.75 ... 1.5 mm ²
 Lugs	L <	8 mm
Connection capacity acc. to UL/CSA	1 or 2 x	AWG 18 ... 14
Stripping length		10 mm
Tightening torque		1.2 Nm / 11 lb.in
Degree of protection		IP20 protection against direct contact in acc. with EN 50274
acc. to IEC 60947-1 / EN 60947-1 and IEC 60529 / EN 60529		RA4 wired and mounted on the associated contactor
Screw terminals		Delivered in open position
All terminals		M3.5
Screwdriver type		Flat Ø 5.5 / Pozidriv 2

Working data

Surge suppression		Included inside AF built-in surge protection
For interface relay coil		
Protection against polarity reversal between terminals E1 and E2		Diode
Interface relay operating time		Closing and drop-out ≤10 ms
Total operating time		
interface relay + contactor (1)		
Between energization and:	N.O. contact closing	42 ... 95 ms (AF09 ... AF38, NF) 44 ... 105 ms (AF40 ... AF96)
	N.C. contact opening	40 ... 90 ms (AF09 ... AF38, NF) 40 ... 100 ms (AF40 ... AF96)
Between de-energization and:	N.O. contact opening	15 ... 57 ms (AF09 ... AF38, NF) 21 ... 107 ms (AF40 ... AF96)
	N.C. contact closing	17 ... 60 ms (AF09 ... AF38, NF) 23 ... 112 ms (AF40 ... AF96)

(1) For contactor coils 41, 11, 12, 13.

Electrical input data

Control voltage (E1 and E2 terminals) U_c		
Rated value		24 V DC
Max. range at ambient temperature 20 °C		19 ... 30 V DC
Max. consumption for $U_c = 24$ V DC, $\theta = 20$ °C		0.3 W
"0" status (relay open)	for U_c	≤2.4 V DC
	for I_c	<1 mA
"1" status (relay closed)	for U_c	≥19 V DC
Max. short supply interruption immunity time		2 ms

Electrical output data

Switching voltage (A0 and A2 terminals)	≤250 V AC
Electrical durability	
Switching frequency	600 cycles/h
Number of operating cycles	2 million operating cycles

Mechanical latching units



1SBCT00040V0014

WB75-A

Description

For converting standard contactors into latched contactors.

The WB75-A block contains a mechanical latching device with electromagnetic impulse unlatching (AC or DC) or manual unlatching.

Captive screw type connecting terminals, built-in cable clamps, M3.5 (+,-) pozidriv 2 screw with screw-driver guidance; delivered untightened and protected against accidental direct contact.

Operation

After closing, the contactor continues to be held in the closed position by the latching mechanism should the supply voltage fail at the contactor coil terminals.

Contactor opening can be controlled:

- electrically by an impulse (AC or DC) on the WB75-A block coil.
(the coil is not designed to be permanently energized)
- manually by pressing the pushbutton on the front face of the WB75-A block.

Mounting

The WB75-A block is clipped onto the front face of the 1-stack contactor where it takes up two slots (see dimension drawing). The two other slots do not accept CA4 single pole auxiliary contacts. Up to 2 CAL4-11 auxiliary contact blocks can be side-mounted on contactors (except NF22E and AF.-22-00, refer to main accessory fitting details table in main accessories section).

Ordering details

For contactors	Rated control circuit voltage U _c		Type	Order code	Pkg qty	Weight (1 pce) kg
	V 50 Hz or DC	V 60 Hz				
AF09 ... AF65 NF	24	24...28	WB75-A	FPTN372726R1001	1	0.120
	42	42...48	WB75-A	FPTN372726R1002	1	0.120
	48	48...55	WB75-A	FPTN372726R1003	1	0.120
	110	110...127	WB75-A	FPTN372726R1004	1	0.120
	220...230	220...255	WB75-A	FPTN372726R1006	1	0.120
	230...240	230...277	WB75-A	FPTN372726R1005	1	0.120
	380...415	380...440	WB75-A	FPTN372726R1007	1	0.120
	415...440	440...480	WB75-A	FPTN372726R1008	1	0.120

Note: For WB75-A produced since week 06-2012.
WB75-A can not be used on AF80, AF96.

5

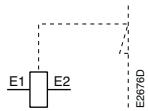

Terminal marking

Mechanical latching units



Technical data

Type	WB75-A
------	--------

Utilization characteristics according to IEC

Rated insulation voltage U_i acc. to IEC 60947-1	690 V
Max. electrical impulse time	
On AC coil (with load factor 5 %)	20 s
On DC coil (with load factor 3 %)	8 s
Min. electrical impulse time	
For latching (energizing of the contactor coil)	AC 120 ms DC 120 ms
For pull-out (energizing of the WB block coil)	AC 30 ms DC 50 ms
Coil operating limits	AC or DC supply 0.85...1.1 x U_c
AC control voltage 50/60 Hz	
Rated control circuit voltage U_c	24...480 V AC
Coil consumption	Average pull-in value 90 VA Average holding value 60 VA
DC control voltage	
Rated control circuit voltage U_c	24...440 V DC
Coil consumption	Average pull-in value 110 W Average holding value 110 W
Operating time	
On contactor closing (latching)	
Between coil energization and:	
N.O. contact closing	No difference with the operation of a contactor without mechanical latching unit
N.C. contact opening	No difference with the operation of a contactor without mechanical latching unit
On contactor opening (unlatching)	
Between WB coil energization and:	
N.O. contact opening	5...25 ms
N.C. contact closing	7...28 ms
Mechanical durability	Number of operating cycles 1 million operating cycles
Max. switching frequency	3600 cycles/h with on-load factor of 8 %

Connecting characteristics

Connection capacity (min. ... max.)	
 Rigid solid	1 x 1...4 mm ² 2 x 1...4 mm ²
 Flexible with ferrule	1 x 0.75...2.5 mm ² 2 x 0.75...2.5 mm ²
 Lugs	L < 8 mm I > 3.5 mm
Tightening torque	
Recommended	1 Nm
Max.	1.2 Nm
Screw terminals	Delivered in open position, screws of unused terminals must be tightened
All terminals	M3.5
Screwdriver type	Flat Ø 5.5 / Pozidriv 2

Other accessories



LDC4

1SBC10020V0014

Ordering details

For contactors	Type	Order code	Pkg qty	Weight (1 pce)
				kg



BX4

1SBC10021V0014

Additional coil terminal blocks

Additional coil terminal blocks for a bottom access to the coil terminals of contactors or contactor relays.

AF09 ... AF96, NF	LDC4	1SBN070156T1000	10	0.010
-------------------	------	-----------------	----	-------

Protective covers

Sealable and transparent protective covers BX4 and non-removable BX4-CA to protect the devices against accidental contact.

AF09 ... AF96 1-stack contactors and NF contactor relays	BX4	1SBN110108T1000	10	0.006
4-pole CA4, 2-pole CAT4 auxiliary contact blocks and TEF4 electronic timer	BX4-CA	1SBN110109W1000	50	0.001

Note: BX4 produced since 13045 (day 045 - year 2013) are suitable for AF40 ... AF96.

5



BX4-CA

1SECI00023V0014



BA4

1SNC160101F0014

Function markers AF09 ... AF370

Box of 16 blank cards (16 markers by card) printable on HTP500 thermal transfer printer and AMS 500 marking table to identify your contactors, overload relays or manual motor starters. Marker dimensions: 7 x 20 mm (.276" x .787").

AF09 ... AF370 contactors, TF thermal overload relays, EF electronic overload relays and MS116, MS132 manual motor starters	BA4	1SNA235156R2700	16	0.011
AMS 500 support plate for 8 BA4	SPRC 1	1SNA360010R1500	1	0.220
HTP500 support plate	HTP500-BA4	1SNA235712R2400	1	0.290

Function markers AF400 ... AF2650

Set of 50 function markers designed to be clipped onto the front face of devices. Details can be added to these markers using a ball point pen, indelible felt-tip pen or pentel white.

Self-adhesive labels (not supplied) can also be added to them.

Marker dimensions: 7 x 19 mm (.276" x .748").

AF400 ... AF2650 and accessories	BA5-50	1SBN110000R1000	1	0.017
----------------------------------	--------	-----------------	---	-------



BA5-50

1SBC100044V0014

Main dimensions mm, inches

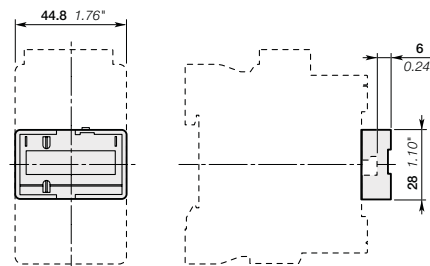

BX4

1SBC101733S0201

Other accessories



BP38-4



BDT4
For AF09 ... AF65, NF



BDT4
For AF80 ... AF96

Ordering details

For contactors	Type	Order code	Pkg qty	Weight (1 pce) kg
----------------	------	------------	---------	-------------------

Mounting pieces

Mounting piece for replacing installed contactors fixed by screws by AF contactors.

From contactor	To contactor	Type	Order code	Pkg qty	Weight (1 pce) kg
A26 ... A40, AL26 ... AL40	AF09 ... AF38	BP38-4	1SBN112303T1000	10	0.003
A40 ... A75, AE50 ... AE75, AF50 ... AF75	AF40 ... AF65	BP65-4	1SBN113403T1000	10	0.004
A95, A110, AE95, AE110, AF95, AF110	AF80 ... AF96	BP96-4	1SBN113903T1000	10	0.005

Test block

BDT4 test block is suitable for switching on contactor off-load.

Marking on the block indicates the contactor type to fit with.

AF09 ... AF96, NF	BDT4	1SBN110122T1000	10	0.007
-------------------	------	-----------------	----	-------

Main dimensions mm, inches

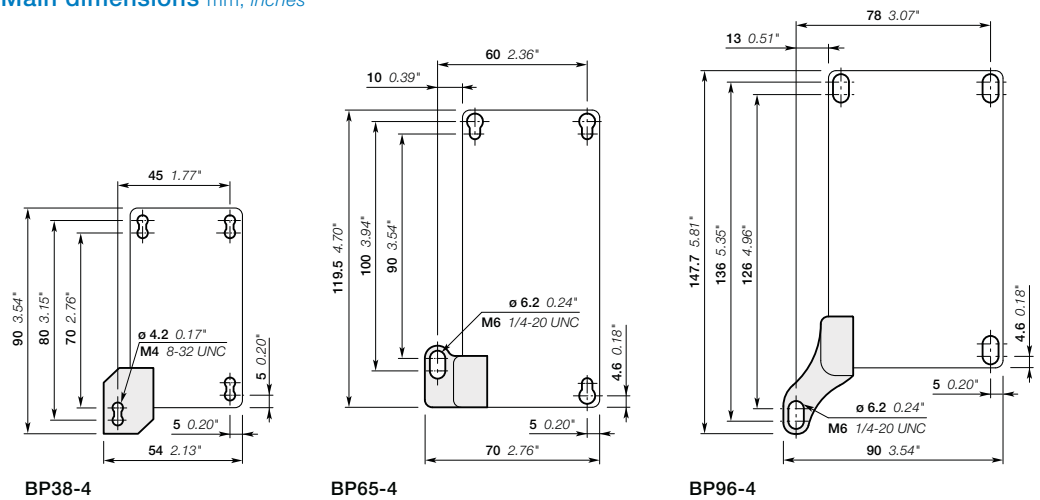

Additional terminal blocks



LD38-4

1SBC10734S0201





Description

The LD terminal block is designed to increase the connecting capacity of 3-pole AF26 ... AF38 contactors on which it is fitted and for preparation of the wiring before final connection to the contactor. LD38-4 blocks are 3-pole terminal blocks with tunnel terminals.

Ordering details

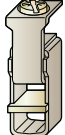
For contactors	Type	Order code	Pkg qty	Weight (1 pce)
AF26 ... AF38	LD38-4	1SBN072308R1000	2	0.070 kg

Technical data

Types	LD38-4
Rated insulation voltage Ui	
acc. to IEC 60947-4-1	690 V
acc. to UL / CSA	600 V
Main terminals	 <p>Screw terminals with double connector 2 x (7 width x 5.8/9.2 depth)</p>
Connection capacity (min. ... max.)	
 Rigid Solid ($\leq 4 \text{ mm}^2$) }  Rigid Stranded ($\geq 6 \text{ mm}^2$) }	1x 2.5...25 mm ²
 Flexible with non insulated ferrule	1x 2.5...16 mm ²
 Flexible with insulated ferrule	1x 2.5...16 mm ² + 1x 2.5...10 mm ²
Connection capacity acc. to UL / CSA	1x AWG 8-4 2x AWG 8-6
Stripping length	14 mm
Tightening torque	2.5 Nm / 22 lb.in
Degree of protection	
acc. to IEC 60947-1 / EN 60947-1 and IEC 60529 / EN 60529	IP20
Screw terminals	Delivered in closed position, screws of unused terminals must be tightened
Main terminals	M5
Screwdriver type	Flat Ø 6.5 / Pozidriv 2

Note: The utilization of LD38-4 additional terminal blocks does not allow the use of BER and BEY connection sets.

Main dimensions mm, inches

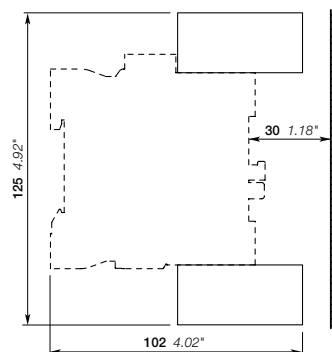

1SBC10734S0201

Terminal shrouds



1SBC100073V0014

LT65-30

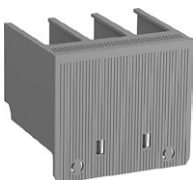

1SFC101038V0001

LT140-30L



1SFC101041V0001

LT370-30C



1SFC101039V0001

LT460-AC



1SBC100075V0014

LT80-40



1SFC101199V0001

LT205-40

Description

Main terminal protection for AF40 ... AF1250 contactors.

The auxiliary contact blocks and coils are designed to provide an IP 20 degree of protection.

The main terminals, equipped with compression lugs or cable clamps, can be protected against accidental direct contact after wiring (EN 50274) by the addition of terminal shrouds (see table below).

Ordering details

For contactors	Type	Order code	Pkg qty	Weight (1 pce) kg
3-pole contactors				
AF40 ... AF65	LT65-30	1SBN123401R1000	1	0.015
AF80, AF96	LT96-30	1SBN123901R1000	1	0.020
AF116 ... AF146, with compression lugs	LT140-30L	1SFN124203R1000	2	0.070
AF190, AF205, with cable clamps	LT205-30C	1SFN124801R1000	2	0.050
AF190, AF205, with compression lugs	LT205-30L	1SFN124803R1000	2	0.220
AF190, AF205, with shorting bar or between contactor and TOL/EOL in DOL starters	LT205-30Y	1SFN124804R1000	1	0.050
AF265 ... AF370, with cable clamps	LT370-30C	1SFN125401R1000	2	0.035
AF265 ... AF370, with compression lugs	LT370-30L	1SFN125403R1000	2	0.280
AF265 ... AF370, with shorting bar or between contactor and TOL/EOL in DOL starters	LT370-30Y	1SFN125404R1000	1	0.075
AF265 ... AF370, for use with extending cable clamps, ATK300/2 and OZXB4	LT370-30D	1SFN125406R1000	1	0.15
AF400, AF460 with cable clamps	LT460-AC	1SFN125701R1000	2	0.100
AF400, AF460 with compression lugs	LT460-AL	1SFN125703R1000	2	0.800
AF580, AF750 with cable clamps	LT750-AC	1SFN126101R1000	2	0.120
AF580, AF1250 with compression lugs	LT750-AL	1SFN126103R1000	2	0.825
4-pole contactors				
AF40, AF52	LT52-40	1SBN123402R1000	1	0.020
AF80	LT80-40	1SBN123902R1000	1	0.025
AF116 ... AF140, with compression lugs	LT140-40L	1SFN124203R2000	2	0.090
AF190 ... AF205, with cable clamps	LT205-40C	1SFN124801R2000	2	0.035
AF190 ... AF205, with compression lugs	LT205-40L	1SFN124803R2000	2	0.140
AF265 ... AF370, with cable clamps	LT370-40C	1SFN125401R2000	2	0.040
AF265 ... AF370, with compression lugs	LT370-40L	1SFN125403R2000	2	0.165

Note: With LT65-30, LT96-30, LT52-40, LT80-40, use rigid cables or flexible cables with insulated ferrules including a stripping length \geq 18 mm.

Terminals for control lead connections



LK96-4F



LK96-4B



LK96-4L

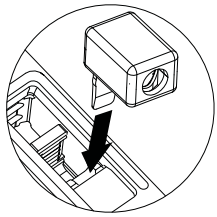

LK positioning

Description

Terminals designed to connect the control conductors to the main poles of the AF40 ... AF96 contactors and derivative versions.

Accessories clipped into the slots placed above each power terminal connector.

The LK96-4 are fitted with a pin designed to hold them in place until the connector has been fully clamped with its power cable.

Ordering details

For contactors	Type	Order code	Pkg qty	Weight (1 pce)
Opposite on AF40 ... AF96	LK96-4F	1SBN073452R2000	2	0.005 kg
Opposite on AF40 ... AF96 for use with BER, BEY connection sets	LK96-4B	1SBN073452R3000	2	0.007
Right and left on AF40 ... AF96	LK96-4L	1SBN073452R1000	2	0.006

Technical data

Types	LK96-4F	LK96-4B	LK96-4L
Connection capacity (min. ... max.)			
Rigid	1 x 1 ... 2.5 mm ²		
	2 x 1 ... 2.5 mm ²		
Flexible with non insulated ferrule	1 x 0.75 ... 2.5 mm ²		
	2 x 0.75 ... 2.5 mm ²		
Flexible with insulated ferrule	1 x 0.75 ... 2.5 mm ²		
	2 x 0.75 ... 1.5 mm ²		
Bars or lugs	L < 8 mm		
Connection capacity acc. to UL/CSA	1 or 2 x AWG 18 ... 14		
Stripping length	10 mm		
Tightening torque	1.2 Nm / 11 lb.in		
Degree of protection			
acc. to IEC 60947-1 / EN 60947-1 and IEC 60529 / EN 60529		IP20	
Screw terminals			
Main terminals		Delivered in open position, screws of unused terminals must be tightened	
		M3.5	
	Screwdriver type	Flat Ø 5.5 / Pozidriv 2	

Main dimensions

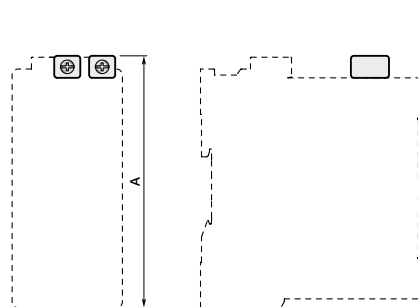

LK96-4F or LK96-4L on AF40 ... AF96

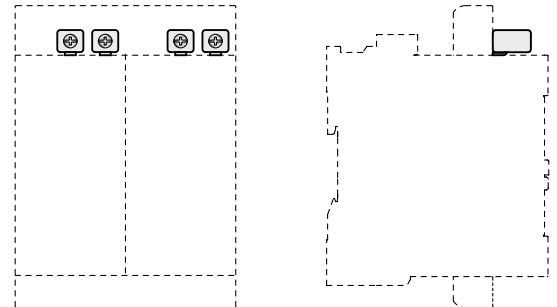

LK96-4B on AF40 ... AF96 using BER or BEY connection sets

	LK96-4F	LK96-4L
A	A	A
AF40 ... AF65	125.8 mm / 4.95"	127.8 mm / 5.03"
AF80 ... AF96	126.8 mm / 4.99"	128.8 mm / 5.07"

Note: utilization of side-by-side mounting of LK96-4L is not permitted on AF40 ... AF65 for UL application.



LW140

1SFC101058V0001



LW205-40

Terminal enlargements

Description

Enlargement pieces designed to increase the width of the contactor terminal pads in order to allow larger connections to be mounted.

Ordering details

For contactors	Dimensions		Type	Order code	Pkg qty	Weight (1 pce)
	hole Ø mm	bar mm				
3-pole contactors						
AF116 ... AF146	6.5	13 x 3	LW140	1SFN074207R1000	1	0.115
AF190, AF205	10.5	17.5 x 5	LW205	1SFN074807R1000	1	0.260
AF265 ... AF370	10.5	25 x 5	LW370	1SFN075407R1000	1	0.340
AF400, AF460	10.5	25 x 5	LW460	1SFN075707R1000	1	0.730
AF580, AF750	13	40 x 6	LW750	1SFN076107R1000	1	1.230
AF1250	13	50 x 10	LW1250	1SFN076407R1000	1	2.000
4-pole contactors						
AF190 ... AF205	10.5	20 x 5	LW205-40	1SFN074807R2000	1	0.306
AF265 ... AF370	10.5	25 x 5	LW370-40	1SFN075407R2000	1	0.540

Terminal extension

Description

Extension pieces designed to extend the main terminals of contactors for combined mounting of contactors and connection sets.

Ordering details

For 3-pole contactors	Dimensions		Type	Order code	Pkg qty	Weight (1 pce)
	hole Ø mm	bar mm				
AF116 ... AF146	6.5	13 x 3	LX140	1SFN074210R1000	1	0.072
AF190, AF205	8.5	17.5 x 5	LX205	1SFN074810R1000	1	0.180
AF265 ... AF370	10.5	20 x 5	LX370	1SFN075410R1000	1	0.234
AF400, AF460	10.5	25 x 5	LX460	1SFN075710R1000	1	0.500
AF580, AF750	13	40 x 6	LX750	1SFN076110R1000	1	0.850



LX140

1SFC101049V0001



LL146-30

1SFC101073V0001



Connection sockets

Description

Connection socket can be used to replace built-in cable clamps in AF116 ... AF146.

Ordering details

For contactor	Type	Order code	Pkg qty	Weight (1 pce)
3-pole contactors				
AF116 ... AF146	LL146-30	1SFN074211R1000	6	0.102
4-pole contactors				
AF116 ... AF140	LL146-40	1SFN074211R2000	8	0.132
AF190 ... AF205	LL205-40	1SFN074811R2000	2	0.216
AF265 ... AF370	LL370-40	1SFN075411R2000	2	0.224

Connection module

Description

Connection module can be fixed on AF116 ... AF146 delivered with bar terminals.

Ordering details

For contactor	Type	Order code	Pkg qty	Weight (1 pce)
3-pole contactors				
AF116 ... AF146	LD146-30	1SFN074208R1000	2	0.165
4-pole contactors				
AF116 ... AF140	LD146-40	1SFN074208R2000	2	0.225



LD146-30

1SFC101046V0001

Terminal connecting strips and shorting bars



LY16-4

1SBC100024V0014



LY185

1SBC101088V0001



LH38-4

1SBC1001038V0014



LF16-4

1SBC100037V0014



LG16-4

1SBC1001038V0014

Description

Parallel and series connection of 3-pole contactors:

- To obtain a star point (3 parallel-connected poles)
- To connect poles in parallel and thus increase the AC load passing through the flow path made up of the parallel-connected poles: LP, LY, LH, LF, LG.
The relevant cable cross-sectional area may limit the maximum permissible current. Consult information in table below
- To connect poles in series and thus increase the DC load controlled by the poles: LP, LY (only LY16-4 and LY38-4 secable strips).

Types	for connection of "n" poles	with terminal	insulated
LP	n = 2	no	no (1)
LY	n = 2 (secable LY16-4, LY38-4 connecting strips)	no	yes
	n = 3	no	yes (1)
LH	n = 2	yes	no
LF	n = 3	yes	yes
LG	n = 4	yes	yes

(1) LP460 ... LP750, LY185 ... LY750 not insulated. Use terminal shrouds.

Ordering details

For contactors	max. nominal continuous current with "n" poles				Cable cross-sectional area mm ²	Type	Order code	Pkg qty	Weight (1 pce) kg
	in parallel		in series						
	2 poles	3 poles	4 poles	2 poles					
AF09	30	33	-	25	6	LY16-4	1SBN071303T1000	10	0.006
AF12	32	36	-	27					
AF16	34	40	-	30					
AF26	50	60	-	45	10	LY38-4	1SBN072303T1000	10	0.012
AF116 ... AF146	-	240	-	-	-	LY140	1SFN074203R1000	1	0.055
AF190, AF205	-	400	-	-	-	LY185	1SFN074703R1000	1	0.200
AF265 ... AF370	-	670	-	-	-	LY300	1SFN075103R1000	1	0.300
AF400, AF460	-	1000	-	-	-	LY460	1SFN075703R1000	1	0.450
AF580, AF750	-	1650	-	-	-	LY750	1SFN076103R1000	1	0.800
AF190, AF205	300	-	-	-	-	LP185	1SFN074712R1000	2	0.300
AF265 ... AF370	475	-	-	-	-	LP300	1SFN075112R1000	2	0.400
AF400, AF460	725	-	-	-	-	LP460	1SFN075712R1000	2	0.550
AF580, AF750	1200	-	-	-	-	LP750	1SFN076112R1000	2	0.950
AF09	45	-	-	-	10	LH38-4	1SBN072304R1000	2	0.012
AF12	50	-	-	-	10				
AF16	54	-	-	-	16				
AF26	81	-	-	-	25				
AF30, AF38	90	-	-	-	25				
AF09	-	62	-	-	16	LF16-4	1SBN071305R1000	2	0.020
AF12	-	70	-	-	25				
AF16	-	75	-	-	25				
AF26	-	112	-	-	35	LF38-4	1SBN072305R1000	2	0.040
AF30, AF38	-	125	-	-	50				
AF09	-	-	70	-	25	LG16-4	1SBN071306R1000	2	0.025
AF12	-	-	78	-	25				
AF16	-	-	84	-	25				

Main dimensions

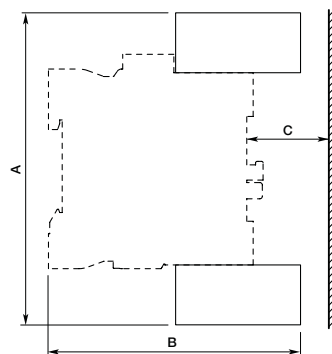

Type	For contactors	Dimensions					
		A		B		C	
		mm	inch	mm	inch	mm	inch
LH38-4	AF09 ... AF16	111.20	4.38"	83	3.27"	22	0.87"
	AF26 ... AF38	114	4.49"	86	3.39"	16	0.63"
LF16-4	AF09 ... AF16	121	4.76"	87	3.43"	23	0.91"
LF38-4	AF26 ... AF38	135.20	5.32"	103	4.06"	31	1.22"
LG16-4	AF09 ... AF16	124.20	4.89"	87	3.43"	23	0.91"

Connection accessories for starting solutions



BEA16-4

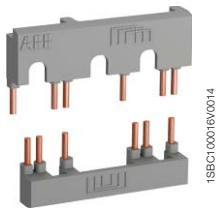

BER16-4

Connecting links with manual motor starters

Description

The BEA insulated 3-pole connecting links are used to connect AF09 ... AF38 contactors with the MS116 or MS132 or MS165 manual motor starters.

The BEA insulated 3-pole connecting links ensure the electrical and mechanical connection between the contactor and the associated manual motor starter.

Ordering details

For 3-pole contactors	Manual motor starter	Type	Order code	Pkg qty	Weight (1 pce) kg
AF09 ... AF16	MS116-0.16 ... MS116-25, MS132-0.16 ... MS132-25	BEA16-4	1SBN081306T1000	10	0.025
AF26 ... AF38	MS116-0.16 ... MS116-16, MS132-0.16 ... MS132-10 MS116-20 ... MS116-32, MS132-12 ... MS132-32	BEA26-4 BEA38-4	1SBN082306T1000 1SBN082306T2000	10	0.025 0.030
AF40 ... AF65	MS165-16 ... MS165-65	BEA65-4	1SBN083406R1000	1	0.090

Connection sets for reversing contactors

Description

The BER and BEM connection sets are used to connect the main poles of two 3-pole contactors mounted side by side.

The BER connection sets are made up of 1 upstream and 1 downstream connections.

The BEM connection sets are made up of 3 upstream and 3 downstream connections.

BER and BEM connection sets are insulated and made of solid copper bars.

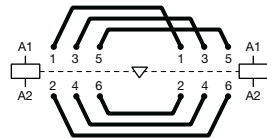

BER, BEM
Reversing connections



BEP140-30

Ordering details

For 3-pole contactors	Type	Order code	Pkg qty	Weight (1 pce) kg
AF09 ... AF16	BER16-4	1SBN081311R1000	1	0.045
AF26 ... AF38	BER38-4	1SBN082311R1000	1	0.100
AF40 ... AF65	BER65-4	1SBN083411R1000	1	0.175
AF80, AF96	BER96-4	1SBN083911R1000	1	0.250
AF116 ... AF146	BER140-4	1SFN084211R1000	1	0.615
AF190, AF205	BER205-4	1SFN084811R1000	1	1.237
AF265 ... AF370	BER370-4	1SFN085411R1000	1	2.140
AF400, AF460	BEM460-30	1SFN085701R1000	1	4.400
AF580, AF750	BEM750-30	1SFN086101R1000	1	7.300

Phase to phase connections

Description

The BEP and BES connection sets are used to connect phase to phase the main poles of two contactors mounted side by side. 4-pole contactors will then operate as source reversing contactors.

The BEP connection sets are made up of 1 upstream or downstream connections.

The BES connection sets are made up of 3 upstream or downstream connections.

BEP and BES connection sets are insulated and made of solid copper bars.

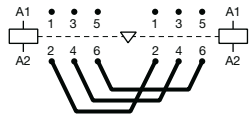

BEP, BES
3-pole phase to phase connections

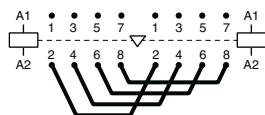

BEP
4-pole changeover connections

Ordering details

For contactors	Type	Order code	Pkg qty	Weight (1 pce) kg
3-pole contactors				
AF116 ... AF146	BEP140-30	1SFN084214R1000	1	0.320
AF190, AF205	BEP205-30	1SFN084814R1000	1	0.534
AF265 ... AF370	BEP370-30	1SFN085414R1000	1	0.926
AF400, AF460	BES460	1SFN085704R1000	1	2.200
AF580, AF750	BES750	1SFN086104R1000	1	3.700
4-pole contactors				
AF116 ... AF140	BEP140-40	1SFN084214R2000	1	0.420
AF190 ... AF205	BEP205-40	1SFN084814R2000	1	0.710
AF265 ... AF370	BEP370-40	1SFN085414R2000	1	1.230

Connection sets for star-delta starter

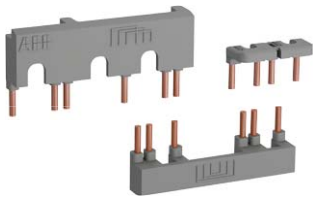

BEY16-4

1SBC100018V0014

Description

The BEY and BED connection sets are used to connect the main poles of the Line, Delta and Star contactors of a star-delta starter.

The connection sets are made up of:

- Line contactor / delta contactor:
 - BEY: upstream phase-to-phase connection
 - BED: upstream connection in parallel
- Delta contactor / star contactor: downstream connection in parallel
- Star contactor: star point upstream
- Insulated, solid copper bar.

Ordering details

For 3-pole line, delta & star contactors	Interlock unit between delta & star contactors	Type	Order code	Pkg qty	Weight (1 pce) kg
AF09 ... AF16	With or without VM4 or VEM4	BEY16-4	1SBN081313R2000	1	0.050
AF26 ... AF38	With or without VM4 or VEM4	BEY38-4	1SBN082713R2000	1	0.110
AF40 ... AF65	With or without VM96-4	BEY65-4	1SBN083413R2000	1	0.200
AF80, AF96	With or without VM96-4	BEY96-4	1SBN083913R2000	1	0.250
AF116 ... AF146	With or without VM19	BEY140-4	1SFN084413R1000	1	1.040
AF190 ... AF205 (line and delta) AF140 ... AF146 (star)	With or without VM140/190	BEY190-4	1SFN084813R1000	1	1.154
AF190, AF205	With or without VM19	BEY205-4	1SFN085213R1000	1	1.205
AF265 ... AF370 (line and delta) AF190 ... AF205 (star)	With or without VM205/265	BEY265-4	1SFN085413R1000	1	2.020
AF265 ... AF370	With or without VM19	BEY370-4	1SFN085813R1000	1	2.110
AF400 ... AF460	With or without VM750H	BED460	1SFN085703R1000	1	4.700
AF580 ... AF750 (line and delta) AF400 ... AF460 (star)	With or without VM750H	BED580	1SFN085903R1000	1	6.300
AF580 ... AF750	With or without VM750H	BED750	1SFN086103R1000	1	7.700

5

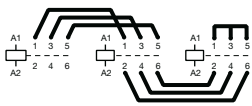

AF09 ... AF370
Line-delta-star connection

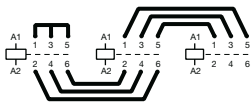

AF400 ... AF750
Star-delta-line connection

Connection bars

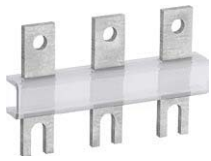

BEA140/XT2

1SFC101061V0001



BEA205/T4

1SFC101064V0001



BEA370/T5

1SFC101065V0001

Connection bars between contactors and MCCB

Description

Connection between contactors/starters and moulded case circuit breakers. These connection sets are solid copper bars.

Ordering details

For 3-pole contactors	MCCB	Type	Order code	Pkg qty	Weight (1 pce)
					kg

Vertical assembly

AF116 ... AF146	XT2	BEA140/XT2	1SFN084206R1000	1	0.058
AF116 ... AF146	XT4	BEA140/XT4	1SFN084206R1001	1	0.068
AF190, AF205	XT4	BEA205/XT4	1SFN084806R1000	1	0.200
AF190, AF205	T4	BEA205/T4	1SFN084806R1001	1	0.190
AF265 ... AF370	T5	BEA370/T5	1SFN085406R1000	1	0.350
AF400 ... AF750	T6	BEA750/T6	1SFN086106R1000	1	0.410
AF400 ... AF750	T5	BEA750/T5	1SFN086106R1001	1	0.410

Vertical assembly with control wire terminals (also suitable when using busbar kits for starter combinations)

AF400 ... AF750	T5	BEA750D/T5	1SFN086106R1003	1	0.720
AF400 ... AF750	T6	BEA750D/T6	1SFN086106R1002	1	0.720

Horizontal assembly (also suitable when using busbar kits for starter combinations)

AF400, AF460	T4	BEA460H/T4	1SFN085907R1000	1	2.450
--------------	----	------------	-----------------	---	-------

Connection bars between contactors and switch fuse

Description

Connection between contactors/starters and moulded case circuit breakers. These connection sets are solid copper bars.

Ordering details

For 3-pole contactors	Switch fuse	Type	Order code	Pkg qty	Weight (1 pce)
					kg

Vertical assembly

AF400, AF460	OESA400	BEF460/OESA400	1SFN085708R1000	1	0.340
AF460 ... AF750	OESA630 to OESA800	BEF750/OESA800	1SFN086108R1000	1	0.740

Horizontal assembly

AF400, AF460	OESA400...LR	OESA460H/OESA400	1SFN085709R1000	1	1.250
--------------	--------------	------------------	-----------------	---	-------

Note: The BEF connection bars provided for the A145 ... A300 contactors can be used for the AF145 ... AF300 contactors.

Mounting plates



PN460

1SFC1010670001

Description

Mounting plates with fixing holes for the specified 3-pole contactors and overload relays.

Ordering details

For 3-pole contactors	For overload relays	Type	Order code	Pkg qty	Weight (1 pce)
-----------------------	---------------------	------	------------	---------	----------------

Mounting plates for Direct on line starters

AF400, AF460	E500DU	PN460-11	1SFN095705R1000	1	2.120
AF580, AF750	E800DU	PN750-11	1SFN096105R1000	1	2.500

For two contactors side by side with space for mechanical interlock	For one or two overload relays	Type	Order code	Pkg qty	Weight (1 pce)
---	--------------------------------	------	------------	---------	----------------

Mounting plates for mechanical interlocked contactors, reversing starters and two speed starters for double windings

AF400, AF460	E500DU	PN460-21	1SFN095701R1000	1	3.490
AF580, AF750	E800DU	PN750-21	1SFN096101R1000	1	4.230

For main and delta contactors	For star contactor (1)	For overload relays	Type	Order code	Pkg qty	Weight (1 pce)
-------------------------------	------------------------	---------------------	------	------------	---------	----------------

Mounting plates for star-delta starters and two speed starters for single windings

AF400, AF460	A300, AF400	E500DU	PN460-41	1SFN095703R1000	1	5.310
AF580, AF750	AF400 ... AF580	E800DU	PN750-41	1SFN096103R1000	1	6.320

(1) Space for mechanical interlock included.

Adapter plates

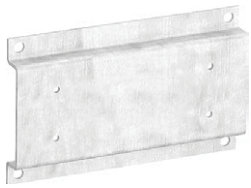

1SFC101048/0001

PR146-1

Description

Adapter plates with fixing holes for replacing installed contactors.

Ordering details

From contactors	To contactor	Type	Order code	Pkg qty	Weight (1 pce) kg
A95, AF95, A110, AF110	AF116, AF140, AF146	PR146-1	1SFN094200R1000	1	0.300
EH150, EH160, EH175, EH210, EG160	AF190, AF205	PR210-1	1SFN094900R1000	1	0.440
EH250, EH260, EH300	AF265, AF305, AF370	PR300-1	1SFN095300R1000	1	0.560
EH370, EH550, EG315	AF400, AF460, AF580	PR460-1	1SFN095700R1000	1	0.900
EH700, EH800	AF750	PR750-1	1SFN096100R1000	1	0.500
OKYM150, OKYM175	AF190	PR185-2	1SFN095100R1001	1	0.500
OKYM200, OKYM250	AF265, AF305, AF370	PR300-2	1SFN095300R1001	1	0.500
OKYM315	AF400, AF460	PR400-2	1SFN095700R1002	1	0.820
OKYM400	AF400, AF460	PR460-2	1SFN095700R1001	1	0.800
OKYM500	AF580	PR580-2	1SFN096100R1002	1	0.700
EH550, EG630, OKYM630	AF580, AF750	PR750-2	1SFN096100R1001	1	1.100

5

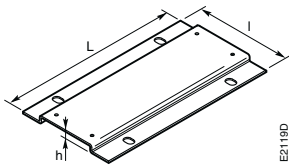

EZ119D

Dimensions (mm)

Type of the plate	Dimensions			Fixing holes mm
	L	l	h	
PR146-1	150	90	15	4 x \varnothing 6.5
PR210-1	200	132	11.5	4 x \varnothing 7
PR300-1	200	172	11.5	4 x \varnothing 7
PR460-1	278	198	11.5	4 x \varnothing 7
PR750-1	283	244	11.5	4 x \varnothing 7
PR185-2	202	152	11.2	4 x \varnothing 11
PR300-2	202	152	11.2	4 x \varnothing 11
PR400-2	278	151	11.5	4 x \varnothing 11
PR460-2	278	176	11.5	4 x \varnothing 11
PR580-2	283	176	11.5	4 x \varnothing 11
PR750-2	283	255	11.5	4 x \varnothing 14

Fixing holes according to the plate types

1SFC101107C0201

Low Voltage Ride Through (LVRT) modules



1SFC101223W0001

5

RU19/120

Description

RU19 is designed to meet the Low Voltage Ride Through (LVRT) requirements for grid connections by staying operational during voltage dips preventing disturbances on the grid it self.

The RU19 is a separate module connected to the contactors coil connection A1-A2 creating a delay function of the opening of the contactor. When controlled by PLC, the contactor is operated directly without delay functionality. The RU19 can be screw or DIN rail mounted.

Ordering details

For contactor	Rated control circuit voltage Uc V 50/60 Hz	Type	Order code	Weight Pkg (1 pce) kg
AF116 ... AF370 use coil 33 AF400 ... AF1250 use coil 69	110...120	RU19/120	1SFN170801R1001	0.400
AF116 ... AF370 use coil 33 AF400 ... AF1250 use coil 70	230...240	RU19/240	1SFN170801R1002	0.400

AF116 ... AF1250

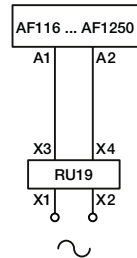

For direct opening of AF400 ... AF1250 contactors, connect through built in PLC interface.

Control inputs

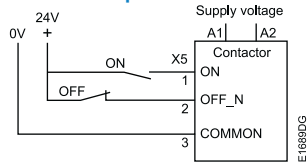

Main dimensions mm, inches

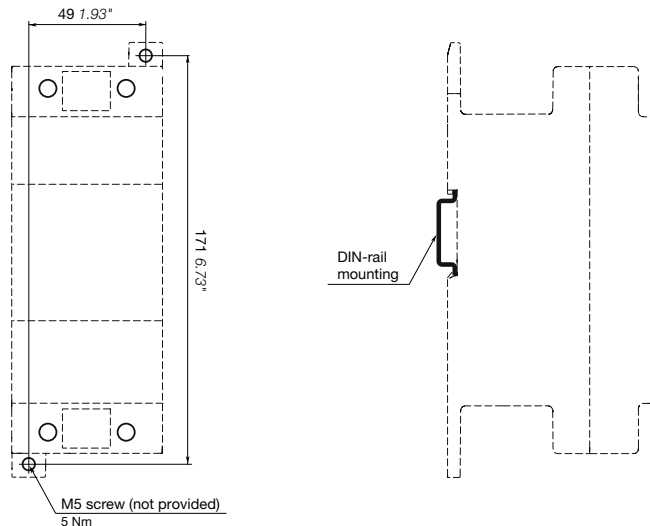

RU19/240

1SFC10107D0201

Contactors coils, main contact sets and arc chutes



ZAF1650

1SFC101007F0201

Contactors coils

Ordering details

For contactors	Rated control circuit voltage		Type	Order code	Pkg qty	Weight (1 pce)
	Uc min. ... Uc max.					
	V 50/60 Hz	V DC				
AF400, AF460	-	24...60	ZAF460	1SFN155770R6806	1	0.525
	48...130	48...130	ZAF460	1SFN155770R6906	1	0.525
	100...250	100...250	ZAF460	1SFN155770R7006	1	0.525
	250...500	250...500	ZAF460	1SFN155770R7106	1	0.525
AF580 ... AF1250	-	24...60	ZAF750	1SFN156170R6806	1	1.335
	48...130	48...130	ZAF750	1SFN156170R6906	1	1.335
	100...250	100...250	ZAF750	1SFN156170R7006	1	1.335
	250...500	250...500	ZAF750	1SFN156170R7106	1	1.335
AF1350 ... AF2050	100...250	100...250	ZAF1650 (1)	1SFN156570R7026	1 set	0.900
			ZP1650 (2)	1SFN166521R1070	1	0.300
AF2650	100...250	100...250	ZAF2650 (1)	1SFN156670R7026	1 set	0.900
			ZP2650 (2)	1SFN166621R1070	1	0.300

ZAF460, ZAF750 : printed circuit board included.

(1) One set of two coil.

(2) Printed circuit board.



ZL1650

1SFC101009F0201

Main contact sets

Description

The contact sets for 3-pole contactors consists of six fixed contacts, three moving contacts, springs and the required screws.

Ordering details

For 3-pole contactors		Type	Order code	Pkg qty	Weight (1 pce)
					kg
AF400		ZL400	1SFN165703R1000	1	1.320
AF460		ZL460	1SFN165903R1000	1	1.320
AF580		ZL580	1SFN166103R1000	1	1.840
AF750		ZL750	1SFN166303R1000	1	1.840
AF1250		ZL1250	1SFN166403R1000	1	1.840
AF1350	For contactors produced before 2014-01-13, with serial number before 1S16010051403xxxx	ZL1350	1SFN166503R1000	1	2 500
	For contactors produced since 2014-01-13, with serial number above 1S16010051403xxxx	ZL1350-1	1SFN166503R1001	1	4 500
AF1650	For contactors produced before 2014-01-13, with serial number before 1S16010051403xxxx	ZL1650	1SFN166703R1000	1	3 500
	For contactors produced since 2014-01-13, with serial number above 1S16010051403xxxx	ZL1650-1	1SFN166703R1001	1	4 500
AF2050	For contactors produced before 2014-01-13, with serial number before 1S16010051403xxxx	ZL2050	1SFN167003R1000	1	3 500
	For contactors produced since 2014-01-13, with serial number above 1S16010051403xxxx	ZL2050-1	1SFN167003R1001	1	4 500
AF2650 (3)		ZL2650	1SFN166603R1000	1	1.200

(3) Does not include fixed contacts and screws.

Arc chutes

Ordering details

For contactors	Type	Order code	Pkg qty	Weight (1 pce)
				kg
AF400, AF460	ZW460	1SFN165710R1000	1	1.380
AF580, AF750, AF1250	ZW750	1SFN166110R1000	1	1.500
AF1350, AF1650, AF2050	ZW1650	1SFN166510R1000	1	4.560
AF2650	ZW2650	1SFN166610R1000	1	4.000

Accessories for UA, UA..RA contactors and GA75, GAE75, GAF contactors

Auxiliary contact blocks	5/376
Electronic timers	5/382
Mechanical and electrical interlock units	5/385
CA5, CE5, CAL, CEL18 and TEF5 fitting details	5/387
Function markers - Mounting piece	5/388
Surge suppressors for contactor coils	5/389
Interface relays	5/391
Mechanical latching units	5/393
Additional terminal blocks and others accessories	5/395
Terminals for control lead connections	5/396
Contactor coils and main contact sets	5/397

Voltage code table	5/410
------------------------------------	-------

Auxiliary contact blocks



CA5-10



CA5-40E



CAL5-11



CAL18-11

Description

The auxiliary contact blocks are used for the operation of auxiliary circuits and control circuits for standard industrial environments.

Types of auxiliary contact blocks for front mounting:

- CA5 1 or 4-pole block, instantaneous with N.O., N.C. contacts
- CC5 1-pole block, with N.O. leading contact or N.C. lagging contact.

Select the 4-pole auxiliary contact blocks CA5 type, according to the contactor type for compliance with the standard requirements (see "Terminal Marking and Positioning").



Types of auxiliary contact blocks for side mounting:

- CAL 2-pole block instantaneous N.O. + N.C. contacts.

For clipping onto the right- and/or left-hand side of the contactors.

The auxiliary contact blocks are equipped with screw type connecting terminals delivered open, protected against accidental direct contact and bear the corresponding function marking.

Ordering details (1)

For contactors	Auxiliary contacts	Type	Order code	Pkg qty	Weight (1 pce)
	 				kg

Front-mounted instantaneous auxiliary contact blocks, 1-pole

UA16 ... UA110	NO	NC	Type	Order code	Pkg qty	Weight (1 pce)
	1	0	CA5-10	1SBN010010R1010	10	0.014
	0	1	CA5-01	1SBN010010R1001	10	0.014
	-	-	CC5-10	1SBN010011R1010	10	0.014
	-	-	CC5-01	1SBN010011R1001	10	0.014

Front-mounted instantaneous auxiliary contact blocks, 4-pole

UA16 ... UA30	NO	NC	Type	Order code	Pkg qty	Weight (1 pce)
	2	2	CA5-22M	1SBN010040R1122	2	0.060
	3	1	CA5-31M	1SBN010040R1131	2	0.060
	1	3	CA5-13M	1SBN010040R1113	2	0.060
	0	4	CA5-04M	1SBN010040R1104	2	0.060
	1	1	CA5-11/11M	1SBN010040R1118	2	0.060
UA50 ... UA110	2	2	CA5-22E	1SBN010040R1022	2	0.060
	3	1	CA5-31E	1SBN010040R1031	2	0.060
	4	0	CA5-40E	1SBN010040R1040	2	0.060
	0	4	CA5-04E	1SBN010040R1004	2	0.060
	1	1	CA5-11/11E	1SBN010040R1018	2	0.060

Side-mounted instantaneous auxiliary contact blocks, 2-pole

UA16 ... UA75	NO	NC	Type	Order code	Pkg qty	Weight (1 pce)
	1	1	CAL5-11	1SBN010020R1011	2	0.050
UA95, UA110	1	1	CAL18-11	1SBN010720R1011	2	0.050

(1) For each contactor type, refer to "Accessory fitting details" table.

Note:

- The front-mounted auxiliary contact blocks provided for the UA75 contactors can be used with the GA and GAE types
- The CAL auxiliary contact blocks can be used with GA contactors:
 - GA75-10-00: 2 x CAL5-11 blocks
 - GA75-10-11: 1 x CAL5-11 block
 - GAE75-10-00: 1 x CAL5-11 block
 - GAE75-10-11: no add-on block.
- The CAL auxiliary contact blocks can be used with UA..RA contactors. See "Accessory fitting details" for this contactor type.

Auxiliary contact blocks

Technical data

	Front mounted	Side mounted
Types	1-pole CA5, 1-pole CC5, 4-pole CA5	CAL5-11 CAL18-11, CAL18-11B





Contact utilization characteristics according to IEC

Standards	IEC 60947-5-1 and EN 60947-5-1		
Rated insulation voltage U_i acc. to IEC 60947-5-1	690 V		
Rated operational voltage U_e max.	24...690 V AC		
Conventional thermal current I_{th} - $\theta \leq 40$ °C	16 A		
I_e / Rated operational current AC-15 acc. to IEC 60947-5-1	24-127 V 50/60 Hz	6 A	
	220-240 V 50/60 Hz	4 A	
	380-440 V 50/60 Hz	3 A	
	500-690 V 50/60 Hz	2 A	
Making capacity acc. to IEC 60947-5-1	10 x I_e AC-15		
Breaking capacity acc. to IEC 60947-5-1	10 x I_e AC-15		
I_e / Rated operational current DC-13 acc. to IEC 60947-5-1	24 V DC	6 A / 144 W	
	48 V DC	2.8 A / 134 W	
	72 V DC	1 A / 72 W	
	110 V DC	0.55 A / 60 W	
	125 V DC	0.55 A / 69 W	
	220 V DC	0.3 A / 66 W	
	250 V DC	0.3 A / 75 W	
Short-circuit protection device gG type fuse	10 A		
Rated short-time withstand current I_{cw} $\theta = 40$ °C	for 1.0 s	100 A	
	for 0.1 s	140 A	
Minimum switching capacity			
A40 ... A75 contactors with failure rate acc. to IEC 60947-5-4	17 V / 1 mA	-	
	$\leq 10^{-7}$	-	
A95 ... A110 contactors with failure rate acc. to IEC 60947-5-4	24 V / 50 mA	-	24 V / 50 mA (0.5 million of operating cycles)
	-	-	$\leq 10^{-6}$
Power dissipation per pole at 6 A	0.1 W		0.15 W
Mechanical durability Number of operating cycles	10 millions (UA16 ... UA75) 3 millions (UA95 ... UA110)	10 millions	5 millions (UA95 ... UA110) 3 millions (GAF185 ... GAF750) 0.5 million (GAF1250 ... GAF2050)
Electrical durability			
Max. switching frequency	3600 cycles/h		
Number of operating cycles	see "Electrical durability" curves		
Max. switching frequency	AC-15	1200 cycles/h	
	DC-13	900 cycles/h	

Contact utilization characteristics according to UL / CSA

Standards	UL 508, CSA C22.2 N°14
Max. operational voltage	600 V AC, 250 V DC
Pilot duty	A600, Q300
AC thermal rated current	10 A

Connecting characteristics

Connection capacity (min. ... max.)			
	Rigid solid	1 x	1...4 mm ²
	Flexible with ferrule	2 x	1...4 mm ²
	Flexible with ferrule	1 x	0.75...2.5 mm ²
	Flexible with ferrule	2 x	0.75...2.5 mm ²
	Lugs	L ≤	7.7 mm
		L >	3.7 mm
			8 mm
			3.7 mm
Tightening torque	1 Nm		
Degree of protection	Terminals	IP20	
acc. to IEC 60947-1 / EN 60947-1 and IEC 60529 / EN 60529			
Screw terminals	Delivered in open position, screws of unused terminals must be tightened		
All terminals	M3.5		
Screwdriver type	Flat Ø 5.5 / Pozidriv 2		

Auxiliary contact blocks for severe industrial environments



CE5-01W

Description

The auxiliary contact blocks are used for the operation of auxiliary and control circuits for severe industrial environments.

Types of auxiliary contact blocks for front mounting:

- CE5 1-pole block, instantaneous with N.O. contact or N.C. contact, designed in 2 protection versions:
 - CE5-... D with built-in microswitch IP40, degree of protection (IP20 on terminals)
 - CE5-... W with built-in microswitch IP67, degree of protection (IP20 on terminals).

Types of auxiliary contact blocks for side mounting:

- CEL18 1-pole block with built-in microswitch IP67 degree of protection (IP20 on terminals). Instantaneous N.O. or N.C. contact.

For clipping onto the right- and/or left-hand side of the contactors.

The auxiliary contact blocks are equipped with screw type connecting terminals delivered open, protected against accidental direct contact and bear the corresponding function marking.

Ordering details (1)

For contactors	Auxiliary contacts	Type	Order code	Pkg qty	Weight (1 pce)
					kg
Front-mounting instantaneous auxiliary contact blocks, 1-pole					
UA16 ... UA75	1 - - -	CE5-10D0.1	1SBN010015R1010	1	0.020
	- 1 - -	CE5-01D0.1	1SBN010015R1001	1	0.020
	1 - - -	CE5-10D2	1SBN010017R1010	1	0.020
	- 1 - -	CE5-01D2	1SBN010017R1001	1	0.020
	1 - - -	CE5-10W0.1	1SBN010016R1010	1	0.020
	- 1 - -	CE5-01W0.1	1SBN010016R1001	1	0.020
	1 - - -	CE5-10W2	1SBN010018R1010	1	0.020
	- 1 - -	CE5-01W2	1SBN010018R1001	1	0.020
Side-mounting instantaneous auxiliary contact blocks, 1-pole microswitch auxiliary contact N.O. or N.C.					
UA95, UA110	1 0 - -	CEL18-10	1SFN010716R1010	1	0.050
UA95, UA110	0 1 - -	CEL18-01	1SFN010716R1001	1	0.050

(1) For each contactor type, refer to "Accessory fitting details" table.

Note: The front-mounted auxiliary contact blocks provided for the UA contactors can be used with the GA and GAE types. The side-mounted auxiliary contact blocks provided for the UA95, UA110 contactors can be used with the GAF types.

Auxiliary contact blocks

Technical data

	Front-mounted		Side-mounted
Types	1-pole CE5-..0.1	1-pole CE5-..2	CEL18-10, CEL18-01





Contact utilization characteristics according to IEC

Standards	IEC 60947-5-1 and EN 60947-5-1		
Rated insulation voltage U_i acc. to IEC 60947-5-1	250 V		
Rated operational voltage U_e max.	125 V	250 V	125 V
Conventional thermal current $I_{th} - \theta \leq 40 \text{ °C}$	0.1 A	2 A	0.1 A
I_e / Rated operational current	AC-14	AC-15	AC-14
acc. to IEC 60947-5-1			
	24-127 V 50/60 Hz	2 A	0.1 A
	220-240 V 50/60 Hz	2 A	–
Making capacity acc. to IEC 60947-5-1	6 x I_e AC-14	10 x I_e AC-15	6 x I_e AC-14
Breaking capacity acc. to IEC 60947-5-1	6 x I_e AC-14	10 x I_e AC-15	6 x I_e AC-14
I_e / Rated operational current	DC-12		
acc. to IEC 60947-5-1			
	24 V DC	2 A	0.1 A
	48 V DC	1 A	0.1 A
	72 V DC	0.3 A	0.1 A
	110 V DC	0.2 A	0.1 A
	125 V DC	0.2 A	–
	220 V DC	0.1 A	–
Short-circuit protection device	0.1 A (FF type fuses) (1)	10 A (FF type fuses) (1)	0.1 A (FF type fuses) (1)
Minimum switching capacity			
A40 ... A75 contactors	3 V / 1 mA	17 V / 1 mA	3 V / 1 mA
With failure rate acc. to IEC 60947-5-4	–	$\leq 10^{-7}$	–
A95 ... A110 contactors	3 V / 1 mA	17 V / 1 mA	–
With failure rate acc. to IEC 60947-5-4	–	$\leq 10^{-7}$	–
Mechanical durability	Number of operating cycles	5 millions for CE5-..D0.1 2.5 millions for CE5-..W0.1	5 millions for CE5-..D2 2.5 millions for CE5-..W2 1 million
	Max. switching frequency	3600 cycles/h	1200 cycles/h
Electrical durability	Number of operating cycles	2.5 millions for CE5-..D0.1 0.7 millions for CE5-..W0.1	1 million for CE5-..D2 0.3 millions for CE5-..W2 0.7 millions
	Max. switching frequency	AC-14, AC-15 DC-12	900 cycles/h

Contact utilization characteristics according to UL / CSA

Standards	UL 508, CSA C22.2 N°14		
Max. operational voltage	125 V AC / 110 V DC	250 V AC / 220 V DC	125 V
Pilot duty			
AC thermal rated current	0.1 A	2 A	0.1 A

Connecting characteristics

Connection capacity (min. ... max.)			
 Rigid solid	1 x	1...4 mm ²	
 Flexible with ferrule	2 x	1...4 mm ²	
 Flexible with ferrule	1 x	0.75...2.5 mm ²	
 Flexible with ferrule	2 x	0.75...2.5 mm ²	
 Bars or lugs	L ≤	7.7 mm	
	I >	3.7 mm	
Connection capacity acc. to UL/CSA	1 or 2 x	AWG 18...14	
Tightening torque		1 Nm	
Degree of protection	Terminals	IP20	
acc. to IEC 60947-1 / EN 60947-1 and IEC 60529 / EN 60529	Microswitches	IP40 for CE5-..D0.1 IP67 for CE5-..W0.1	IP40 for CE5-..D2 IP67 for CE5-..W2
			IP67
Screw terminals		Delivered in open position, screws of unused terminals must be tightened	
All terminals		M3.5	
Screwdriver type		Flat Ø 5.5 / Pozidriv 2	

(1) or HRC fuses for very fast action (6.3 x 32 mm size).

Auxiliary contacts

Electrical durability

Electrical durability for AC-15 utilization category

AC-15 utilization category according to IEC 60947-5-1 / EN 60947-5-1:

- making current: $10 \times I_e$ with $\cos \varphi = 0.7$ and U_e
- breaking current: I_e with $\cos \varphi = 0.4$ and U_e .

These curves represent the electrical durability of the built-in or add-on auxiliary contacts, in relation to the breaking current. The curves have been drawn for resistive and inductive loads up to 690 V, 40...60 Hz.

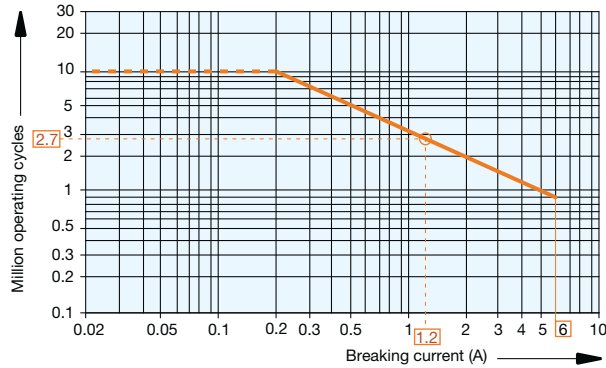

- 1-pole and 4-pole CA5,
- 1-pole CC5,
- 2-pole CAL5 and CAL18 add-on auxiliary contacts.

Example:

Breaking current = 1.2 A

On the opposite curve at intersection "O" 1.2 A the corresponding value for the electrical durability is approximately $2.7 \cdot 10^6$ operating cycles.

Electrical durability for DC-13 utilization category

DC-13 utilization category according to IEC 60947-5-1 / EN 60947-5-1: making and breaking current = I_e with U_e value.

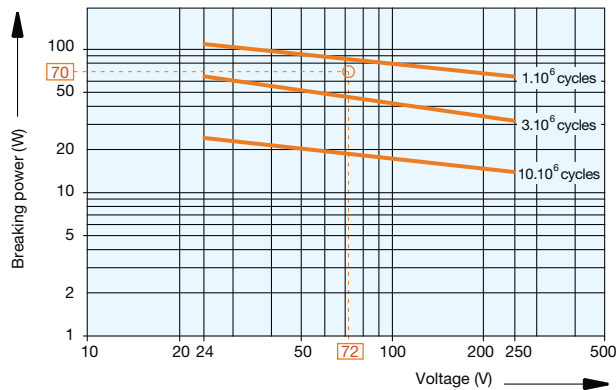

- 1-pole and 4-pole CA5,
- 1-pole CC5,
- 2-pole CAL5 and CAL18 add-on auxiliary contacts.

Example:

Control of DC electro-magnet: U_e voltage = 72 V DC and breaking power = 70 W.

On the opposite curve at intersection "O" 72 V / 70 W the corresponding value for the electrical durability is approximately $2 \cdot 10^6$ operating cycles.

Add-on auxiliary contacts

Terminal marking and positioning

1-pole auxiliary contacts

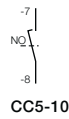
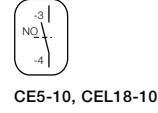
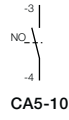
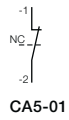

2-pole auxiliary contacts

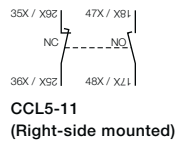
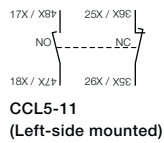
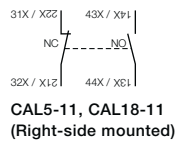
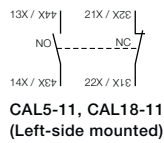

4-pole auxiliary contacts

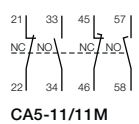
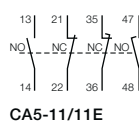
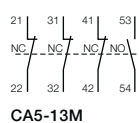
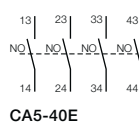
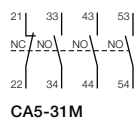
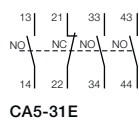
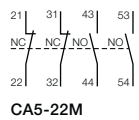
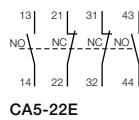
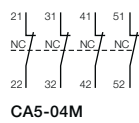
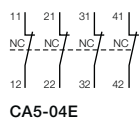

Electronic timers



TEF5-OFF

1SBC101389FF0014

Description

TEF5 frontal electronic timers are used for realizing timing function and are available in ON-delay and OFF-delay versions.

Compact solution in cabinet compared to separate timers

TEF5 electronic timers are front-mounted and locked on contactors. A mechanical indicator allows to show the state of the contactor.

TEF5 electronic timers are supplied by direct wiring to the coil terminals A1 - A2 of the contactor or contactor relay. A varistor is integrated on the timer to offer a built-in protection against surges in the contactor coil.

Available for a wide control voltage range 24...240 V AC/DC

TEF5-ON or TEF5-OFF allow time-delayed functions up to 100 s in 3 distinct time ranges, independently of the control system. The time delay ranges are selected by a switch and the time delay can be adjusted by means of a rotary switch. The timing function is activated by closing or opening the device on which the timer is mounted. The OFF-delay version operates without additional control supply.

Ordering details

For contactors, contactor relays	Time delay range selected by switch	Delay type	Rated control circuit voltage U_c V 50/60 Hz or DC	Auxiliary contacts 	Type	Order code	Weight Pkg (1 pce) kg
UA16 ... UA75 GA75, GAE75	0.1...1 s 1...10 s 10...100 s	ON-delay	24...240	1 1	TEF5-ON	1SBN020312R1000	0.065
		OFF-delay	24...240	1 1	TEF5-OFF	1SBN020314R1000	0.065

Electronic timers

Technical data

Contact utilization characteristics according to IEC

Types	TEF5-ON	TEF5-OFF
Standards	IEC 60947-5-1 and EN 60947-5-1	
Rated insulation voltage U_i acc. to IEC 60947-5-1	400 V	
Rated impulse withstand voltage U_{imp}	4 kV	
Rated operational voltage U_e max.	240 V	
Rated frequency (without derating)	50 / 60 Hz	
Conventional thermal current $I_{th} - \theta \leq 40^\circ\text{C}$	5 A	
I_e / Rated operational current AC-15 acc. to IEC 60947-5-1	24-127 V 50/60 Hz	3 A
	220-240 V 50/60 Hz	1.5 A
Making capacity	10 x I_e AC-15 acc. to IEC 60947-5-1	
Breaking capacity	10 x I_e AC-15 acc. to IEC 60947-5-1	
I_e / Rated operational current DC-13 acc. to IEC 60947-5-1	24 V DC	1 A / 24 W
Short-circuit protection device gG type fuse	6 A	
Rated short-time withstand current I_{cw} $\theta = 40^\circ\text{C}$	for 1.0 s	8 A
	for 0.1 s	8 A
Minimum switching capacity with failure rate acc. to IEC 60947-5-4	24 V DC	12 V / 3 mA
Power dissipation per pole at 3 A	0.1 W	
Function diagram	ON-delay	OFF-delay
	Bistable relay inside. Before use, once apply U_c then switch it off in order to initialize position of the contacts.	
Control circuit voltage		
AC control voltage	Rated control circuit voltage U_c	24...240 V AC
50/60 Hz	Average consumption	1.5 mA RMS
		1 mA RMS
DC control voltage	Rated control circuit voltage U_c	24...240 V DC
	Average consumption	1.5 mA
		1 mA
Rated frequency limits	50 / 60 Hz	
Supply voltage range	0.85...1.1 x U_c (at $\theta \leq 70^\circ\text{C}$)	
Overvoltage protection	Varistor included	
Time delay range (t) selected by switch	0.1...1 s	<input type="checkbox"/>
	1...10 s	<input type="checkbox"/>
	10...100 s	<input type="checkbox"/>
On-load reiteration accuracy under constant conditions	$\leq 1\%$	
Minimum ON period	0.1 s	1 s
Recovery time	0.15 s	0.1 s
Ambient air temperature	Operation	-25 °C ... +70 °C
	Storage	-40 °C ... +80 °C
Climatic withstand	Category B according to IEC 60947-1 Annex Q	
Maximum operating altitude	2000 m	
Mounting positions	Acc. to mounting positions permitted on contactors or contactor relays	
Shock withstand	1/2 sinusoidal shock for 11 ms: no change in contact position	
acc. to IEC 60068-2-27 and EN 60068-2-27 (Mounting position 1)	Same as contactor or contactor relay	
Mechanical durability	Number of operating cycles	5 millions operating cycles
	Max. switching frequency	3600 cycles/h
		1800 cycles/h
Max. electrical switching frequency	AC-15	1200 cycles/h
	DC-13	900 cycles/h





Electronic timers

Technical data

Contact utilization characteristics according to UL / CSA

Types	TEF5-ON	TEF5-OFF
Standards	UL 508, CSA C22.2 N°14	
Rated insulation voltage Ui	300 V	
acc. to UL / CSA	240 V	
Max. operational voltage	240 V	
Pilot duty	B300, R300	
AC thermal rated current	5 A	
AC maximum volt-ampere making	3600 VA	
AC maximum volt-ampere breaking	360 VA	
DC thermal rated current	1 A	
DC maximum volt-ampere making-breaking	28 VA	

Connecting characteristics

Connection capacity (min. ... max.)		
 Rigid solid	1 x	1...2.5 mm ²
	2 x	1...2.5 mm ²
 Flexible with non insulated ferrule	1 x	0.75...2.5 mm ²
	2 x	0.75...2.5 mm ²
 Flexible with insulated ferrule	1 x	0.75...2.5 mm ²
	2 x	0.75...1.5 mm ²
 Lugs	L ≤	8 mm
	L >	3.7 mm
Connection capacity acc. to UL / CSA	1 or 2 x	AWG 18...14
Stripping length		10 mm
Tightening torque		1 N.m / 9 lb.in
Degree of protection		IP20
acc. to IEC 60947-1 / EN 60947-1 and IEC 60529 / EN 60529		
Screw terminals		Delivered in open position, screws of unused terminals should be tightened
All terminals		M3.5
Screwdriver type		Flat Ø 5.5 / Pozidriv 2
Terminal Marking		

5

Mechanical and electrical interlock units



VE5-2

Description

When mounted between two contactors, the mechanical interlock unit prevents one of the contactors from closing as long as the other contactor is closed.

VE interlock units are used for mechanical and electrical interlocking of two AC or DC operated contactors mounted side by side.

Ordering details

For contactors	Mounting	Type	Order code	Pkg qty	Weight (1 pce) kg
Mechanical and electrical interlock units for two horizontal mounted contactors					
GA75, GAE75	Rail mounting	VE5-2	1SBN030210R1000	1	0.146

Mechanical and electrical interlock units

Technical data

Types	VE5-2
-------	-------



Contact utilization characteristics according to IEC

Standards	IEC 60947-5-1 and EN 60947-5-1	
Rated insulation voltage U_i acc. to IEC 60947-5-1	690 V	
Rated operational voltage U_e max.	24...690 V	
Conventional thermal current I_{th} - $\theta \leq 40$ °C	16 A	
le / Rated operational current AC-15 acc. to IEC 60947-5-1	24-127 V 50/60 Hz	6 A
	220-240 V 50/60 Hz	4 A
	380-440 V 50/60 Hz	3 A
	500-690 V 50/60 Hz	2 A
	Making capacity acc. to IEC 60947-5-1	10 x I_e AC-15
Breaking capacity acc. to IEC 60947-5-1	10 x I_e AC-15	
le / Rated operational current DC-13 acc. to IEC 60947-5-1	24 V DC	6 A
	48 V DC	2.8 A
	72 V DC	1 A
	125 V DC	0.55 A
	250 V DC	0.3 A
Short-circuit protection device - gG type fuse	10 A	
Rated short-time withstand current I_{cw} $\theta = 40$ °C	for 1.0 s	100 A
	for 0.1 s	140 A
Power dissipation per pole at 6 A	0.15 W	
Mechanical durability		
Number of operating cycles	5 millions operating cycles	
Max. switching frequency	600 cycles/h	

Utilization characteristics according to UL/CSA

Standards	UL 508, CSA C22.2 N°14
Max. operational voltage	600 V

Connecting characteristics

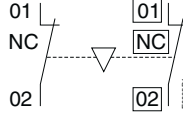
Connection capacity (min. ... max.)		
 Rigid solid	1 x	1...4 mm ²
	2 x	1...4 mm ²
 Flexible with ferrule	1 x	0.75...2.5 mm ²
	2 x	0.75...2.5 mm ²
 Lugs	L <	8 mm
	L >	3.5 mm
Tightening torque		
Recommended	1 Nm	
Max.	1.2 Nm	
Degree of protection		IP20
acc. to IEC 60947-1 / EN 60947-1 and IEC 60529 / EN 60529		
Screw terminals		delivered in open position, screws of unused terminals must be tightened
All terminals	M3.5	
Screwdriver type		Flat Ø 5.5 / Pozidriv 2
Terminal marking		

Technical note: when, during switching, the arc time is estimated to more than 40 ms, the closing signal of one of the two contactors must be delayed with respect to the opening signal of the other contactor in order to prevent a short-circuit.

Use a TEF5 electronic timer according to application use with time lapse for GA75, GAE75 contactors.

CA5, CE5, CAL, CEL18 and TEF5 fitting details

Many configurations are possible depending on whether these are front-mounted or side-mounted.

Contactor types	Main poles	Built-in auxiliary contacts	Front-mounted accessories			Side-mounted accessories		
			Auxiliary contact blocks	Electronic timer	Auxiliary contact blocks	Interlock unit		
			1-pole CA5 1-pole CE5	4-pole CA5	TEF5	2-pole CAL 1-pole CEL18	VE5	
UA contactors								
UA16 ... UA26	3 0	1 0	1 to 4 x CA5 1 to 2 x CE5 max. (1)	or 1 x 4-pole CA5 + 1 x 1-pole CA5 or CE5 (1)	or 1 x TEF5 + 1 x 1-pole CA5	+	1 to 2 x CAL5-11	-
UA30	3 0	1 0	1 to 5 x CA5 1 to 3 x CE5 max. (1)	or 1 x 4-pole CA5 + 1 x 1-pole CA5 or CE5 (1)	or 1 x TEF5 + 1 x 1-pole CA5	+	1 to 2 x CAL5-11	-
UA50 ... UA75	3 0	0 0	1 to 6 x CA5 1 to 5 x CE5 max. (2)	or 1 x 4-pole CA5 + 2 x 1-pole CA5 or CE5 (1)	or 1 x TEF5 + 2 x 1-pole CA5	+	1 to 2 x CAL5-11	-
			1 to 6 x CA5 1 to 5 x CE5 max. (2)	or 1 x 4-pole CA5 + 2 x 1-pole CA5 or CE5 (1)	or 1 x TEF5 + 2 x 1-pole CA5	+	1 x CAL5-11	-
UA95, UA110	3 0	0 0	1 to 6 x CA5 1 to 5 x CE5 max. (2)	or 1 x 4-pole CA5 + 2 x 1-pole CA5 or CE5 (1)	-	+	1 to 2 x CAL18-11 or 1 to 2 x CEL18	-
			1 to 6 x CA5 1 to 5 x CE5 max. (2)	or 1 x 4-pole CA5 + 2 x 1-pole CA5 or CE5 (1)	-	+	1 x CAL18-11 or 1 x CEL18	-
UA..RA contactors								
UA16-30-10RA	3 0	1 0	-	-	-	+	1 x CAL5-11	-
UA26-30-10RA	3 0	1 0	-	-	-	+	1 to 2 x CAL5-11	-
UA30-30-10RA	3 0	1 0	1 x CA5 1 x CE5	-	-	+	1 to 2 x CAL5-11	-
UA50-30-00RA	3 0	0 0	1 to 2 x CA5	-	-	+	1 to 2 x CAL5-11	-
UA63-30-00RA	3 0	0 0	1 to 2 x CE5	-	-	+	1 to 2 x CAL5-11	-
UA75-30-00RA	3 0	0 0	-	-	-	+	1 to 2 x CAL5-11	-
UA95-30-00RA	3 0	0 0	1 to 2 x CA5	-	-	+	1 to 2 x CAL18-11	-
UA110-30-00RA	3 0	0 0	1 to 2 x CE5	-	-	+	or 1 to 2 x CEL18	-
GA75, GAE75 contactors								
GA75	1 0	0 0	1 to 6 x CA5 1 to 5 x CE5 max. (2)	or 1 x 4-pole CA5 + 2 x 1-pole CA5 or CE5 (2)	or 1 x TEF5 + 2 x 1-pole CA5	+	1 to 2 x CAL5-11	or 1 x VE5-2 + 1 x CAL5-11
			1 to 6 x CA5 1 to 5 x CE5 max. (2)	or 1 x 4-pole CA5 + 2 x 1-pole CA5 or CE5 (2)	or 1 x TEF5 + 2 x 1-pole CA5	+	1 x CAL5-11	or 1 x VE5-2
GAE75	1 0	0 0	1 to 6 x CA5 1 to 5 x CE5 max. (2)	or 1 x 4-pole CA5 + 2 x 1-pole CA5 or CE5 (2)	or 1 x TEF5 + 2 x 1-pole CA5	+	1 x CAL5-11	or 1 x VE5-2
			1 to 6 x CA5 1 to 5 x CE5 max. (2)	or 1 x 4-pole CA5 + 2 x 1-pole CA5 or CE5 (2)	or 1 x TEF5 + 2 x 1-pole CA5	-	-	-

Notes regarding combination of CE5 with other accessories:

(1) The total number of N.O. or N.C. CE5 and other additional N.C. CA5 auxiliary contacts is limited to 3. CES auxiliary contacts not allowed in mounting position 5.

(2) The total number of N.O. or N.C. CE5 and other additional N.C. CA5 auxiliary contacts is limited to 5.

Function markers

Mounting piece



BA5-50

1SBC0513874FC001

BA5-50 Function markers

Description

Set of 50 function markers designed to be clipped onto the front face of devices. Details can be added to these markers using a ball point pen, indelible felt-tip pen or pentel white.

Self-adhesive labels (not supplied) can also be added to them.

Marker dimensions: 7 x 19 mm (0.276" x 0.748").

Ordering details

For contactors	Type	Order code	Pkg qty	Weight (1 pce) kg
UA, UA..RA and accessories GA75, GAE75	BA5-50	1SBN110000R1000	1	0.017

5

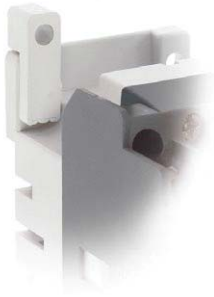

BP16

1SBC0596724FC002

BP16 Mounting piece

Description

Mounting piece for screw fixing (M4, not supplied) of UA, UA..RA series contactors indicated in the table below.

Easy handling of screwdrivers and screw driving.

Add-on mounting piece on contactor's rear face, offering a wide fixing facility.

Ordering details

For contactors	Type	Order code	Pkg qty	Weight (1 pce) kg
UA16, UA16..RA	BP16	1SBN111403R1000	100	0.141

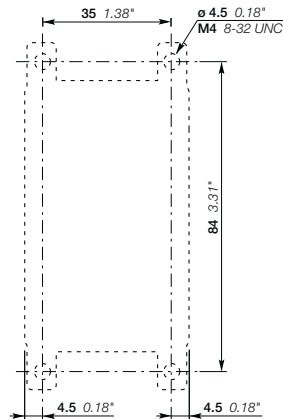

Drilling plan for UA16, UA16..RA contactors with BP16

1SBC101631S0201 - Rev. B

Surge suppressors for contactor coils

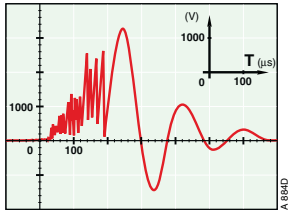

Description

The operation of inductive circuits causes overvoltages, in particular on opening of the contactor coil. The electromagnetic energy stored in the coil during contactor closing is restored on opening in the form of surges, the slope and amplitude of which may rise to several kilovolts. A number of drawbacks are observed ranging from interference on the electronic devices to breakdown of insulators and even destruction of certain sensitive components.

The graph opposite reproduces the oscillogram showing voltage discharges at the terminals of a 42 V / 50 Hz coil without peak clipping. The coil was switched by 8 series-connected poles of a contactor relay.

Following a burst of discharges with a very steep slope a damped oscillation emerges with a peak value of 3500 V.

Overvoltage Factor

The overvoltage factor k is defined as the ratio of the maximum overvoltage peak value \hat{U}_s to the peak value \hat{U}_c of the coil rated control voltage U_c :

$$k = \frac{\hat{U}_s \text{ max.}}{\hat{U}_c} \quad \text{in DC: } k = \frac{\hat{U}_s \text{ max.}}{U_c} \quad \text{or in AC: } k = \frac{\hat{U}_s \text{ max.}}{U_c \sqrt{2}}$$

For example the following is obtained for the above graph: $k = \frac{3500}{42 \sqrt{2}} \approx 60$

To reduce the harmful effects of these overvoltages, ABB has developed a range of surge suppressors designed to reduce the k factor defined above and to limit or even completely eliminate the high pre-damping voltage frequencies.

Each case is different, but the technical data tolerances and the generous sizing of parts have enabled us to reduce the number of variants.

We have chosen the following solutions: transient diodes, varistors and RC blocks.

Note: A varistor is a resistor whose value decreases to a very large extent when a certain voltage is applied at its terminals.



RV5/50



RC5-1/50

Ordering details

For contactors	Rated control circuit voltage U_c		Type	Order code	Pkg qty	Weight (1 pce) kg
	V	AC DC				
UA, UA..RA GA75, GAE75	24...50	● ●	RV5/50	1SBN050010R1000	2	0.015
	50...133	● ●	RV5/133	1SBN050010R1001	2	0.015
	110...250	● ●	RV5/250	1SBN050010R1002	2	0.015
	250...440	● ●	RV5/440	1SBN050010R1003	2	0.015
UA, UA..RA GA75	24...50	● -	RC5-2/50	1SBN050200R1000	2	0.015
	50...133	● -	RC5-2/133	1SBN050200R1001	2	0.015
	110...250	● -	RC5-2/250	1SBN050200R1002	2	0.015
	250...440	● -	RC5-2/440	1SBN050200R1003	2	0.015
GAE75	12...32	- ●	RT5/32	1SBN050020R1000	2	0.015
	25...65	- ●	RT5/65	1SBN050020R1001	2	0.015
	50...90	- ●	RT5/90	1SBN050020R1002	2	0.015
	77...150	- ●	RT5/150	1SBN050020R1003	2	0.015
	150...264	- ●	RT5/264	1SBN050020R1004	2	0.015

Surge suppressors for contactor coils

Technical data

Varistor	RV5/50	RV5/133	RV5/250	RV5/440
Rated control circuit voltage U_c	24...50 V AC 24...50 V DC	50...133 V AC 50...133 V DC	110...250 V AC 110...250 V DC	250...440 V AC 250...440 V DC
Residual overvoltage (clipping voltage)	132 V AC 132 V DC	270 V AC 270 V DC	480 V AC 480 V DC	825 V AC 825 V DC
Opening time growth factor	1.1...1.5			
Operating temperature	-20...+70 °C			
Connection to the coil terminals (parallel mounting)	Clip-on for both fixing and connection.			
Fixing	Clipped onto the top part of the contactor base without change in contactor overall dimensions.			
Advantages	High energy absorption: good damping - Unpolarized system.			
Drawback	Clipping as from Uvdr*, thus voltage front up to this point. *Uvdr = Varistor operating voltage (voltage dependent resistor), tolerance $\pm 10\%$.			

5

RC type	RC5-2/50	RC5-2/133	RC5-2/250	RC5-2/440
Rated control circuit voltage U_c	24...50 V AC			
Residual overvoltage (clipping voltage)	2 to 3 x U_c max.			
Opening time growth factor	1.2...1.3			
Operating temperature	-20...+70 °C			
Connection to the coil terminals (parallel mounting)	Clip-on for both fixing and connection.			
Fixing	Clipped onto the top part of the contactor base without change in contactor overall dimensions.			
Advantages	Very fast clipping - Attenuation of steep fronts and thus of high frequencies. No operating delays.			

Transil diode	RT5/32	RT5/65	RT5/90	RT5/150	RT5/264
Rated control circuit voltage U_c	12...32 V DC	25...65 V DC	50...90 V DC	77...150 V DC	150...264 V DC
Residual overvoltage (clipping voltage)	50 V DC	100 V DC	150 V DC	210 V DC	390 V DC
Opening time growth factor	1.5...3				
Operating temperature	-20...+70 °C				
Connection to the coil terminals (parallel mounting)	Clip-on for both fixing and connection.				
Fixing	Clipped onto the top part of the contactor base without change in contactor overall dimensions.				
Advantages	Good energy absorption - Unpolarized system - Simple, reliable system.				
Drawback	A certain delay on drop out which does not however reduce contactor breaking capacity.				

Wiring diagrams

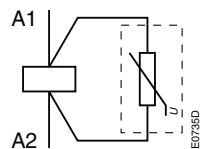

Varistor

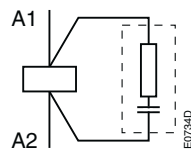

RC type

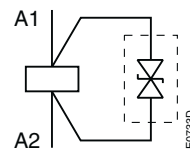

Transil diode

Dimensions

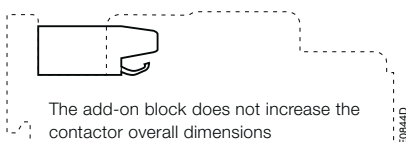

RV5, RC5, RT5

Interface relays



RA5-1

1SBC101003R0014

Description

RA5-1 interface relay is designed to receive 24 V DC signals delivered by PLC's or other sources with a low output power and to restore them with sufficient power to operate the coils of the relevant contactors. RA5-1 interface relay is made up of a miniature electromechanical relay equipped with a N.O. contact and with a low consumption 24 V DC coil.

The interface relay coil is controlled by the PLC while the N.O. contact ensures switching of the power contactor.

Coil switching gives rise to overvoltages which have adverse effects on the electronic devices, insulators and, more generally, on component lifetime. The RA5-1 is equipped with surge suppressors:

- on the 24 V DC relay coil via a diode,
- on the power contactor coil via a varistor.

Furthermore, the RA5-1 is protected against relay pole reversal by a diode inserted between the E1 and E2 input terminals.

Ordering details



For contactors	Coil voltages	Rated control circuit voltage Uc	Type	Order code	Pkg qty	Weight (1 pce)
	V 50/60 Hz	V DC				kg
UA, UA..RA	24...250	24	RA5-1	1SBN060300R1000	1	0.050
GA75			RA5-1	1SBN060300T1000	10	0.050

Interface relays

Technical data

Type	RA5-1
Utilization characteristics according to IEC	
Standards	IEC 60255-5
Rated insulation voltage U_i acc. to IEC 60947-4-1	250 V AC
Ambient air temperature	
In free air operation	at $U_c = 24$ V DC (between E1 and E2) -25...+70 °C
Storage	from 0.85 to 1.1 x U_c -25...+55 °C
Storage	-40...+70 °C
Climatic withstand	Complies with that of associated contactors
Maximum operating altitude	3000 m
Mounting positions	No limitation
Fixing	Using the contactor A1 and A2 terminal connecting parts

Connecting characteristics

Connection capacity (min. ... max.)	
 Rigid solid	1 x 1...4 mm ² 2 x 1...4 mm ²
 Flexible with ferrule	1 x 0.75...2.5 mm ² 2 x 0.75...2.5 mm ²
 Lugs	L < 8 mm l > 3.5 mm
Tightening torque	
Recommended	1 Nm
Max.	1.2 Nm
Degree of protection	
acc. to IEC 60947-1 / EN 60947-1 and IEC 60529 / EN 60529	Protection against direct contact in acc. with EN 50274 RA5-1 wired and mounted on the associated contactor
Screw terminals	
All terminals	Delivered in open position, screws of unused terminals must be tightened M3.5
Screwdriver type	
	Flat Ø 5.5 / Pozidriv 2

Working data

Surge suppression	
For contactor coil	Varistor
For interface relay coil	Diode
Protection against polarity reversal between terminals E1 and E2	
	Diode
Interface relay operating time	
	Closing and drop-out ≤ 10 ms
Total operating time, interface relay + contactor	
Between energization and:	N.O. contact closing 20...37 ms N.C. contact opening 17...32 ms
Between de-energization and:	N.O. contact opening 17...25 ms N.C. contact closing 20...28 ms

Electrical input data

Control voltage (E1 and E2 terminals) U_c	
Rated value	24 V DC
Max. range at ambient temperature 20 °C	19...30 V DC
Max. consumption for $U_c = 24$ V DC, $\theta = 20$ °C	
	0.3 W
"0" status (relay open)	for U_c ≤ 2.4 V DC for I_c < 1 mA
"1" status (relay closed)	for U_c ≥ 19 V DC
Max. short supply interruption immunity time	
	2 ms

Electrical output data

Switching voltage (A0 and A2 terminals)	
	≤ 250 V AC
Electrical durability	
Number of operating cycles	2 millions (600 cycles/h) on UA16(RA) ... UA75(RA), GA75, GAE75 contactors 0.5 million (600 cycles/h) on UA95(RA) and UA110(RA) contactors

Connection

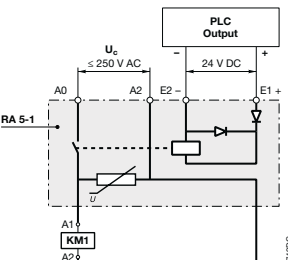
	<p>The "E1+" and "E2-" input terminals must be connected, according to their polarity, to the PLC output.</p> <p>The RA5-1 is equipped with two terminal pads for connection to the A1 and the A2 terminals of the contactor coil.</p> <p>This coil is supplied between the A0 and the A2 terminals of the RA 5-1.</p> <p>Mounting: terminals pads clamped inside the contactor coil terminals.</p>
--	---

Mechanical latching units



WB75-A

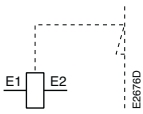

Terminal marking

Description

For converting standard contactors into latched contactors.

The WB75-A block contains a mechanical latching device with electromagnetic impulse unlatching (AC or DC) or manual unlatching.

Captive screw type connecting terminals, built-in cable clamps, M3.5 (+,-) pozidriv 2 screw with screw-driver guidance; delivered untightened and protected against accidental direct contact.

Operation

After closing, the contactor continues to be held in the closed position by the latching mechanism should the supply voltage fail at the contactor coil terminals.

Contactor opening can be controlled:

- electrically by an impulse (AC or DC) on the WB75-A block coil.
(the coil is not designed to be permanently energized)
- manually by pressing the pushbutton on the front face of the WB75-A block.

Mounting

The WB75-A block is clipped onto the front face of the 1-stack contactor where it takes up two slots. The two other slots may accept CA5... single pole auxiliary contacts (1 block on each side of the mechanical latch).

Ordering details

For contactors	Rated control circuit voltage U_c		Type	Order code	Pkg qty	Weight (1 pce)
	V 50 Hz or DC	V 60 Hz				
UA16 ... UA75, GA75, GAE75	24	24...28	WB75-A	FPTN372726R1001	1	0.120
	42	42...48	WB75-A	FPTN372726R1002	1	0.120
	48	48...55	WB75-A	FPTN372726R1003	1	0.120
	110	110...127	WB75-A	FPTN372726R1004	1	0.120
	220...230	220...255	WB75-A	FPTN372726R1006	1	0.120
	230...240	230...277	WB75-A	FPTN372726R1005	1	0.120
	380...415	380...440	WB75-A	FPTN372726R1007	1	0.120
	415...440	440...480	WB75-A	FPTN372726R1008	1	0.120

Mechanical latching units





Technical data

Type	WB75-A
------	--------

Utilization characteristics according to IEC

Rated insulation voltage U_i acc. to IEC 60947-1	690 V
Max. electrical impulse time	
On AC coil (with load factor 5 %)	20 s
On DC coil (with load factor 3 %)	8 s
Min. electrical impulse time	
For latching (energizing of the contactor coil)	AC 50 ms (UA, GA contactors) DC 50 ms (GAE contactors)
For pull-out (energizing of the WB block coil)	AC 30 ms (UA, GA contactors) DC 50 ms (GAE contactors)
Coil operating limits	AC or DC supply 0.85...1.1 x U_c
AC control voltage 50/60 Hz	
Rated control circuit voltage U_c	24...480 V AC
Coil consumption	Average pull-in value 90 VA Average holding value 60 VA
DC control voltage	
Rated control circuit voltage U_c	24...440 V DC
Coil consumption	Average pull-in value 110 W Average holding value 110 W
Operating time	
On contactor closing (latching) Between coil energization and:	N.O. contact closing No difference with the operation of a contactor without mechanical latching unit N.C. contact opening No difference with the operation of a contactor without mechanical latching unit
On contactor opening (unlatching) Between WB coil energization and:	N.O. contact opening 5...25 ms N.C. contact closing 7...28 ms
Mechanical durability	Number of operating cycles 1 million operating cycles
Max. switching frequency	3600 cycles/h with on-load factor of 8 %

Connecting characteristics

Connection capacity (min. ... max.)		
 Rigid solid	1 x	1...4 mm ²
 Flexible with ferrule	2 x	1...4 mm ²
 Flexible with ferrule	1 x	0.75...2.5 mm ²
 Flexible with ferrule	2 x	0.75...2.5 mm ²
 Lugs	L <	8 mm
	L >	3.5 mm
Tightening torque	Recommended	1 Nm
	Max.	1.2 Nm
Screw terminals	Delivered in open position, screws of unused terminals must be tightened	
All terminals	M3.5	
Screwdriver type	Flat Ø 5.5 / Pozidriv 2	

Additional terminal blocks and other accessories



LD75

Terminal blocks

Description

The LD terminal blocks are designed to increase the connecting capacity of the contactor on which they are fitted and for preparation of the wiring before final connection on the contactor.





The LD blocks are 3-pole terminal blocks with tunnel terminals.

The LD75 terminal blocks are fixed in the 3 independent slots located above the built-in connectors.

Ordering details

For contactors	Type	Order code	Pkg qty	Weight (1 pce) kg
UA50(RA) ... UA75(RA)	LD75	1SBN073508R1000	1	0.115

Technical data

Types	LD75
Rated insulation voltage Ui acc. to IEC 60947-4-1 acc. to UL / CSA	690 V 600 V
Main terminals	 Screw terminals with single connector 10x11 mm
Connection capacity (min. ... max.)	
 Rigid Solid ($\leq 4 \text{ mm}^2$) } 1 x 6...50 mm ²	
 Stranded ($\geq 6 \text{ mm}^2$) } 2 x 6...25 mm ²	
 Flexible with ferrule 1 x 6...35 mm ²	
 Bars 2 x 6...16 mm ²	
Tightening torque	10 mm 4 Nm
Degree of protection acc. to IEC 60947-1 / EN 60947-1 and IEC 60529 / EN 60529	IP10
Screw terminals	Delivered in closed position M6
Screwdriver type	pozidriv 2

Note: The utilization of LD additional terminal blocks leaves the possibility to connect the following cables directly into the contactor main terminals.

	LD75
Possible cross section of rigid cable in the contactor terminals	50 mm ²

Terminal enlargements

Description

Enlargement pieces designed to increase the width of the contactor terminal pads in order to allow larger connections to be mounted.

Sets containing 3 tin plated copper bars fixed by an isolating spacer.

Ordering details

For contactors	Dimensions		Type	Order code	Pkg qty	Weight (1 pce) kg
	hole Ø mm	bar mm				
UA95, UA110	6.5	15 x 3	LW110	1SFN074307R1000	1	0.100



LW

1SFT198000-011C3

Terminals for control lead connections



LK75-L



LK75-F

Description

Terminals designed to connect the control conductors to the main poles of the UA and GA contactors and derivative versions.

Accessories clipped into the slots placed above each power terminal connector.

The LK75 are fitted with a pin designed to hold them in place until the connector has been fully clamped with its power cable.

- Degree of protection IP20
- Connecting terminal delivered in open position: cable clamp and M3.5 (+, -) pozidriv 2 screw.
- Cable cross-sectional area:
 - 1 or 2 rigid conductors1...4 mm²
 - 1 or 2 flexible conductors with cable end0.75...2.5 mm²
- Tightening torque for the LK screw:
 - recommended.....1.00 Nm
 - maxi.....1.20 Nm

Ordering details

For contactors	Type	Order code	Pkg qty	Weight (1 pce) kg
Right and left on: UA50(RA) ... UA75(RA) GA75, GAE75	LK75-L	1SBN073552R1003	2	0.006
Opposite on: UA50(RA) ... UA75(RA) GA75, GAE75	LK75-F	1SBN073552R1002	2	0.006

Note: The LK terminals provided for the UA contactors can be used with the AM types.

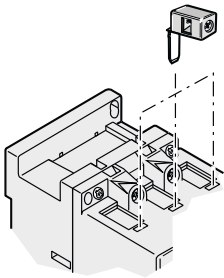

LK positioning

Main dimensions mm, inches

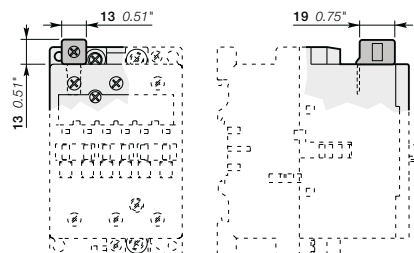

LK75-L

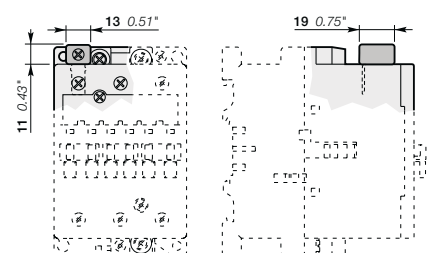

LK75-F

Contactors coils and main contact sets



ZA16

1SBG5738602F0302

Contactors coils

Ordering details

For contactors	Rated control circuit voltage Uc		Type	Order code	Pkg qty	Weight (1 pce) kg
	V 50 Hz	V 60 Hz				
UA16, UA16..RA	24	24	ZA16	1SBN151410R8106	1	0.093
	48	48	ZA16	1SBN151410R8306	1	0.093
	110	110...120	ZA16	1SBN151410R8406	1	0.093
	220...230	230...240	ZA16	1SBN151410R8006	1	0.093
	230...240	240...260	ZA16	1SBN151410R8806	1	0.093
	380...400	400...415	ZA16	1SBN151410R8506	1	0.093
	400...415	415...440	ZA16	1SBN151410R8606	1	0.093
UA26, UA30, UA26..RA, UA30..RA	24	24	ZA40	1SBN152410R8106	1	0.148
	48	48	ZA40	1SBN152410R8306	1	0.148
	110	110...120	ZA40	1SBN152410R8406	1	0.148
	220...230	230...240	ZA40	1SBN152410R8006	1	0.148
	230...240	240...260	ZA40	1SBN152410R8806	1	0.148
	380...400	400...415	ZA40	1SBN152410R8506	1	0.148
	400...415	415...440	ZA40	1SBN152410R8606	1	0.148
UA50 ... UA75 UA50..RA ... UA75..RA GA75	24	24	ZA75	1SBN153510R8106	1	0.166
	48	48	ZA75	1SBN153510R8306	1	0.166
	110	110...120	ZA75	1SBN153510R8406	1	0.166
	220...230	230...240	ZA75	1SBN153510R8006	1	0.166
	230...240	240...260	ZA75	1SBN153510R8806	1	0.166
	380...400	400...415	ZA75	1SBN153510R8506	1	0.166
	400...415	415...440	ZA75	1SBN153510R8606	1	0.166
UA95, UA110 UA95..RA, UA110..RA	24	24	ZA110	1SFN154310R8106	1	0.170
	48	48	ZA110	1SFN154310R8306	1	0.170
	110	110...120	ZA110	1SFN154310R8406	1	0.170
	220...230	230...240	ZA110	1SFN154310R8006	1	0.170
	230...240	240...260	ZA110	1SFN154310R8806	1	0.170
	380...400	400...415	ZA110	1SFN154310R8506	1	0.170
	400...415	415...440	ZA110	1SFN154310R8606	1	0.170

5

Main contact sets

Description

The contact sets for 3-pole contactors consists of six fixed contacts, three moving contacts, springs and the required screws.

Ordering details

For contactors	Type	Order code	Pkg qty	Weight (1 pce) kg
UA50	ZLU50	1SBN163502R1000	1	0.115
UA63	ZLU63	1SBN163702R1000	1	0.145
UA75	ZLU75	1SBN164102R1000	1	0.145
UA95	ZLU95	1SFN164302R1000	1	0.190
UA110	ZLU110	1SFN164502R1000	1	0.190

Accessories for EK550, EK1000 4-pole contactors

Auxiliary contact blocks	5/400
Mechanical interlock units, terminal shrouds and connection sets	5/404
Surge suppressors for contactor coils	5/406
Main contact sets - Arc chutes	5/408
Contactor coils	5/409
Voltage code table	5/410

Auxiliary contact blocks

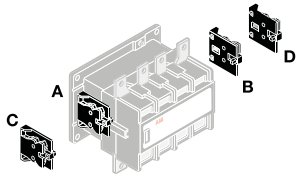

Mounting positions of the CAL16-11

EK550, EK1000

Description

The auxiliary contact blocks are used for the operation of auxiliary circuits and control circuits.



Types of auxiliary contact blocks for standard industrial environments:

- CAL instantaneous with N.O. + N.C. contacts
- CCL N.O. leading contact + N.C. lagging contact.

The auxiliary contact blocks are equipped with screw type connecting terminals delivered open, protected against accidental direct contact, and bear the corresponding function marking.

Mounting: Screwed onto the right and / or lefthand side of the EK550, EK1000 contactors.

Ordering details

For contactors	Number of blocks	Auxiliary contacts	Type	Order code	Pkg qty	Weight (1 pce)
		 				kg
2-pole auxiliary contacts N.O. + N.C.						
EK	1	1 1 - -	CAL16-11A	SK829002-A	1	0.050
	1	1 1 - -	CAL16-11B	SK829002-B	1	0.050
	1	1 1 - -	CAL16-11C	SK829002-C	1	0.050
	1	1 1 - -	CAL16-11D	SK829002-D	1	0.050
	1	1 - - 1	CCL16-11E (1)	SK829002-E	1	0.050

(1) Mounting of CCL16-11E blocks does not allow an additional second block to be added on top of it. All DC operated EK contactors are equipped with one CCL16-11E on the right side.

Auxiliary contact blocks

Technical data

Types	2-pole CAL 16-11, 2-pole CCL 16-11
-------	------------------------------------

Contact utilization characteristics according to IEC







Standards	IEC 60947-5-1 and EN 60947-5-1	
Rated insulation voltage U_i acc. to IEC 60947-5-1	690 V	
Rated operational voltage U_e max.	24...690 V	
Conventional thermal current I_{th} - $\theta \leq 40$ °C	10 A	
Rated frequency (without derating)	50/60 Hz	
le / Rated operational current AC-15		
acc. to IEC 60947-5-1	24-127 V	6 A
	220-240 V	6 A
	380-440 V	4 A
	500-690 V	1 A
Making capacity acc. to IEC 60947-5-1	10 x I_e AC-15	
Breaking capacity acc. to IEC 60947-5-1	10 x I_e AC-15	
le / Rated operational current DC-13		
acc. to IEC 60947-5-1	24 V DC	6 A
	48 V DC	6 A
	72 V DC	4 A
	125 V DC	1.8 A
	250 V DC	0.6 A
Short-circuit protection device gG type fuse	10 A	
Rated short-time withstand current I_{cw}	for 1.0 s	50 A
$\theta = 40$ °C	for 0.1 s	100 A
Minimum switching capacity	0.25 VA / 12 V or 0.25 VA / 5 mA	
with failure rate acc. to IEC 60947-5-4		
Power dissipation per pole at 6 A	0.2 W	
Mechanical durability	Number of operating cycles	10 millions operating cycles
	Max. switching frequency	3600 cycles/h
Electrical durability	Number of operating cycles	see "Electrical durability" curves
	Max. switching frequency	1200 cycles/h

5

Contact utilization characteristics according to UL / CSA

Max. operational voltage	600 V
Pilot duty	A600

Connecting characteristics

Connection capacity (min. ... max.)		
	Rigid solid	1 x 0.5...2.5 mm ²
	Flexible with ferrule	2 x 0.5...2.5 mm ²
		1 x 0.5...2.5 mm ²
	Flexible with insulated ferrule	2 x 0.5...2.5 mm ²
		1 x 0.5...1.5 mm ²
	Lugs	L ≤ 8 mm
		L > 3.7 mm
Tightening torque	Recommended	1.00 Nm
	Max.	1.20 Nm
Degree of protection		IP20
acc. to IEC 60947-1 / EN 60947-1 and IEC 60529 / EN 60529		
Screw terminals	Delivered in open position, screws of unused terminals must be tightened	
All terminals	M3.5	
Screwdriver type	Pozidriv 2	

Auxiliary contacts

Electrical durability

Electrical Durability for AC-15 Utilization Category

AC-15 utilization category according to IEC 60947-5-1 / EN 60947-5-1:

- making current: $10 \times I_e$ with $\cos \varphi = 0.7$ and U_e
- breaking current: I_e with $\cos \varphi = 0.4$ and U_e .

This curve represents the electrical durability of the auxiliary contacts in relation to the breaking current.

The curve has been drawn for resistive and inductive loads up to 690 V, 40...60 Hz.

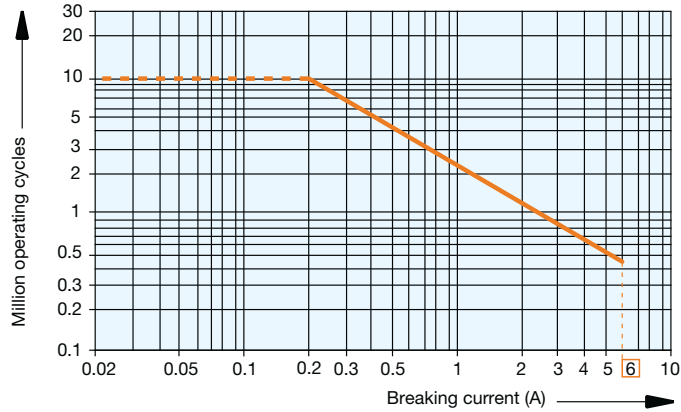

2-pole CAL16... and CCL16... auxiliary contact blocks

Electrical Durability for DC-13 Utilization Category

DC-13 utilization category according to IEC 60947-5-1 / EN 60947-5-1:

- making and breaking current = I_e with U_e value.

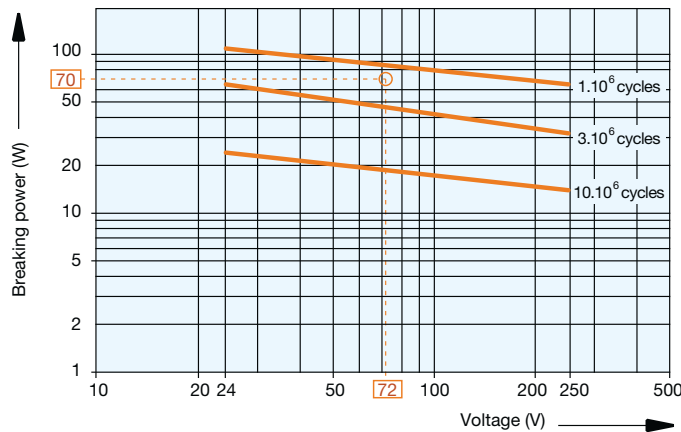

2-pole CAL16... and CCL16... auxiliary contact blocks

Example:

Control of d.c. electro-magnet: U_e voltage = 72 V d.c. and breaking power = 70 W.

On the opposite curve at intersection "O" 72 V / 70 W the corresponding value for the electrical durability is approximately $2 \cdot 10^6$ cycles.

Add-on auxiliary contacts

Terminal marking and positioning

2-pole auxiliary contacts



CAL16-11A



CAL16-11B



CAL16-11C



CAL16-11 D



CAL16-11E

Mechanical interlock units, terminal shrouds and connection sets



Mechanical interlock units

Description

The mechanical interlock unit prevents one of the contactors from closing as long as the other contactor is closed.

VH800 interlock unit is used for the mechanical interlocking of two horizontal mounted EK550, EK1000 contactors. Mounting plate is included.

Ordering details

For contactors	Type	Order code	Pkg qty	Weight (1 pce) kg
Mechanical interlock unit for two horizontal mounted contactors				
EK550, EK1000	VH800	SK829070-F	1	6.000

Terminal shrouds

Description

The use of terminal shrouds on the main terminals of EK contactors is required in electrical panels or cubicles to be built in compliance with the rules for protection against direct contact with live parts in acc. with EN 50274.

On EK550, EK1000 contactors:

- The auxiliary contact blocks and coils are designed to provide an IP20 degree of protection
- The main terminals, equipped with lugs or connectors, can be protected against accidental direct contact after wiring (EN 50274) by the addition of terminal shrouds (see table below).

Each terminal shroud protects all the terminals on one side of the contactor. Two terminal shrouds should be provided for each separate contactor.

Ordering details

For contactors	Type	Order code	Pkg qty	Weight (1 pce) kg
EK550	LT550-EK	SK178001-LB	1	0.190
EK1000	LT1000-EK	SK178001-MB	1	0.200

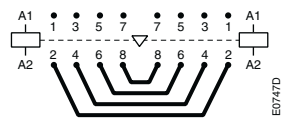

BSS550, BSS1000

Connection sets

Description

Connection between the main poles of two 4-pole contactors mounted side by side so that they operate as source reversing contactors.

These sets are made up of four downstream connections.

BSS550, BSS1000 – Bare, solid copper bars.

Ordering details

For contactors	Type	Order code	Pkg qty	Weight (1 pce) kg
Mechanical and electrical interlock units for two horizontal mounted contactors				
EK550	BSS550	SK829090-E	1	3.300
EK1000	BSS1000	SK829090-H	1	5.500

Mechanical interlocks units

Mechanical and electrical interlock units





Technical data

Types	VH145	VH300
-------	-------	-------

Contact utilization characteristics according to IEC

Standards	IEC 60947-5-1 and EN 60947-5-1	
Rated insulation voltage U_i acc. to IEC 60947-5-1	690 V	
Rated insulation voltage U_i acc. to UL / CSA	600 V	
Rated operational voltage U_e max.	24 ... 690 V	
Conventional thermal current I_{th} - $\theta \leq 40$ °C	10 A	
I_e / Rated operational current AC-15		
acc. to IEC 60947-5-1	24-127 V 50/60 Hz	6 A
	220-240 V 50/60 Hz	6 A
	380-440 V 50/60 Hz	4 A
	500-690 V 50/60 Hz	1 A
Making capacity acc. to IEC 60947-5-1	10 x I_e AC-15	
Breaking capacity acc. to IEC 60947-5-1	10 x I_e AC-15	
I_e / Rated operational current DC-13		
acc. to IEC 60947-5-1	24 V DC	6 A
	48 V DC	6 A
	72 V DC	4 A
	125 V DC	1.8 A
	250 V DC	0.6 A
Short-circuit protection device - gG type fuse	10 A	
Rated short-time withstand current I_{cw}	for 1.0 s	100 A
$\theta = 40$ °C	for 0.1 s	140 A
Power dissipation per pole at 6 A	0.15 W	
Mechanical durability	1 million operating cycles	
Number of operating cycles	1 million operating cycles	
Max. switching frequency	600 cycles/h	

Connecting characteristics

Connection capacity (min. ... max.)		
 Rigid solid	1 x	1 ... 2.5 mm ²
 Flexible with ferrule	2 x	1 ... 2.5 mm ²
 Flexible with ferrule	1 x	0.75 ... 2.5 mm ²
 Flexible with ferrule	2 x	0.75 ... 2.5 mm ²
 Bars or lugs	L <	8 mm
	I >	3.7 mm
Tightening torque		
Recommended	1 Nm	
Max.	1.2 Nm	
Degree of protection	IP20	
acc. to IEC 60947-1 / EN 60947-1 and IEC 60529 / EN 60529		
Screw terminals	Delivered in open position, screws of unused terminals must be tightened	
All terminals	M3.5	
Screwdriver type	Flat Ø 5.5 / Pozidriv 2	

Technical note: when, during switching, the arc time is estimated to more than 40 ms, the closing signal of one of the two contactors must be delayed with respect to the opening signal of the other contactor in order to prevent a short-circuit.

Use a TP40 pneumatic timer or TE5S electronic timer with time lapse, as applicable.

Surge suppressors for contactor coils

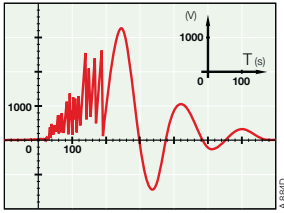

5

RC-EH

Description

The operation of inductive circuits causes overvoltages, in particular on opening of the contactor coil. The electromagnetic energy stored in the coil during contactor closing is restored on opening in the form of surges, the slope and amplitude of which may rise to several kilovolts. A number of drawbacks are observed ranging from interference on the electronic devices to breakdown of insulators and even destruction of certain sensitive components.

The graph opposite reproduces the oscillogram showing voltage discharges at the terminals of a 42 V / 50 Hz coil without peak clipping. The coil was switched by 8 series-connected poles of a contactor relay.

Following a burst of discharges with a very steep slope a damped oscillation emerges with a peak value of 3500 V.

Overvoltage Factor

The overvoltage factor k is defined as the ratio of the maximum overvoltage peak value \hat{U}_s to the peak value \hat{U}_c of the coil rated control voltage U_c :

$$k = \frac{\hat{U}_s \text{ max.}}{\hat{U}_c} \quad \text{in DC: } k = \frac{\hat{U}_s \text{ max.}}{U_c} \quad \text{or in AC: } k = \frac{\hat{U}_s \text{ max.}}{U_c \sqrt{2}}$$

For example the following is obtained for the above graph: $k = \frac{3500}{42 \sqrt{2}} \approx 60$

To reduce the harmful effects of these overvoltages, ABB has developed a range of surge suppressors designed to reduce the k factor defined above and to limit or even completely eliminate the high pre-damping voltage frequencies.

Each case is different, but the technical data tolerances and the generous sizing of parts have enabled us to reduce the number of variants.

We have chosen the following solutions: transil diodes, varistors and RC blocks.

Note: A varistor is a resistor whose value decreases to a very large extent when a certain voltage is applied at its terminals.

Ordering details

For contactors	Rated control circuit voltage U_c		Type	Order code	Pkg qty	Weight (1 pce) kg
	V	AC DC				
EK550, EK1000	48...110	● -	RC-EH800/110	SK829007-C	1	0.015
EK550, EK1000	24...125	- ●	RC-EH800/110	SK829007-C	1	0.015
EK550, EK1000	220...600	● -	RC-EH800/600	SK829007-D	1	0.015

Surge suppressors for contactor coils

Technical data

Varistor + RC	RC-EH800/110	RC-EH800/600
Rated control circuit voltage U_c	48...110 V AC 24...125 V DC	220...600 V AC -
Residual overvoltage (clipping voltage)	205 V AC 205 V DC	1100 V AC -
Opening time growth factor	1.1 ... 1.15	-
Operating temperature	-20 ... +70 °C	-
Connection to the coil terminals (parallel mounting)	Flexible, accessible leads, equipped with forked lugs	
Fixing	Glued to the top part of the contactor base	
Advantages	<ul style="list-style-type: none"> - High energy absorption: good damping - Unpolarized system - The RC system damps the voltage front under the U_{vdr} (1) threshold. 	

(1) U_{vdr} = Varistor operating (voltage dependant resistor), tolerance ± 10 %.

Wiring diagrams

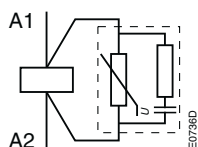

Varistor + RC

Main dimensions mm

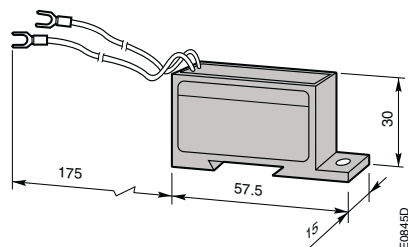

RC-EH

Main contact sets

Arc chutes



1SFC96E73F004

KZK

Main contact sets

Description

The contact sets for 4-pole contactors consist of eight fixed contacts, four moving contacts, springs and the necessary screws. In addition, the sets include four moving arcing contacts for EK550, EK1000 contactors.

Ordering details

For contactors	Type	Order code	Pkg qty	Weight (1 pce) kg
EK550	KZK550	SK827204-B	1	2.400
EK1000	KZK1000	SK827204-F	1	3.000

Arc chutes

Description

The arc chutes sets for EK 4-pole contactors contain 8 pieces.

Ordering details

For contactors	Type	Order code	Pkg qty	Weight (1 pce) kg
EK550	KWK550	5223351-Z	1	3.170
EK1000	KWK1000	5223351-AN	1	3.170

Contactors coils



KH300

1SBC273819FC0002

For AC operated coil

Description

Coils for EK550, EK1000 - AC operated.

Ordering details

For contactors	Rated control circuit voltage U_c (1)		Type	Order code	Pkg qty	Weight (1 pce) kg
	V 50 Hz	V 60 Hz				
EK550, EK1000	48	-	KH800	SK828100-AD	1	0.950
	110	110...120	KH800	SK828100-EF	1	0.950
	110...115	115...127	KH800	SK828100-EG	1	0.950
	220	220...240	KH800	SK828100-EL	1	0.950
	220...230	230...255	KH800	SK828100-EM	1	0.950
	380	380...415	KH800	SK828100-EP	1	0.950
	380...400	400...440	KH800	SK828100-ER	1	0.950
	400...415	-	KH800	SK828100-AR	1	0.950

(1) Other control voltages, see voltage code table.

For DC operated coil

Description

Coils for EK550, EK1000 - DC operated with sets including a DC coil, an economy resistor and a insertion contact.

Ordering details

For contactors	Rated control circuit voltage U_c (1)	Type	Order code	Pkg qty	Weight (1 pce) kg
	V DC				
EK550, EK1000	24	KP800	SK828150-DB	1 set	1.060
	36	KP800	SK828150-DC	1 set	1.060
	48	KP800	SK828150-DD	1 set	1.060
	60	KP800	SK828150-DT	1 set	1.060
	75	KP800	SK828150-DG	1 set	1.060
	110	KP800	SK828150-DE	1 set	1.060
	125	KP800	SK828150-DU	1 set	1.060
	220	KP800	SK828150-DF	1 set	1.060

(1) Other control voltages, see voltage code table.

Voltage code table

The below tables indicate the available coil voltages and corresponding digits for order codes. When placing an order, please give the order code. Select a standard contactor from ordering detail pages. Change the **coil voltage code** in the order code according to the table below. Example: for contactor AF400-30-11 and coil 100...250 V 50/60 Hz, the order code is 1SFL577001R7011.

AF09 ... AF370 3-pole contactors AF09 ... AF370 4-pole contactors

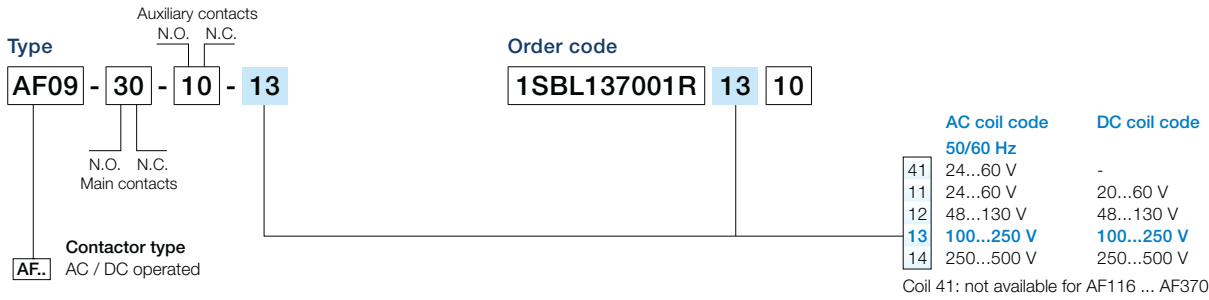

AF116 ... AF370 3-pole contactors with built-in PLC interface

	AC coil code 50/60 Hz	DC coil code
33	100...250 V	100...250 V
34	250...500 V	250...500 V

AF400 ... AF2650 3-pole contactors

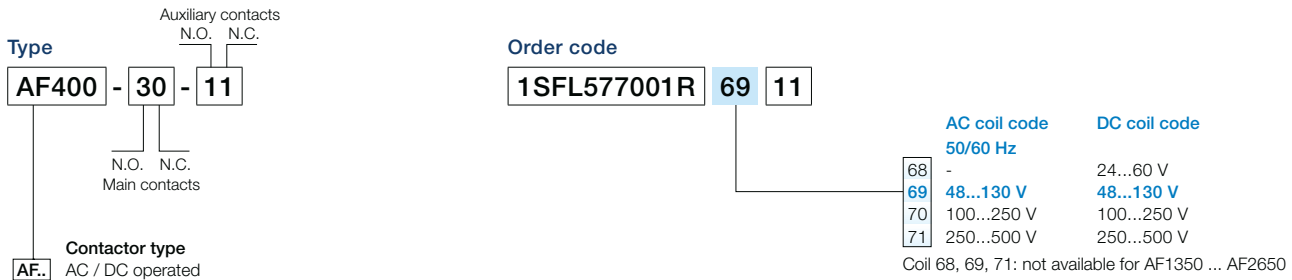

AF09 ... AF38 3- and 4-pole contactors - low consumption

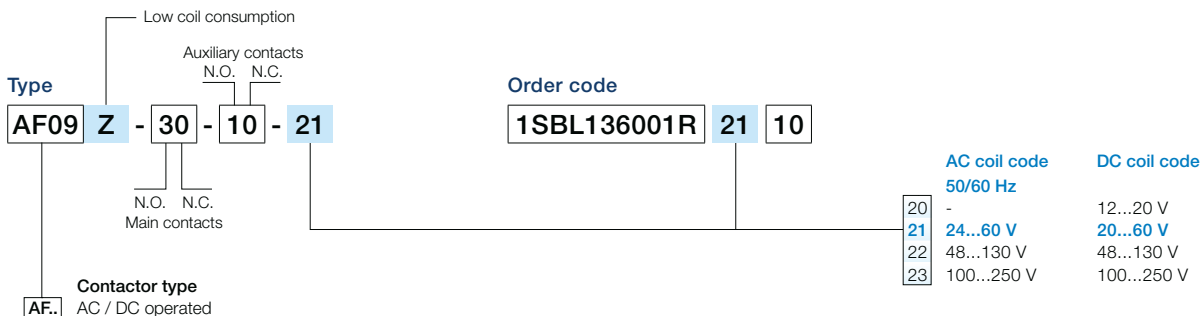

Voltage code table

NF contactor relays



NF contactor relays with overlapping of lagging / leading contacts

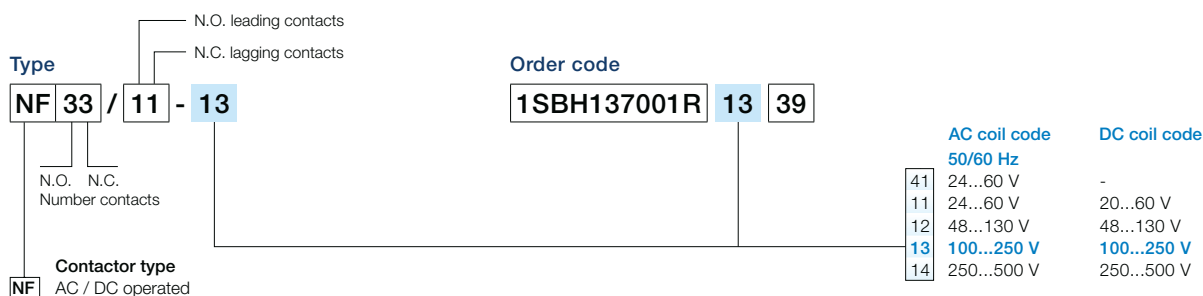

NF contactor relays - low consumption

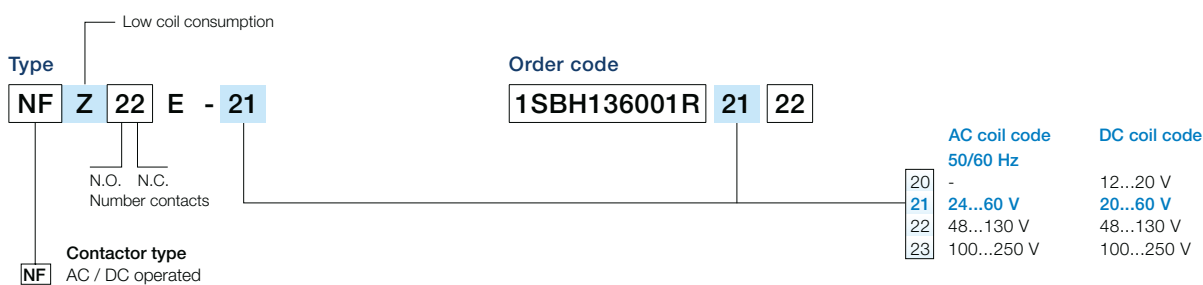

NF contactor relays with overlapping of lagging / leading contacts - low consumption

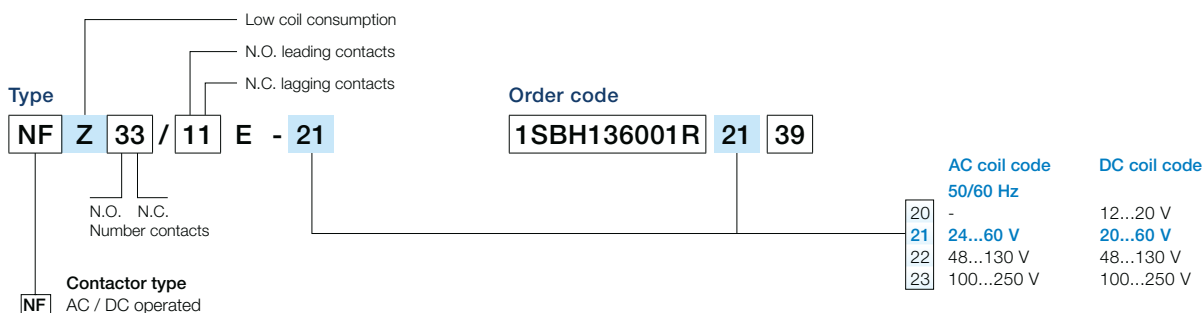

Voltage code table

UA, UA..RA contactors GA contactors

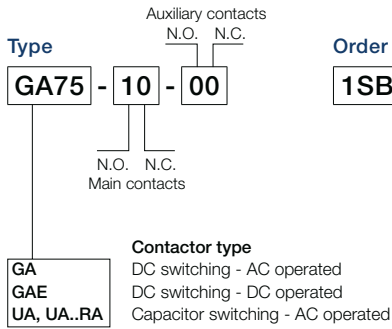

Order code

1SBL411025R 82 00

Contactors: UA, UA..RA, GA AC coil code

	50 Hz	60 Hz
81	24 V	24 V
16	26 V	28 V
17	28 V	32 V
82	42 V	42 V
20	42 V	48 V
83	48 V	48 V
73	60 V	60 V
74	100 V	100...110 V
26	105 V	110...127 V
84	110 V	110...120 V
89	110...115 V	115...127 V
29	120 V	140 V
30	125...127 V	150 V
34	175 V	208 V
36	190 V	220 V
40	210 V	240 V
80	220...230 V	230...240 V
88	230...240 V	240...260 V
42	230...240 V	277 V
85	380...400 V	400...415 V
86	400...415 V	415...440 V
50	400 V	440 V
51	400...415 V	480 V
87	415...440 V	440...460 V
53	440 V	500 V
55	500 V	600 V
56	550 V	-
58	660...690 V	-
59	-	690 V

Codes in bold for dual frequency coils.

Contactors: GAE DC coil code

80	12 V
81	24 V
82	42 V
83	48 V
21	50 V
84	60 V
85	75 V
86	110 V
87	125 V
88	220 V
89	240 V
38	250 V

EK550, EK1000 contactors

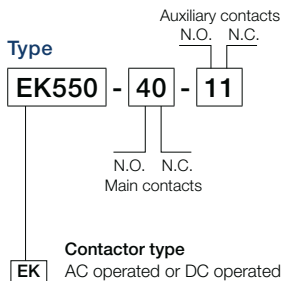

Order code

SK827041 - AD

AC coil code

	50 Hz	60 Hz
AD	48 V	-
AE	-	110 V
AF	110 V	120 V
AG	127 V	-
AZ	-	208 V
AH	190 V	220 V
AK	-	240 V
AL	220...230 V	240 V
AM	230...240 V	-
AN	-	380 V
AP	380...400 V	440 V
AR	400...415 V	-
AS	-	480 V
AT	440 V	-
AU	500 V	-
AV	-	600 V

Dual frequency coil code

	50 Hz	60 Hz
EF	110 V	110...120 V
EG	110...115 V	115...127 V
EL	220 V	220...240 V
EM	220...230 V	230...255 V
EP	380 V	380...415 V
ER	380...400 V	400...440 V

2 auxiliary contact blocks maximum per contactor, ambient temperature ≤ 55 °C and mounting positions 2 and 6 excluded.

DC coil code

DB	24 V
DC	36 V
DD	48 V
DT	60 V
DG	75 V
DE	110 V
DU	125 V
DF	220 V

Voltage code table

GAF185 ... GAF300 contactors

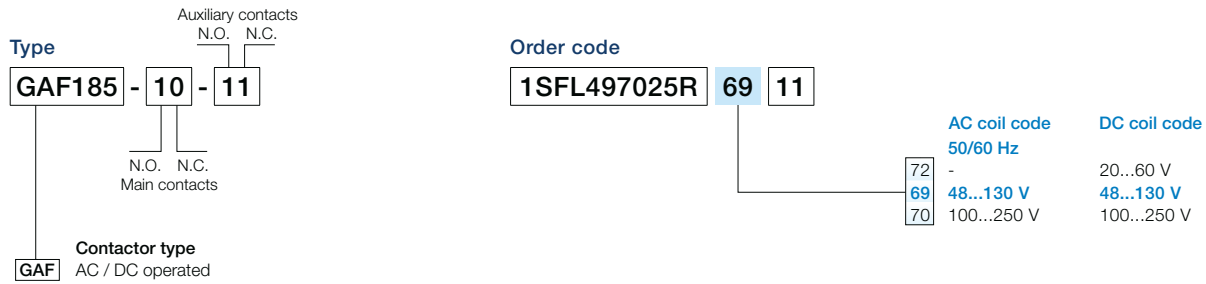

GAF460 ... GAF1250 contactors

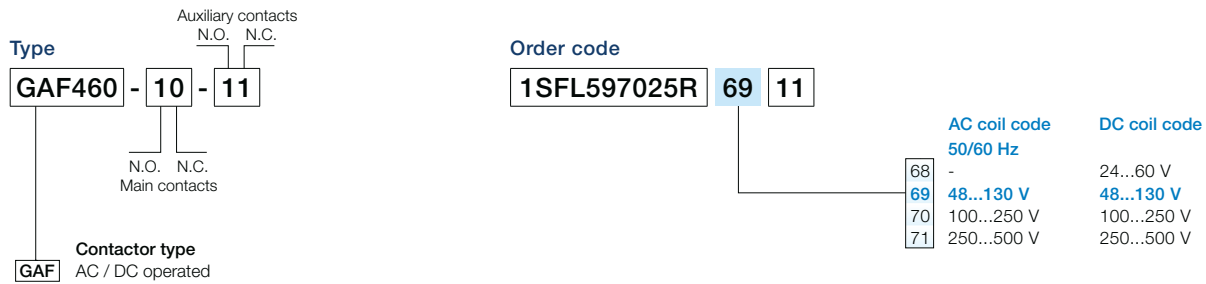

GAF1650, GAF2050 contactors

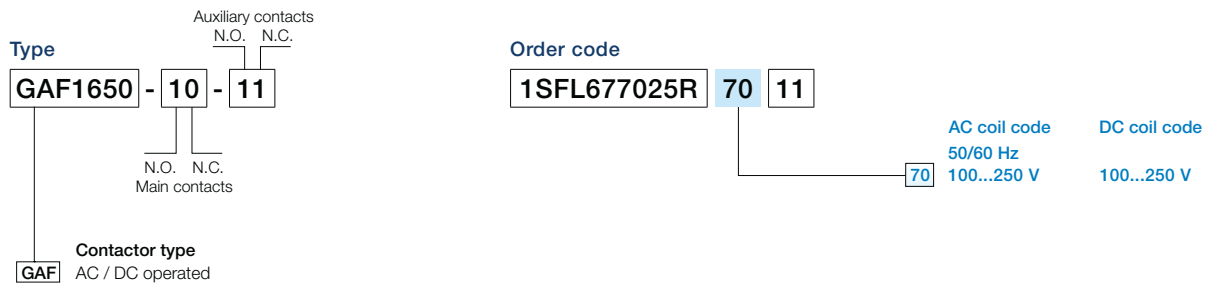

Questionnaire for product specifications: Block contactors

Tel.: e-mail:
Segments:

Tel.: e-mail:
Date:

Application

Type: No of phases:
Utilisation category (AC/DC): % AC4 if any:
Rated operational voltage U_e : V Cos φ :
Frequency: Hz L/R: ms
Nominal current I_n : A
Making current: A Breaking current: A
Duty: continuous temporary intermittent
Load factor (% of ON time): %
Number of cycles per hour: or per year:
Expected durability: operating cycles
Number of main poles N.O.: N.C.:
Other information:

Control circuit

Rated control U_c voltage: V DC AC f: Hz
Minimum / maximum: V to V
Surge suppressor: type:
Interface with PLC: mA V DC
Accessories:
Number of auxiliary contacts: N.O.: N.C.:
Low level contacts: mA V DC AC

Protection

Short circuit protection:
Type: Fuse Circuit breaker Manual motor starter
Max short circuit current: A
Motor protection: Overload relay Manual Motor Starter Electronic overload relay

Installation

Ambient temperature:
Ambient environment:
Humidity: %
Chemical pollution:
Other:
Mounting position, see drawing below (Position 6:
please consult factory):

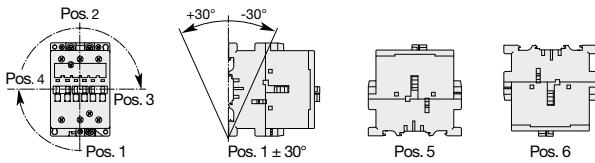

Wiring: Clamping screws or cage connectors
 Cable lugs (ring tongue)
Other: Cross section:
Additional comments:

Logistic and packaging

Quantity by batch:
Delivery order:
Expected quantity: per year
Expected first delivery date: and Qty:
Quantity on first 6 month: on first year:

Approvals and other requirements

Reference standards:
Required approvals:
Customer specifications:
Shock and vibrations:
Specific quality assurance clauses:
Other comments:

Questionnaire for product specifications: Block contactors

Other comments:

.....

.....

.....

.....

.....

.....

.....

.....

.....

User Guide for the questionnaire

This document is used to define the contactor specifications according to the complete information on the application. Do not hesitate to join some complementary documents if necessary (schemes, tables, customer specification...).

Please see below some definitions to help you :

Operating cycle

Includes one making operation and one breaking operation.

Electrical Durability

Number of on-load operating cycles that the contactor is able to carry out. It depends on the utilization category.

Mechanical Durability

Number of no-current operating cycles that the contactor is able to carry out

Load Factor

Ratio of the on-load operating time to the total cycle time x 100 (%).

Intermittent Duty

Duty during which the contactor is successively closed or open for periods which are too short to enable the contactor to achieve thermal balance.

Temporary Duty

Duty in which the main contacts of the contactor remain closed for periods insufficient to allow the equipment to reach stabilized temperature, the unload periods being separated by off-load periods of sufficient duration to restore the ambient temperature

Continuous Duty

Duty in which the main contacts of the contactor remain closed, with a continuous current during enough time to reach thermal stabilization, but no more than eight hours without interruption.

Ambient Temperature

Air temperature close to the contactor.

Mounting Position

Comply with the manufacturer's instructions. Restrictions could be taken into account for certain mounting positions.

A contactor's duty is characterized by the utilization category together with the rated operational voltage and current indicated:

Utilization categories for contactors according to IEC 60947-4-1

Utilization categories for contactor relays according to IEC 60947-5-1

See our catalog p7/8

Making and breaking current

Current at contactor closing or at contactor opening

Time constant L/R (for DC circuit)

Ratio of the inductance to the resistance ($L/R = \text{mH}/\Omega = \text{ms}$)



AS..S, AF..S 3-pole contactors and NS..S, NF..S contactor relays with spring terminals

AS..S 3-pole contactors - with spring terminals

Ordering details	6/4
Technical data	6/10
Electrical durability	6/16
Terminal marking and postioning	6/18
Main dimensions	6/20
Accessories	6/34
Voltage code table	6/41

NS..S contactor relays - with spring terminals

Ordering details	6/22
Technical data	6/26
Terminal marking and postioning	6/30
Main dimensions	6/32
Accessories	6/34
Voltage code table	6/41

AF..S 3-pole contactors - with spring terminals

Overview	6/44
Ordering details	6/46
Technical data	6/52
Electrical durability	6/57
Terminal marking and postioning	6/61
Main dimensions	6/62
Accessories	6/80
Voltage code table	6/88

NF..S contactor relays - with spring terminals

Overview	6/66
Ordering details	6/68
Technical data	6/74
Terminal marking and postioning	6/77
Main dimensions	6/78
Accessories	6/80
Voltage code table	6/88



AS..S 3-pole contactors and NS..S contactor relays with spring terminals

AS..S 3-pole contactors - with spring terminals

AS09..S ... AS16..S	AC operated	6/4
ASL09..S ... ASL16..S	DC operated	6/5
AS09..S ... AS16..S	AC operated - 2-stack	6/6
ASL09..S ... ASL16..S	DC operated - 2-stack	6/7
Main accessories		6/8
Technical data		6/10
Electrical durability		6/16
Terminal marking and postioning		6/18
Main dimensions		6/20

NS..S contactors relays - with spring terminals

NS..S	AC operated	6/22
NSL..S	DC operated	6/23
Main accessories		6/24
Technical data		6/26
Terminal marking and postioning		6/30
Main dimensions		6/32

Accessories

Auxiliary contact blocks - with spring terminals	6/34
Surge suppressors for contactor coils	6/38
Connecting links for starting solution and other accessories	6/40

Voltage code table	6/41
--------------------	------

AS09..S ... AS16..S 3-pole contactors

4 to 7.5 kW

AC operated - with spring terminals



AS09-30-10S



Description

AS09 ... AS16 contactors are mainly used for controlling 3-phase motors and power circuits up to 690 V AC and 220 V DC.

These contactors are of the block type design with:

- spring terminals
- 3 main poles and 1 built-in auxiliary contact
- control circuit: AC operated
- add-on auxiliary contact blocks for front mounting and a comprehensive range of accessories.

Ordering details

IEC Rated operational power 400 V AC-3 kW	Rated operational current $\theta \leq 40^\circ\text{C}$ AC-1 A	UL/CSA 3-phase motor rating 480 V hp	General use rating 600 V AC A	Rated control circuit voltage U_c (1)		Auxiliary contacts fitted		Type	Order code	Weight Pkg (1 pce) kg
				V 50 Hz	V 60 Hz					
4	20	5	12	24	24	1	0	AS09-30-10S-20	1SBL101004R2010	0.220
						0	1	AS09-30-01S-20	1SBL101004R2001	0.220
				230	230	1	0	AS09-30-10S-26	1SBL101004R2610	0.220
						0	1	AS09-30-01S-26	1SBL101004R2601	0.220
5.5	22	7.5	12	24	24	1	0	AS12-30-10S-20	1SBL111004R2010	0.220
						0	1	AS12-30-01S-20	1SBL111004R2001	0.220
				230	230	1	0	AS12-30-10S-26	1SBL111004R2610	0.220
						0	1	AS12-30-01S-26	1SBL111004R2601	0.220
7.5	22	10	15.2	24	24	1	0	AS16-30-10S-20	1SBL121004R2010	0.220
						0	1	AS16-30-01S-20	1SBL121004R2001	0.220
				230	230	1	0	AS16-30-10S-26	1SBL121004R2610	0.220
						0	1	AS16-30-01S-26	1SBL121004R2601	0.220

Note: for multiple packaging, please contact your ABB local sales organization.

(1) Other control voltages see voltage code table.

Main dimensions mm, inches

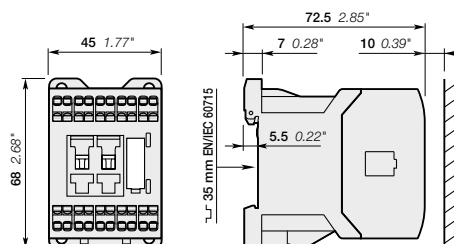

AS09..S, AS12..S, AS16..S

ASL09..S ... ASL16..S 3-pole contactors

4 to 7.5 kW

DC operated - with spring terminals



ASL09-30-10S

Description

ASL09..S ... ASL16..S contactors are mainly used for controlling 3-phase motors and power circuits up to 690 V AC and 220 V DC.

These contactors are of the block type design with:

- spring terminals
- 3 main poles and 1 built-in auxiliary contact
- control circuit: low consumption (3 W at pull-in and holding) DC operated with solid core magnet. Suitable for direct control by PLC outputs (the polarity on the coil terminals A1+ and A2- must be respected)
- add-on auxiliary contact blocks for front mounting and comprehensive range of accessories.

Ordering details

IEC		UL/CSA		Rated control circuit voltage Uc (1)	Auxiliary contacts fitted	Type	Order code	Weight
Rated operational power	current $\theta \leq 40^\circ\text{C}$	3-phase motor rating 480 V	General use rating 600 V AC					
400 V AC-3 kW	AC-1 A	hp	A	V DC				kg
4	20	5	12	24	1 0	ASL09-30-10S-81	1SBL103004R8110	0.280
					0 1	ASL09-30-01S-81	1SBL103004R8101	0.280
5.5	22	7.5	12	24	1 0	ASL12-30-10S-81	1SBL113004R8110	0.280
					0 1	ASL12-30-01S-81	1SBL113004R8101	0.280
7.5	22	10	15.2	24	1 0	ASL16-30-10S-81	1SBL123004R8110	0.280
					0 1	ASL16-30-01S-81	1SBL123004R8101	0.280

Note: for multiple packaging, please contact your ABB local sales organization.

(1) Other control voltages see voltage code table.

Main dimensions mm, inches

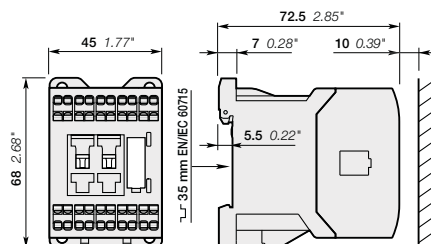

ASL09..S, ASL12..S, ASL16..S

AS09..S ... AS16..S 2-stack 3-pole contactors

4 to 7.5 kW

AC operated - with spring terminals



AS09-30-32S

Description

AS09..S ... AS16..S contactors are mainly used for controlling 3-phase motors and power circuits up to 690 V AC and 220 V DC.

These contactors are of the block type design with:

- spring terminals
- 1st stack with 3 main poles and 1 N.O. built-in auxiliary contact
- 2nd stack with permanently fixed 2 N.O. + 2 N.C. auxiliary contact block
- the auxiliary contact elements are mechanically linked (side-marked symbol) and the N.C. auxiliary contacts are mirror contacts
- control circuit: AC operated
- a comprehensive range of accessories.

Ordering details

IEC Rated operational power 400 V AC-3 kW	UL/CSA 3-phase motor rating 480 V hp	General use rating 600 V AC A	Rated control circuit voltage Uc (1)		Auxiliary contacts fitted		Type	Order code	Weight Pkg (1 pce) kg	
			V 50 Hz	V 60 Hz	I	L				
4	20	5	12	24	24	3	2	AS09-30-32S-20	1SBL101004R2032	0.260
				230	230	3	2	AS09-30-32S-26	1SBL101004R2632	0.260
5.5	22	7.5	12	24	24	3	2	AS12-30-32S-20	1SBL111004R2032	0.260
				230	230	3	2	AS12-30-32S-26	1SBL111004R2632	0.260
7.5	22	10	15.2	24	24	3	2	AS16-30-32S-20	1SBL121004R2032	0.260
				230	230	3	2	AS16-30-32S-26	1SBL121004R2632	0.260

Note: for multiple packaging, please contact your ABB local sales organization.

(1) Other control voltages see voltage code table.

Main dimensions mm, inches

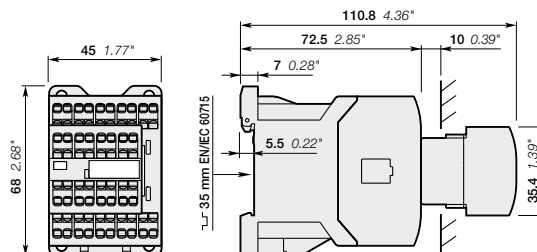

AS09..S, AS12..S, AS16..S

ASL09..S ... ASL16..S 2-stack 3-pole contactors

4 to 7.5 kW

DC operated - with spring terminals



ASL09-30-32S

Description

ASL09..S ... ASL16..S contactors are mainly used for controlling 3-phase motors and power circuits up to 690 V AC and 220 V DC.

These contactors are of the block type design with:

- spring terminals
- 1st stack with 3 main poles and 1 N.O. built-in auxiliary contact
- 2nd stack with permanently fixed 2 N.O. + 2 N.C. auxiliary contact block
- the auxiliary contact elements are mechanically linked (side-marked symbol) and the N.C. auxiliary contacts are mirror contacts
- control circuit: low consumption (3 W at pull-in and holding) DC operated with solid core magnet. Suitable for direct control by PLC outputs (the polarity on the coil terminals A1+ and A2- must be respected)
- a comprehensive range of accessories.

Ordering details

IEC		UL/CSA		Rated control circuit	Auxiliary contacts fitted	Type	Order code	Weight
Rated operational power	operational current $\theta \leq 40^\circ\text{C}$	3-phase motor rating	General use rating	voltage U_c (1)				Pkg (1 pce)
400 V AC-3	AC-1	480 V	600 V AC	V DC				kg
4 kW	20 A	5 hp	12 A	24	3 2	ASL09-30-32S-81	1SBL103004R8132	0.320
5.5 kW	22 A	7.5 hp	12 A	24	3 2	ASL12-30-32S-81	1SBL113004R8132	0.320
7.5 kW	22 A	10 hp	15.2 A	24	3 2	ASL16-30-32S-81	1SBL123004R8132	0.320

Note: for multiple packaging, please contact your ABB local sales organization.

(1) Other control voltages see voltage code table.

Main dimensions mm, inches

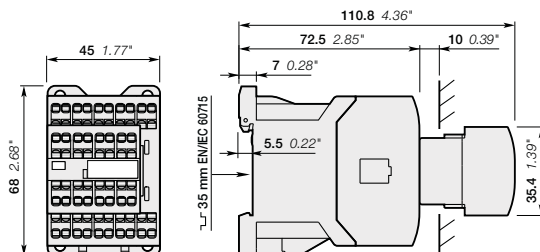

ASL09..S, ASL12..S, ASL16..S

AS09..S ... AS16..S and ASL09..S ... ASL16..S 3-pole contactors - with spring terminals Main accessories

Contactor and main accessories (other accessories available)

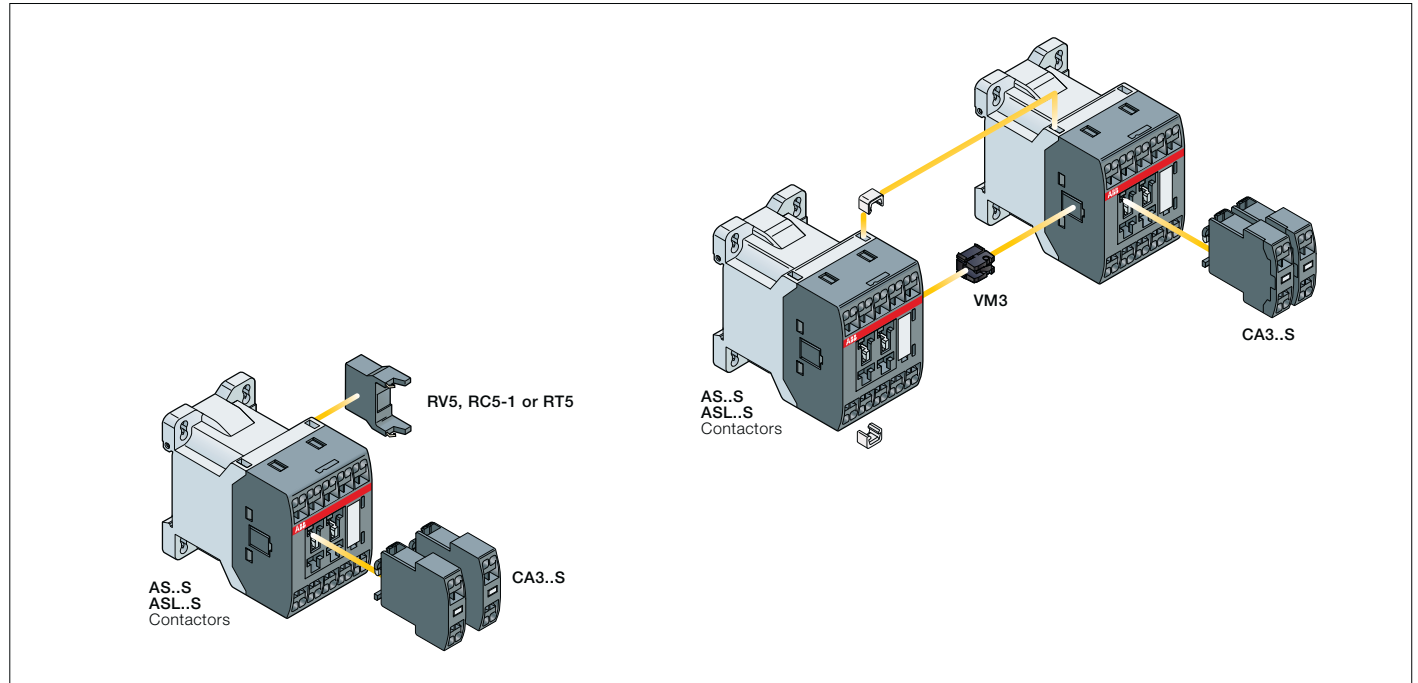

6

Main accessory fitting details

Contactor types	Main poles	Built-in auxiliary contacts	Front-mounted accessories		Side-mounted accessories	
			Auxiliary contact blocks	Mechanical interlock unit (between 2 contactors)	Surge suppressors	
			1-pole CA3..S	VM3		
AS09..S ... AS16..S	3 0	1 0	2 max.	+ 1	+ RV5	or RC5-1
AS09..S ... AS16..S	3 0	0 1		1	+ RV5	or RC5-1
AS09..S ... AS16..S	3 0	3 2	–	+ 1	+ RV5	or RT5
ASL09..S ... ASL16..S	3 0	1 0	2 max.			
ASL09..S ... ASL16..S	3 0	0 1		1	+ RV5	or RT5
ASL09..S ... ASL16..S	3 0	3 2	–			

AS09..S ... AS16..S and ASL09..S ... ASL16..S 3-pole contactors - with spring terminals

Main accessories



CA3-10S

1SBC101003FF0014

Front-mounted instantaneous auxiliary contact blocks

For contactors	Auxiliary contacts	Type	Order code	Pkg qty	Weight (1 pce)
					kg
AS09..S ... AS16..S	1 0	CA3-10S	1SBN011019T1010	10	0.011
ASL09..S ... ASL16..S	0 1	CA3-01S	1SBN011019T1001	10	0.011



VM3

1SBC101006FF0014

Mechanical interlock unit

For contactors	Type	Order code	Pkg qty	Weight (1 pce)
AS09..S ... AS16..S, ASL09..S ... ASL16..S	VM3	1SBN031005T1000	10	0.002



RV5

1SBC574001FG001

Surge suppressors

For contactors	Rated control circuit voltage - U _c			Type	Order code	Pkg qty	Weight (1 pce)
	V	AC	DC				
AS09..S ... AS16..S, ASL09..S ... ASL16..S	24...50	●	●	RV5/50	1SBN050010R1000	2	0.015
	50...133	●	●	RV5/133	1SBN050010R1001	2	0.015
	110...250	●	●	RV5/250	1SBN050010R1002	2	0.015
	250...440	●	●	RV5/440	1SBN050010R1003	2	0.015
AS09..S ... AS16..S	24...50	●	-	RC5-1/50	1SBN050100R1000	2	0.012
	50...133	●	-	RC5-1/133	1SBN050100R1001	2	0.012
	110...250	●	-	RC5-1/250	1SBN050100R1002	2	0.012
	250...440	●	-	RC5-1/440	1SBN050100R1003	2	0.012
ASL09..S ... ASL16..S	12...32	-	●	RT5/32	1SBN050020R1000	2	0.015
	25...65	-	●	RT5/65	1SBN050020R1001	2	0.015
	50...90	-	●	RT5/90	1SBN050020R1002	2	0.015
	77...150	-	●	RT5/150	1SBN050020R1003	2	0.015
	150...264	-	●	RT5/264	1SBN050020R1004	2	0.015



BEA16-3U

1SBC101384FF0010

Connecting links with manual motor starters

For contactors	Manual motor starter	Type	Order code	Pkg qty	Weight (1 pce)
AS09..S ... AS16..S ASL09..S ... ASL16..S	MS116-0.16 ... MS116-16 MS132-0.16 ... MS132-16	BEA16-3U	1SBN081020R1000	1	0.045

AS09..S ... AS16..S and ASL09..S ... ASL16..S 3-pole contactors - with spring terminals

Technical data

Main pole - Utilization characteristics according to IEC

Contactor types	AC operated	AS09..S	AS12..S	AS16..S
	DC operated	ASL09..S	ASL12..S	ASL16..S
Standards		IEC 60947-1 / 60947-4-1 and EN 60947-1 / 60947-4-1		
Rated operational voltage U_e max.		690 V		
Rated frequency (without derating)		50 / 60 Hz		
Conventional free-air thermal current I_{th}				
acc. to IEC 60947-4-1, open contactors, $\theta \leq 40$ °C		20 A	22 A	22 A
With conductor cross-sectional area		2.5 mm ²	2.5 mm ²	2.5 mm ²
AC-1 Utilization category				
For air temperature close to contactor				
I_e / Rated operational current AC-1	$\theta \leq 40$ °C	20 A	22 A	22 A
U _e max. \leq 690 V, 50/60 Hz	$\theta \leq 60$ °C	15 A	17 A	17 A
	$\theta \leq 70$ °C	12 A	14 A	14 A
With conductor cross-sectional area		2.5 mm ²		
AC-3 Utilization category				
For air temperature close to contactor $\theta \leq 60$ °C				
I_e / Max. rated operational current AC-3 (1)				
	220-230-240 V	9 A	12 A	15.7 A
	400 V	9 A	12 A	15.5 A
	415 V	9 A	12 A	15.5 A
	440 V	8 A	11 A	13.6 A
	500 V	8 A	11 A	12.5 A
	690 V	5 A	7 A	9 A
Rated operational power AC-3 (1)				
	220-230-240 V	2.2 kW	3 kW	4 kW
	400 V	4 kW	5.5 kW	7.5 kW
	415 V	4 kW	5.5 kW	7.5 kW
	440 V	4 kW	5.5 kW	7.5 kW
	500 V	4 kW	5.5 kW	7.5 kW
	690 V	4 kW	5.5 kW	7.5 kW
Rated making capacity AC-3		10 x I _e AC-3 acc. to IEC 60947-4-1		
Rated breaking capacity AC-3		8 x I _e AC-3 acc. to IEC 60947-4-1		
AC-8a Utilization category				
(without thermal overload relay - U _e 400 V 50/60 Hz - $\theta \leq 40$ °C)				
I_e / Rated operational current AC-8a		12 A	16 A	22 A
Rated operational power AC-8a		5.5 kW	7.5 kW	11 kW
Short-circuit protection device for contactors				
without thermal overload relay - Motor protection excluded (2)				
U _e \leq 500 V AC - gG type fuse		25 A		
Rated short-time withstand current I_{cw}				
at 40 °C ambient temperature,	1 s	230 A	250 A	250 A
in free air from a cold state	10 s	100 A	124 A	124 A
	30 s	65 A	75 A	75 A
	1 min	50 A	55 A	55 A
	15 min	20 A	22 A	22 A
Maximum breaking capacity				
cos ϕ = 0.45	at 440 V	155 A		
	at 690 V	90 A		
Power dissipation per pole				
	I _e / AC-1	0.9 W	1.1 W	1.1 W
	I _e / AC-3	0.18 W	0.33 W	0.55 W
Max. electrical switching frequency				
	AC-1	600 cycles/h		
	AC-3	1200 cycles/h		
	AC-4	300 cycles/h		

(1) For the corresponding kW/A or hp/A values of 1500 r.p.m, 50 Hz or 1800 r.p.m, 60 Hz, 3-phase motors, see "Motor rated operational powers and currents".

(2) For the protection of motor starters against short circuits, see "Coordination with short-circuit protection devices".



3-phase motors



1500 r.p.m. 50 Hz
1800 r.p.m. 60 Hz
3-phase motors

AS09..S ... AS16..S and ASL09..S ... ASL16..S 3-pole contactors - with spring terminals

Technical data

Main pole - Utilization characteristics according to UL / NEMA / CSA

Contactor types	AC operated	AS09..S	AS12..S	AS16..S
	DC operated	ASL09..S	ASL12..S	ASL16..S
Standards	UL 508, CSA C22.2 N°14			
Max. operational voltage	690 V			
NEMA size	00		00	
NEMA continuous amp rating	Thermal current	9 A		
NEMA maximum horse power ratings 1-phase, 60 Hz	115 V AC	1/3 hp	1/3 hp	1/3 hp
	230 V AC	1 hp	1 hp	1 hp
NEMA maximum horse power ratings 3-phase, 60 Hz	200 V AC	1-1/2 hp	1-1/2 hp	1-1/2 hp
	230 V AC	1-1/2 hp	1-1/2 hp	1-1/2 hp
	460 V AC	2 hp	2 hp	2 hp
	575 V AC	2 hp	2 hp	2 hp
UL / CSA General use rating	600 V AC	12 A	12 A	15.2 A
	With conductor cross-sectional area	AWG 14	AWG 14	AWG 12
UL / CSA maximum 1-phase motor rating	Full load current	120 V AC	7.2 A	9.8 A
		240 V AC	8 A	10 A
	Horse power rating	120 V AC	1/3 hp	1/2 hp
		240 V AC	1 hp	1-1/2 hp
UL / CSA maximum 3-phase motor rating	Full load current (1)	200-208 V AC	7.8 A	7.8 A
		220-240 V AC	6.8 A	9.6 A
		440-480 V AC	7.6 A	11 A
		550-600 V AC	9 A	11 A
	Horse power rating (1)	200-208 V AC	2 hp	2 hp
		220-240 V AC	2 hp	3 hp
		440-480 V AC	5 hp	7-1/2 hp
		550-600 V AC	7-1/2 hp	10 hp
Short-circuit protection device for contactors without thermal overload relay - Motor protection excluded	Fuse rating	40 A	50 A	60 A
	Fuse type, 600 V	J		
	Max. electrical switching frequency	For general use	600 cycles/h	
For motor use		1200 cycles/h		

(1) For the corresponding kW/A or hp/A values of 1500 r.p.m, 50 Hz or 1800 r.p.m, 60 Hz, 3-phase motors, see "Motor rated operational powers and currents".

General technical data

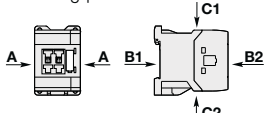
Contactor types	AC operated	AS09..S	AS12..S	AS16..S
	DC operated	ASL09..S	ASL12..S	ASL16..S
Rated insulation voltage Ui	acc. to IEC 60947-4-1	690 V		
	acc. to UL / CSA	600 V		
Rated impulse withstand voltage Uimp.	6 kV			
Ambient air temperature close to contactor	Operation	-40...+70 °C		
	Storage	-60...+80 °C		
Climatic withstand	Category B according to IEC 60947-1 Annex Q			
Maximum operating altitude (without derating)	3000 m			
Mechanical durability	Number of operating cycles	10 millions operating cycles		
	Max. switching frequency	3600 cycles/h		
Shock withstand acc. to IEC 60068-2-27 and EN 60068-2-27	1/2 sinusoidal shock for 11 ms: no change in contact position, closed or open position			
	Shock direction	AS contactors - AC operated		ASL contactors - DC operated
Mounting position 1 	A	20 g		20 g closed position / 10 g open position
	B1	10 g closed position / 5 g open position		15 g closed position / 5 g open position
	B2	15 g		10 g
	C1	20 g closed position / 9 g open position		15 g closed position / 8 g open position
	C2	20 g closed position / 14 g open position		14 g closed position / 8 g open position
	Vibration withstand acc. to IEC 60068-2-6	5...300 Hz / 3 g closed position / 2 g open position		

AS09..S ... AS16..S and ASL09..S ... ASL16..S 3-pole contactors - with spring terminals

Technical data

Magnet system characteristics for AS09..S ... AS16..S contactors

Contactor types	AC operated	AS09..S	AS12..S	AS16..S
Coil operating limits	AC supply	0.85...1.1 x U _c (at $\theta \leq 60$ °C); U _c (at $\theta \leq 70$ °C)		
acc. to IEC 60947-4-1				
AC control voltage	Rated control circuit voltage U _c	at 50 Hz	24...415 V	
		at 60 Hz	24...415 V	
Coil consumption	Average pull-in value	50 Hz	33 VA	
		60 Hz	33 VA	
		50/60 Hz	33 VA	
	Average holding value	50 Hz	6.5 VA / 1.5 W	
		60 Hz	5 VA / 1.2 W	
		50/60 Hz	6.5 VA / 1.5 W	
Drop-out voltage		Approx. 30...50 % of U _c		
Operating time				
Between coil energization and:	N.O. contact closing	9...24 ms		
	N.C. contact opening	6...18 ms		
Between coil de-energization and:	N.O. contact opening (1)	5...19 ms		
	N.C. contact closing (1)	7...22 ms		
(1) The use of RC5-1 surge suppressor increases opening time by a factor of 2 to 3.				

6

Magnet system characteristics for ASL09..S ... ASL16..S contactors

Contactor types	DC operated	ASL09..S	ASL12..S	ASL16..S
Coil operating limits	DC supply	0.85...1.1 x U _c (at $\theta \leq 60$ °C); U _c (at $\theta \leq 70$ °C)		
acc. to IEC 60947-4-1				
DC control voltage	Rated control circuit voltage U _c	12...240 V DC		
	Coil consumption	Average pull-in value	3 W	
		Average holding value	3 W	
Drop-out voltage		Approx. 10...40 % of U _c		
Coil time constant	Open	L/R	12 ms	
	Closed	L/R	40 ms	
Operating time				
Between coil energization and:	N.O. contact closing	36...59 ms		
	N.C. contact opening	31...53 ms		
Between coil de-energization and:	N.O. contact opening (1)	13...17 ms		
	N.C. contact closing (1)	15...20 ms		
(1) The use of RT5 surge suppressor increases opening time by a factor of 1.1 to 1.2				







Mounting characteristics and conditions for use

Contactor types	AC operated	AS09..S	AS12..S	AS16..S
	DC operated	ASL09..S	ASL12..S	ASL16..S
Mounting positions				
Mounting distances	The contactors can be assembled side by side.			
Fixing	On rail according to IEC 60715, EN 60715	35 x 7.5 mm or 35 x 15 mm		
	By screws (not supplied)	2 x M4 screws placed diagonally		

AS09..S ... AS16..S and ASL09..S ... ASL16..S 3-pole contactors - with spring terminals

Technical data

Connecting characteristics

Contactor types	AC operated	AS09..S	AS12..S	AS16..S
	DC operated	ASL09..S	ASL12..S	ASL16..S
Main terminals	 Spring terminals			
Connection capacity (min. ... max.)				
Main conductors (poles)				
 Rigid	1 x	0.75...2.5 mm ²		
	2 x	0.75...2.5 mm ²		
 Flexible with non insulated ferrule	1 x	0.75...2.5 mm ²		
	2 x	0.75...2.5 mm ²		
 Flexible with insulated ferrule	1 x	0.75...1.5 mm ²		
	2 x	0.75...1.5 mm ²		
Connection capacity acc. to UL / CSA	1 or 2 x	AWG 18...12		
Stripping length	10 mm			
Auxiliary conductors (built-in auxiliary terminals + coil terminals)				
 Rigid solid	1 x	0.75...2.5 mm ²		
	2 x	0.75...2.5 mm ²		
 Flexible with non insulated ferrule	1 x	0.75...2.5 mm ²		
	2 x	0.75...2.5 mm ²		
 Flexible with insulated ferrule	1 x	0.75...1.5 mm ²		
	2 x	0.75...1.5 mm ²		
Connection capacity acc. to UL / CSA	1 or 2 x	AWG 18...14		
Stripping length	10 mm			
Degree of protection				
acc. to IEC 60947-1 / EN 60947-1 and IEC 60529 / EN 60529				
All terminals	IP20			
Screwdriver type	Flat Ø 3.5			

AS09..S ... AS16..S and ASL09..S ... ASL16..S 3-pole contactors - with spring terminals

Technical data

Built-in auxiliary contacts according to IEC

Contactor types	AC operated	AS09..S	AS12..S	AS16..S
	DC operated	ASL09..S	ASL12..S	ASL16..S
Rated operational voltage U _e max.	690 V			
Rated frequency (without derating)	50 / 60 Hz			
Conventional free air thermal current I _{th} - 0 ≤ 40 °C	10 A			
I _e / Rated operational current AC-15 acc. to IEC 60947-5-1	24-127 V 50/60 Hz	6 A		
	220-240 V 50/60 Hz	4 A		
	400-440 V 50/60 Hz	3 A		
	500 V 50/60 Hz	2 A		
	690 V 50/60 Hz	2 A		
Making capacity AC-15	10 x I _e AC-15 acc. to IEC 60947-5-1			
Breaking capacity AC-15	10 x I _e AC-15 acc. to IEC 60947-5-1			
I _e / Rated operational current DC-13 acc. to IEC 60947-5-1	24 V DC	6 A / 144 W		
	48 V DC	2.8 A / 134 W		
	72 V DC	1 A / 72 W		
	110 V DC	0.55 A / 60 W		
	125 V DC	0.55 A / 69 W		
	220 V DC	0.27 A / 60 W		
	250 V DC	0.27 A / 68 W		
Short-circuit protection device gG type fuse	10 A			
Rated short-time withstand current I _{cw}	for 1.0 s	100 A		
	for 0.1 s	140 A		
Minimum switching capacity with failure rate acc. to IEC 60947-5-4	12 V / 3 m			
	10 ⁻⁷			
Non-overlapping time between N.O. and N.C. contacts	1.5 ms			
Power dissipation per pole at 6 A	0.1 W			
Max. electrical switching frequency	AC-15	1200 cycles/h		
	DC-13	900 cycles/h		
Mechanically linked contacts acc. to annex L of IEC 60947-5-1	Built-in N.O. or N.C. auxiliary contacts and additional N.O. or N.C. auxiliary contacts (CA3 aux. contact blocks) are mechanically linked contacts.			
Mirror contacts acc. to annex F of IEC 60947-4-1	Built-in N.C. auxiliary contacts or additional N.C. auxiliary contacts (CA3 aux. contact blocks) are mirror contacts.			

Built-in auxiliary contacts according to UL / CSA

Contactor types	AC operated	AS09..S	AS12..S	AS16..S
	DC operated	ASL09..S	ASL12..S	ASL16..S
Max. operational voltage	600 V AC, 250 V DC			
Pilot duty	A600, Q300			
AC thermal rated current	10 A			
AC maximum volt-ampere making	7200 VA			
AC maximum volt-ampere breaking	720 VA			
DC thermal rated current	2.5 A			
DC maximum volt-ampere making-breaking	69 VA			

Notes

A series of horizontal dotted lines for taking notes, spanning the width of the page.

AS09..S ... AS16..S and ASL09..S ... ASL16..S 3-pole contactors - with spring terminals

Electrical durability

Electrical durability for AC-1 utilization category - $U_e \leq 690 \text{ V}$

Note: AC-1 maximum current is selected according to ambient temperature. Please see technical data.

Switching non-inductive or slightly inductive loads. The breaking current I_c for AC-1 is equal to the rated operational current of the load. Maximum electrical switching frequency: 600 cycles / hour.

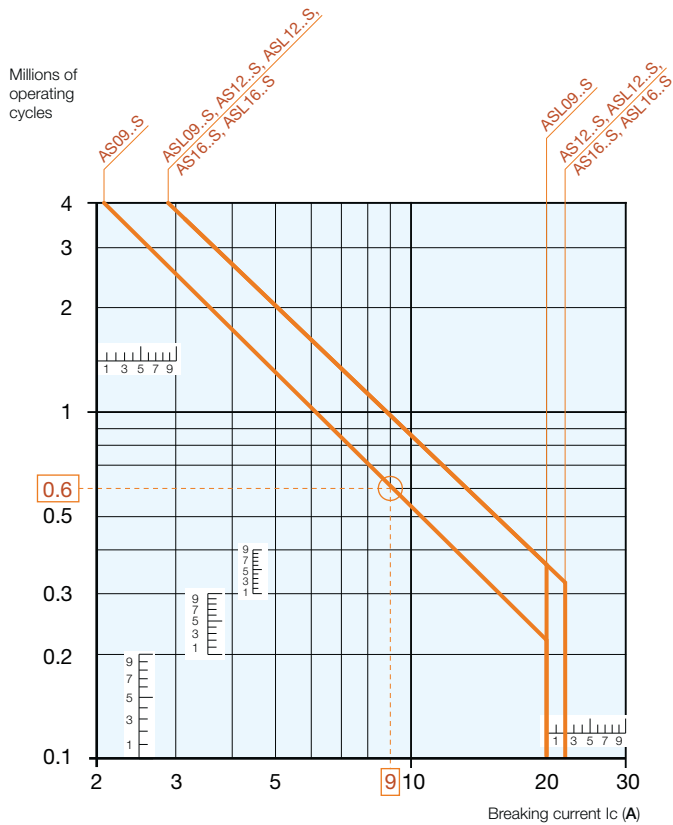

Example:

Breaking current = 9 A.

On the opposite curve at intersection "○" 9 A the corresponding value for the electrical durability is approximately 0.6 millions operating cycles.

AS09..S ... AS16..S and ASL09..S ... ASL16..S 3-pole contactors - with spring terminals

Electrical durability

Electrical durability for AC-3 utilization category - $U_e \leq 440 \text{ V}$ - Ambient temperature $\leq 60 \text{ }^\circ\text{C}$

Switching cage motors: starting and switching off running motors. The breaking current I_c for AC-3 is equal to the rated operational current I_e (I_e = motor full load current). Maximum electrical switching frequency: 1200 cycles / hour.

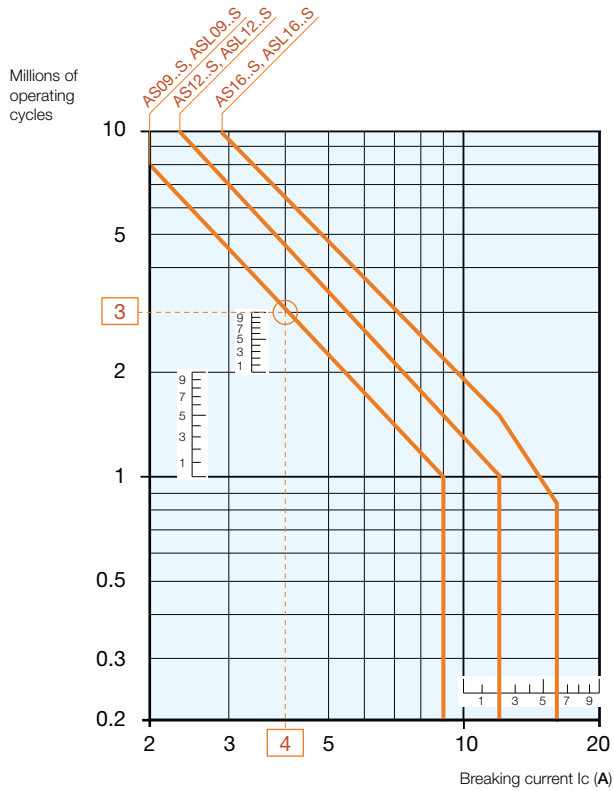

Example:

Breaking current = 4 A.

On the opposite curve at intersection "○" 4 A the corresponding value for the electrical durability is approximately 3 millions operating cycles.

ASL09..S ... ASL16..S 3-pole contactors - with spring terminals

Terminal marking and positioning

ASL..S contactors - DC operated (the polarity A1+, A2- must be respected)

Standard devices without addition of auxiliary contacts

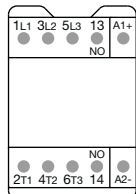

ASL09 ... ASL16-30-10S

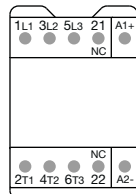

ASL09 ... ASL16-30-01S

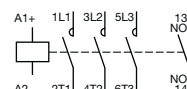

ASL09 ... ASL16-30-10S

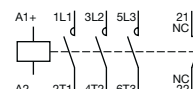

ASL09 ... ASL16-30-01S

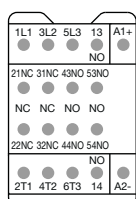

ASL09 ... ASL16-30-32

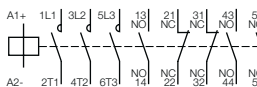

ASL09 ... ASL16-30-32S

Other possible contact combinations with auxiliary contact blocks added by the user

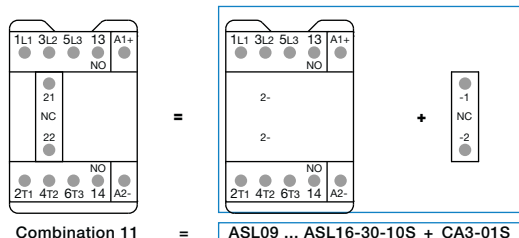

Combination 11

ASL09 ... ASL16-30-10S + CA3-01S

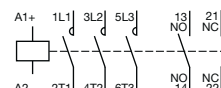

Combination 11

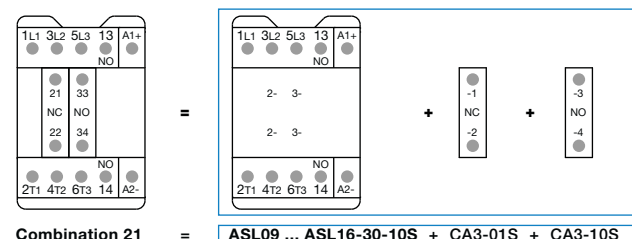

Combination 21

ASL09 ... ASL16-30-10S + CA3-01S + CA3-10S

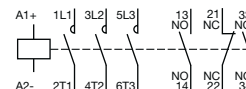

Combination 21

CA3..S 1-pole auxiliary contact blocks

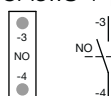

CA3-10S

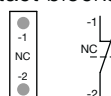

CA3-01S

AS09..S ... AS16..S 3-pole contactors - with spring terminals

Main dimensions mm, inches

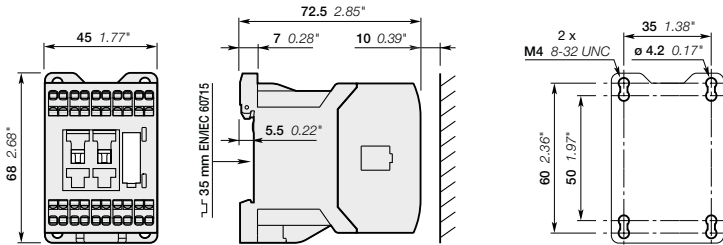

AS09..S, AS12..S, AS16..S

6

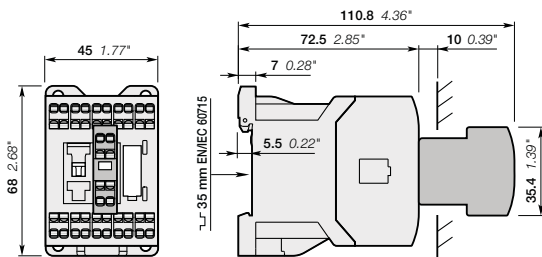

AS09..S, AS12..S, AS16..S
+ CA3..S front-mounted 1-pole auxiliary contact block

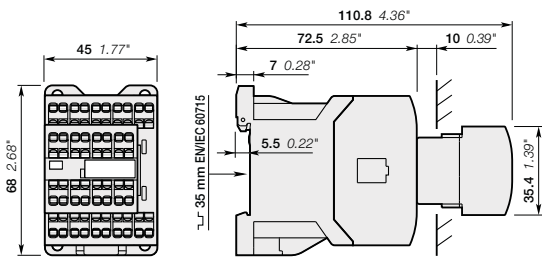

AS09...16-30-32S

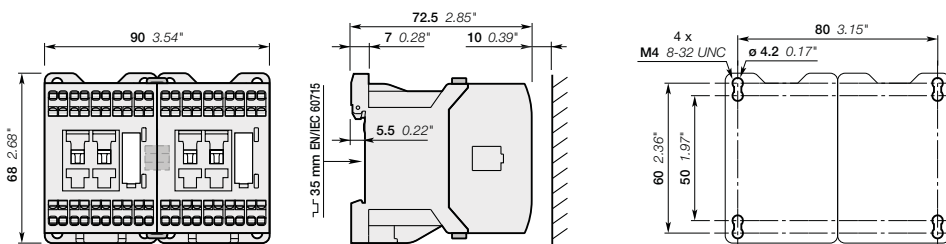

AS09..S, AS12..S, AS16..S
+ VM3 mechanical interlock unit including two BB3 fixing clips

ASL09..S ... ASL16..S 3-pole contactors - with spring terminals

Main dimensions mm, inches

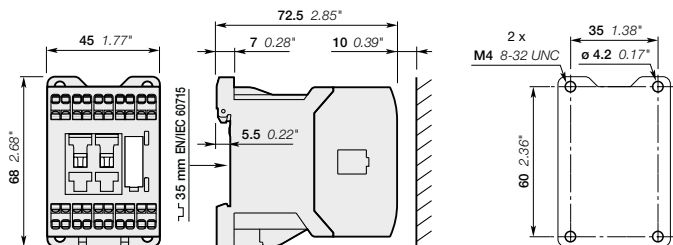

ASL09..S, ASL12..S, ASL16..S

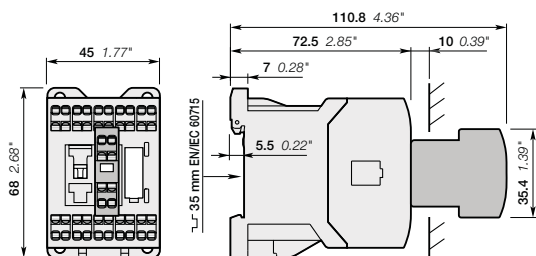

ASL09..S, ASL12..S, ASL16..S
+ CA3..S front-mounted 1-pole auxiliary contact block

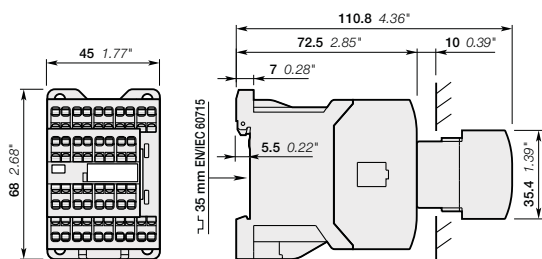

ASL09...16-30-32S

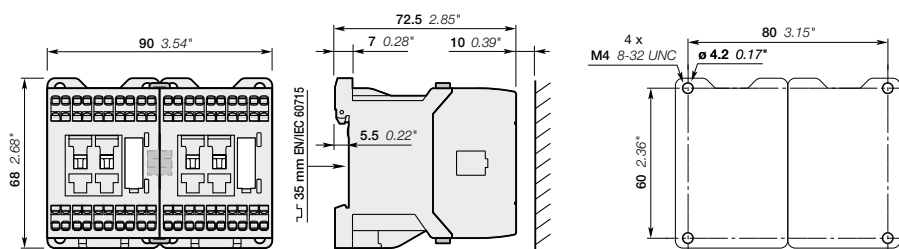

ASL09..S, ASL12..S, ASL16..S
+ VM3 mechanical interlock unit including two BB3 fixing clips

NS..S contactor relays - with spring terminals AC operated



NS22ES

1SBCT101015FC014

Description

NS..S contactor relays are used for switching auxiliary and control circuits.

These contactor relays are designed with:

- spring terminals
- 4 poles or 8 poles. Contactor relays have mechanically linked auxiliary contact elements (side-marked symbol)
- control circuit: AC operated
- add-on auxiliary contact blocks for front mounting and a comprehensive range of accessories.

Ordering details

Number of contacts 1st stack	2nd stack	Rated control circuit voltage Uc (1)		Type	Order code	Weight Pkg (1 pce) kg
		V 50 Hz	V 60 Hz			
		24	24	NS22ES-20	1SBH101004R2022	0.220
		230	230	NS22ES-26	1SBH101004R2622	0.220
		24	24	NS31ES-20	1SBH101004R2031	0.220
		230	230	NS31ES-26	1SBH101004R2631	0.220
		24	24	NS40ES-20	1SBH101004R2040	0.220
		230	230	NS40ES-26	1SBH101004R2640	0.220
		24	24	NS44ES-20	1SBH101004R2044	0.260
		230	230	NS44ES-26	1SBH101004R2644	0.260
		24	24	NS53ES-20	1SBH101004R2053	0.260
		230	230	NS53ES-26	1SBH101004R2653	0.260
		24	24	NS62ES-20	1SBH101004R2062	0.260
		230	230	NS62ES-26	1SBH101004R2662	0.260
		24	24	NS71ES-20	1SBH101004R2071	0.260
		230	230	NS71ES-26	1SBH101004R2671	0.260
		24	24	NS80ES-20	1SBH101004R2080	0.260
		230	230	NS80ES-26	1SBH101004R2680	0.260

Note: for multiple packaging, please contact your ABB local sales organization.

(1) Other control voltages see voltage code table.

Main dimensions mm, inches

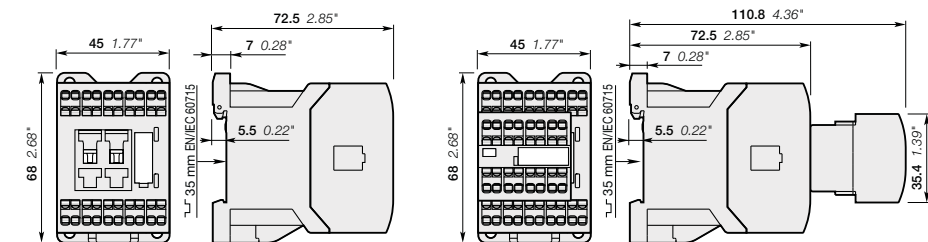

NS22ES, NS31ES, NS40ES

NS44ES, NS53ES, NS62ES, NS71ES, NS80ES

NSL..S contactor relays - with spring terminals

DC operated



NSL22ES

Description

NSL..S contactor relays are used for switching auxiliary and control circuits.

These contactor relays are designed with:

- spring terminals
- 4 poles or 8 poles. Contactor relays have mechanically linked auxiliary contact elements (side-marked symbol)
- control circuit: low coil consumption (3 W at pull-in and holding) DC operated with solid core magnet. Suitable for direct control by PLC outputs (the polarity on the coil terminals A1+ and A2- must be respected)
- add-on auxiliary contact blocks for front mounting and a comprehensive range of accessories.

Ordering details

Number of contacts 1st stack	2nd stack	Rated control circuit voltage	Type	Order code	Weight
		U _c (1) V DC			
		24	NSL22ES-81	1SBH103004R8122	0.280
		24	NSL31ES-81	1SBH103004R8131	0.280
		24	NSL40ES-81	1SBH103004R8140	0.280
		24	NSL44ES-81	1SBH103004R8144	0.320
		24	NSL53ES-81	1SBH103004R8153	0.320
		24	NSL62ES-81	1SBH103004R8162	0.320
		24	NSL71ES-81	1SBH103004R8171	0.320
		24	NSL80ES-81	1SBH103004R8180	0.320

Note: for multiple packaging, please contact your ABB local sales organization.

(1) Other control voltages see voltage code table.

Main dimensions mm, inches

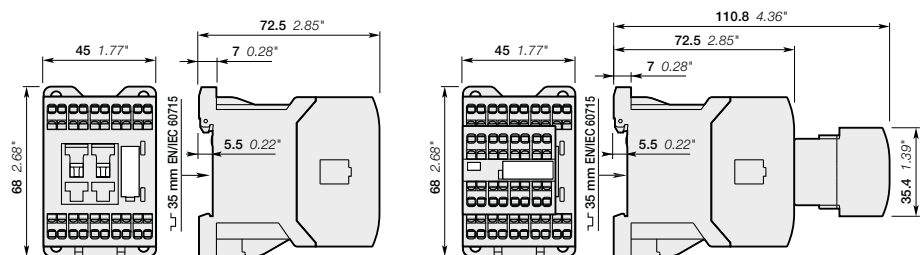

NSL22ES, NSL31ES, NSL40ES

NSL44ES, NSL53ES, NSL62ES, NSL71ES, NSL80ES

NS..S and NSL..S contactor relays - with spring terminals

Main accessories

Contactor relays and main accessories

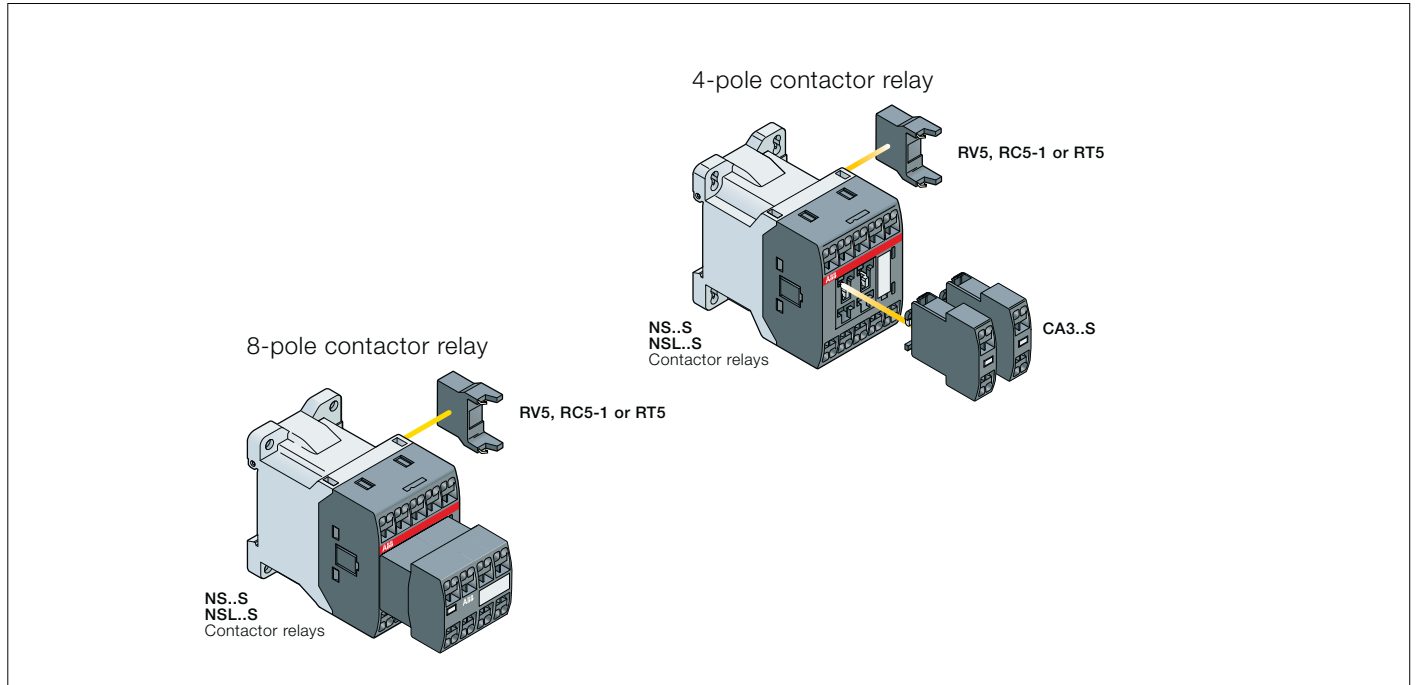

6

Main accessory fitting details

Contactor types	Main poles	Front-mounted accessories		Side-mounted accessories	
		Auxiliary contact blocks		Surge suppressors	
		1-pole CA3..S		Surge suppressors	
NS..S	2 2 E	2 max.		+	RV5 or RC5-1
NS..S	3 1 E				
NS..S	4 0 E				
NS..S	4 4 E	-			RV5 or RC5-1
NS..S	5 3 E				
NS..S	6 2 E				
NS..S	7 1 E				
NS..S	8 0 E				
NSL..S	2 2 E	2 max.		+	RV5 or RT5
NSL..S	3 1 E				
NSL..S	4 0 E				
NSL..S	4 4 E	-			RV5 or RT5
NSL..S	5 3 E				
NSL..S	6 2 E				
NSL..S	7 1 E				
NSL..S	8 0 E				

NS..S and NSL..S contactor relays - with spring terminals

Main accessories



CA3-10S

Front mounted instantaneous auxiliary contact blocks

For contactor relays	Auxiliary contacts		Type	Order code	Pkg qty	Weight (1 pce) kg
	1	0				
NS..S, NSL..S	1	0	CA3-10S	1SBN011019T1010	10	0.011
	0	1	CA3-01S	1SBN011019T1001	10	0.011



RV5

Surge suppressors

For contactor relays	Rated control circuit voltage - Uc			Type	Order code	Pkg qty	Weight (1 pce) kg
	V	AC	DC				
NS..S, NSL..S	24...50	●	●	RV5/50	1SBN050010R1000	2	0.015
	50...133	●	●	RV5/133	1SBN050010R1001	2	0.015
	110...250	●	●	RV5/250	1SBN050010R1002	2	0.015
	250...440	●	●	RV5/440	1SBN050010R1003	2	0.015
NS..S	24...50	●	-	RC5-1/50	1SBN050100R1000	2	0.012
	50...133	●	-	RC5-1/133	1SBN050100R1001	2	0.012
	110...250	●	-	RC5-1/250	1SBN050100R1002	2	0.012
	250...440	●	-	RC5-1/440	1SBN050100R1003	2	0.012
NSL..S	12...32	-	●	RT5/32	1SBN050020R1000	2	0.015
	25...65	-	●	RT5/65	1SBN050020R1001	2	0.015
	50...90	-	●	RT5/90	1SBN050020R1002	2	0.015
	77...150	-	●	RT5/150	1SBN050020R1003	2	0.015
	150...264	-	●	RT5/264	1SBN050020R1004	2	0.015

NS..S and NSL..S contactor relays - with spring terminals

Technical data

Contact utilization characteristics according to IEC

Contactor relay types	AC operated	NS..S
	DC operated	NSL..S
Standards	IEC 60947-5-1 and EN 60947-5-1	
Rated operational voltage U _e max.	690 V	
Rated frequency (without derating)	50 / 60 Hz	
Conventional free-air thermal current I _{th} θ ≤ 40 °C	10 A	
I _e / Rated operational current AC-15		
acc. to IEC 60947-5-1	24-127 V 50/60 Hz	6 A
	220-240 V 50/60 Hz	4 A
	400-440 V 50/60 Hz	3 A
	500 V 50/60 Hz	2 A
	690 V 50/60 Hz	2 A
Making capacity AC-15	10 x I _e AC-15 acc. to IEC 60947-5-1	
Breaking capacity AC-15	10 x I _e AC-15 acc. to IEC 60947-5-1	
I _e / Rated operational current DC-13		
acc. to IEC 60947-5-1	24 V DC	6 A / 144 W
	48 V DC	2.8 A / 134 W
	72 V DC	1 A / 72 W
	110 V DC	0.55 A / 60 W
	125 V DC	0.55 A / 69 W
	220 V DC	0.27 A / 60 W
	250 V DC	0.27 A / 68 W
Short-circuit protection device for contactors		
U _e ≤ 500 V AC - gG type fuse	10 A	
Rated short-time withstand current I _{cw}	for 1.0 s	100 A
at 40 °C ambient temperature, in free air from a cold state	for 0.1 s	140 A
Minimum switching capacity	12 V / 3 mA	
with failure rate acc. to IEC 60947-5-4	10 ⁻⁷	
Non-overlapping time between N.O. and N.C. contacts	1.5 ms	
Power dissipation per pole at 6 A	0.1 W	
Max. electrical switching frequency	AC-15	1200 cycles/h
	DC-13	900 cycles/h
Mechanically linked contacts	Built-in N.O. or N.C. auxiliary contacts and additional N.O. or N.C. auxiliary contacts (CA3..S aux. contact blocks) are mechanically linked contacts.	
acc. to annex L of IEC 60947-5-1		

Contact utilization characteristics according to UL / CSA

Contactor relay types	AC operated	NS..S
	DC operated	NSL..S
Standards	UL 508, CSA C22.2 N°14	
Max. operational voltage	600 V AC, 250 V DC	
Pilot duty	A600, Q300	
AC thermal rated current	10 A	
AC maximum volt-ampere making	7200 VA	
AC maximum volt-ampere breaking	720 VA	
DC thermal rated current	2.5 A	
DC maximum volt-ampere making-breaking	69 VA	

NS..S and NSL..S contactor relays - with spring terminals

Technical data

Magnet system characteristics for NS..S contactor relays

Contactor relay types	AC operated	NS..S	
Coil operating limits	AC supply		
acc. to IEC 60947-5-1		0.85...1.1 x U _c (at $\theta \leq 60\text{ °C}$); U _c (at $\theta \leq 70\text{ °C}$)	
AC control voltage	Rated control circuit voltage U _c	at 50 Hz	24...415 V
		at 60 Hz	24...415 V
Coil consumption	Average pull-in value	50 Hz	33 VA
		60 Hz	33 VA
		50/60 Hz	33 VA
	Average holding value	50 Hz	6.5 VA / 1.5 W
		60 Hz	5 VA / 1.2 W
		50/60 Hz	6.5 VA / 1.5 W
Drop-out voltage		Approx. 30...50 % of U _c	
Operating time			
Between coil energization and:	N.O. contact closing	9...24 ms	
	N.C. contact opening	6...18 ms	
Between coil de-energization and:	N.O. contact opening (1)	5...19 ms	
	N.C. contact closing (1)	7...22 ms	
(1) The use of RC5-1 surge suppressor increases opening time by a factor of 2 to 3.			

Magnet system characteristics for NSL..S contactor relays

Contactor relay types	DC operated	NSL..S	
Coil operating limits	DC supply		
acc. to IEC 60947-5-1		0.85...1.1 x U _c (at $\theta \leq 60\text{ °C}$); U _c (at $\theta \leq 70\text{ °C}$)	
DC control voltage			
Rated control circuit voltage U _c		12...240 V DC	
Coil consumption	Average pull-in value	3 W	
	Average holding value	3 W	
Drop-out voltage		Approx. 10...40 % of U _c	
Coil time constant	Open	L/R	12 ms
	Closed	L/R	40 ms
Operating time			
Between coil energization and:	N.O. contact closing	36...59 ms	
	N.C. contact opening	31...53 ms	
Between coil de-energization and:	N.O. contact opening (1)	13...17 ms	
	N.C. contact closing (1)	15...20 ms	
(1) The use of RT5 surge suppressor increases opening time by a factor of 1.1 to 1.2.			

Mounting characteristics and conditions for use

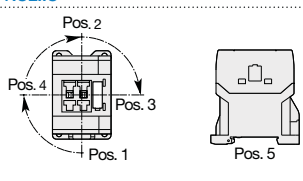
Contactor relay types	AC operated	NS..S
	DC operated	NSL..S
Mounting positions		
Mounting distances	The contactor relays can be assembled side by side.	
Fixing	On rail according to IEC 60715, EN 60715	35 x 7.5 mm or 35 x 15 mm
	By screws (not supplied)	2 x M4 screws placed diagonally

NS..S and NSL..S contactor relays - with spring terminals



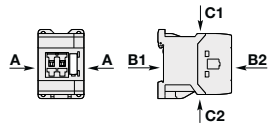

Technical data

General technical data

Contactor relay types	AC operated	NS..S
	DC operated	NSL..S
Rated insulation voltage U_i		690 V
acc. to IEC 60947-5-1		600 V
acc. to UL / CSA		6 kV
Rated impulse withstand voltage U_{imp}		
Ambient air temperature close to contactor relay		
Operation in free air		-40...+70 °C
Storage		-60...+80 °C
Climatic withstand		Category B according to IEC 60947-1 Annex Q
Maximum operating altitude (without derating)		3000 m
Mechanical durability		
Number of operating cycles		20 millions operating cycles
Max. switching frequency		3600 cycles/h
Shock withstand		1/2 sinusoidal shock for 11 ms: no change in contact position, closed or open position
acc. to IEC 60068-2-27 and EN 60068-2-27	Shock direction	
Mounting position 1		
		NS contactor relays - AC operated
		NSL contactor relays - DC operated
	A	20 g
	B1	5 g
	B2	15 g
	C1	19 g closed position / 8 g open position
	C2	16 g closed position / 13 g open position
Vibration withstand		5...300 Hz
acc. to IEC 60068-2-6		3 g closed position / 2 g open position



Connecting characteristics

Contactor relay types	AC operated	NS..S
	DC operated	NSL..S
Main terminals		
		Spring terminals
Connection capacity (min. ... max.)		
Pole and coil terminals		
 Rigid solid	1 x	0.75...2.5 mm ²
	2 x	0.75...2.5 mm ²
 Flexible with non insulated ferrule	1 x	0.75...2.5 mm ²
	2 x	0.75...2.5 mm ²
 Flexible with insulated ferrule	1 x	0.75...1.5 mm ²
	2 x	0.75...1.5 mm ²
Connection capacity acc. to UL / CSA	1 or 2 x	AWG 18...14
Stripping length		10 mm
Degree of protection		
acc. to IEC 60947-1 / EN 60947-1 and IEC 60529 / EN 60529		
All terminals		IP20
Screwdriver type		Flat Ø 3.5

Notes

A series of horizontal dotted lines for taking notes.

NS..S contactor relays - with spring terminals

Terminal marking and positioning

NS..S contactor relays - AC operated

Standard devices without addition of auxiliary contact blocks

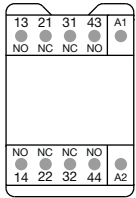

NS22ES

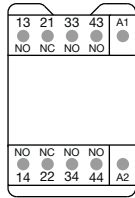

NS31ES

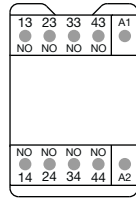

NS40ES

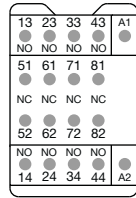

NS44ES

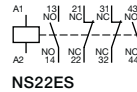

NS22ES

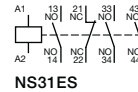

NS31ES

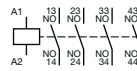

NS40ES

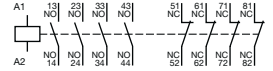

NS44ES

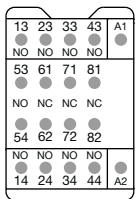

NS53ES

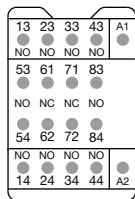

NS62ES

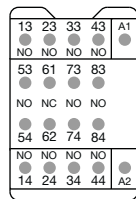

NS71ES

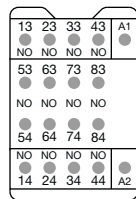

NS80ES

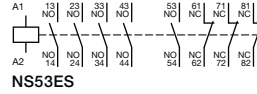

NS53ES

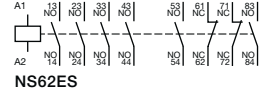

NS62ES

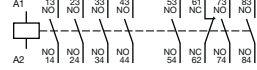

NS71ES

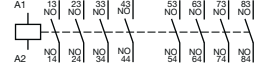

NS80ES

6

Other possible contact combinations with auxiliary contact blocks added by the user

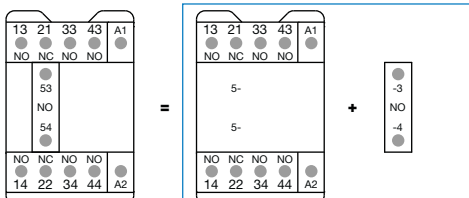

Combination 41E = NS31ES + CA3-10S

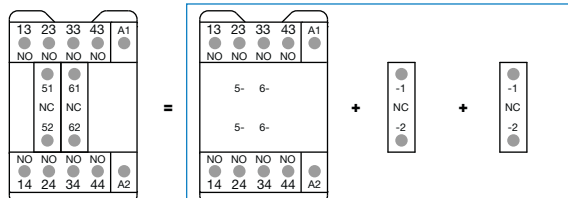

Combination 42E = NS40ES + CA3-01S + CA3-01S



Combination 41E

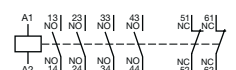

Combination 42E

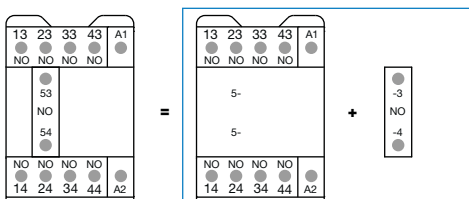

Combination 50E = NS40ES + CA3-10S

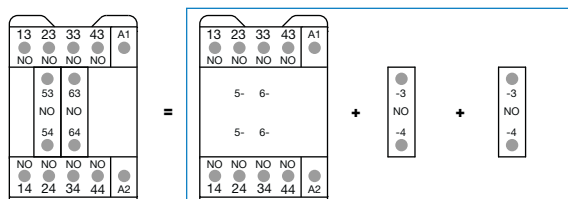

Combination 60E = NS40ES + CA3-10S + CA3-10S

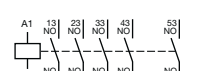

Combination 50E

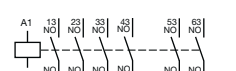

Combination 60E

CA3..S 1-pole auxiliary contact blocks

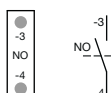

CA3-10S



CA3-01S

NSL..S contactor relays - with spring terminals

Terminal marking and positioning

NSL..S contactor relays - DC operated (the polarity A1+, A2- must be respected)

Standard devices without addition of auxiliary contact blocks

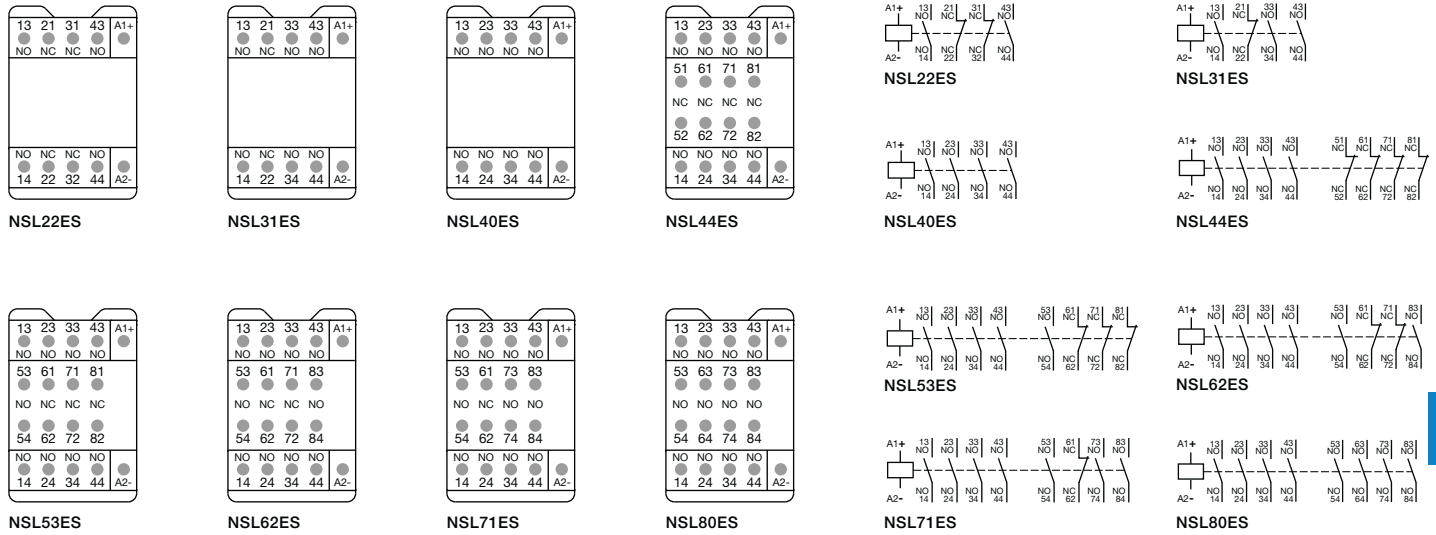

6

Other possible contact combinations with auxiliary contact blocks added by the user

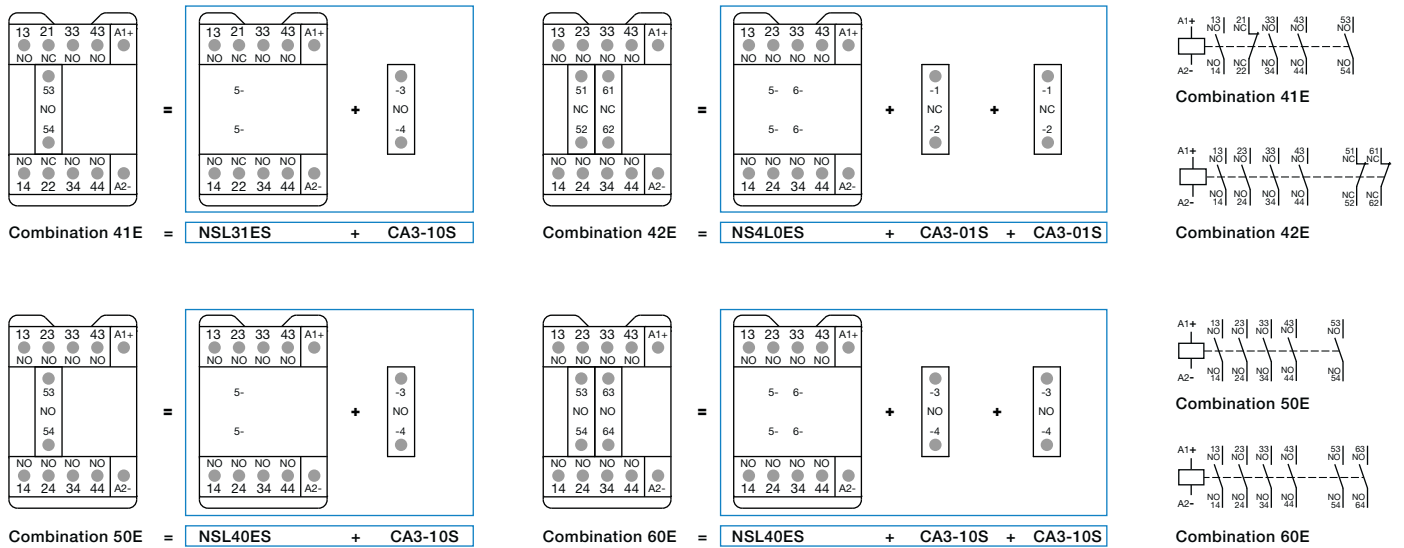

CA3..S 1-pole auxiliary contact blocks



NS..S contactor relays - with spring terminals

Main dimensions mm, inches

4-pole contactor relays

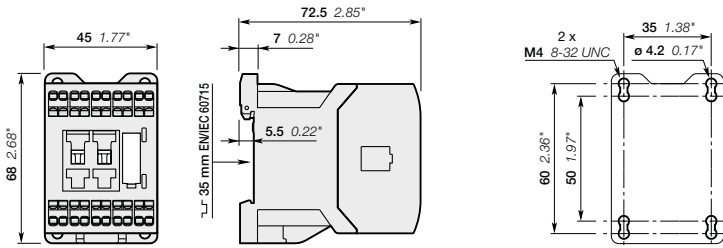

NS22ES, NS31ES, NS40ES

6

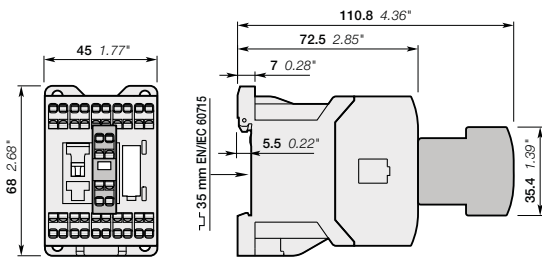

NS22ES, NS31ES, NS40ES
+ CA3..S front-mounted 1-pole auxiliary contact block

8-pole contactor relays

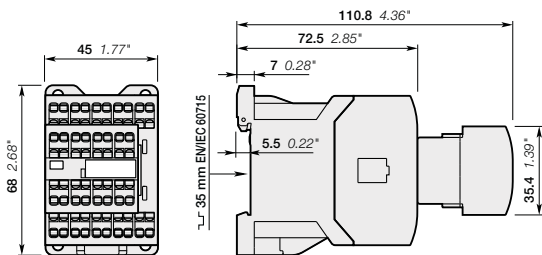

NS44ES, NS53ES, NS62ES, NS71ES, NS80ES

NSL..S contactor relays - with spring terminals

Main dimensions mm, inches

4-pole contactor relays

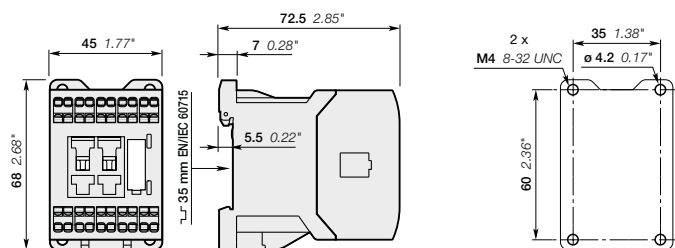

NSL22ES, NSL31ES, NSL40ES

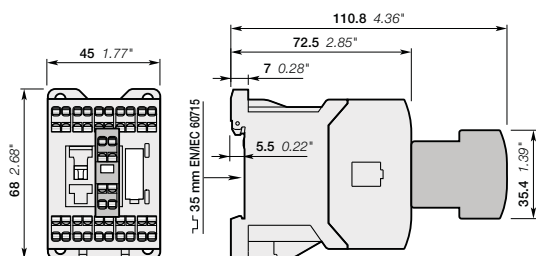

NSL22ES, NSL31ES, NSL40ES

+ CA3..S front-mounted 1-pole auxiliary contact block

8-pole contactor relays

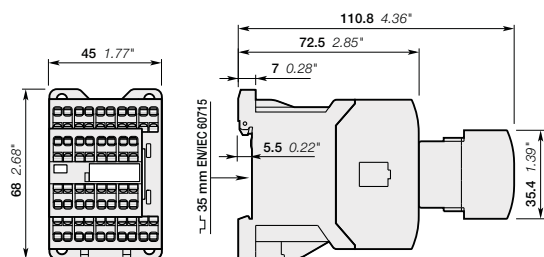

NSL44ES, NSL53ES, NSL62ES, NSL71ES, NSL80ES

Auxiliary contact blocks - with spring terminals

Accessories



CA3-10S

Description

The auxiliary contact blocks are used for the operation of auxiliary circuits and control circuits. CA3 1-pole auxiliary contact blocks, designed for standard industrial environments, are equipped with:

- N.O. or N.C. contacts.
- spring-type connecting terminals.

All 1-pole auxiliary contact blocks are protected against accidental direct contact and bear the corresponding function marking.

A maximum of two 1-pole auxiliary contact blocks can be front-mounted on 1-stack contactors or 1-stack contactor relays.

Ordering details

For contactors	For contactor relays	Contact blocks	Type	Order code	Pkg qty	Weight (1 pce)
						kg

1-pole auxiliary contact blocks with spring terminals

AS09..S ... AS16..S	NS..S, NSL..S	1 -	CA3-10S	1SBN011019T1010	10	0.011
ASL09..S ... ASL16..S		- 1	CA3-01S	1SBN011019T1001	10	0.011

Main dimensions mm, inches

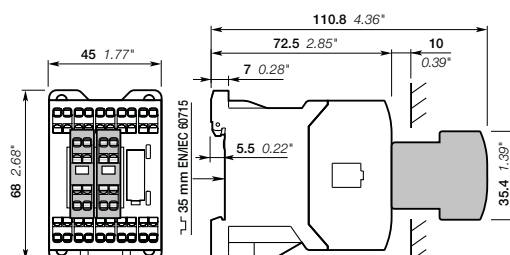

Auxiliary contact blocks - with spring terminals

Front mounting

Technical data

Types	1-pole CA3..S
-------	---------------







Contact utilization characteristics according to IEC

Standards	IEC 60947-5-1 and EN 60947-5-1	
Rated insulation voltage U_i acc. to IEC 60947-5-1	690 V	
Rated impulse withstand voltage U_{imp}	6 kV	
Rated operational voltage U_e max.	690 V	
Conventional thermal current I_{th} - $\theta \leq 40$ °C	10 A	
le / Rated operational current AC-15 acc. to IEC 60947-5-1	24-127 V 50/60 Hz	6 A
	220-240 V 50/60 Hz	4 A
	400-440 V 50/60 Hz	3 A
	500 V 50/60 Hz	2 A
	690 V 50/60 Hz	2 A
Making capacity	10 x I_e AC-15 acc. to IEC 60947-5-1	
Breaking capacity	10 x I_e AC-15 acc. to IEC 60947-5-1	
le / Rated operational current DC-13 acc. to IEC 60947-5-1	24 V DC	6 A / 144 W
	48 V DC	2.8 A / 134 W
	72 V DC	1 A / 72 W
	110 V DC	0.55 A / 60 W
	125 V DC	0.55 A / 69 W
	220 V DC	0.27 A / 60 W
	250 V DC	0.27 A / 68 W
Short-circuit protection device gG type fuse	10 A	
Rated short-time withstand current I_{sc} $\theta = 40$ °C	for 1.0 s	100 A
	for 0.1 s	140 A
Minimum switching capacity with failure rate acc. to IEC 60947-5-4	12 V / 3 mA	
Power dissipation per pole at 6 A	0.1 W	
Mechanical durability	Number of operating cycles	10 millions operating cycles
	Max. switching frequency	3600 cycles/h
	Max. electrical switching frequency	AC-15
AC-13		900 cycles/h
Mechanically linked contact acc. to annex L of IEC 60947-5-1	Additional N.O. or N.C. auxiliary contacts (CA3..S aux. contact blocks) are mechanically linked contacts	
Mirror contacts acc. to annex F of IEC 60947-4-1	Additional N.C. auxiliary contacts (CA3..S aux. contact blocks) are mirror contacts	

Contact utilization characteristics according to UL / CSA

Standards	UL 508, CSA C22.2 N°14
Max. operational voltage	690 V AC, 250 V DC
Pilot duty	A600, Q300
AC thermal rated current	10 A
AC maximum volt-ampere making	7200 VA
AC maximum volt-ampere breaking	720 VA
DC thermal rated current	2.5 A
DC maximum volt-ampere making-breaking	69 VA

Connecting characteristics

Connection capacity (min. ... max.)		
	Rigid solid	1 x 0.75...2.5 mm ²
	Flexible with non insulated ferrule	2 x 0.75...2.5 mm ²
		1 x 0.75...2.5 mm ²
	Flexible with insulated ferrule	2 x 0.75...2.5 mm ²
		1 x 0.75...1.5 mm ²
		2 x 0.75...1.5 mm ²
Connection capacity acc. to UL / CSA		1 or 2 x AWG 18...14
Stripping length		10 mm
Degree of protection acc. to IEC 60947-1 / EN 60947-1 and IEC 60529 / EN 60529	IP20	
Screw terminals	Spring terminals	
All terminals	Spring terminals	
Screwdriver type	Flat Ø 3.5	

Auxiliary contact blocks for AS09..S ... AS16..S, ASL09..S ... ASL16..S contactors and NS, NSL contactor relays - with spring terminals

Electrical durability

Electrical durability for AC-15 utilization category - $U_e \leq 400\text{ V}$

AC-15 utilization category according to IEC 60947-5-1 / EN 60947-5-1:

- making current: $10 \times I_e$ with $\cos \phi = 0.7$ and U_e
- breaking current: I_e with $\cos \phi = 0.4$ and U_e .

This curve represents the electrical durability of the built-in or add-on auxiliary contacts in relation to the breaking current.

The curve has been drawn for resistive and inductive loads up to 400 V:

- AS09..S ... AS16..S and ASL09..S ... ASL16..S contactor built-in auxiliary contacts
- 1-pole CA3..S
- NS..S and NSL..S contactor relays.

Millions of
operating
cycles

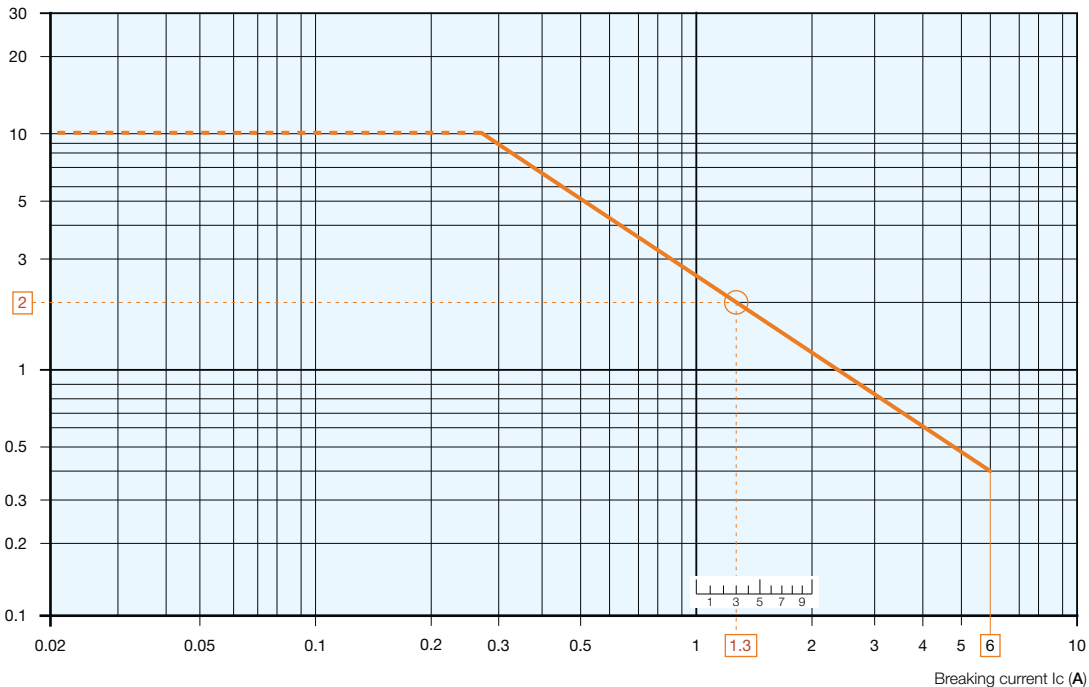

Example:

Breaking current = 1.3 A

On the opposite curve at intersection "○" 1.3 A the corresponding value for the electrical durability is approximately 2 millions operating cycles.

Notes

A series of horizontal dotted lines for taking notes, spanning the width of the page.

Surge suppressors for contactor coils

Accessories

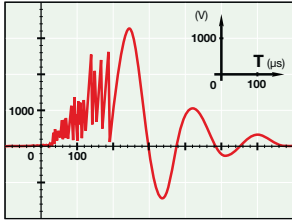

Description

The operation of inductive circuits causes overvoltages, in particular on opening the contactor coil. The electromagnetic energy stored in the coil during contactor closing is restored on opening in the form of surges, the slope and amplitude of which may rise to several kilovolts. A number of drawbacks are observed ranging from interference on the electronic devices to the breakdown of insulators and even the destruction of certain sensitive components.

The graph opposite reproduces the oscillogram showing voltage discharges at the terminals of a 42 V / 50 Hz coil without peak clipping. The coil was switched by 8 series-connected poles of a contactor relay. Following a burst of discharges with a very steep slope, a damped oscillation emerges with a peak value of 3500 V.

Overvoltage Factor

The overvoltage factor k is defined as the ratio of the maximum overvoltage peak value \hat{U}_s to the peak value \hat{U}_c of the coil rated control voltage U_c :

$$k = \frac{\hat{U}_s \text{ max.}}{\hat{U}_c} \quad \text{in DC} \quad k = \frac{\hat{U}_s \text{ max.}}{U_c} \quad \text{in AC} \quad k = \frac{\hat{U}_s \text{ max.}}{U_c \sqrt{2}}$$

For example the following is obtained for the above graph:

$$k = \frac{3500}{42 \sqrt{2}} \approx 60$$

To reduce the harmful effects of these overvoltages, ABB has developed a range of surge suppressors designed to reduce the k factor defined above and to limit or even completely eliminate the high pre-damping voltage frequencies.

Each case is different, but the technical data tolerances and generous sizing of parts have enabled us to reduce the number of variants.

We have chosen the following solutions: transil diodes, varistors and RC blocks.

Note: A varistor is a resistor whose value decreases to a very large extent when a certain voltage is applied at its terminals.

Ordering details

For contactors	For contactor relays	Rated control circuit voltage - U_c			Type	Order code	Pkg qty	Weight (1 pce) kg
		V	DC	AC				
AS..S, ASL..S	NS..S, NSL..S	24...50	●	●	RV5/50	1SBN050010R1000	2	0.015
		50...133	●	●	RV5/133	1SBN050010R1001	2	0.015
		110...250	●	●	RV5/250	1SBN050010R1002	2	0.015
		250...440	●	●	RV5/440	1SBN050010R1003	2	0.015
AS..S	NS..S	24...50	-	●	RC5-1/50	1SBN050100R1000	2	0.012
		50...133	-	●	RC5-1/133	1SBN050100R1001	2	0.012
		110...250	-	●	RC5-1/250	1SBN050100R1002	2	0.012
		250...440	-	●	RC5-1/440	1SBN050100R1003	2	0.012
ASL..S	NSL..S	12...32	●	-	RT5/32	1SBN050020R1000	2	0.015
		25...65	●	-	RT5/65	1SBN050020R1001	2	0.015
		50...90	●	-	RT5/90	1SBN050020R1002	2	0.015
		77...150	●	-	RT5/150	1SBN050020R1003	2	0.015
		150...264	●	-	RT5/264	1SBN050020R1004	2	0.015

Main dimensions mm, inches

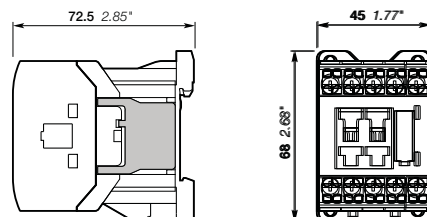

Easy connection to the coil terminals
(parallel mounting)
Clip-on for both fixing and connection.

No additional space
Clipped onto the right side part of the contactor base without changing contactor overall dimensions and keeping a free access to coil terminals.

1SBC101499S0201

Surge suppressors for contactor coils

Technical data

Varistor	RV5/50	RV5/133	RV5/250	RV5/440
Rated control circuit voltage U_c	24...50 V AC	50...133 V AC	110...250 V AC	250...440 V AC
Residual overvoltage (clipping voltage)	24...50 V DC	50...133 V DC	110...250 V DC	250...440 V DC
	132 V AC	270 V AC	480 V AC	825 V AC
	132 V DC	270 V DC	480 V DC	825 V DC
Opening time growth factor	none			
Operating temperature	-20...+70 °C			
Advantages	High energy absorption: good damping - Unpolarized system.			
Drawback	Clipping as from U_{vdr}^* , thus voltage front up to this point.			
	* U_{vdr} = Varistor operating voltage (voltage dependent resistor), tolerance $\pm 10\%$.			

RC type	RC5-1/50	RC5-1/133	RC5-1/250	RC5-1/440
Rated control circuit voltage U_c	24...50 V AC	50...133 V AC	110...250 V AC	250...440 V AC
Residual overvoltage (clipping voltage)	2 to 3 x U_c max.			
Opening time growth factor	2...3			
Operating temperature	-20...+70 °C			
Advantages	Very fast clipping - Attenuation of steep fronts and thus of high frequencies.			

Transil diode	RT5/32	RT5/65	RT5/90	RT5/150	RT5/264
Rated control circuit voltage U_c	12...32 V DC	25...65 V DC	50...90 V DC	77...150 V DC	150...264 V DC
Residual overvoltage (clipping voltage)	50 V DC	100 V DC	150 V DC	210 V DC	390 V DC
Opening time growth factor	1.1...1.2				
Operating temperature	-20...+70 °C				
Advantages	Good energy absorption - Unpolarized system - Simple, reliable system.				
Drawback	Delay on drop out which does not however reduce contactor breaking capacity.				

Wiring diagrams

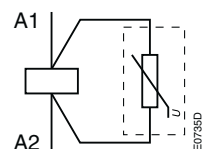

Varistor

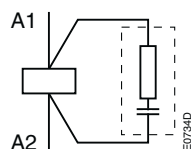

RC type

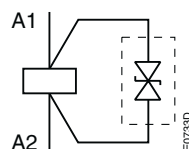

Transil diode

Connecting links for starting solutions and other accessories



BEA16-3U

Connecting links

The BEA16-3U insulated connecting links are used to connect an AS..S AC operated contactor or an ASL..S DC operated contactor with a manual motor starter.

The connecting link ensure the electrical and mechanical connection between the contactor and the manual motor starter.

Ordering details

For contactors	Manual motor starter	Type	Order code	Pkg qty	Weight (1 pce) kg
AS09..S ... AS16..S	MS116-0.16 ... MS116-16	BEA16-3U	1SBN081020R1000	1	0.045
ASL09..S ... ASL16..S	MS132-0.16 ... MS132-16				



BDT4

Test block

BDT4 test block is suitable for switching on contactor off-load.

Marking on the block indicates the contactor type to fit with.

Ordering details

For contactors	Type	Order code	Pkg qty	Weight (1 pce) kg
AS..S, ASL..S, NS..S, NSL..S	BDT4	1SBN110122T1000	10	0.007



BA4

Function markers

Box of 16 blank cards (16 markers by card) printable on HTP500 thermal transfer printer and AMS 500 marking table to identify your contactors, overload relays or manual motor starters.

Marker dimensions: 7 x 20 mm (.276" x .787").

Ordering details

For contactors	Type	Order code	Pkg qty	Weight (1 pce) kg
AS..S, ASL..S, NS..S, NSL..S	BA4	1SNA235156R2700	16	0.011
AMS 500 support plate for 8 BA4	SPRC 1	1SNA360010R1500	1	0.220
HTP500 support plate	HTP500-BA4	1SNA235712R2400	1	0.290

Voltage code table

The below tables indicate the available coil voltages and corresponding digits for order codes. When placing an order, please give either type or order code. Select a standard contactor from ordering detail pages. Change the **coil voltage code** in the type or in the order code according to the table below. Example: for contactor AS09-30-10S and coil 42 V 50/60 Hz, type is AS09-30-10S-**21** and order code is 1SBL101004R**21**10.

3-pole contactors - with spring terminals

Type AS16 - 30 - 10 S - 26

Auxiliary contacts
N.O. N.C.

Main contacts
N.O. N.C.

Order code 1SBL121004R 26 10

Contactor type
AS AC operated
ASL DC operated

Contactor with spring terminal

	AC coil code	
	50 Hz	60 Hz
20	24 V	24 V
21	42 V	42 V
22	48 V	48 V
23	110 V	110 V
24	115 V	115 V
16	-	120 V
25	220 V	220 V
26	230 V	230 V
27	240 V	240 V
17	-	277 V
13	380 V	-
28	400 V	400 V
29	415 V	415 V

DC coil code	
80	12 V
81	24 V
83	48 V
84	60 V
86	110 V
87	125 V
88	220 V
89	240 V

Contactor relays - with spring terminals

Type NS 40 E S - 26

Contactor with spring terminal

N.O. N.C.
Number contacts

Order code 1SBH101004R 26 40

Contactor type
NS AC operated
NSL DC operated

	AC coil code	
	50 Hz	60 Hz
20	24 V	24 V
21	42 V	42 V
22	48 V	48 V
23	110 V	110 V
24	115 V	115 V
16	-	120 V
25	220 V	220 V
26	230 V	230 V
27	240 V	240 V
17	-	277 V
13	380 V	-
28	400 V	400 V
29	415 V	415 V

DC coil code	
80	12 V
81	24 V
83	48 V
84	60 V
86	110 V
87	125 V
88	220 V
89	240 V



AF..S 3-pole contactors and NF..S contactor relays with spring terminals

AF..S 3-pole contactors - with spring terminals

Overview 6/44

1-stack contactors

AF09..S ... AF26..S AC / DC operated 6/46

AF09Z..S ... AF26Z..S AC / DC operated - low consumption 6/47

2-stack contactors

AF09..S ... AF26..S AC / DC operated 6/48

AF09Z..S ... AF26Z..S AC / DC operated - low consumption 6/49

Main accessories 6/50

Technical data 6/52

Electrical durability 6/57

Terminal marking and positioning 6/61

Main dimensions 6/62

NF..S contactor relays - with spring terminals

Overview 6/66

4-pole contactor relays

NF..S AC / DC operated 6/68

NFZ..S AC / DC operated - low consumption 6/69

8-pole contactor relays

NF..S AC / DC operated 6/70

NFZ..S AC / DC operated - low consumption 6/71

Main accessories 6/72

Technical data 6/74

Terminal marking and positioning 6/77

Main dimensions 6/78

Accessories

Auxiliary contact blocks - with spring terminals 6/80

Electronic timers - with spring terminals 6/84

Other accessories 6/87

Voltage code table 6/88

3-pole contactors - with spring terminals

Main accessories

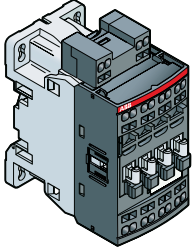

AF09..S ... AF16..S
3-pole contactors

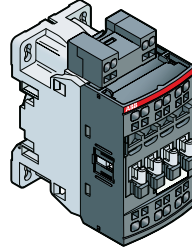

AF26..S
3-pole contactors

6

Main accessories for contactors

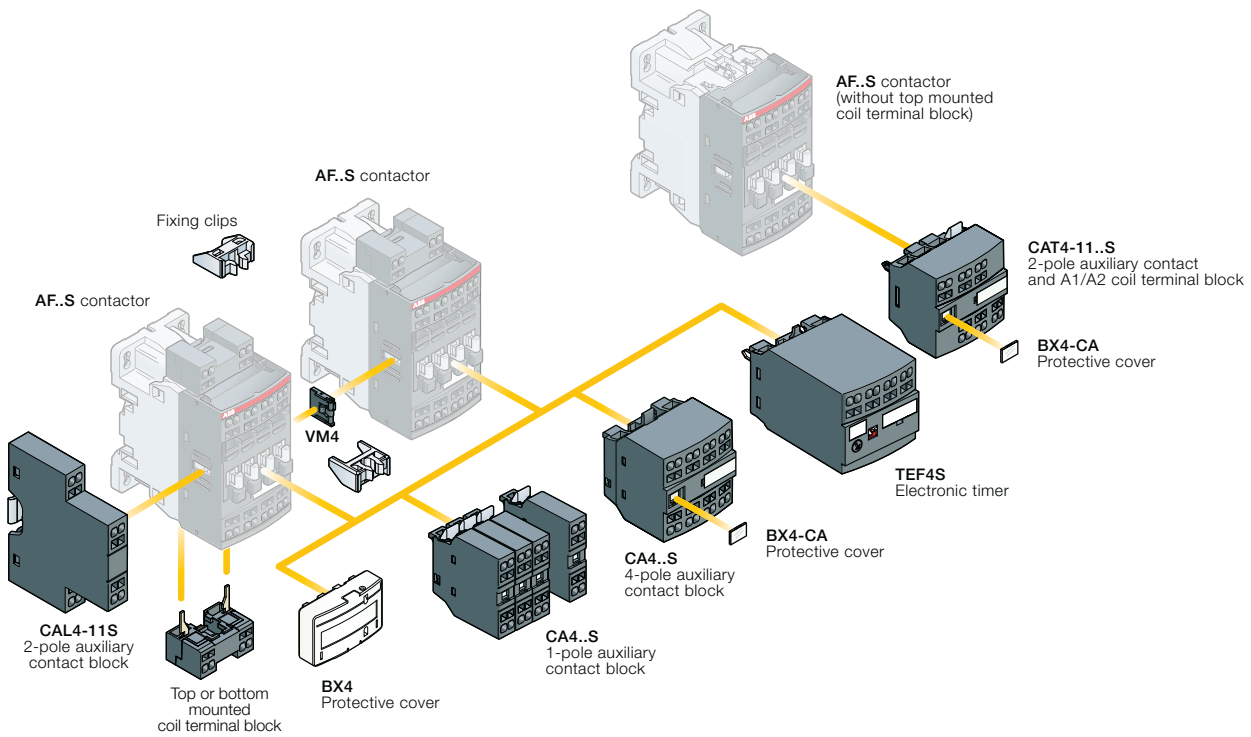

3-pole contactors - with spring terminals



Spring terminals



	AC / DC Control voltage	AF09..S	AF12..S	AF16..S	AF26..S
--	-------------------------	---------	---------	---------	---------

Switching of 3-phase cage motors

	IEC	AC-3	Rated operational power	400 V	4 kW	5.5 kW	7.5 kW	11 kW	
			Rated operational current	$\theta \leq 60\text{ }^{\circ}\text{C}$	400 V	9 A	12 A	18 A	26 A
				$\theta \leq 60\text{ }^{\circ}\text{C}$	415 V	9 A	12 A	18 A	26 A
	UL/CSA	3-phase motor rating		440-480 V	5 hp	7.5 hp	10 hp	-	
			NEMA size		00	0	-	-	

Switching of resistive circuits

	IEC	AC-1	Rated operational current	$\theta \leq 40\text{ }^{\circ}\text{C}$	690 V	22 A	24 A	24 A	35 A
			With conductor cross-sectional area	$\theta \leq 60\text{ }^{\circ}\text{C}$	690 V	18 A	20 A	20 A	30 A
				$\theta \leq 70\text{ }^{\circ}\text{C}$	690 V	15 A	16 A	16 A	25 A
	UL/CSA	General use rating		600 V AC	20 A	20 A	20 A	-	
			With conductor cross-sectional area		AWG 12	AWG 12	AWG 12	-	

Main accessories

Auxiliary contact blocks	Front mounting		1-pole CA4-10S or CA4-01S 4-pole CA4..S
	Side mounting		2-pole CAT4-11..S (with coil front connection)
Interlock	Mechanical		VM4 Including 2 fixing clips
Additional coil terminal block			LDC4S
Protective covers			BX4 For all 1-stack contactors BX4-CA For 4-pole CA4..S and 2-pole CAT4..S auxiliary contact blocks

AF09..S ... AF26..S 3-pole contactors - with spring terminals

4 to 11 kW

AC / DC operated



AF09-30-10S

1SBC101099F0014



AF26-30-00S

1SBC101100F0014

Description

AF09..S ... AF26..S contactors are mainly used for controlling 3-phase motors and power circuits up to 690 V AC and 220 V DC. These contactors are of the block type design with 3 main poles:

- control circuit: AC or DC operated with electronic coil interface accepting a wide control voltage range (e.g. 100...250 V AC and DC), only 4 control voltage ranges covering 24...500 V 50/60 Hz and 20...500 V DC
- can manage large control voltage variations
- reduced panel energy consumption
- very distinct closing and opening.
- built-in surge suppression
- add-on auxiliary contact blocks for front or side mounting and a wide range of accessories.

Ordering details

IEC		UL/CSA		Rated control circuit voltage		Auxiliary contacts fitted	Type	Order code	Weight					
Rated operational power	current $\theta \leq 40^\circ\text{C}$	3-phase motor rating	General use rating	Uc min. ... Uc max.										
400 V AC-3	AC-1	480 V	600 V AC	V 50/60 Hz	V DC				Pkg (1 pce)					
kW	A	hp	A						kg					
4	22	5	20	24...60	-	(1)	1 0	AF09-30-10S-41	1SBL137004R4110	0.270				
					0 1	AF09-30-01S-41	1SBL137004R4101	0.270						
				48...130	48...130	1 0	AF09-30-10S-12	1SBL137004R1210	0.270					
						0 1	AF09-30-01S-12	1SBL137004R1201	0.270					
						1 0	AF09-30-10S-13	1SBL137004R1310	0.270					
						0 1	AF09-30-01S-13	1SBL137004R1301	0.270					
				100...250	100...250	1 0	AF09-30-10S-14	1SBL137004R1410	0.310					
						0 1	AF09-30-01S-14	1SBL137004R1401	0.310					
				5.5	24	7.5	20	24...60	-	(1)	1 0	AF12-30-10S-41	1SBL157004R4110	0.270
									0 1	AF12-30-01S-41	1SBL157004R4101	0.270		
48...130	48...130	1 0	AF12-30-10S-12					1SBL157004R1210	0.270					
		0 1	AF12-30-01S-12					1SBL157004R1201	0.270					
		1 0	AF12-30-10S-13					1SBL157004R1310	0.270					
		0 1	AF12-30-01S-13					1SBL157004R1301	0.270					
100...250	100...250	1 0	AF12-30-10S-14					1SBL157004R1410	0.310					
		0 1	AF12-30-01S-14					1SBL157004R1401	0.310					
7.5	24	10	20					24...60	-	(1)	1 0	AF16-30-10S-41	1SBL177004R4110	0.270
									0 1	AF16-30-01S-41	1SBL177004R4101	0.270		
				48...130	48...130	1 0	AF16-30-10S-12	1SBL177004R1210	0.270					
						0 1	AF16-30-01S-12	1SBL177004R1201	0.270					
						1 0	AF16-30-10S-13	1SBL177004R1310	0.270					
						0 1	AF16-30-01S-13	1SBL177004R1301	0.270					
				100...250	100...250	1 0	AF16-30-10S-14	1SBL177004R1410	0.310					
						0 1	AF16-30-01S-14	1SBL177004R1401	0.310					
				11	35	-	-	24...60	-	(1)	0 0	AF26-30-00S-41	1SBL237004R4100	0.320
									0 0	AF26-30-00S-12	1SBL237004R1200	0.320		
48...130	48...130	0 0	AF26-30-00S-13					1SBL237004R1300	0.320					
		0 0	AF26-30-00S-14					1SBL237004R1400	0.360					

(1) For 24...60 V 50/60 Hz - 20...60 V DC, use AF..-30-..S-11 (see voltage code table).
AF..-30-..S-11 not suitable for direct control by PLC-output.

Main dimensions mm, inches

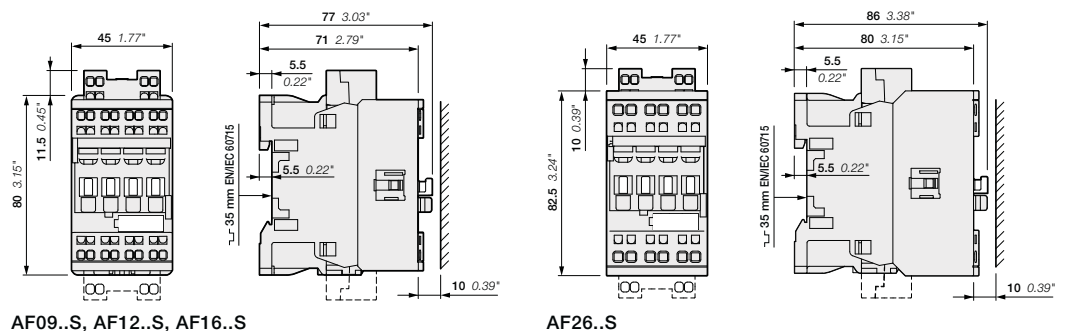

AF09..S, AF12..S, AF16..S

AF26..S

1SBC101688S0201 - Rev. A

AF09Z..S ... AF26Z..S 3-pole contactors - with spring terminals

4 to 11 kW

AC / DC operated - low consumption



AF09Z-30-10S



AF26Z-30-00S

Description

AF09Z..S ... AF26Z..S contactors are mainly used for controlling 3-phase motors and power circuits up to 690 V AC and 220 V DC. These contactors are of the block type design with 3 main poles:

- control circuit: AC or DC operated with electronic coil interface accepting a wide control voltage range (e.g. 100...250 V AC and DC), only 4 control voltage ranges covering 24...250 V 50/60 Hz and 12...250 V DC
- can manage large control voltage variations
- allow direct control by PLC-output ≥ 24 V DC 500 mA
- reduced panel energy consumption
- very distinct closing and opening
- can withstand short voltage dips and voltage sags (SEMI F47-0706 conditions of use on request).
- built-in surge suppression
- add-on auxiliary contact blocks for front or side mounting and a wide range of accessories.

Ordering details

IEC Rated operational power 400 V AC-3 kW	operational current $\theta \leq 40$ °C A	UL/CSA 3-phase motor rating 480 V hp	General use rating 600 V AC A	Rated control circuit voltage Uc min. ... Uc max.		Auxiliary contacts fitted	Type	Order code	Weight Pkg (1 pce) kg
				V 50/60 Hz	V DC				
4	22	5	20	-	12...20	1 0 0 1	AF09Z-30-10S-20	1SBL136004R2010	0.310
							AF09Z-30-01S-20	1SBL136004R2001	0.310
							AF09Z-30-10S-21	1SBL136004R2110	0.310
							AF09Z-30-01S-21	1SBL136004R2101	0.310
							AF09Z-30-10S-22	1SBL136004R2210	0.310
							AF09Z-30-01S-22	1SBL136004R2201	0.310
							AF09Z-30-10S-23	1SBL136004R2310	0.310
							AF09Z-30-01S-23	1SBL136004R2301	0.310
5.5	24	7.5	20	-	12...20	1 0 0 1	AF12Z-30-10S-20	1SBL156004R2010	0.310
							AF12Z-30-01S-20	1SBL156004R2001	0.310
							AF12Z-30-10S-21	1SBL156004R2110	0.310
							AF12Z-30-01S-21	1SBL156004R2101	0.310
							AF12Z-30-10S-22	1SBL156004R2210	0.310
							AF12Z-30-01S-22	1SBL156004R2201	0.310
							AF12Z-30-10S-23	1SBL156004R2310	0.310
							AF12Z-30-01S-23	1SBL156004R2301	0.310
7.5	24	10	20	-	12...20	1 0 0 1	AF16Z-30-10S-20	1SBL176004R2010	0.310
							AF16Z-30-01S-20	1SBL176004R2001	0.310
							AF16Z-30-10S-21	1SBL176004R2110	0.310
							AF16Z-30-01S-21	1SBL176004R2101	0.310
							AF16Z-30-10S-22	1SBL176004R2210	0.310
							AF16Z-30-01S-22	1SBL176004R2201	0.310
							AF16Z-30-10S-23	1SBL176004R2310	0.310
							AF16Z-30-01S-23	1SBL176004R2301	0.310
11	35	-	-	-	12...20	0 0 0 0	AF26Z-30-00S-20	1SBL236004R2000	0.360
							AF26Z-30-00S-21	1SBL236004R2100	0.360
							AF26Z-30-00S-22	1SBL236004R2200	0.360
							AF26Z-30-00S-23	1SBL236004R2300	0.360

Note: Only AF.Z..S contactors with DC control voltage 12...20 V DC need to respect the connection polarities indicated close to the coil terminals: A1+ for the positive pole and A2- for the negative pole.

Main dimensions mm, inches

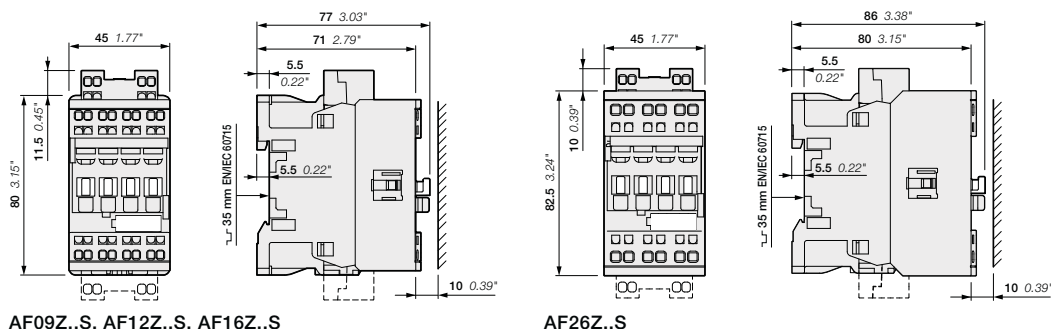

AF09Z..S, AF12Z..S, AF16Z..S

AF26Z..S

AF09..S ... AF26..S 2-stack 3-pole contactors - with spring terminals

4 to 11 kW

AC / DC operated



AF09-30-22S

1SBC10110F0014

Description

- AF09..S ... AF26..S contactors are mainly used for controlling 3-phase motors and power circuits up to 690 V AC and 220 V DC. These contactors are of the block type design with 3 main poles (1st stack):
- 2nd stack with permanently fixed auxiliary contact block. The built-in auxiliary contact elements are mechanically linked (side-marked symbol) and the N.C. auxiliary contacts are mirror contacts
 - control circuit: AC or DC operated with electronic coil interface accepting a wide control voltage range (e.g. 100...250 V AC and DC) only 4 control voltage ranges covering 24...500 V 50/60 Hz and 20...500 V DC
 - can manage large control voltage variations
 - reduced panel energy consumption
 - very distinct closing and opening.
 - built-in surge suppression
 - add-on auxiliary contact blocks for side mounting and a wide range of accessories.

Ordering details

IEC Rated operational power	UL/CSA 3-phase General use rating	3-phase motor rating	General use rating	Rated control circuit voltage		Auxiliary contacts fitted	Type	Order code	Weight Pkg (1 pce)
				Uc min. ... Uc max.					
400 V AC-3	AC-1	hp	A	V 50/60 Hz	V DC				kg
kW	A								
4	22	5	20	24...60	-	(1) 2 2	AF09-30-22S-41	1SBL137004R4122	0.320
				48...130	48...130	2 2	AF09-30-22S-12	1SBL137004R1222	0.320
				100...250	100...250	2 2	AF09-30-22S-13	1SBL137004R1322	0.320
				250...500	250...500	2 2	AF09-30-22S-14	1SBL137004R1422	0.360
5.5	24	7.5	20	24...60	-	(1) 2 2	AF12-30-22S-41	1SBL157004R4122	0.320
				48...130	48...130	2 2	AF12-30-22S-12	1SBL157004R1222	0.320
				100...250	100...250	2 2	AF12-30-22S-13	1SBL157004R1322	0.320
				250...500	250...500	2 2	AF12-30-22S-14	1SBL157004R1422	0.360
7.5	24	10	20	24...60	-	(1) 2 2	AF16-30-22S-41	1SBL177004R4122	0.320
				48...130	48...130	2 2	AF16-30-22S-12	1SBL177004R1222	0.320
				100...250	100...250	2 2	AF16-30-22S-13	1SBL177004R1322	0.320
				250...500	250...500	2 2	AF16-30-22S-14	1SBL177004R1422	0.360
11	35	-	-	24...60	-	(1) 1 1	AF26-30-11S-41	1SBL237004R4111	0.360
						2 2	AF26-30-22S-41	1SBL237004R4122	0.380
				48...130	48...130	1 1	AF26-30-11S-12	1SBL237004R1211	0.360
						2 2	AF26-30-22S-12	1SBL237004R1222	0.380
				100...250	100...250	1 1	AF26-30-11S-13	1SBL237004R1311	0.360
						2 2	AF26-30-22S-13	1SBL237004R1322	0.380
				250...500	250...500	1 1	AF26-30-11S-14	1SBL237004R1411	0.400
						2 2	AF26-30-22S-14	1SBL237004R1422	0.420

(1) For 24...60 V 50/60 Hz - 20...60 V DC, use AF..-30-..S-11 (see voltage code table).
AF..-30-..S-11 not suitable for direct control by PLC-output.



AF26-30-11S

1SBC101102F0014



AF26-30-22S

1SBC101103F0014

Main dimensions mm, inches

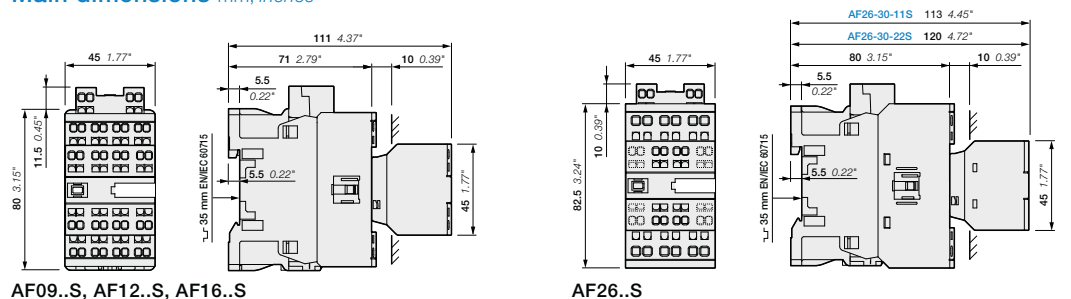

AF09..S, AF12..S, AF16..S

AF26..S

1SBC101710S0201 - Rev. A

AF09Z..S ... AF26Z..S 2-stack 3-pole contactors - with spring terminals 4 to 11 kW AC / DC operated - low consumption



AF09Z-30-22S

1SBC101101F0014



AF26Z-30-11S

1SBC101102F0014



AF26Z-30-22S

1SBC101103F0014

Description

AF09Z..S ... AF26Z..S contactors are mainly used for controlling 3-phase motors and power circuits up to 690 V AC and 220 V DC. These contactors are of the block type design with 3 main poles (1st stack):

- 2nd stack with permanently fixed auxiliary contact block. The built-in auxiliary contact elements are mechanically linked (side-marked symbol) and the N.C. auxiliary contacts are mirror contacts
- control circuit: AC or DC operated with electronic coil interface accepting a wide control voltage range (e.g. 100...250 V AC and DC), only 4 control voltage ranges covering 24...250 V 50/60 Hz and 12...250 V DC
- can manage large control voltage variations
- allow direct control by PLC-output ≥ 24 V DC 500 mA
- reduced panel energy consumption
- very distinct closing and opening
- can withstand short voltage dips and voltage sags (SEMI F47-0706 conditions of use on request).
- built-in surge suppression
- add-on auxiliary contact blocks for side mounting and a wide range of accessories.

Ordering details

IEC Rated operational power 400 V AC-3 kW	UL/CSA 3-phase motor rating 480 V AC-1 $\theta \leq 40$ °C A	General use rating 600 V AC hp A	Rated control circuit voltage Uc min. ... Uc max.		Auxiliary contacts fitted	Type	Order code	Weight Pkg (1 pce) kg	
			V 50/60 Hz	V DC					
4	22	5	20	-	12...20	2 2	AF09Z-30-22S-20	1SBL136004R2022	0.360
				24...60	20...60	2 2	AF09Z-30-22S-21	1SBL136004R2122	0.360
				48...130	48...130	2 2	AF09Z-30-22S-22	1SBL136004R2222	0.360
				100...250	100...250	2 2	AF09Z-30-22S-23	1SBL136004R2322	0.360
5.5	24	7.5	20	-	12...20	2 2	AF12Z-30-22S-20	1SBL156004R2022	0.360
				24...60	20...60	2 2	AF12Z-30-22S-21	1SBL156004R2122	0.360
				48...130	48...130	2 2	AF12Z-30-22S-22	1SBL156004R2222	0.360
				100...250	100...250	2 2	AF12Z-30-22S-23	1SBL156004R2322	0.360
7.5	24	10	20	-	12...20	2 2	AF16Z-30-22S-20	1SBL176004R2022	0.360
				24...60	20...60	2 2	AF16Z-30-22S-21	1SBL176004R2122	0.360
				48...130	48...130	2 2	AF16Z-30-22S-22	1SBL176004R2222	0.360
				100...250	100...250	2 2	AF16Z-30-22S-23	1SBL176004R2322	0.360
11	35	-	-	-	12...20	1 1	AF26Z-30-11S-20	1SBL236004R2011	0.400
				24...60	20...60	2 2	AF26Z-30-22S-20	1SBL236004R2022	0.420
				24...60	20...60	1 1	AF26Z-30-11S-21	1SBL236004R2111	0.400
				24...60	20...60	2 2	AF26Z-30-22S-21	1SBL236004R2122	0.420
				48...130	48...130	1 1	AF26Z-30-11S-22	1SBL236004R2211	0.400
				48...130	48...130	2 2	AF26Z-30-22S-22	1SBL236004R2222	0.420
100...250	100...250	1 1	AF26Z-30-11S-23	1SBL236004R2311	0.400				
100...250	100...250	2 2	AF26Z-30-22S-23	1SBL236004R2322	0.420				

Note: Only AF.Z..S contactors with DC control voltage 12...20 V DC need to respect the connection polarities indicated close to the coil terminals: A1+ for the positive pole and A2- for the negative pole.

Main dimensions mm, inches

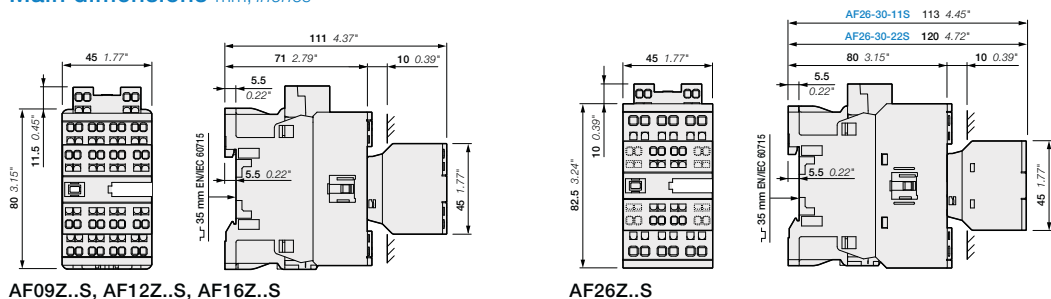

AF09Z..S, AF12Z..S, AF16Z..S

AF26Z..S

1SBC101711S0201 - Rev. A

AF09..S ... AF26..S 3-pole contactors - with spring terminals

Main accessories

Contactor and main accessories (other accessories available)

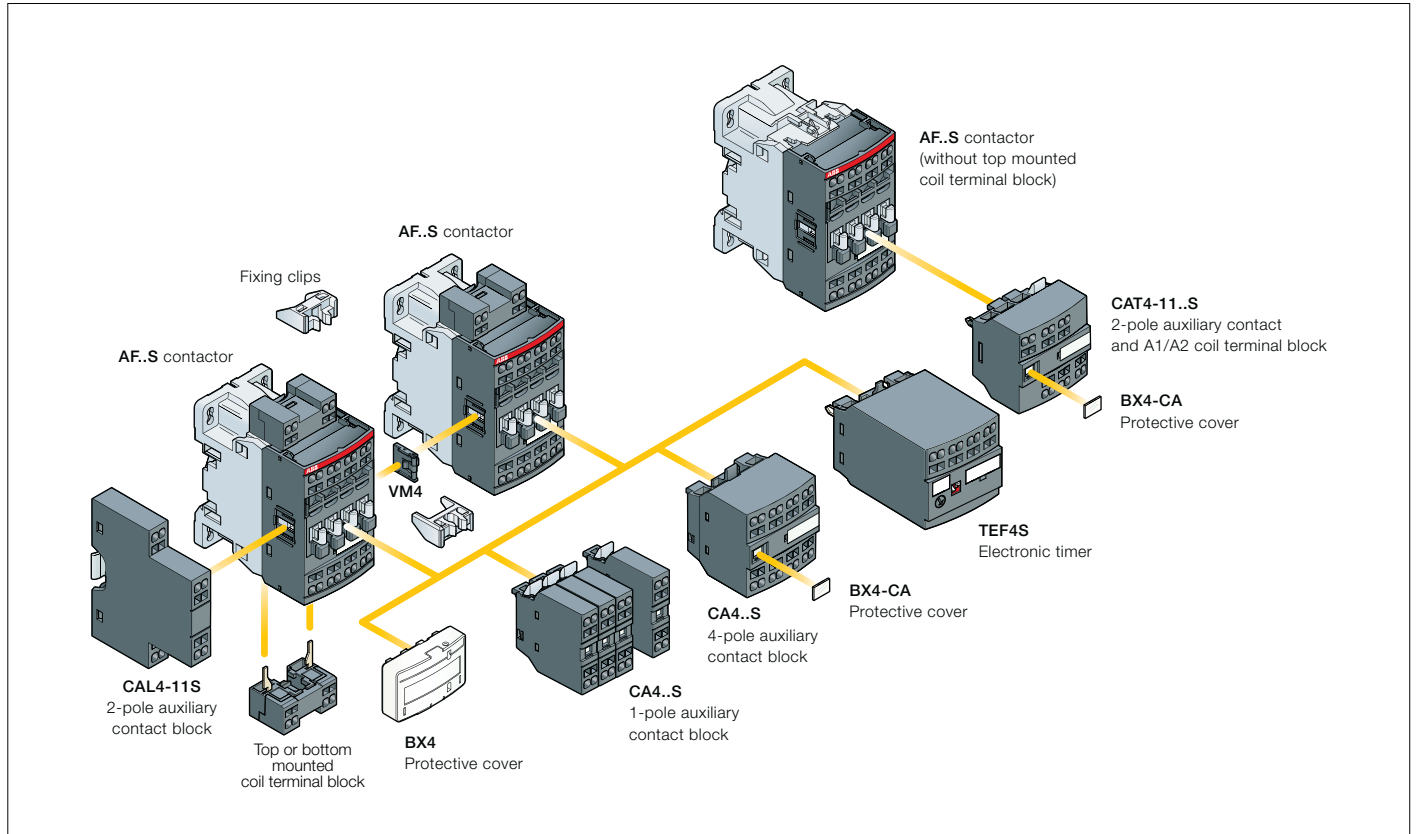

Main accessory fitting details

Many configurations of accessories are possible depending on whether these are front-mounted or side-mounted.

Contactor types	Main poles	Built-in auxiliary contacts	Front-mounted accessories				Side-mounted accessories						
			Auxiliary contact blocks			Electronic timer	Mechanical interlock unit (between 2 contactors)	Auxiliary contact blocks					
			1-pole CA4..S	2-pole CAT4-11..S	4-pole CA4..S	TEF4S	VM4	Left side 2-pole CAL4-11S	Right side				
Max. N.C. built-in and add-on N.C. auxiliary contacts: 4 N.C. max. on positions 1, 2, 3, 4 and 3 N.C. max. on positions 1 ±30°, 5													
AF09..S ... AF16..S	3	0	0	1	4 max. 2 max. 3 max.	or 1	or 1	or 1	-	+ 1	-	+ 1	or 1
AF09..S ... AF16..S	3	0	1	0	4 max.	or 1	or 1	or 1	-	+ 1	-	+ 1	-
AF26..S	3	0	0	0	2 max.	or 1	-	or 1	-	+ 1	-	+ 1	or 1
AF26..S	3	0	1	1	-	-	-	-	+ 1	-	1	-	+ 1
AF09..S ... AF26..S	3	0	2	2	-	-	-	-	-	-	1	-	-

AF09..S ... AF26..S 3-pole contactors - with spring terminals

Main accessories



CA4-10S



CA4-22MS



CAL4-11S



CAT4-11ES



TEF4S-OFF



VM4



LDC4S





BX4



BX4-CA

Ordering details (1)

For contactors	Auxiliary contacts	Type	Order code	Pkg qty	Weight (1 pce)
	 				kg

Front-mounted instantaneous auxiliary contact blocks

AF09..S ... AF26..S	1 0	CA4-10S	1SBN010119R1010	1	0.016
	1 0	CA4-10S-T	1SBN010119T1010	10	0.016
	0 1	CA4-01S	1SBN010119R1001	1	0.016
	0 1	CA4-01S-T	1SBN010119T1001	10	0.016
AF09 ... AF16...-30-10S	2 2	CA4-22MS	1SBN010145R1122	1	0.060
	3 1	CA4-31MS	1SBN010145R1131	1	0.060
AF26..S	2 2	CA4-22ES	1SBN010145R1022	1	0.060
	3 1	CA4-31ES	1SBN010145R1031	1	0.060
	4 0	CA4-40ES	1SBN010145R1040	1	0.060

Side-mounted instantaneous auxiliary contact blocks



AF09..S ... AF26..S	1 1	CAL4-11S	1SBN010130R1011	1	0.045
---------------------	-----	----------	-----------------	---	-------

Front-mounted instantaneous auxiliary contact and A1/A2 coil terminal blocks

AF09 ... AF16...-30-10S	1 1	CAT4-11MS	1SBN010153R1111	1	0.045
AF26..S	1 1	CAT4-11ES	1SBN010153R1011	1	0.045
AF09 ... AF16...-30-01S	1 1	CAT4-11US	1SBN010153R1311	1	0.045

Note: CAT4 not fittable on AF..Z contactors with DC control voltage 12...20 V DC.

Ordering details (1)

For contactors	Time delay range selected by switch	Delay type	Rated control circuit voltage U _c	Auxiliary contacts	Type	Order code	Pkg qty	Weight (1 pce)
			V 50/60 Hz or DC	 				kg

Front-mounted electronic timer

AF09..S ... AF26..S	0.1...1 s 1...10 s 10...100 s	ON-delay	24...240	1 1	TEF4S-ON	1SBN020113R1000	1	0.065
		OFF-delay	24...240	1 1	TEF4S-OFF	1SBN020115R1000	1	0.065

Ordering details (1)

For contactors	Type	Order code	Pkg qty	Weight (1 pce)
				kg

Mechanical interlock unit

AF09..S ... AF26..S	VM4	1SBN030105T1000	10	0.005
---------------------	-----	-----------------	----	-------

Note: VM4 includes 2 fixing clips (BB4) to maintain together both contactors.

Additional coil terminal block

AF09..S ... AF26..S	LDC4S	1SBN070157T1000	10	0.010
---------------------	-------	-----------------	----	-------

Protective covers

All 1-stack contactors	BX4	1SBN110108T1000	10	0.006
For 4-pole CA4..S and 2-pole CAT4..S auxiliary contact blocks	BX4-CA	1SBN110109W1000	50	0.001

(1) See "Main accessory fitting details" table.

Note: Following accessories can be used on 3-pole contactors AF09 ... AF96 with screw terminals :

- 1 or 4-pole CA4...S auxiliary contact blocks
- 2-pole CAL4-11S auxiliary contact blocks
- TEF4S electronic timer
- LDC4S coil terminal block.

AF09..S ... AF26..S 3-pole contactors - with spring terminals

Technical data

Main pole - Utilization characteristics according to IEC

Contactor types	AC / DC operated	AF09..S	AF12..S	AF16..S	AF26..S
Standards		IEC 60947-1 / 60947-4-1 and EN 60947-1 / 60947-4-1			
Rated operational voltage U_e max.		690 V			
Rated frequency (without derating)		50/60 Hz			
Conventional free-air thermal current I_{th}					
acc. to IEC 60947-4-1, open contactors, $\theta \leq 40^\circ\text{C}$		24 A	24 A	24 A	35 A
With conductor cross-sectional area		2.5 mm ²	2.5 mm ²	2.5 mm ²	4 mm ²
AC-1 Utilization category					
For air temperature close to contactor					
I_e / Rated operational current AC-1	$\theta \leq 40^\circ\text{C}$	22 A	24 A	24 A	35 A
U _e max. \leq 690 V, 50/60 Hz	$\theta \leq 60^\circ\text{C}$	18 A	20 A	20 A	30 A
	$\theta \leq 70^\circ\text{C}$	15 A	16 A	16 A	25 A
With conductor cross-sectional area		2.5 mm ²	2.5 mm ²	2.5 mm ²	4 mm ²
AC-3 Utilization category					
For air temperature close to contactor $\theta \leq 60^\circ\text{C}$					
I_e / Max. rated operational current AC-3 (1)					
	220-230-240 V	9 A	12 A	18 A	26 A
	380-400 V	9 A	12 A	18 A	26 A
	415 V	9 A	12 A	18 A	26 A
	440 V	9 A	12 A	18 A	26 A
	500 V	9.5 A	12.5 A	15 A	23 A
	690 V	7 A	9 A	10.5 A	17 A
Rated operational power AC-3 (1)					
	220-230-240 V	2.2 kW	3 kW	4 kW	6.5 kW
	380-400 V	4 kW	5.5 kW	7.5 kW	11 kW
	415 V	4 kW	5.5 kW	9 kW	11 kW
	440 V	4 kW	5.5 kW	9 kW	15 kW
	500 V	5.5 kW	7.5 kW	9 kW	15 kW
	690 V	5.5 kW	7.5 kW	9 kW	15 kW
Rated making capacity AC-3		10 x I _e AC-3 acc. to IEC 60947-4-1			
Rated breaking capacity AC-3		8 x I _e AC-3 acc. to IEC 60947-4-1			
AC-8a Utilization category					
(without thermal overload relay - U _e 400 V 50/60 Hz - $\theta \leq 40^\circ\text{C}$)					
I_e / Rated operational current AC-8a		12 A	16 A	22 A	30 A
Rated operational power AC-8a		5.5 kW	7.5 kW	11 kW	15 kW
Short-circuit protection device for contactors					
without thermal overload relay - Motor protection excluded (2)					
U _e \leq 500 V AC - gG type fuse		25 A	25 A	25 A	40 A
Rated short-time withstand current I_{cw}					
at 40 °C ambient temperature,	1 s	300 A	300 A	300 A	700 A
in free air from a cold state	10 s	150 A	150 A	150 A	350 A
	30 s	80 A	80 A	80 A	225 A
	1 min	60 A	60 A	60 A	150 A
	15 min	24 A	24 A	24 A	35 A
Maximum breaking capacity					
cos ϕ = 0.45	at 440 V	250 A	250 A	250 A	500 A
	at 690 V	106 A	106 A	106 A	200 A
Power dissipation per pole					
	I_e / AC-1	0.9 W	1.1 W	1.1 W	1.8 W
	I_e / AC-3	0.15 W	0.3 W	0.6 W	1 W
Max. electrical switching frequency					
	AC-1	600 cycles/h			
	AC-3	1200 cycles/h			
	AC-2, AC-4	300 cycles/h			
					150 cycles/h

(1) For the corresponding kW/A or hp/A values of 1500 r.p.m, 50 Hz or 1800 r.p.m, 60 Hz, 3-phase motors, see "Motor rated operational powers and currents".

(2) For the protection of motor starters against short circuits, see "Coordination with short-circuit protection devices".



3-phase motors



1500 r.p.m. 50 Hz
1800 r.p.m. 60 Hz
3-phase motors

AF09..S ... AF26..S 3-pole contactors - with spring terminals

Technical data

Main pole - Utilization characteristics according to UL / NEMA / CSA

Contactor types	AC / DC operated	AF09..S	AF12..S	AF16..S	AF26..S
Standards		UL 508, CSA C22.2 N°14			-
Max. operational voltage		690 V			
NEMA size		00	0	-	-
NEMA continuous amp rating	Thermal current	9 A	18 A	-	-
NEMA maximum horse power ratings 1-phase, 60 Hz	115 V AC	1/3 hp	1 hp	-	-
	230 V AC	1 hp	2 hp	-	-
NEMA maximum horse power ratings 3-phase, 60 Hz	200 V AC	1-1/2 hp	3 hp	-	-
	230 V AC	1-1/2 hp	3 hp	-	-
	460 V AC	2 hp	5 hp	-	-
	575 V AC	2 hp	5 hp	-	-
UL / CSA General use rating					
600 V AC		20 A	20 A	20 A	-
With conductor cross-sectional area		AWG 12	AWG 12	AWG 12	-
UL / CSA maximum 1-phase motor rating					
Full load current	120 V AC	13.8 A	16 A	16 A	-
	240 V AC	10 A	12 A	12 A	-
Horse power rating	120 V AC	3/4 hp	1 hp	1 hp	-
	240 V AC	1 1/2 hp	2 hp	2 hp	-
UL / CSA maximum 3-phase motor rating					
Full load current (1)	200-208 V AC	7.8 A	11 A	11 A	-
	220-240 V AC	6.8 A	9.6 A	15.2 A	-
	440-480 V AC	7.6 A	11 A	14 A	-
	550-600 V AC	9 A	11 A	11 A	-
Horse power rating (1)	200-208 V AC	2 hp	3 hp	3 hp	-
	220-240 V AC	2 hp	3 hp	5 hp	-
	440-480 V AC	5 hp	7.5 hp	10 hp	-
	550-600 V AC	7.5 hp	10 hp	10 hp	-
Short-circuit protection device for contactors					
without thermal overload relay - Motor protection excluded					
Fuse rating		30	30	60	-
Fuse type, 600 V		J	J	J	-
Max. electrical switching frequency					
For general use		600 cycles/h	600 cycles/h	600 cycles/h	-
For motor use		1200 cycles/h	1200 cycles/h	1200 cycles/h	-

(1) For the corresponding kW/A or hp/A values of 1500 r.p.m, 50 Hz or 1800 r.p.m, 60 Hz, 3-phase motors, see "Motor rated operational powers and currents".

General technical data

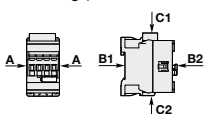
Contactor types	AC / DC operated	AF09..S	AF12..S	AF16..S	AF26..S
Rated insulation voltage Ui		690 V			
acc. to IEC 60947-4-1		600 V			
acc. to UL / CSA		-			
Rated impulse withstand voltage Uimp.		6 kV			
Electromagnetic compatibility		Devices complying with IEC 60947-1 / EN 60947-1 - Environment A and B (2)			
Ambient air temperature close to contactor					
Operation without thermal overload relay		-40...+70 °C			
Storage		-60...+80 °C			
Climatic withstand		Category B according to IEC 60947-1 Annex Q			
Maximum operating altitude (without derating)		3000 m			
Mechanical durability					
Number of operating cycles		10 millions operating cycles			
Max. switching frequency		3600 cycles/h			
Shock withstand					
acc. to IEC 60068-2-27 and EN 60068-2-27					
Mounting position 1	Shock direction	1/2 sinusoidal shock for 11 ms: no change in contact position, closed or open position			
	A	30 g			
	B1	25 g closed position / 5 g open position			
	B2	15 g			
	C1	25 g			
	C2	25 g			
Vibration withstand		5...300 Hz			
acc. to IEC 60068-2-6		4 g closed position / 2 g open position			

(2) Environment B: all AF09 ... AF38 contactors produced since week 08-2013. AF09 ... AF38-...-12 (48...130 V 50/60 Hz-DC) compliant to environment A only. For environment B: select AF09 ... AF38-...-22.

AF09..S ... AF26..S 3-pole contactors - with spring terminals

Technical data

Magnet system characteristics

Contactor types	AC / DC operated	AF09..S	AF12..S	AF16..S	AF26..S
Coil operating limits acc. to IEC 60947-4-1	AC supply	At $\theta \leq 60^\circ\text{C}$ $0.85 \times U_c \text{ min...} 1.1 \times U_c \text{ max.}$ At $\theta \leq 70^\circ\text{C}$ $0.85 \times U_c \text{ min...} U_c \text{ max.}$			
	DC supply	At $\theta \leq 60^\circ\text{C}$ $0.85 \times U_c \text{ min...} 1.1 \times U_c \text{ max.}$ At $\theta \leq 70^\circ\text{C}$ (AF) $0.85 \times U_c \text{ min...} U_c \text{ max.}$ - (AF..Z) $0.85 \times U_c \text{ min...} 1.1 \times U_c \text{ max.}$			
AC control voltage	Rated control circuit voltage U_c	24...500 V AC			
50/60 Hz	Coil consumption	Average pull-in value	(AF) 50 VA - (AF..Z) 16 VA		
		Average holding value	(AF) 2.2 VA / 2 W - (AF..Z) 1.7 VA / 1.5 W		
DC control voltage	Rated control circuit voltage U_c	12...500 V DC			
	Coil consumption	Average pull-in value	(AF) 50 W - (AF..Z) 12...16 W		
		Average holding value	(AF) 2 W - (AF..Z) 1.7 W		
PLC-output control		(AF..Z) $\geq 500 \text{ mA}$ 24 V DC			
Drop-out voltage		$\leq 60\%$ of $U_c \text{ min.}$			
Voltage sag immunity acc. to SEMI F47-0706		(AF..Z) conditions of use on request			
Dips withstand $-20^\circ\text{C} \leq \theta \leq +60^\circ\text{C}$		(AF..Z) 22 ms average for $U_c \geq 24 \text{ V}$ 50/60 Hz or $U_c \geq 20 \text{ V}$ DC			
Operating time	Between coil energization and:	N.O. contact closing	40...95 ms		
		N.C. contact opening	38...90 ms		
	Between coil de-energization and:	N.O. contact opening	11...95 ms		
		N.C. contact closing	13...98 ms		













Mounting characteristics and conditions for use

Contactor types	AC / DC operated	AF09..S	AF12..S	AF16..S	AF26..S
Mounting positions					
Mounting distances		Max. N.C. built-in and add-on N.C. auxiliary contacts: see accessory fitting details for a 3-pole contactor AF09..S ... AF26..S			
Fixing	On rail according to IEC 60715, EN 60715 By screws (not supplied)	The contactors can be assembled side by side 35 x 7.5 mm or 35 x 15 mm 2 x M4 screws placed diagonally			

AF09..S ... AF26..S 3-pole contactors - with spring terminals

Technical data

Connecting characteristics

Contactor types	AC / DC operated	AF09..S	AF12..S	AF16..S	AF26..S
Main terminals					
Connection capacity (min. ... max.)		Spring terminals			
Main conductors (poles)					
 Rigid	Solid ($\leq 4 \text{ mm}^2$)	1 x	1...2.5 mm ²		1.5...4 mm ²
 Flexible with non insulated ferrule		2 x	1...2.5 mm ²		1.5...4 mm ²
 Flexible with insulated ferrule		1 x	0.75...2.5 mm ²		1.5...4 mm ²
 Flexible with insulated ferrule		2 x	0.75...2.5 mm ²		1.5...4 mm ²
 Flexible with insulated ferrule		1 x	0.75...1.5 mm ²		1.5...4 mm ²
 Flexible with insulated ferrule		2 x	0.75...1.5 mm ²		1.5...4 mm ²
Connection capacity acc. to UL/CSA		1 or 2 x	AWG 18...12		-
Stripping length			10 mm		14 mm
Auxiliary conductors (built-in auxiliary terminals + coil terminals)					
 Rigid solid		1 x	1...2.5 mm ²		
 Flexible with non insulated ferrule		2 x	1...2.5 mm ²		
 Flexible with insulated ferrule		1 x	0.75...2.5 mm ²		
 Flexible with insulated ferrule		2 x	0.75...2.5 mm ²		
 Flexible with insulated ferrule		1 x	0.75...1.5 mm ²		
 Flexible with insulated ferrule		2 x	0.75...1.5 mm ²		
Connection capacity acc. to UL/CSA		1 or 2 x	AWG 18...14		-
Stripping length			10 mm		
Degree of protection					
acc. to IEC 60947-1 / EN 60947-1 and IEC 60529 / EN 60529					
Main terminals		IP20			
Coil terminals		IP20			
Built-in auxiliary terminals		IP20			
Screwdriver type		Flat Ø 3.5			

AF09..S ... AF26..S 3-pole contactors - with spring terminals

Technical data

Built-in auxiliary contacts according to IEC

Contactor types	AC / DC operated	AF09..S	AF12..S	AF16..S	AF26..S
Rated operational voltage U_e max.		690 V			
Rated frequency (without derating)		50/60 Hz			
Conventional free air thermal current $I_{th} - \theta \leq 40^\circ\text{C}$		16 A			
le / Rated operational current AC-15					
acc. to IEC 60947-5-1	24-127 V 50/60 Hz	6 A			
	220-240 V 50/60 Hz	4 A			
	400-440 V 50/60 Hz	3 A			
	500 V 50/60 Hz	2 A			
	690 V 50/60 Hz	2 A			
Making capacity AC-15		10 x le AC-15 acc. to IEC 60947-5-1			
Breaking capacity AC-15		10 x le AC-15 acc. to IEC 60947-5-1			
le / Rated operational current DC-13					
acc. to IEC 60947-5-1	24 V DC	6 A / 144 W			
	48 V DC	2.8 A / 134 W			
	72 V DC	1 A / 72 W			
	110 V DC	0.55 A / 60 W			
	125 V DC	0.55 A / 69 W			
	220 V DC	0.27 A / 60 W			
	250 V DC	0.27 A / 68 W			
	400 V DC	0.15 A / 60 W			
	500 V DC	0.13 A / 65 W			
	600 V DC	0.1 A / 60 W			
Short-circuit protection device gG type fuse		10 A			
Rated short-time withstand current I_{cw}	for 1.0 s	100 A			
	for 0.1 s	140 A			
Minimum switching capacity		12 V / 3 mA			
with failure rate acc. to IEC 60947-5-4		10^{-7}			
Non-overlapping time between N.O. and N.C. contacts		≥ 2 ms			
Power dissipation per pole at 6 A		0.1 W			
Max. electrical switching frequency	AC-15	1200 cycles/h			
	DC-13	900 cycles/h			
Mechanically linked contacts		Built-in N.O. or N.C. auxiliary contacts and additional N.O. or N.C. auxiliary contacts (CA4..S, CAL4..S, CAT4..S aux. contact blocks) are mechanically linked contacts.			
(according to annex L of IEC 60947-5-1)					
Mirror contacts		Built-in N.C. auxiliary contacts or additional N.C. auxiliary contacts (CA4..S, CAL4..S, CAT4..S aux. contact blocks) are mirror contacts.			
(according to annex F of IEC 60947-4-1)					

Built-in auxiliary contacts according to UL / CSA

Contactor types	AC / DC operated	AF09..S	AF12..S	AF16..S	AF26..S
Max. operational voltage		600 V AC, 600 V DC			-
Pilot duty		A600, Q600			-
AC thermal rated current		10 A			-
AC maximum volt-ampere making		7200 VA			-
AC maximum volt-ampere breaking		720 VA			-
DC thermal rated current		2.5 A			-
DC maximum volt-ampere making-breaking		69 VA			-

AF09..S ... AF26..S 3-pole contactors - with spring terminals

Contactors electrical durability and utilization categories

General

Utilization categories determine the current making and breaking conditions relating to the characteristics of the loads to be controlled by the contactors. International standard IEC 60947-4-1 and European standard EN 60947-4-1 are the standards to be referred to.

If I_c is the current to be broken by the contactor and I_e the rated operational current normally drawn by the load, then:

- Categories AC-1 and AC-3: $I_c = I_e$
- Category AC-2: $I_c = 2.5 \times I_e$
- Category AC-4: $I_c = 6 \times I_e$

Generally speaking $I_c = m \times I_e$ where m is a multiple of the load operational current.

On next pages, the curves corresponding to categories AC-1, AC-3, AC-2 and AC-4 represent the electrical durability variation of standard contactors in relation to the breaking current I_c .

Electrical durability is expressed in millions of operating cycles.

Curve utilization mode

Electrical durability forecast and contactor selection for categories AC-1, AC-2, AC-3 or AC-4

- Note the characteristics of the load to be controlled:
 - Operational voltage U_e
 - Current normally drawn I_e ($U_e / I_e / kW$ relation for motors, see "Motor rated operational powers and currents").
 - Utilization category AC-1, AC-2, AC-3 or AC-4
 - Breaking current $I_c = I_e$ for AC-1 and for AC-3 ; $I_c = 2.5 \times I_e$ for AC-2 ; $I_c = 6 \times I_e$ for AC-4
- Define the number of operating cycles N required.
- On the diagram corresponding to the operational category, select the contactor with the curve immediately above the intersection point ($I_c ; N$).

Electrical durability forecast and contactor selection for mixed duty motor control: AC-3 ($I_c = I_e$) type switching off while "motor running" and, occasionally, AC-4 ($I_c = 6 \times I_e$) type switching off while "motor accelerating"

- Note the characteristics of the motor to be controlled:
 - Operational voltage U_e
 - Current normally drawn while "motor running" I_e ($U_e / I_e / kW$ relation for motors, see "Motor rated operational powers and currents")
 - Breaking current for AC-3 $I_c = I_e$
 - Breaking current for AC-4 while "motor accelerating" $I_c = 6 \times I_e$
 - Percentage of AC-4 operating cycles K (on the basis of the total number of operating cycles)
- Define the total number of operating cycles N required.
- Note the smallest contactor rating compatible for AC-3 (U_e / I_e) on Main pole utilization characteristic table (see "Technical data").
- For the selected contactor make a note of the following in relation to the voltage using diagram AC-3 in next pages:
 - The number of operating cycles A for $I_c = I_e$ (AC-3)
 - The number of operating cycles B for $I_c = 6 \times I_e$ (AC-4)
- Calculate the estimated number of cycles N' (N' is always below A)

$$N' = \frac{A}{1 + 0.01 K (A/B - 1)}$$

- If N' is too low in relation to the target N , calculate the estimated number of cycles for a higher contactor rating.

Case of uninterrupted duty

For uninterrupted duty, some verifications of preventing maintenance are necessary to check the functionality of the concerned product (consult us).

The combined effect of environmental conditions and the proper temperature of the product may require some disposals. As a matter of fact, for this duty, the use duration prevails over the number of operating cycles.

AF09..S ... AF26..S 3-pole contactors - with spring terminals

Electrical durability

Electrical durability for AC-1 utilization category - $U_e \leq 690$ V. Ambient temperature ≤ 60 °C

Switching non-inductive or slightly inductive loads. The breaking current I_c for AC-1 is equal to the rated operational current of the load.

Maximum electrical switching frequency: see "Technical data".

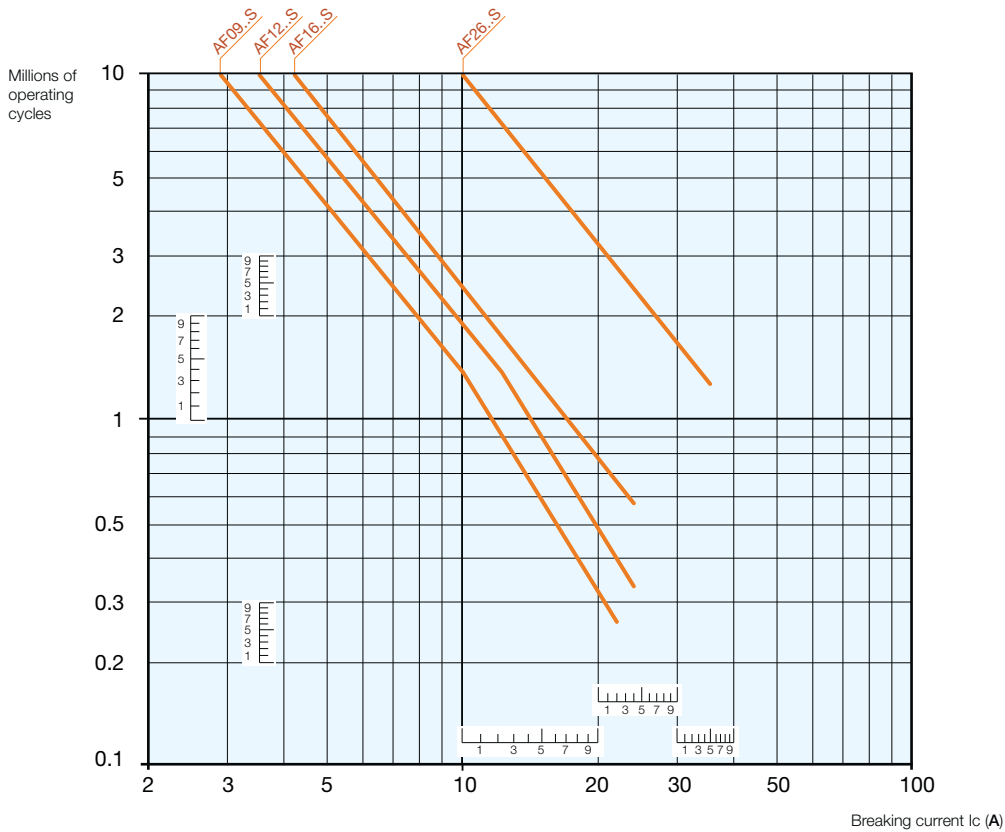

AF09..S ... AF26..S 3-pole contactors AC-1 electrical durability

AF09..S ... AF26..S 3-pole contactors - with spring terminals

Electrical durability

Electrical durability for AC-3 utilization category

Switching cage motors: starting and switching off running motors. The breaking current I_c for AC-3 is equal to the rated operational current I_e (I_e = motor full load current). Maximum electrical switching frequency: see "Technical data".

AC-3 - $U_e \leq 440$ V - Ambient temperature ≤ 60 °C

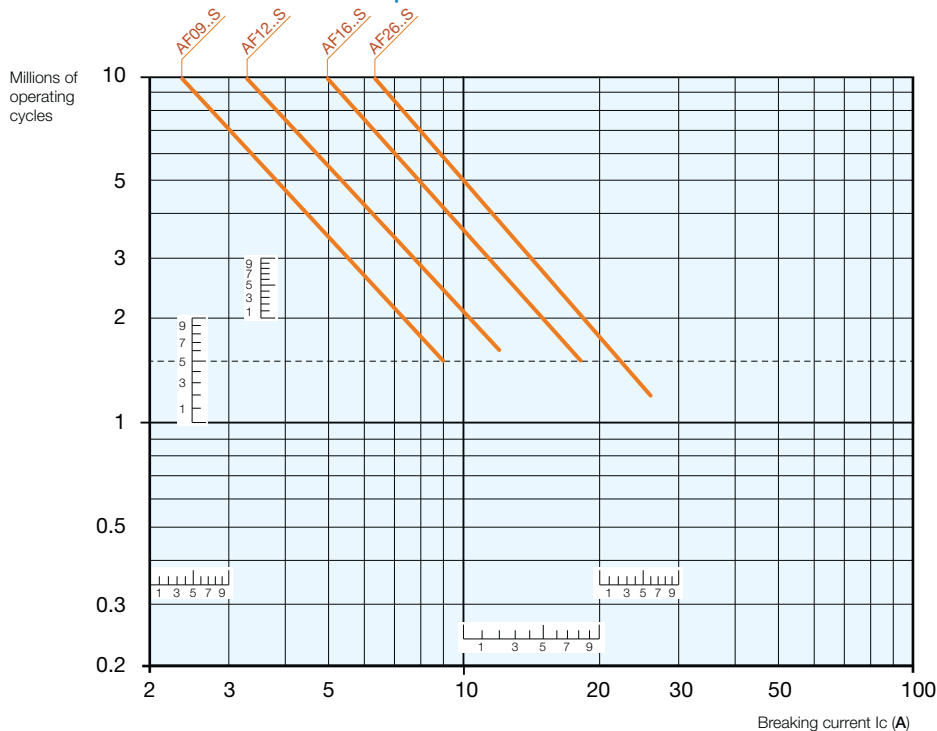

AF09..S ... AF26..S 3-pole contactors AC-3 electrical durability for $U_e \leq 440$ V

AC-3 - 440 V < $U_e \leq 690$ V - Ambient temperature ≤ 60 °C

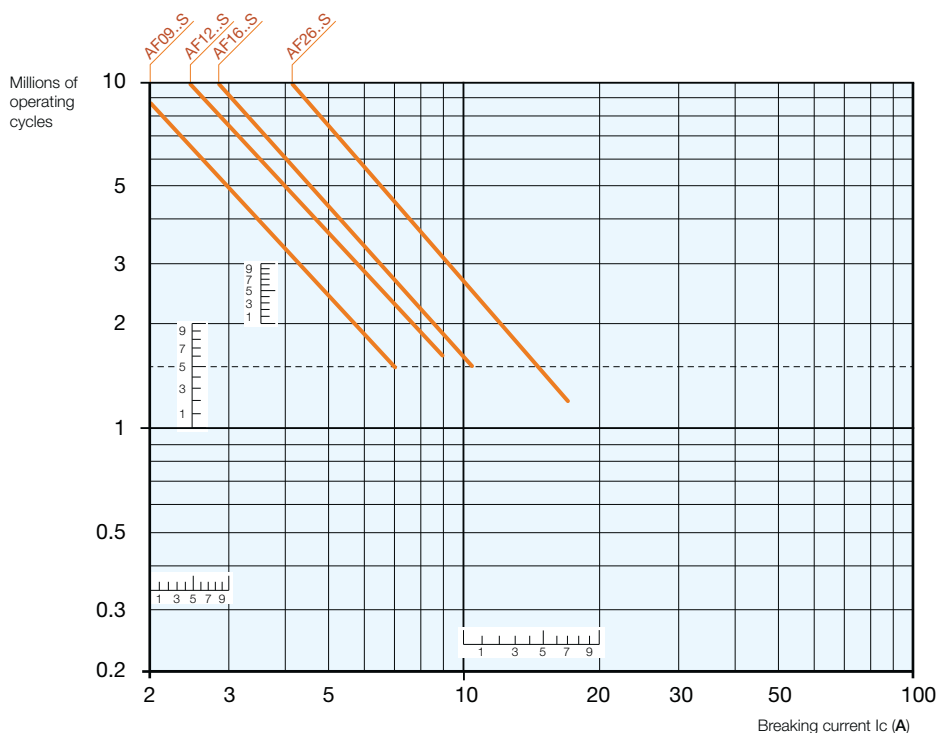

AF09..S ... AF26..S 3-pole contactors AC-3 electrical durability for 440 V < $U_e \leq 690$ V

AF09..S ... AF26..S 3-pole contactors - with spring terminals

Electrical durability

Electrical durability for AC-2 or AC-4 utilization category

Switching cage motors: starting, reverse operation and step-by-step operation. The breaking current I_c is equal to $2.5 \times I_e$ for AC-2 and $6 \times I_e$ for AC-4, keeping in mind that I_e is the motor rated operational current (I_e = motor full-load current).
Maximum electrical switching frequency: see "Technical data".

AC-2 or AC-4 - $U_e \leq 440 \text{ V}$ - Ambient temperature $\leq 60 \text{ }^\circ\text{C}$

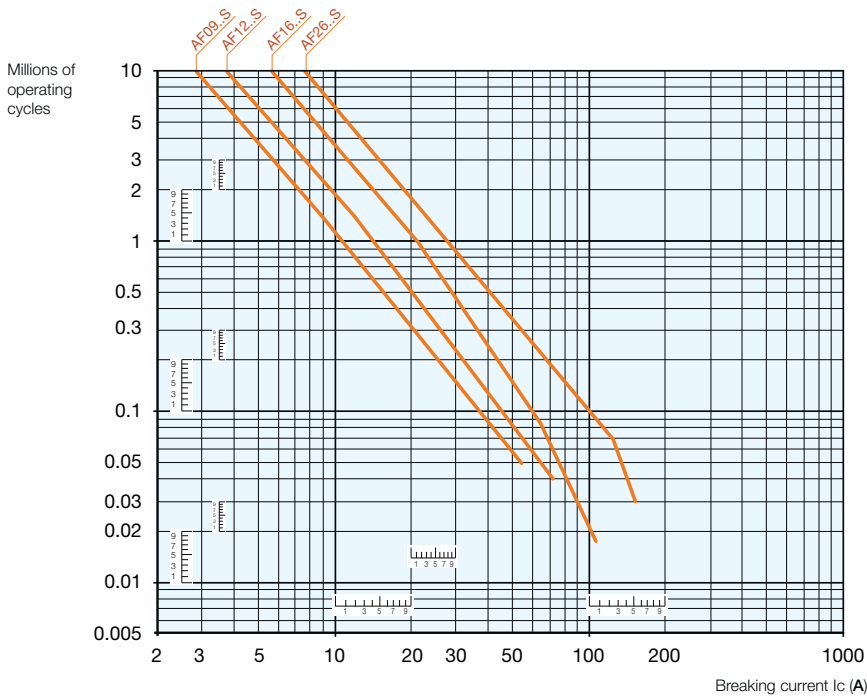

AF09..S ... AF26..S 3-pole contactors AC-2 or AC-4 electrical durability for $440 \text{ V} < U_e \leq 690 \text{ V}$

AC-2 or AC-4 - $440 \text{ V} < U_e \leq 690 \text{ V}$ - Ambient temperature $\leq 60 \text{ }^\circ\text{C}$

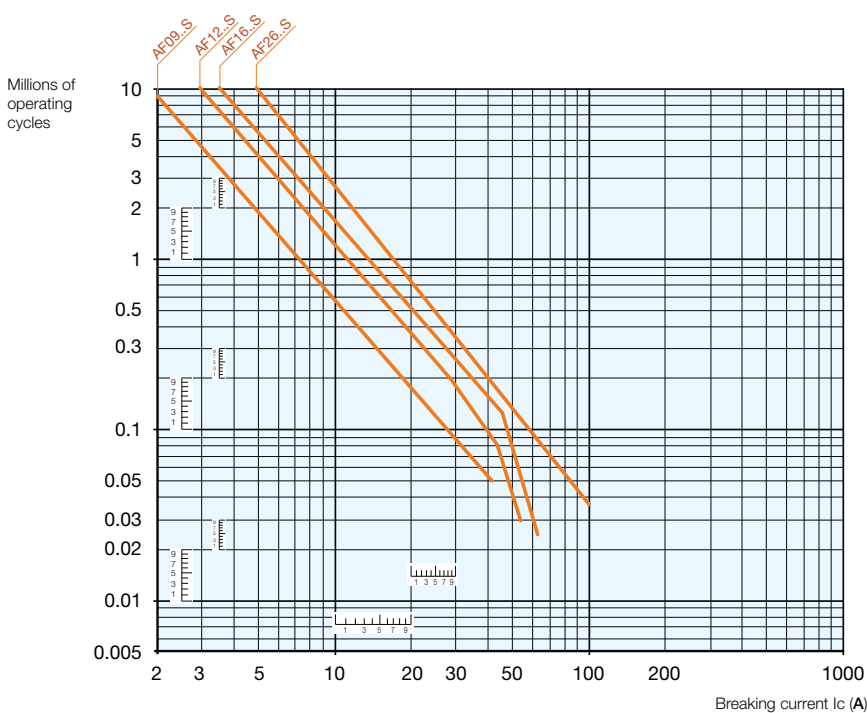

AF09..S ... AF26..S 3-pole contactors AC-2 or AC-4 electrical durability for $440 \text{ V} < U_e \leq 690 \text{ V}$

AF09..S ... AF26..S 3-pole contactors - with spring terminals

Terminal marking and positioning

AF09..S ... AF26..S contactors - AC / DC operated

Standard devices without addition of auxiliary contacts

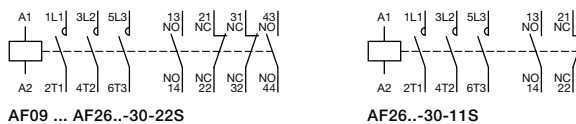
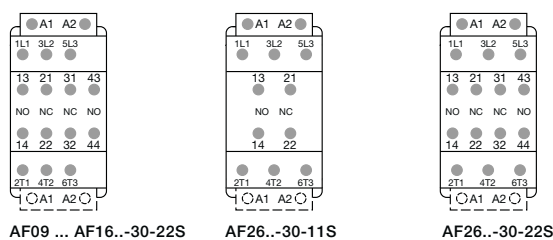
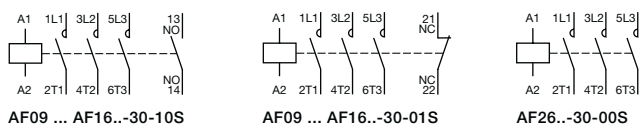
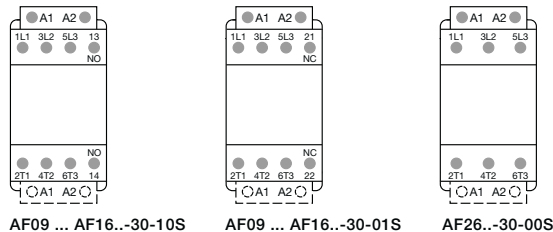

Other possible contact combinations with auxiliary contacts added by the user

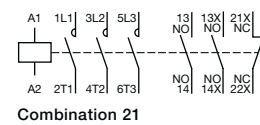
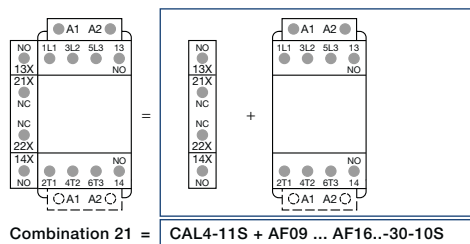
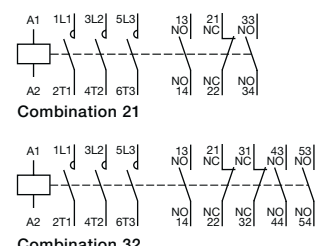
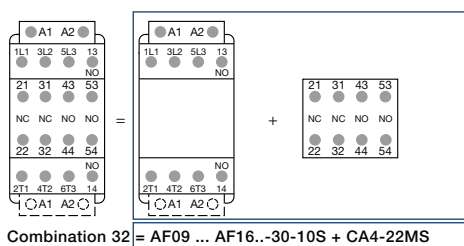
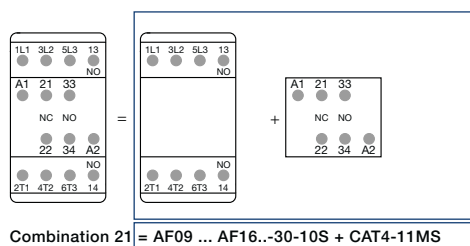
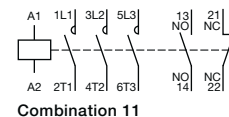
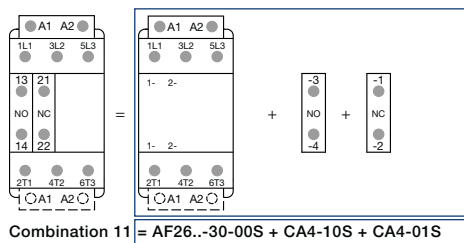
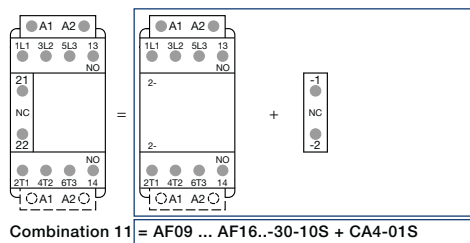

Note: Only AF.Z contactor with DC control voltage 12...20 V DC need to respect the connection polarities indicated close to the coil terminals: A1+ for the positive pole and A2- for the negative pole.

AF09..S ... AF16..S 3-pole contactors - with spring terminals

Main dimensions mm, inches

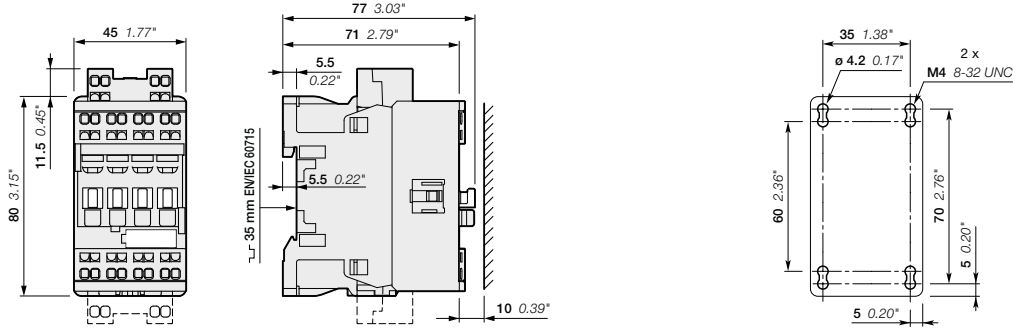

AF09..S, AF12..S, AF16..S

6

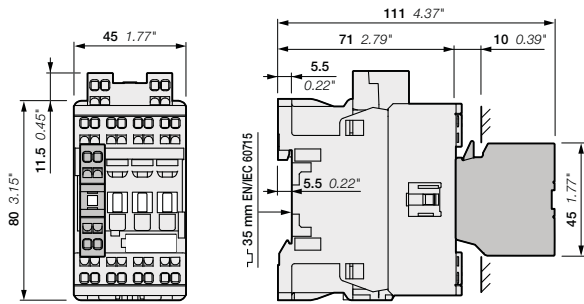

AF09..S, AF12..S, AF16..S
+ CA4..S 1-pole auxiliary contact block

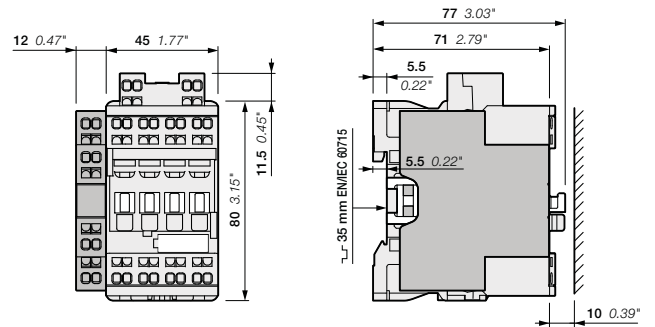

AF09..S, AF12..S, AF16..S
+ CAL4-11S 2-pole auxiliary contact block

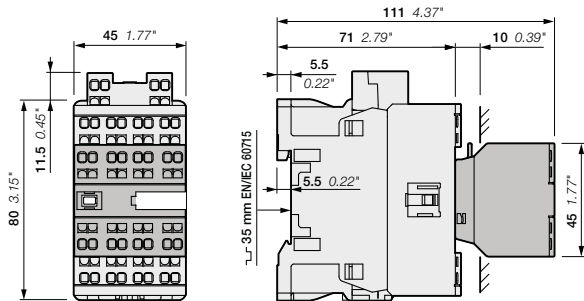

AF09..S, AF12..S, AF16..S
+ CA4..S 4-pole auxiliary contact block

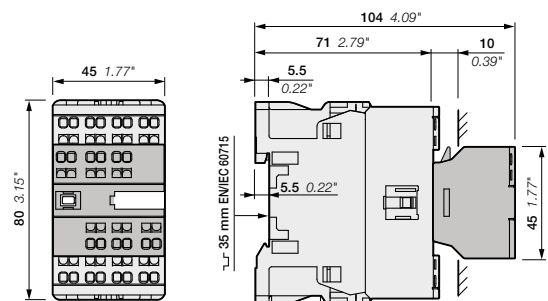

AF09..S, AF12..S, AF16..S
+ CAT4..S 2-pole auxiliary contact and coil terminal block

Note: contactor lateral distance to grounded component 2 mm 0.08" min.

AF26..S 3-pole contactors - with spring terminals

Main dimensions mm, inches

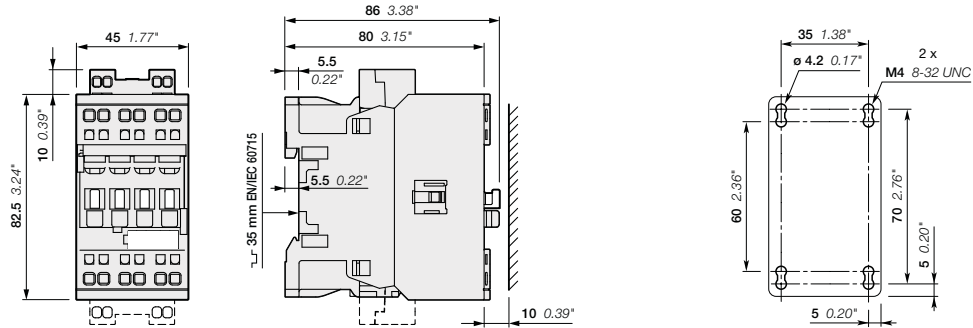

AF26..S

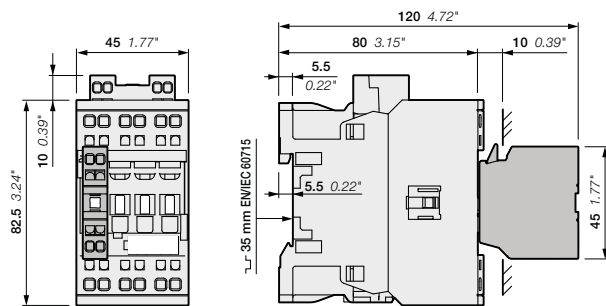

AF26..S
+ CA4..S 1-pole auxiliary contact block

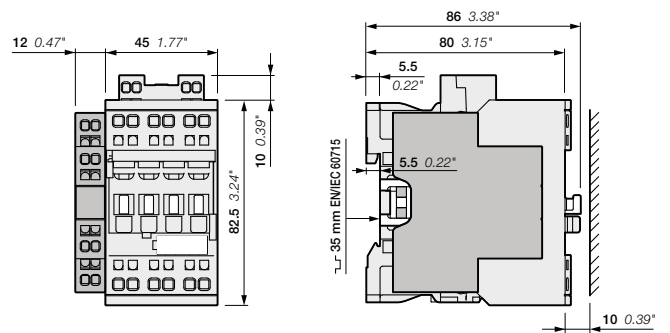

AF26..S
+ CAL4-11S 2-pole auxiliary contact block

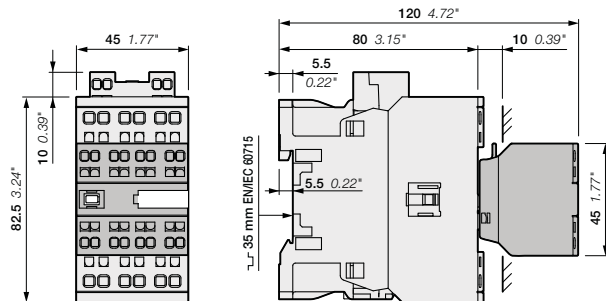

AF26..S
+ CA4..S 4-pole auxiliary contact block

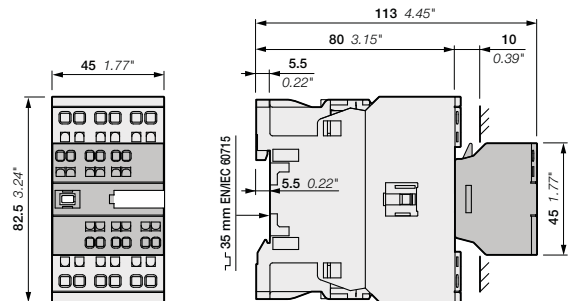

AF26..S
+ CAT4..S 2-pole auxiliary contact and coil terminal block

Note: contactor lateral distance to grounded component 2 mm 0.08" min.

AF09..S ... AF26..S 3-pole contactors - with spring terminals

Main dimensions mm, inches

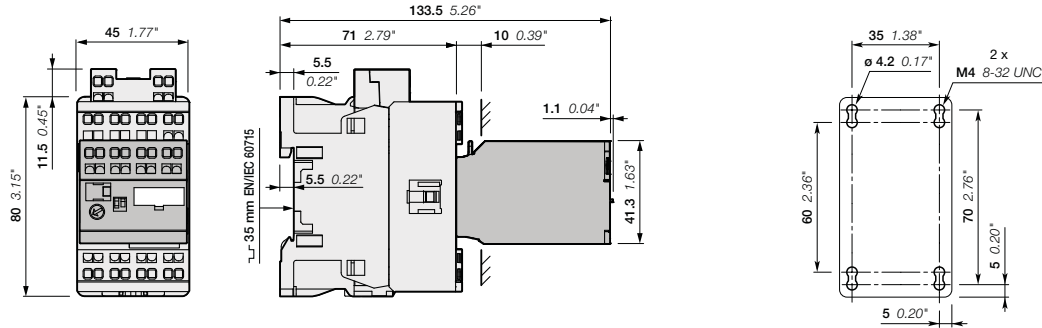

AF09..S, AF12..S, AF16..S
+ TEF4S

6

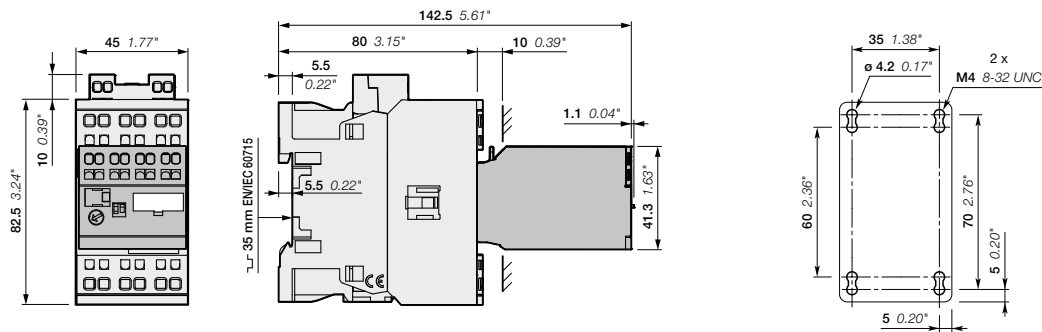

AF26..S
+ TEF4S

Note: contactor lateral distance to grounded component 2 mm 0.08" min.

AF09..S ... AF26..S 2-stack 3-pole contactors - with spring terminal

Main dimensions mm, inches

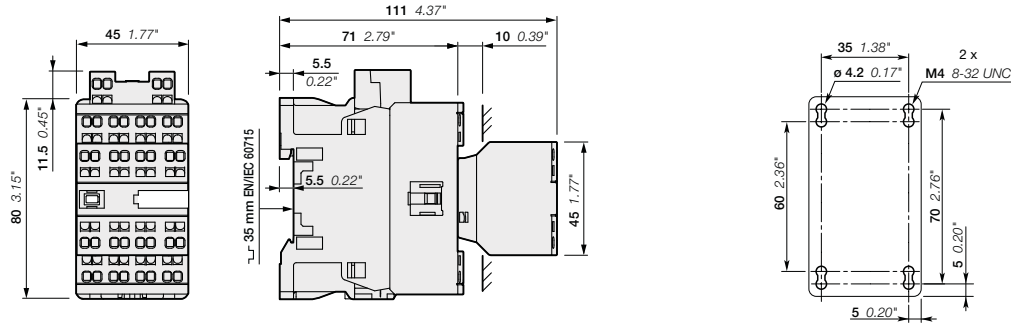

AF09, AF12, AF16..-30-22S

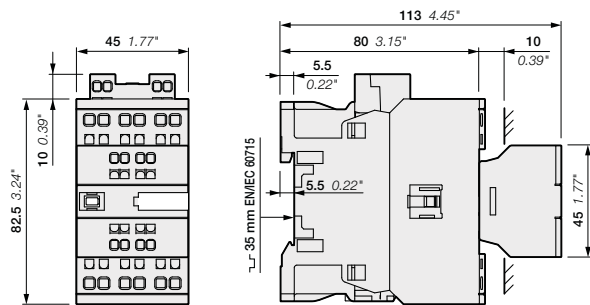

AF26..-30-11S

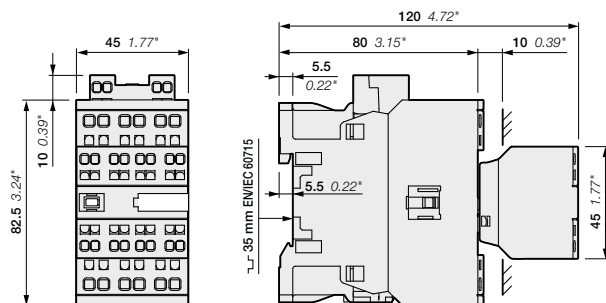

AF26..-30-22S

Note: contactor lateral distance to grounded component 2 mm 0.08 inches min.

Contactor relays - with spring terminals

Main accessories

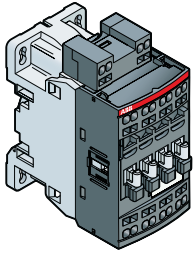

NF22ES, NF31ES and NF40ES
4-pole contactor relays

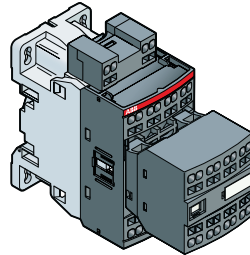

NF44ES, NF53ES, NF62ES, NF71ES and NF80ES
8-pole contactor relays

6

Main accessories for contactor relays

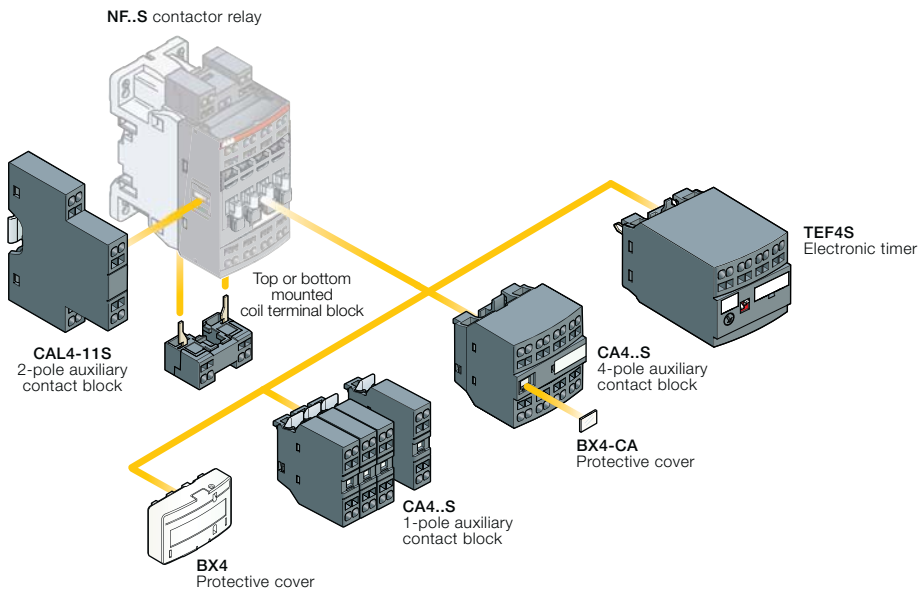

Contactors relays - with spring terminals



Spring terminals



	AC / DC Control voltage	NF22ES	NF31ES	NF40ES
		2N.O. + 2N.C.	3N.O. + 1N.C.	4N.O.



	AC / DC Control supply	NF44ES	NF53ES	NF62ES	NF71ES	NF80ES
		4N.O. + 4N.C.	5N.O. + 3N.C.	6N.O. + 2N.C.	7N.O. + 1N.C.	8N.O.

Control circuit switching

IEC	AC-15	Rated operational current	240 V	4 A
			400 V	3 A
			690 V	2 A
UL/CSA	Pilot Duty	24 V	6 A / 144 W	
		250 V	0.27 A / 68 W	

Main accessories

Auxiliary contact blocks	Front mounting		1-pole CA4-10S or CA4-01S 4-pole CA4..S
	Side mounting		2-pole CAL4-11S
Additional coil terminal block			LDC4S
Protective covers			BX4 For all 1-stack contactor relays BX4-CA For 4-pole CA4..S auxiliary contact blocks

NF..S 4-pole contactor relays - with spring terminals

AC / DC operated



NF22ES

1SBG10109F0014

Description

NF..S contactor relays are used for switching auxiliary and control circuits.

These contactor relays are of the block type design with:

- 4 poles. Contactor relays have mechanically linked auxiliary contact elements (side-marked symbol)
- control circuit: AC or DC operated with electronic coil interface accepting a wide control voltage range (e.g. 100...250 V AC and DC)
- can manage large control voltage variations
- only 4 control voltage ranges covering 24...500 V 50/60 Hz and 20...500 V DC
- reduced panel energy consumption
- very distinct closing and opening.
- built-in surge suppression
- add-on auxiliary contact blocks for front or side mounting and a wide range of accessories.

Ordering details

Number of contacts	Rated control circuit voltage Uc min. ... Uc max.		Type	Order code	Weight Pkg (1 pce) kg	
	V 50/60 Hz	V DC				
	24...60	-	(1)	NF22ES-41	1SBH137004R4122	0.270
	48...130	48...130		NF22ES-12	1SBH137004R1222	0.270
	100...250	100...250		NF22ES-13	1SBH137004R1322	0.270
	250...500	250...500		NF22ES-14	1SBH137004R1422	0.310
	24...60	-	(1)	NF31ES-41	1SBH137004R4131	0.270
	48...130	48...130		NF31ES-12	1SBH137004R1231	0.270
	100...250	100...250		NF31ES-13	1SBH137004R1331	0.270
	250...500	250...500		NF31ES-14	1SBH137004R1431	0.310
	24...60	-	(1)	NF40ES-41	1SBH137004R4140	0.270
	48...130	48...130		NF40ES-12	1SBH137004R1240	0.270
	100...250	100...250		NF40ES-13	1SBH137004R1340	0.270
	250...500	250...500		NF40ES-14	1SBH137004R1440	0.310

(1) For 24...60 V 50/60 Hz - 20...60 V DC, use NF..ES-11 (see voltage code table).
NF..ES-11 not suitable for direct control by PLC-output.

Main dimensions mm, inches

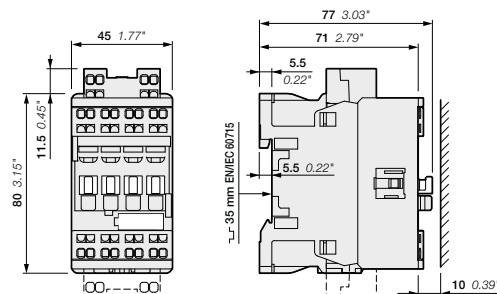

NF22ES, NF31ES, NF40ES

NFZ..S 4-pole contactor relays - with spring terminals AC / DC operated - low consumption



NFZ22ES

Description

NFZ..S contactor relays are used for switching auxiliary and control circuits.

These contactor relays are of the block type design with:

- 4 poles. Contactor relays have mechanically linked auxiliary contact elements (side-marked symbol)
- control circuit: AC or DC operated with electronic coil interface accepting a wide control voltage range (e.g. 100...250 V AC and DC)
 - can manage large control voltage variations
 - only 4 control voltage ranges covering 24...250 V 50/60 Hz and 12...250 V DC
 - allow direct control by PLC-output ≥ 24 V DC 500 mA
 - reduced panel energy consumption
 - very distinct closing and opening
 - can withstand short voltage dips and voltage sags (SEMI F47-0706 conditions of use on request).
- built-in surge suppression
- add-on auxiliary contact blocks for front or side mounting and a wide range of accessories.

Ordering details

Number of contacts	Rated control circuit voltage <i>U_c min. ... U_c max.</i>		Type	Order code	Weight Pkg (1 pce) kg
	V 50/60 Hz	V DC			
	-	12...20	NFZ22ES-20	1SBH136004R2022	0.310
	24...60	20...60	NFZ22ES-21	1SBH136004R2122	0.310
	48...130	48...130	NFZ22ES-22	1SBH136004R2222	0.310
	100...250	100...250	NFZ22ES-23	1SBH136004R2322	0.310
	-	12...20	NFZ31ES-20	1SBH136004R2031	0.310
	24...60	20...60	NFZ31ES-21	1SBH136004R2131	0.310
	48...130	48...130	NFZ31ES-22	1SBH136004R2231	0.310
	100...250	100...250	NFZ31ES-23	1SBH136004R2331	0.310
	-	12...20	NFZ40ES-20	1SBH136004R2040	0.310
	24...60	20...60	NFZ40ES-21	1SBH136004R2140	0.310
	48...130	48...130	NFZ40ES-22	1SBH136004R2240	0.310
	100...250	100...250	NFZ40ES-23	1SBH136004R2340	0.310

Note: Only NFZ..S contactor relays with DC control voltage 12...20 V DC need to respect the connection polarities indicated close to the coil terminals: A1+ for the positive pole and A2- for the negative pole.

Main dimensions mm, inches

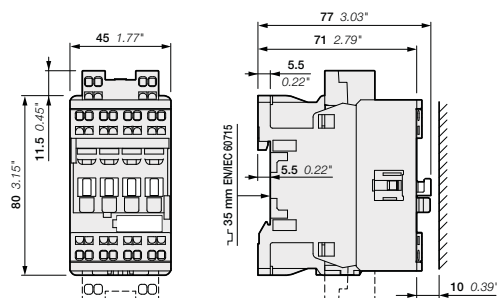

NFZ22ES, NFZ31ES, NFZ40ES

NF..S 8-pole contactor relays - with spring terminals AC / DC operated



NF44ES

Description

NF..S contactor relays are used for switching auxiliary and control circuits.

These contactors relays are of the block type design with:

- 8 poles with a permanently fixed 4-pole auxiliary contact block. Contactor relays have mechanically linked auxiliary contact elements (side-marked symbol)
- control circuit: AC or DC operated with electronic coil interface accepting a wide control voltage range (e.g. 100...250 V AC and DC)
 - can manage large control voltage variations
 - only 4 control voltage ranges covering 24...500 V 50/60 Hz and 20...500 V DC
 - reduced panel energy consumption
 - very distinct closing and opening.
- built-in surge suppression
- add-on auxiliary contact blocks for side mounting and a wide range of accessories.

Ordering details

Number of contacts		Rated control circuit voltage Uc min. ... Uc max.	Type	Order code	Weight Pkg (1 pce) kg		
1st stack	2nd stack						
		V 50/60 Hz	V DC				
		24...60	-	(1)	NF44ES-41	1SBH137004R4144	0.320
		48...130	48...130		NF44ES-12	1SBH137004R1244	0.320
		100...250	100...250		NF44ES-13	1SBH137004R1344	0.320
		250...500	250...500		NF44ES-14	1SBH137004R1444	0.360
		V 50/60 Hz	V DC				
		24...60	-	(1)	NF53ES-41	1SBH137004R4153	0.320
		48...130	48...130		NF53ES-12	1SBH137004R1253	0.320
		100...250	100...250		NF53ES-13	1SBH137004R1353	0.320
		250...500	250...500		NF53ES-14	1SBH137004R1453	0.360
		V 50/60 Hz	V DC				
		24...60	-	(1)	NF62ES-41	1SBH137004R4162	0.320
		48...130	48...130		NF62ES-12	1SBH137004R1262	0.320
		100...250	100...250		NF62ES-13	1SBH137004R1362	0.320
		250...500	250...500		NF62ES-14	1SBH137004R1462	0.360
		V 50/60 Hz	V DC				
		24...60	-	(1)	NF71ES-41	1SBH137004R4171	0.320
		48...130	48...130		NF71ES-12	1SBH137004R1271	0.320
		100...250	100...250		NF71ES-13	1SBH137004R1371	0.320
		250...500	250...500		NF71ES-14	1SBH137004R1471	0.360
		V 50/60 Hz	V DC				
		24...60	-	(1)	NF80ES-41	1SBH137004R4180	0.320
		48...130	48...130		NF80ES-12	1SBH137004R1280	0.320
		100...250	100...250		NF80ES-13	1SBH137004R1380	0.320
		250...500	250...500		NF80ES-14	1SBH137004R1480	0.360

(1) For 24...60 V 50/60 Hz - 20...60 V DC, use NF..ES-11 (see voltage code table).
NF..ES-11 not suitable for direct control by PLC-output.

Main dimensions mm, inches

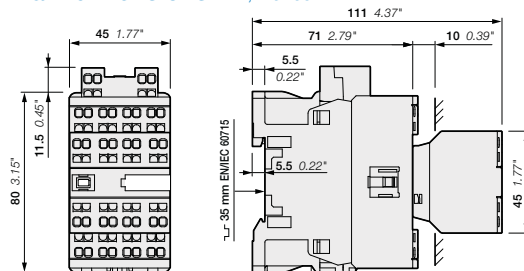

NF44ES, NF53ES, NF62ES, NF71ES, NF80ES

NFZ..S 8-pole contactor relays - with spring terminals AC / DC operated - low consumption



NFZ44ES

Description

NFZ..S contactor relays are used for switching auxiliary and control circuits.

These contactor relays are of the block type design with:

- 8 poles with a permanently fixed 4-pole auxiliary contact block. Contactor relays have mechanically linked auxiliary contact elements (side-marked symbol)
- control circuit: AC or DC operated with electronic coil interface accepting a wide control voltage range (e.g. 100...250 V AC and DC)
 - can manage large control voltage variations
 - only 4 control voltage ranges covering 24...250 V 50/60 Hz and 12...250 V DC
 - allow direct control by PLC-output ≥ 24 V DC 500 mA
 - reduced panel energy consumption
 - very distinct closing and opening
 - can withstand short voltage dips and voltage sags (SEMI F47-0706 conditions of use on request).
- built-in surge suppression
- add-on auxiliary contact blocks for side mounting and a wide range of accessories.

Ordering details

Number of contacts		Rated control circuit voltage Uc min. ... Uc max.	Type	Order code	Weight Pkg (1 pce) kg	
1st stack	2nd stack					
		V 50/60 Hz	V DC			
		-	12...20	NFZ44ES-20	1SBH136004R2044	0.360
		24...60	20...60	NFZ44ES-21	1SBH136004R2144	0.360
		48...130	48...130	NFZ44ES-22	1SBH136004R2244	0.360
		100...250	100...250	NFZ44ES-23	1SBH136004R2344	0.360
		-	12...20	NFZ53ES-20	1SBH136004R2053	0.360
		24...60	20...60	NFZ53ES-21	1SBH136004R2153	0.360
		48...130	48...130	NFZ53ES-22	1SBH136004R2253	0.360
		100...250	100...250	NFZ53ES-23	1SBH136004R2353	0.360
		-	12...20	NFZ62ES-20	1SBH136004R2062	0.360
		24...60	20...60	NFZ62ES-21	1SBH136004R2162	0.360
		48...130	48...130	NFZ62ES-22	1SBH136004R2262	0.360
		100...250	100...250	NFZ62ES-23	1SBH136004R2362	0.360
		-	12...20	NFZ71ES-20	1SBH136004R2071	0.360
		24...60	20...60	NFZ71ES-21	1SBH136004R2171	0.360
		48...130	48...130	NFZ71ES-22	1SBH136004R2271	0.360
		100...250	100...250	NFZ71ES-23	1SBH136004R2371	0.360
		-	12...20	NFZ80ES-20	1SBH136004R2080	0.360
		24...60	20...60	NFZ80ES-21	1SBH136004R2180	0.360
		48...130	48...130	NFZ80ES-22	1SBH136004R2280	0.360
		100...250	100...250	NFZ80ES-23	1SBH136004R2380	0.360

Note: Only NFZ..S contactor relays with DC control voltage 12...20 V DC need to respect the connection polarities indicated close to the coil terminals: A1+ for the positive pole and A2- for the negative pole.

Main dimensions mm, inches

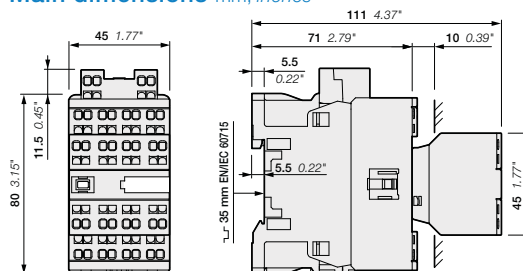

NFZ44ES, NFZ53ES, NFZ62ES, NFZ71ES, NFZ80ES

NF..S contactor relays - with spring terminals

Main accessories

Contactor relays and main accessories (other accessories available)

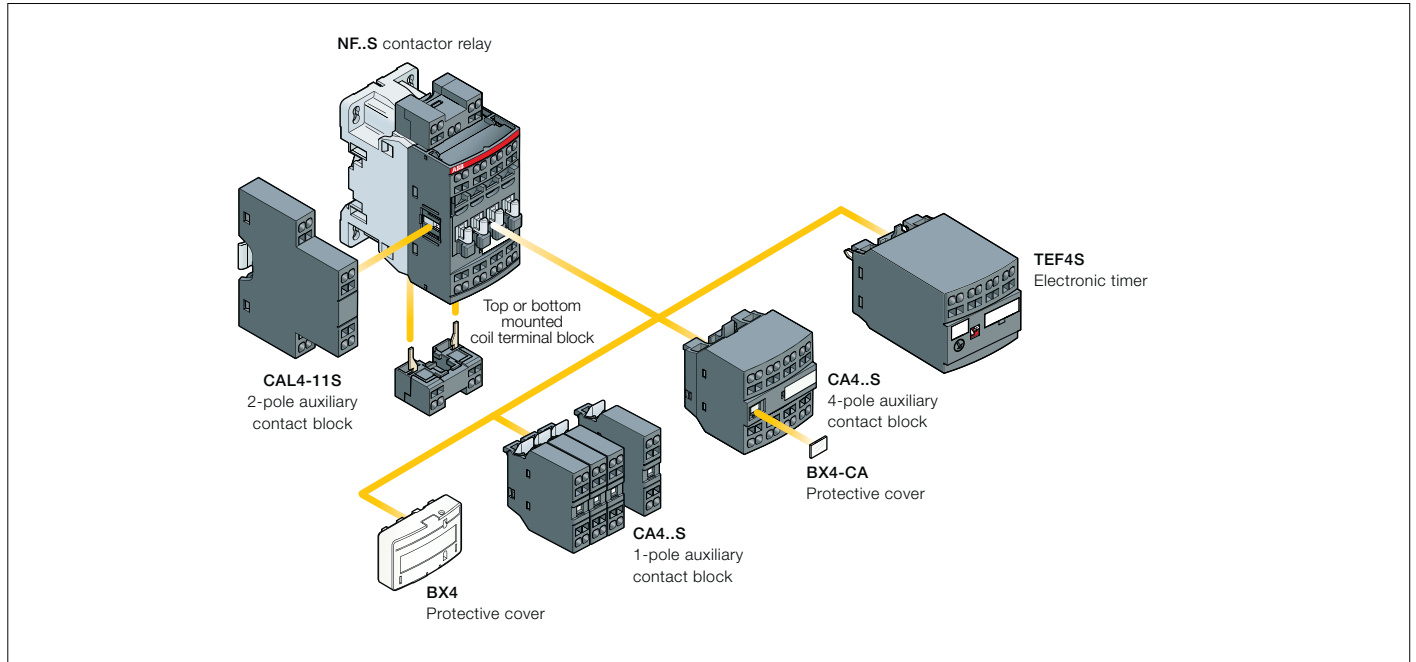

Main accessory fitting details

Many configurations of accessories are possible depending on whether these are front-mounted or side-mounted.

Contactor relay types	Main poles	Front-mounted accessories			Side-mounted accessories	
		Auxiliary contact blocks		Electronic timer	Auxiliary contact blocks	
		1-pole CA4..S	4-pole CA4..S	TEF4S	Left side 2-pole CAL4-11S	Right side
Max. add-on N.C. auxiliary contacts: 3 N.C. max. on positions 1, 2, 3, 4 and 2 N.C. max. on positions 1 ±30°, 5						
NF..	2 2 ES 3 1 ES	4 max. 2 max.	or 1 -	or 1 or 1	+ 1 + 1	- + 1
Max. add-on N.C. auxiliary contacts: 4 N.C. max. on positions 1, 2, 3, 4 and 3 N.C. max. on positions 1 ±30°, 5						
NF..	4 0 ES	4 max. 2 max.	or 1 -	or 1 or 1	+ 1 + 1	- + 1
NF..	4 4 ES 5 3 ES 6 2 ES 7 1 ES 8 0 ES	-	-	-	1	-

NF..S contactor relays - with spring terminals

Main accessories



CA4-10S



CA4-22NS



CAL4-11S



TEF4S-OFF



LDC4S





BX4



BX4-CA

Ordering details (1)

For contactor relays	Auxiliary contacts	Type	Order code	Pkg qty	Weight (1 pce)
	 				kg



Front-mounted instantaneous auxiliary contact blocks

NF..S	1 0	CA4-10S	1SBN010119R1010	1	0.016
	1 0	CA4-10S-T	1SBN010119T1010	10	0.016
	0 1	CA4-01S	1SBN010119R1001	1	0.016
	0 1	CA4-01S-T	1SBN010119T1001	10	0.016
NF..S	2 2	CA4-22NS	1SBN010145R1222	1	0.060
	3 1	CA4-31NS	1SBN010145R1231	1	0.060
	4 0	CA4-40NS	1SBN010145R1240	1	0.060

Side-mounted instantaneous auxiliary contact blocks

NF..S	1 1	CAL4-11S	1SBN010130R1011	1	0.045
-------	-----	----------	-----------------	---	-------

Ordering details (1)

For contactor relays	Time delay range selected by switch	Delay type	Rated control circuit voltage U _c	Auxiliary contacts	Type	Order code	Pkg qty	Weight (1 pce)
			V 50/60 Hz or DC	 				kg

Front-mounted electronic timer

NF..S	0.1...1 s	ON-delay	24...240	1 1	TEF4S-ON	1SBN020113R1000	1	0.065
	1...10 s							
	10...100 s	OFF-delay	24...240	1 1	TEF4S-OFF	1SBN020115R1000	1	0.065

Ordering details (1)

For contactors	Type	Order code	Pkg qty	Weight (1 pce)
				kg

Additional coil terminal block

NF..S	LDC4S	1SBN070157T1000	10	0.010
-------	-------	-----------------	----	-------

Protective covers

All 1-stack contactor relays	BX4	1SBN110108T1000	10	0.006
For 4-pole CA4..S auxiliary contact blocks	BX4-CA	1SBN110109W1000	50	0.001

(1) See "Main accessory fitting details" table.

NF..S contactor relays - with spring terminals

Technical data

Contact utilization characteristics according to IEC

Contactor relay types	AC / DC operated	NF..S
Standards		IEC 60947-1 / 60947-5-1 and EN 60947-1 / 60947-5-1
Rated operational voltage U _e max.		690 V
Rated frequency (without derating)		50/60 Hz
Conventional free-air thermal current I _{th} θ ≤ 40 °C		16 A
le / Rated operational current AC-15		
acc. to IEC 60947-5-1	24-127 V 50/60 Hz	6 A
	220-240 V 50/60 Hz	4 A
	400-440 V 50/60 Hz	3 A
	500 V 50/60 Hz	2 A
	690 V 50/60 Hz	2 A
Rated making capacity AC-15		10 x I _e AC-15 acc. to IEC 60947-5-1
Rated breaking capacity AC-15		10 x I _e AC-15 acc. to IEC 60947-5-1
le / Rated operational current DC-13		
acc. to IEC 60947-5-1	24 V DC	6 A / 144 W
	48 V DC	2.8 A / 134 W
	72 V DC	1 A / 72 W
	110 V DC	0.55 A / 60 W
	125 V DC	0.55 A / 69 W
	220 V DC	0.27 A / 60 W
	250 V DC	0.27 A / 68 W
	400 V DC	0.15 A / 60 W
	500 V DC	0.13 A / 65 W
	600 V DC	0.1 A / 60 W
Short-circuit protection device gG type fuse		10 A
Rated short-time withstand current I _{cw}	for 1.0 s	100 A
	for 0.1 s	140 A
Minimum switching capacity		12 V / 3 mA
with failure rate acc. to IEC 60947-5-4		10 ⁻⁷
Non-overlapping time between N.O. and N.C. contacts		≥ 2 ms
Power dissipation per pole at 6 A		0.1 W
Max. electrical switching frequency	AC-15	1200 cycles/h
	DC-13	900 cycles/h
Mechanically linked contacts		Built-in N.O. or N.C. auxiliary contacts and additional N.O. or N.C. auxiliary contacts (CA4..S, CAL4..S aux. contact blocks) are mechanically linked contacts
(acc. to annex L of IEC 60947-5-1)		

Contact utilization characteristics according to UL / CSA

Contactor relay types	AC / DC operated	NF..S
Standards		UL 508, CSA C22.2 N°14
Max. operational voltage		600 V AC, 600 V DC
Pilot duty		A600, Q600
AC thermal rated current		10 A
AC maximum volt-ampere making		7200 VA
AC maximum volt-ampere breaking		720 VA
DC thermal rated current		2.5 A
DC maximum volt-ampere making-breaking		69 VA

NF..S contactor relays - with spring terminals

Technical data

General technical data

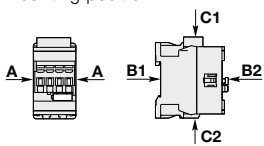
Contactor relay types	AC / DC operated	NF..S
Rated insulation voltage U_i acc. to IEC 60947-5-1 acc. to UL/CSA		690 V 600 V
Rated impulse withstand voltage U_{imp}.		6 kV
Electromagnetic compatibility		Devices complying with IEC 60947-1 / EN 60947-1 - Environment A and B (1)
Ambient air temperature close to contactor relay Operation in free air Storage		-40...+70 °C -60...+80 °C
Climatic withstand		Category B according to IEC 60947-1 Annex Q
Maximum operating altitude (without derating)		3000 m
Mechanical durability Number of operating cycles Max. switching frequency		20 millions operating cycles 6000 cycles/h
Shock withstand acc. to IEC 60068-2-27 and EN 60068-2-27 Mounting position 1	Shock direction	1/2 sinusoidal shock for 11 ms: no change in contact position, closed or open position
	A	30 g
	B1	25 g closed position / 5 g open position
	B2	15 g
	C1	25 g
	C2	25 g
Vibration withstand acc. to IEC 60068-2-6		5...300 Hz 4 g closed position / 2 g open position

(1) Environment B: all NF contactor relays produced since week 08-2013. NF..E-12 (48...130 V 50/60 Hz-DC) compliant to environment A only.
For environment B: select NF..E-22.

Magnet system characteristics

Contactor relay types	AC / DC operated	NF..S
Coil operating limits acc. to IEC 60947-5-1	AC supply	at $\theta \leq 60$ °C 0.85 x U_c min...1.1 x U_c max. at $\theta \leq 70$ °C 0.85 x U_c min... U_c max.
	DC supply	at $\theta \leq 60$ °C 0.85 x U_c min...1.1 x U_c max. at $\theta \leq 70$ °C (NF) 0.85 x U_c min... U_c max - (NFZ) 0.85 x U_c min...1.1 x U_c max.
AC control voltage Rated control circuit voltage U_c 50/60 Hz	Average pull-in value Average holding value	24...500 V AC (NF) 50 VA - (NFZ) 16 VA (NF) 2.2 VA / 2 W - (NFZ) 1.7 VA / 1.5 W
DC control voltage Rated control circuit voltage U_c Coil consumption	Average pull-in value Average holding value	12...500 V DC (NF) 50 W - (NFZ) 12...16 W (NF) 2 W - (NFZ) 1.7 W
PLC-output control		(NFZ) ≥ 500 mA 24 V DC
Drop-out voltage		≤ 60 % of U_c min.
Voltage sag immunity acc. to SEMI F47-0706		(NFZ) conditions of use on request
Dips withstand -20 °C $\leq \theta \leq +60$ °C		(NFZ) 22 ms average for $U_c \geq 24$ V 50/60 Hz or $U_c \geq 20$ V DC
Operating time Between coil energization and:	N.O. contact closing N.C. contact opening	40...95 ms 38...90 ms
Between coil de-energization and:	N.O. contact opening N.C. contact closing	11...95 ms 13...98 ms



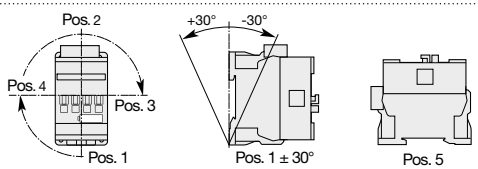



Mounting characteristics

Contactor relay types	AC / DC operated	NF..S
Mounting positions		
Mounting distances		Max. add-on N.C. auxiliary contacts: see accessory fitting details for a NF..S contactor relay The contactor relays can be assembled side by side.
Fixing On rail according to IEC 60715, EN 60715 By screws (not supplied)		35 x 7.5 mm or 35 x 15 mm 2 x M4 screws placed diagonally

NF..S contactor relays - with spring terminals

Technical data

Connecting characteristics

Contactor relay types	AC / DC operated	NF..S
Main terminals		
		 <p>Spring terminals</p>
Connection capacity (min. ... max.)		
Pole and coil terminals		
 Rigid	1 x	1...2.5 mm ²
 Rigid	2 x	1...2.5 mm ²
 Flexible with non insulated ferrule	1 x	0.75...2.5 mm ²
 Flexible with non insulated ferrule	2 x	0.75...2.5 mm ²
 Flexible with insulated ferrule	1 x	0.75...1.5 mm ²
 Flexible with insulated ferrule	2 x	0.75...1.5 mm ²
Connection capacity acc. to UL/CSA	1 or 2 x	AWG 18...12
Stripping length		10 mm
Degree of protection		
acc. to IEC 60947-1 / EN 60947-1 and IEC 60529 / EN 60529		
All terminals		IP20
Screwdriver type		Flat Ø 3.5

NF..S contactor relays - with spring terminals

Terminal marking and positioning

Standard devices without addition of auxiliary contacts

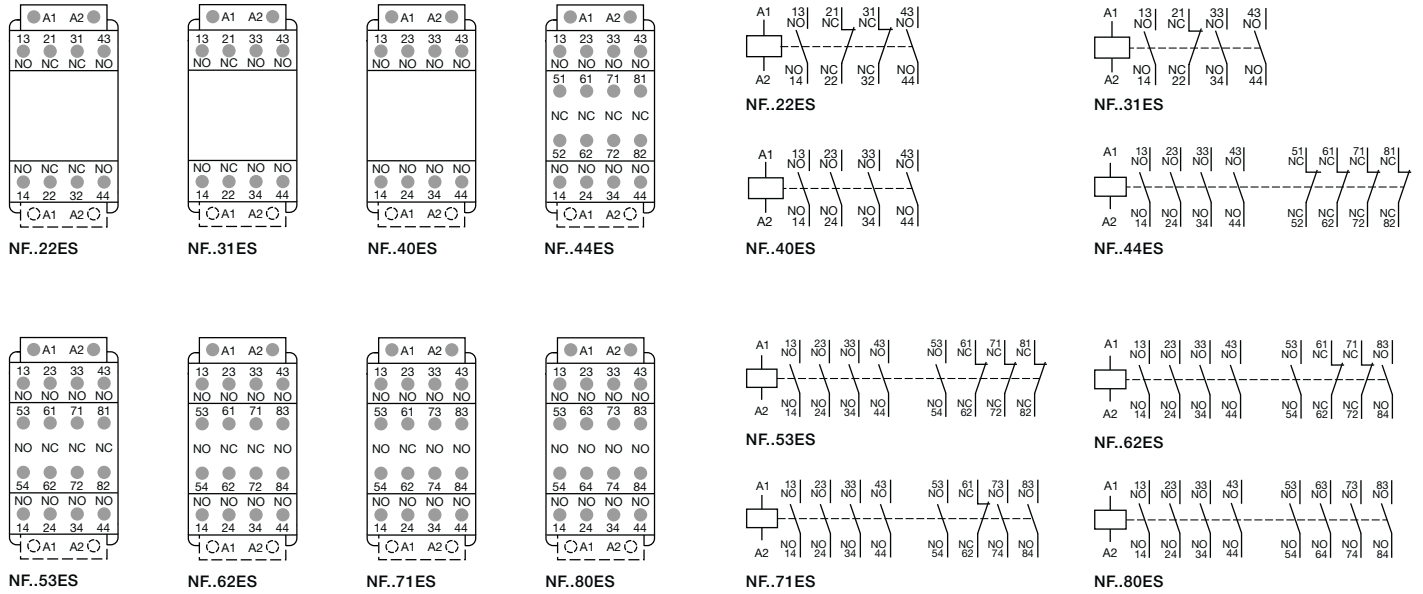

Other possible contact combinations with auxiliary contacts added by the user

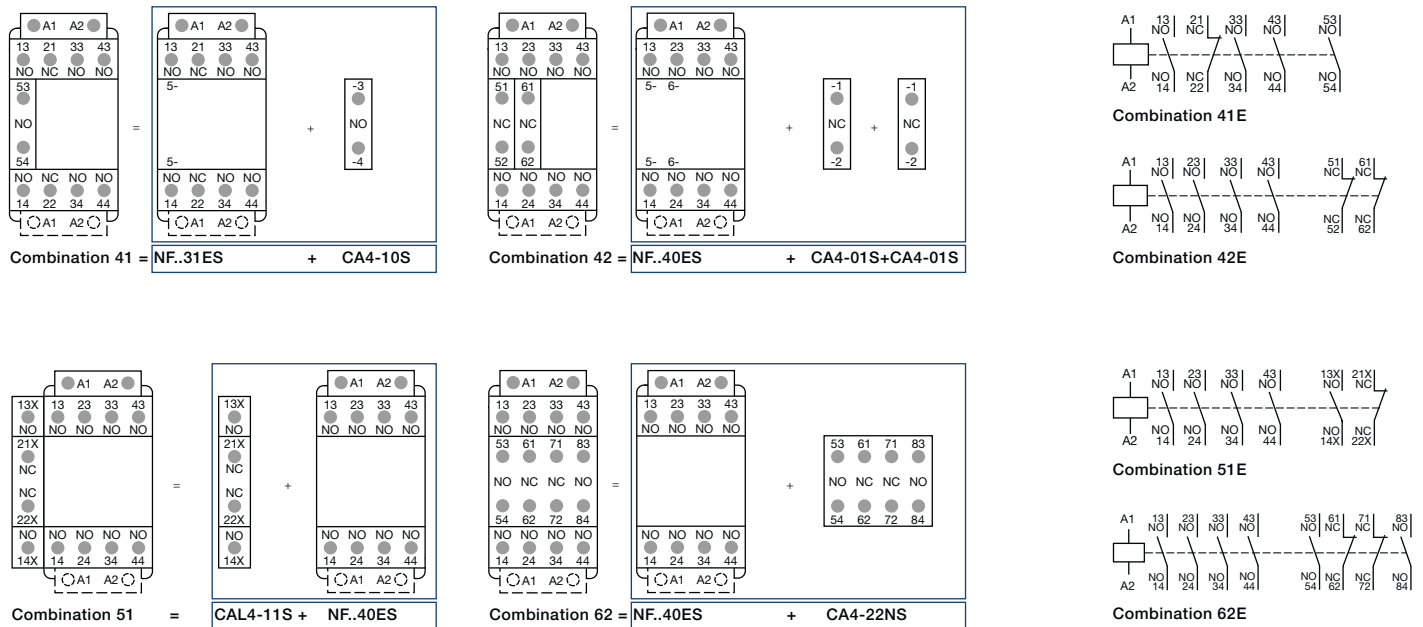

Note: Only NFZ contactor relays with DC control voltage 12...20 V DC need to respect the connection polarities indicated close to the coil terminals: A1+ for the positive pole and A2- for the negative pole.

NF..S contactor relays - with spring terminals

Main dimensions mm, inches

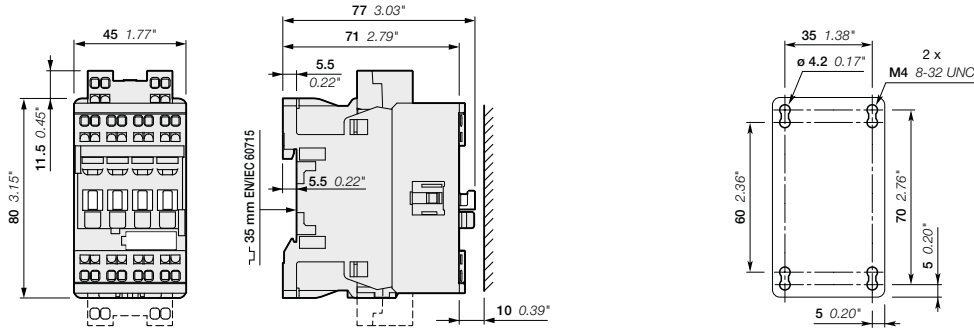

NF..22ES, NF..31ES, NF..40ES

6

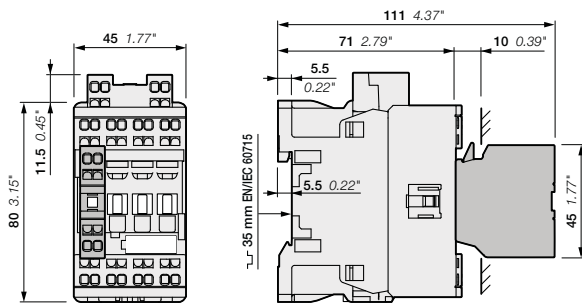

NF..22ES, NF..31ES, NF..40ES
+ CA4..S 1-pole auxiliary contact block

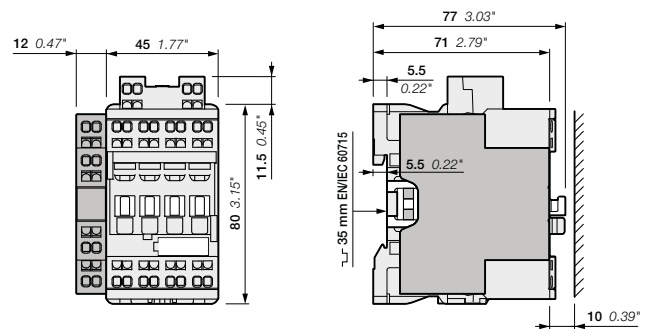

NF..22ES, NF..31ES, NF..40ES
+ CAL4-11S 2-pole auxiliary contact block

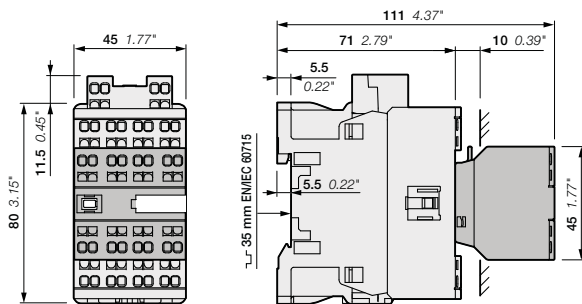

NF..22ES, NF..31ES, NF..40ES
+ CA4..S 4-pole auxiliary contact block

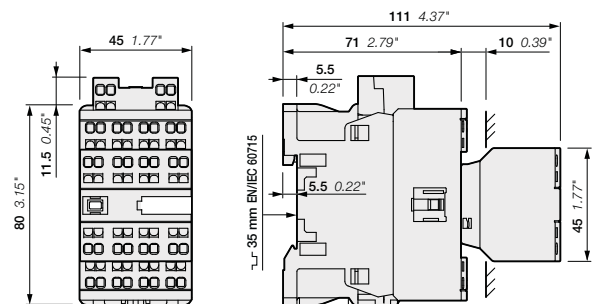

NF..44ES, NF..53ES, NF..62ES, NF..71ES, NF..80ES

Note: Contactor relay lateral distance to grounded component 2 mm 0.08" min.

NF..S contactor relays - with spring terminals

Main dimensions mm, inches

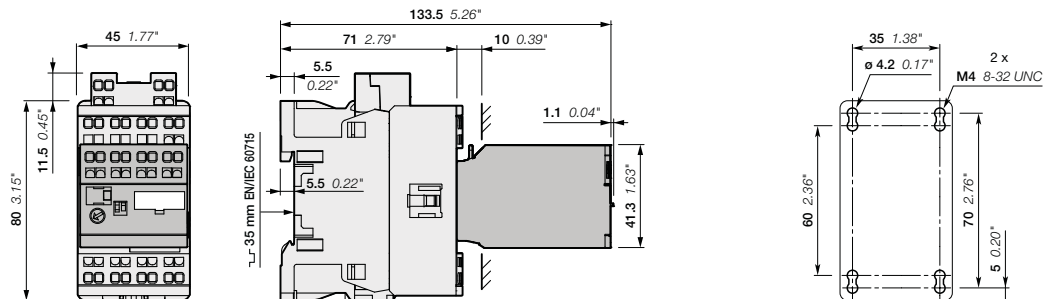

NF..22ES, NF..31ES, NF..40ES
+ TEF4S

Note: Contactor relay lateral distance to grounded component 2 mm 0.08 inches min.

Auxiliary contact blocks - with spring terminals



Description

The auxiliary contact blocks are used for the operation of auxiliary and control circuits for standard industrial environments.

Types of auxiliary contact blocks for front mounting:

- CA4..S 1 or 4-pole block, with instantaneous N.O., N.C. contacts
- CAT4..S 2-pole block, front-mounted, instantaneous N.O. + N.C. contacts with A1 / A2 coil terminal connection on front face
- CAL4..S 2-pole block, with instantaneous N.O. + N.C. contacts clipped onto the right and/or left side of the contactors.

Select the type of 2 or 4-pole auxiliary contact blocks CAT4 or CA4 (-..ES, -..MS, -..US or -..NS) according to the device type for compliance with the standard requirements (see terminal and marking positioning).

The auxiliary contact blocks are equipped with spring terminals protected against accidental direct contact and bear the corresponding function marking.

Ordering details (1)

For contactors	Auxiliary contacts	Type	Order code	Pkg qty	Weight (1 pce)
					kg

Front-mounted instantaneous auxiliary contact blocks

AF09..S ... AF38..S 4-pole NF..S	1 0 - -	CA4-10S	1SBN010119R1010	1	0.016
	1 0 - -	CA4-10S-T	1SBN010119T1010	10	0.016
	0 1 - -	CA4-01S	1SBN010119R1001	1	0.016
	0 1 - -	CA4-01S-T	1SBN010119T1001	10	0.016
AF09 ... AF16..-30-10S	2 2 - -	CA4-22MS	1SBN010145R1122	1	0.060
	3 1 - -	CA4-31MS	1SBN010145R1131	1	0.060
AF26..S	2 2 - -	CA4-22ES	1SBN010145R1022	1	0.060
	3 1 - -	CA4-31ES	1SBN010145R1031	1	0.060
	4 0 - -	CA4-40ES	1SBN010145R1040	1	0.060
4-pole NF..S	2 2 - -	CA4-22NS	1SBN010145R1222	1	0.060
	3 1 - -	CA4-31NS	1SBN010145R1231	1	0.060
	4 0 - -	CA4-40NS	1SBN010145R1240	1	0.060

Side-mounted instantaneous auxiliary contact blocks

AF09..S ... AF26..S NF..S	1 1 - -	CAL4-11S	1SBN010130R1011	1	0.045
------------------------------	---------	----------	-----------------	---	-------

Front-mounted instantaneous auxiliary contact and A1/A2 coil terminal blocks

AF09 ... AF16..-30-10S	1 1 - -	CAT4-11MS	1SBN010153R1111	1	0.045
AF26..S	1 1 - -	CAT4-11ES	1SBN010153R1011	1	0.045
AF09 ... AF16..-30-01S	1 1 - -	CAT4-11US	1SBN010153R1311	1	0.045

(1) For each contactor or contactor relay type, refer to "Accessory fitting details" table.

Note: CAT4..S not fittable on AF..Z contactors with DC control voltage 12...20 V DC.

Auxiliary contact blocks - with spring terminals

Technical data

Types	1-pole CA4..S, 4-pole CA4..S, 2-pole CAT4..S, 2-pole CAL4..S
-------	--







Contact utilization characteristics according to IEC

Standards	IEC 60947-5-1 and EN 60947-5-1	
Rated insulation voltage U_i acc. to IEC 60947-5-1	690 V	
Rated impulse withstand voltage U_{imp}	6 kV	
Rated operational voltage U_e max.	24 ... 690 V	
Conventional thermal current I_{th} - $\theta \leq 40^\circ\text{C}$	16 A	
Rated frequency (without derating)	50/60 Hz	
I_e / Rated operational current AC-15 acc. to IEC 60947-5-1	24-127 V 50/60 Hz	6 A
	220-240 V 50/60 Hz	4 A
	400-440 V 50/60 Hz	3 A
	500 V 50/60 Hz	2 A
	690 V 50/60 Hz	2 A
Making capacity	10 x I_e AC-15 acc. to IEC 60947-5-1	
Breaking capacity	10 x I_e AC-15 acc. to IEC 60947-5-1	
I_e / Rated operational current DC-13 acc. to IEC 60947-5-1	24 V DC	6 A / 144 W
	48 V DC	2.8 A / 134 W
	72 V DC	1 A / 72 W
	110 V DC	0.55 A / 60 W
	125 V DC	0.55 A / 69 W
	220 V DC	0.27 A / 60 W
	250 V DC	0.27 A / 68 W
	400 V DC	0.15 A / 60 W
	500 V DC	0.13 A / 65 W
	600 V DC	0.1 A / 60 W
Short-circuit protection device gG type fuse	10 A	
Rated short-time withstand current I_{cw} $\theta = 40^\circ\text{C}$	for 1.0 s	100 A
	for 0.1 s	140 A
Minimum switching capacity with failure rate acc. to IEC 60947-5-4	12 V / 3 mA	
Power dissipation per pole at 6 A	10^{-7}	
Mechanical durability	Number of operating cycles	10 millions operating cycles
	Max. switching frequency	3600 cycles/h
Max. electrical switching frequency	AC-15	1200 cycles/h
	DC-13	900 cycles/h
Mechanically linked contacts acc. to annex L of IEC 60947-5-1	Additional N.O. or N.C. auxiliary contacts (CA4..S, CAL4..S, CAT4..S) are mechanically linked contacts	
Mirror contacts acc. to annex F of IEC 60947-4-1	Additional N.C. auxiliary contacts (CA4..S, CAL4..S, CAT4..S) are mirror contacts	

Contact utilization characteristics according to UL / CSA

Standards	UL 508, CSA C22.2 N°14
Max. operational voltage	600 V AC, 600 V DC
Pilot duty	A600, Q600
AC thermal rated current	10 A
AC maximum volt-ampere making	7200 VA
AC maximum volt-ampere breaking	720 VA
DC thermal rated current	2.5 A
DC maximum volt-ampere making-breaking	69 VA

Connecting characteristics

Connection capacity (min. ... max.)		
 Rigid solid	1 x	1 ... 2.5 mm ²
 Rigid solid	2 x	1 ... 2.5 mm ²
 Flexible with ferrule	1 x	0.75 ... 2.5 mm ²
 Flexible with ferrule	2 x	0.75 ... 2.5 mm ²
 Flexible with insulated ferrule	1 x	0.75 ... 2.5 mm ²
 Flexible with insulated ferrule	2 x	0.75 ... 1.5 mm ²
Connection capacity acc. to UL/CSA	1 or 2 x	AWG 18 ... 14
Stripping length	10 mm	
Degree of protection	IP20	
acc. to IEC 60947-1 / EN 60947-1 and IEC 60529 / EN 60529		
Screwdriver type	Flat Ø 3.5	

Auxiliary contact blocks for AF09..S ... AF26..S contactors and NF..S contactor relays - with spring terminals

Electrical durability

Electrical durability for AC-15 utilization category

AC-15 utilization category according to IEC 60947-5-1 / EN 60947-5-1:

- making current: $10 \times I_e$ with $\cos \phi = 0.7$ and U_e
- breaking current: I_e with $\cos \phi = 0.4$ and U_e .

These curves represent the electrical durability of the built-in or add-on auxiliary contacts in relation to the breaking current. The curves have been drawn for resistive and inductive loads up to 690 V, 40...60 Hz.

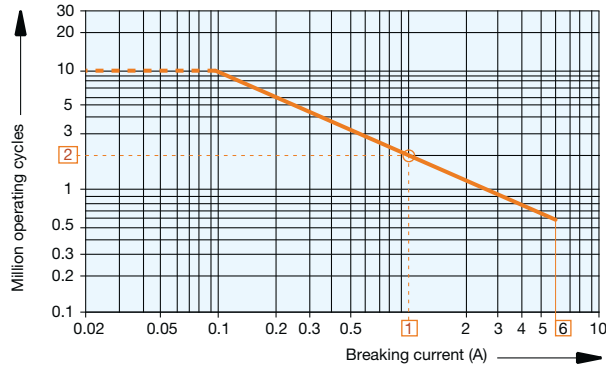

- AF09..S ... AF26..S contactor built-in auxiliary contacts
- 1-pole and 4-pole CA4..S, 2-pole CAT4..S, 2-pole CAL4..S add-on auxiliary contacts.

Example:

Breaking current = 1 A

On the opposite curve at intersection "O" 1 A the corresponding value for the electrical durability is approximately 2 millions operating cycles.

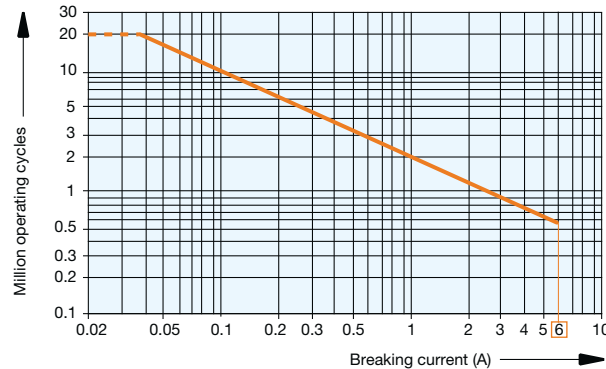

NF..S contactor relays.

(For add on auxiliary contacts see curve above).

Electrical durability for DC-13 utilization category

DC-13 utilization category according to IEC 60947-5-1 / EN 60947-5-1: making and breaking current I_e and U_e .

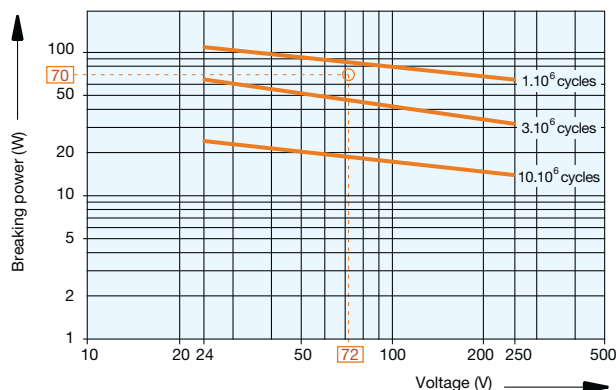

- AF09..S ... AF26..S contactor built-in auxiliary contacts
- 1-pole and 4-pole CA4..S, 2-pole CAT4..S, 2-pole CAL4..S add-on auxiliary contacts,
- NF..S contactor relays.

Example:

Control of DC electro-magnet:

U_e voltage = 72 V DC and breaking power = 70 W.

On the opposite curve at intersection "O" 72 V / 70 W the corresponding value for the electrical durability is approximately 2 millions operating cycles.

Add-on auxiliary contacts - with spring terminals

Terminal marking and positioning

1-pole auxiliary contacts

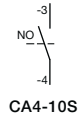
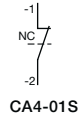

2-pole auxiliary contacts

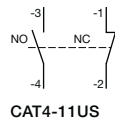
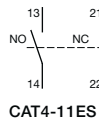
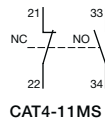
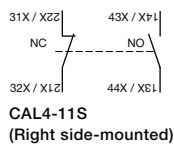
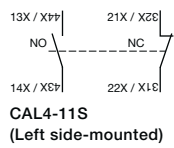

4-pole auxiliary contacts

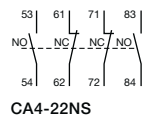
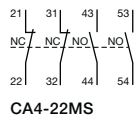
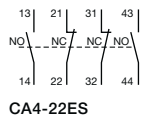
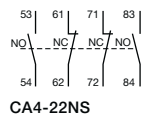
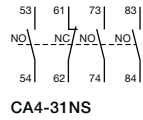
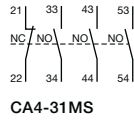
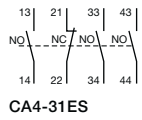
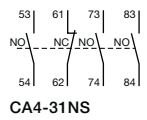
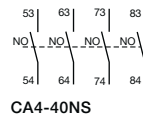
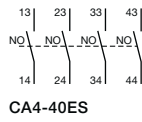
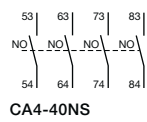

Electronic timers - with spring terminals



TEF4S-ON

1SBC101394F0014

Description

TEF4S frontal electronic timers are used for realizing timing function and are available in ON-delay and OFF-delay versions.

Compact solution in cabinet compared to separate timers

TEF4S electronic timers are front-mounted and locked on AF..S contactors or NF..S contactor relays. A mechanical indicator allows to show the state of the contactor.

Safe and cost-reduced wiring

TEF4S electronic timers are supplied by a direct plug-in parallel connection to the coil terminals A1 - A2 of the contactor or contactor relay. A varistor is integrated on the timer to offer a built-in protection against surges in the contactor coil.

Available for a wide control voltage range 24...240 V AC/DC



TEF4S-ON or TEF4S-OFF allow time-delayed functions up to 100 s in 3 distinct time ranges, independently of the control system. The time delay ranges are selected by a switch and the time delay can be adjusted by means of a rotary switch. The timing function is activated by closing or opening the device on which the timer is mounted. The OFF-delay version operates without additional control supply.



TEF4S-OFF

1SBC101393F0014

Ordering details

For contactors, contactor relays	Time delay range selected by switch	Delay type	Rated control circuit voltage U _c	Auxiliary contacts	Type	Order code	Weight
			V 50/60 Hz or DC	 			Pkg (1 pce) kg
AF09..S ... AF26..S	0.1...1 s	ON-delay	24...240	1 1	TEF4S-ON	1SBN020113R1000	0.065
NF..S	1...10 s 10...100 s	OFF-delay	24...240	1 1	TEF4S-OFF	1SBN020115R1000	0.065

Electronic timers - with spring terminals

Technical data

Contact utilization characteristics according to IEC

Types	TEF4S-ON	TEF4S-OFF
Standards	IEC 60947-5-1 and EN 60947-5-1	
Rated insulation voltage U_i acc. to IEC 60947-5-1	400 V	
Rated impulse withstand voltage U_{imp}	4 kV	
Rated operational voltage U_e max.	240 V	
Rated frequency (without derating)	50 / 60 Hz	
Conventional thermal current I_{th} - $\theta \leq 40^\circ\text{C}$	5 A	
I_e / Rated operational current AC-15 acc. to IEC 60947-5-1	24-127 V 50/60 Hz	3 A
	220-240 V 50/60 Hz	1.5 A
Making capacity acc. to IEC 60947-5-1	10 x I_e AC-15	
Breaking capacity acc. to IEC 60947-5-1	10 x I_e AC-15	
I_e / Rated operational current DC-13 acc. to IEC 60947-5-1	24 V DC	1 A / 24 W
		6 A
Short-circuit protection device gG type fuse	6 A	
Rated short-time withstand current I_{cw} $\theta = 40^\circ\text{C}$	for 1.0 s	8 A
	for 0.1 s	8 A
Minimum switching capacity with failure rate acc. to IEC 60947-5-4	24 V DC	12 V / 3 mA
Power dissipation per pole at 3 A	0.1 W	
Function diagram	ON-delay	OFF-delay
Bistable relay inside. Before use, once apply U_c then switch it off in order to initialize position of the contacts.		
Control circuit voltage		
AC control voltage	Rated control circuit voltage U_c	24...240 V AC
	Average consumption	1.5 mA RMS
DC control voltage	Rated control circuit voltage U_c	24...240 V DC
	Average consumption	1.5 mA
Rated frequency limits	50 / 60 Hz	
Supply voltage range	0.85...1.1 x U_c (at $\theta \leq 70^\circ\text{C}$)	
Overvoltage protection	Varistor included	
Time delay range (t) selected by switch	0.1...1 s	<input type="checkbox"/>
	1...10 s	<input type="checkbox"/>
	10...100 s	<input type="checkbox"/>
On-load reiteration accuracy under constant conditions	$\leq 1\%$	
Minimum ON period	0.1 s	
Recovery time	0.15 s	
Ambient air temperature	Operation	-25 °C ... +70 °C
	Storage	-40 °C ... +80 °C
Climatic withstand	Category B according to IEC 60947-1 Annex Q	
Maximum operating altitude	2000 m	
Mounting positions	Mounting positions 1, 1 +/- 30°, 2, 3, 4, 5	
Shock withstand acc. to IEC 60068-2-27 and EN 60068-2-27	1/2 sinusoidal shock for 11 ms: no change in contact position Same as contactor or contactor relay	
(Mounting position 1)		
Vibration withstand acc. to IEC 60068-2-6	5...300 Hz 3 g closed position / 2 g open position	
Mechanical durability		
Number of operating cycles	5 millions operating cycles	
Max. switching frequency	3600 cycles/h	
Max. electrical switching frequency	AC-15	1200 cycles/h
	DC-13	900 cycles/h







Electronic timers - with spring terminals

Technical data

Contact utilization characteristics according to UL / CSA

Types	TEF4S-ON	TEF4S-OFF
Standards	UL 508, CSA C22.2 N°14	
Rated insulation voltage U_i acc. to UL / CSA	300 V	
Max. operational voltage	240 V	
Pilot duty	B300, R300	
AC thermal rated current	5 A	
AC maximum volt-ampere making	3600 VA	
AC maximum volt-ampere breaking	360 VA	
DC thermal rated current	1 A	
DC maximum volt-ampere making-breaking	28 VA	

Connecting characteristics

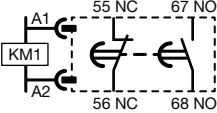
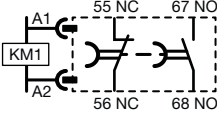
Connection capacity (min. ... max.)		
 Rigid solid	1 x	1...2.5 mm ²
 Rigid solid	2 x	1...2.5 mm ²
 Flexible with non insulated ferrule	1 x	0.75...2.5 mm ²
 Flexible with non insulated ferrule	2 x	0.75...2.5 mm ²
 Flexible with insulated ferrule	1 x	0.75...1.5 mm ²
 Flexible with insulated ferrule	2 x	0.75...1.5 mm ²
Connection capacity acc. to UL / CSA	1 or 2 x	AWG 18...14
Stripping length		10 mm
Degree of protection		IP20
acc. to IEC 60947-1 / EN 60947-1 and IEC 60529 / EN 60529		
Screwdriver type		Flat Ø 3.5
Terminal Marking		

6

Other accessories

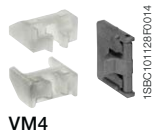

VM4



BB4



LDC4S



BX4



BX4-CA



BP38-4



BA4



BDT4

Ordering details

For contactors	Type	Order code	Pkg qty	Weight (1 pce) kg
----------------	------	------------	---------	-------------------

Mechanical interlock unit

VM4 mechanical interlock unit for the interlocking of two AF contactors. When mounted between two contactors without additional width, the VM4 mechanical interlock unit prevents one of the contactors from closing as long as the other contactor is closed. The mechanical interlock unit includes 2 fixing clips (BB4).

AF09..S ... AF26..S	VM4	1SBN030105T1000	10	0.005
---------------------	-----	-----------------	----	-------

Fixing clips

AF09..S ... AF26..S	BB4	1SBN110120W1000	50	0.002
---------------------	-----	-----------------	----	-------

Additional coil terminal block - with spring terminals

Additional coil terminal block for a bottom access to the coil terminals of contactors or contactor relays.

AF09..S ... AF26..S and NF..S	LDC4S	1SBN070157T1000	10	0.010
-------------------------------	-------	-----------------	----	-------

Protective covers

Sealable and transparent protective covers BX4 and non-removable BX4-CA to protect the devices against accidental contact.

All 1-stack contactors and contactor relays	BX4	1SBN110108T1000	10	0.006
For 4-pole CA4 and 2-pole CAT4 auxiliary contact blocks	BX4-CA	1SBN110109W1000	50	0.001

Mounting piece

Mounting piece for replacement of A / AL26 ... A / AL40 contactors fixed by screws by AF contactors in 45 mm width.

AF09..S ... AF26..S	BP38-4	1SBN112303T1000	10	0.003
---------------------	--------	-----------------	----	-------

Function markers

Box of 16 blank cards (16 markers by card) printable on HTP500 thermal transfer printer and AMS 500 marking table to identify your contactors, overload relays or manual motor starters.

Marker dimensions: 7 x 20 mm (.276" x .787").

Box of 16 blank cards	BA4	1SNA235156R2700	16	0.011
AMS 500 support plate for 8 BA4	SPRC 1	1SNA360010R1500	1	0.220
HTP500 support plate	HTP500-BA4	1SNA235712R2400	1	0.290

Test block

BDT4 test block is suitable for switching on contactor off-load.

Marking on the block indicates the contactor type to fit with.

AF..S, NF..S	BDT4	1SBN110122T1000	10	0.007
--------------	------	-----------------	----	-------

Main dimensions mm, inches

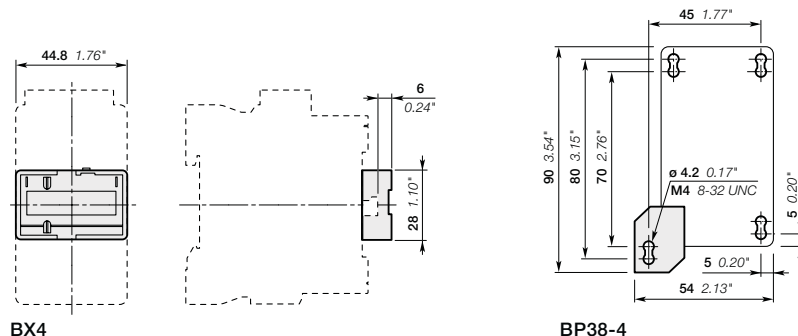

Voltage code table

The below tables indicate the available coil voltages and corresponding digits for order codes.

3-pole contactors - with spring terminals

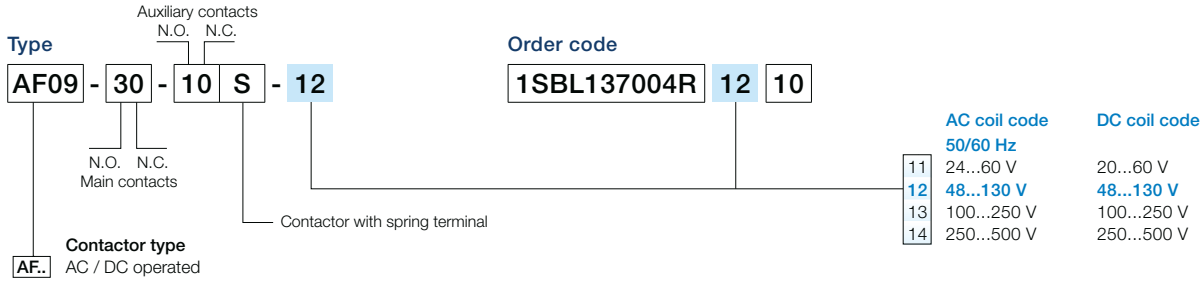

6 3-pole contactors - low consumption - with spring terminals

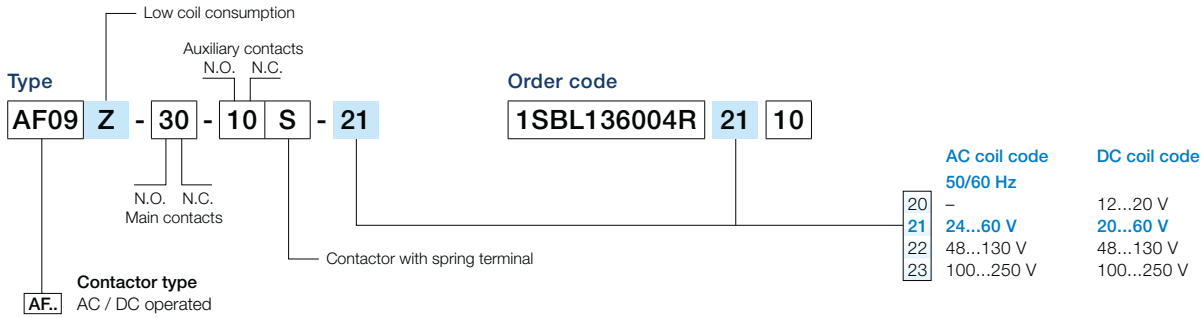

Contactor relays - with spring terminals



Contactor relays - low consumption - with spring terminals

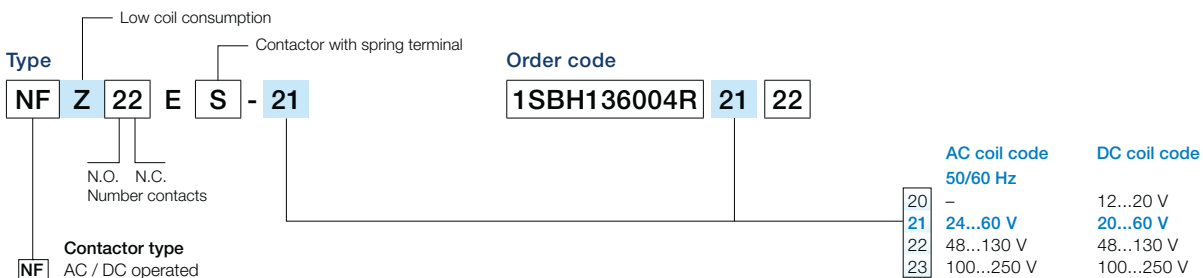

Notes

A series of horizontal dotted lines for taking notes, spanning the width of the page.



Overload relays

Overview 7/2

Thermal overload relays

T16 thermal overload relays – 0.10 to 16.0 A	7/4
TF42 thermal overload relays – 0.10 to 38.0 A	7/8
TF65 thermal overload relays – 22.0 to 67.0 A	7/12
TF96 thermal overload relays – 40.0 to 96.0 A	7/16
TF140DU thermal overload relays – 66 to 142 A	7/20
TA200DU thermal overload relays – 66 to 200 A	7/24

Electronic overload relays

E16DU, EF19, EF45 electronic overload relays – 0.10 to 45.0 A	7/28
EF65, EF96, EF146 electronic overload relays – 20 to 150 A	7/32
EF205, EF370 electronic overload relays – 63 to 380 A	7/36
EF460, EF750 electronic overload relays – 150 to 800 A	7/40
E1250DU electronic overload relays – 375 to 1250 A	7/43

General accessories 7/46

Thermal and electronic overload relays

Thermal overload relays

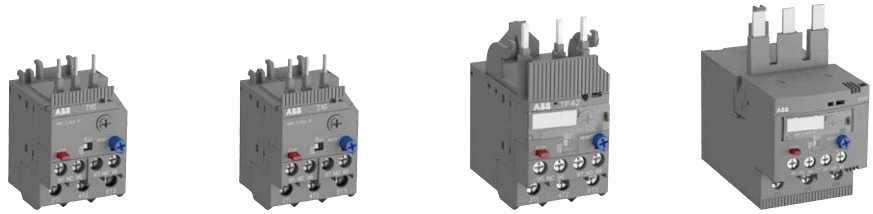

IEC: rated operational power AC-3	400 V	0.06 ... 7.5 kW	0.06 ... 7.5 kW	0.06 ... 18.5 kW	11 ... 37 kW
UL/CSA: 3-phase hp-ratings	480 V	1/2 ... 10 hp	1/2 ... 10 hp	1/2 ... 25 hp	15 ... 50 hp
Fitting to contactors		B6, B7	AS09 ... AS16	AF09 ... AF38	AF40, AF52, AF65
Type		T16	T16	TF42	TF65
Current range		0.10 ... 16 A	0.10 ... 16 A	0.10 ... 38 A	22 ... 67 A
Trip class		10	10	10	10
Single mounting kit		DB16	DB16	DB42	DB65

Electronic overload relays with integrated CT

7

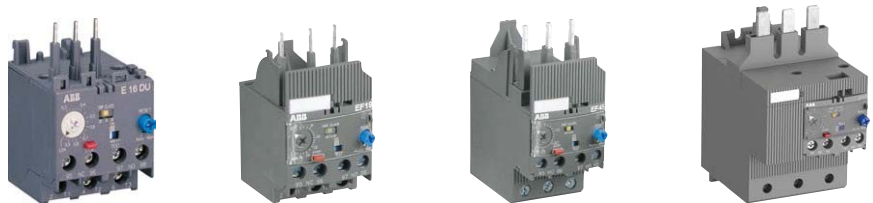

IEC: rated operational power AC-3	400 V	0.06 ... 7.5 kW	0.06 ... 7.5 kW	4 ... 22 kW	7.5 ... 37 kW
UL/CSA: 3-phase hp-ratings	480 V	1/2 ... 10 hp	1/2 ... 10 hp	5 ... 30 hp	15 ... 50 hp
Fitting to contactors		B6, B7, BC6, BC7, VB6, VB7, VBC6, VBC7	AF09 ... AF16	AF26 ... AF38	AF40, AF52, AF65
Type		E16DU	EF19	EF45	EF65
Current range		0.10 ... 18.9 A	0.10 ... 18.9 A	9 ... 45 A	20 ... 70 A
Trip class		10E, 20E, 30E selectable			
Single mounting kit		DB16E	DB19EF	DB45EF	-

Electronic overload relays with external separate CT

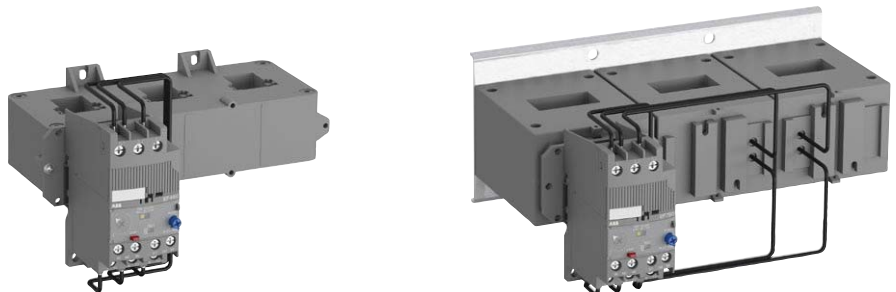

IEC: rated operational power AC-3	400 V	75 ... 250 kW	132 ... 400 kW
UL/CSA: 3-phase hp-ratings	480 V	100 ... 400 hp	200 ... 500 hp
Fitting to contactors		AF400, AF460	AF580, AF750, AF1250
Type		EF460	EF750
Current range		150 ... 500 A	250 ... 800 A
Trip class		10E, 20E, 30E selectable	



18.5 ... 45 kW

30 ... 75 hp

AF80, AF96

TF96

40 ... 96 A

10

DB96

37 ... 75 kW

50 ... 100 hp

AF116, AF140

TF140DU

66 ... 142 A

10A

-

37 ... 110 kW

50 ... 150 hp

AF190, AF205

TA200DU

66 ... 200 A

10A

DB200

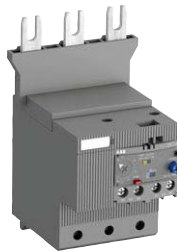

22 ... 55 kW

30 ... 75 hp

AF80, AF96

EF96

36 ... 100 A

10E, 20E, 30E selectable

DB96

30 ... 75 kW

50 ... 100 hp

AF116, AF140, AF146

EF146

54 ... 150 A

-

37 ... 110 kW

50 ... 150 hp

AF190, AF205

EF205

63 ... 210 A

-

75 ... 200 kW

100 ... 300 hp

AF265, AF305, AF370

EF370

115 ... 380 A

-

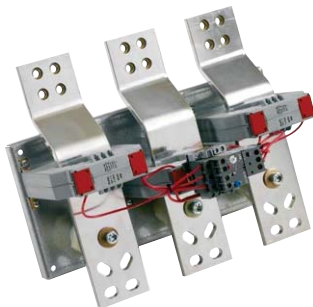

250 ... 710 kW

350 ... 500 hp

AF1350, AF1650

E1250DU

375 ... 1250 A

10E, 20E, 30E selectable

T16 thermal overload relays – 0.10 to 16.0 A

Technical data

Main circuit – Utilization characteristics according to IEC/EN

Type	T16
Standards	IEC/EN 60947-4-1, IEC/EN 60947-5-1, IEC/EN 60947-1
Rated operational voltage U_e	690 V AC - V DC
Rated frequency	50/60 Hz
Trip class	10
Number of poles	3
Duty time	100 %
Operating frequency without early tripping	Up to 15 operations/h, see "Technical diagram – Intermittent periodic duty"
Rated impulse withstand voltage U_{imp}	6 kV
Rated insulation voltage U_i	690 V AC

Auxiliary circuit according to IEC/EN

Type	T16
Rated operational voltage U_e	600 V
Conventional free air thermal current I_{th}	N.C., 95-96 6 A N.O., 97-98 4 A
Rated frequency	DC, 50/60 Hz
Number of poles	1 N.O. + 1 N.C.
I_e / Rated operational current AC-15 acc. to IEC/EN 60947-5-1 for utilization category	
110-120 V	N.C., 95-96 3.00 A N.O., 97-98 0.75 A
220-230-240 V	N.C., 95-96 3.00 A N.O., 97-98 0.75 A
440 V	N.C., 95-96 0.75 A N.O., 97-98 0.75 A
480-500 V	N.C., 95-96 0.75 A N.O., 97-98 0.75 A
I_e / Rated operational current DC-13 acc. to IEC/EN 60947-5-1 for utilization category	
24 V	N.C., 95-96 1.25 A N.O., 97-98 1.25 A
60 V	N.C., 95-96 0.55 A N.O., 97-98 0.55 A
110-120-125 V	N.C., 95-96 0.55 A N.O., 97-98 0.55 A
250 V	N.C., 95-96 0.27 A N.O., 97-98 0.27 A
Minimum switching capacity	17 V / 3 mA
Short-circuit protective device	N.C., 95-96 6 A, fuse type gG N.O., 97-98 4 A, fuse type gG
Rated impulse withstand voltage U_{imp}	6 kV
Rated insulation voltage U_i	690 V

Technical diagram – Intermittent periodic duty

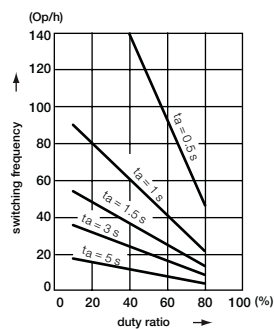

t_a : Motor starting time

T16 thermal overload relays – 0.10 to 16.0 A

Technical data

Main circuit – Utilization characteristics according to UL/CSA

Type	T16
Standards	UL 508, CSA 22.2 No. 14
Maximum operational voltage	600 V AC
Trip rating	125 % of FLA
Full load amps (FLA)	See table "Full load amps and short-circuit protective device"
Short-circuit rating RMS symmetrical	See table "Full load amps and short-circuit protective device"
Short-circuit protective device	See table "Full load amps and short-circuit protective device"

Auxiliary circuit according to UL/CSA

Type	T16
Contact rating	N.C., 95-96 B600, Q300 N.O., 97-98 D300, Q300
Conventional thermal current	N.C., 95-96 5 A N.O., 97-98 2.5 A

Full load amps and short-circuit protective device

Type	Full load amps (FLA)	Short-circuit protective device		480 / 600 V AC	
		480 / 600 V AC Short circuit rating RMS symmetrical	Fuse type	480 / 600 V AC Short circuit rating RMS symmetrical	Fuse type
T16-0.13	0.13 A	18 kA	1 A, K5	100 kA	30 A, Class J
T16-0.17	0.17 A	18 kA	1 A, K5	100 kA	30 A, Class J
T16-0.23	0.23 A	18 kA	1 A, K5	100 kA	30 A, Class J
T16-0.31	0.31 A	18 kA	3 A, K5	100 kA	30 A, Class J
T16-0.41	0.41 A	18 kA	3 A, K5	100 kA	30 A, Class J
T16-0.55	0.55 A	18 kA	3 A, K5	100 kA	30 A, Class J
T16-0.74	0.74 A	18 kA	3 A, K5	100 kA	30 A, Class J
T16-1.0	1.00 A	18 kA	6 A, K5	100 kA	30 A, Class J
T16-1.3	1.30 A	18 kA	6 A, K5	100 kA	30 A, Class J
T16-1.7	1.70 A	18 kA	6 A, K5	100 kA	30 A, Class J
T16-2.3	2.30 A	18 kA	10 A, K5	100 kA	30 A, Class J
T16-3.1	3.10 A	18 kA	10 A, K5	100 kA	30 A, Class J
T16-4.2	4.20 A	18 kA	15 A, K5	100 kA	30 A, Class J
T16-5.7	5.70 A	18 kA	20 A, K5	100 kA	30 A, Class J
T16-7.6	7.60 A	18 kA	25 A, K5	100 kA	30 A, Class J
T16-10	10.0 A	18 kA	35 A, K5	100 kA	45 A, Class J
T16-13	13.0 A	18 kA	40 A, K5	100 kA	45 A, Class J
T16-16	16.0 A	18 kA	60 A, K5	100 kA	45 A, Class J

T16 thermal overload relays – 0.10 to 16.0 A



Technical data

General technical data





Type	T16	
Pollution degree	3	
Phase loss sensitive	Yes	
Ambient air temperature		
Operation	Open - compensated	-25 ... +60 °C
	Open	-25 ... +60 °C
Storage		-50 ... +80 °C
Ambient air temperature compensation	Acc. to IEC/EN60947-4-1	
Maximum operating altitude permissible	2000 m	
Resistance to shock acc. to IEC 60068-2-27	25g / 11 ms	
Resistance to vibrations acc. to IEC 60068-2-6	3g / 3 ... 150 Hz	
Mounting position	Position 1-5	
Mounting	Mount on the contactor and tighten the screws of the main circuit terminals or with single mounting kit on DIN rail (35 mm)	
Degree of protection	Housing	IP20
	Main circuit terminals	IP10

Electrical connection

Main circuit

Type	T16	
Connecting capacity		
 Rigid	1 x	0.75 ... 4 mm ²
	2 x	0.75 ... 1.5 mm ² or 1.5 ... 4 mm ² ¹⁾
 Flexible	1 x or 2 x	0.75 ... 4 mm ²
Stranded acc. to UL/CSA	1 x or 2 x	AWG 18-10
Flexible acc. to UL/CSA	1 x or 2 x	AWG 18-10
Stripping length	12 mm	
Tightening torque	1.1 ... 1.5 Nm / 9 ... 13 lb.in	
Recommended screw driver	M4 (Pozidriv 2)	

Auxiliary circuit

Type	T16	
Connecting capacity		
 Rigid	1 x or 2 x	0.75 ... 4 mm ²
 Flexible with ferrule	1 x or 2 x	0.75 ... 2.5 mm ²
 Flexible with insulated ferrule	1 x	0.75 ... 2.5 mm ²
	2 x	0.75 ... 1.5 mm ²
 Flexible	1 x or 2 x	0.75 ... 1 mm ² or 1 ... 2.5 mm ² ¹⁾
Stranded acc. to UL/CSA	1 x or 2 x	AWG 18-12
Flexible acc. to UL/CSA	1 x or 2 x	AWG 18-12
Stripping length	9 mm	
Tightening torque	1.1 ... 1.5 Nm / 9 ... 13 lb.in	
Recommended screw driver	M3 (Pozidriv 2)	

¹⁾ Only connect two different "conductor/wire" cross-sections, if they are within the indicated ranges

TF42 thermal overload relays – 0.10 to 38.0 A

Ordering details



2CDC231006R013

TF42



2CDC231001R011

DB42

7



2CDC231026R013

TF42 + DB42



1SFC151224R002

KPR-101L

Description

The TF42 thermal overload relays are economic electromechanical protection devices for the main circuit. They offer reliable protection for motors in the event of overload or phase failure. The devices have trip class 10.

The thermal overload relays are three pole relays with bimetal tripping elements. The motor current flows through the bimetal tripping elements and heats them directly and indirectly. In case of an overload (over current), the bimetal elements bent as a result of the heating. This leads to a release of the relay and a change of the contacts switching position (95-96 / 97-98).

- Manual or automatic reset selectable
- Phase loss sensitive acc. to IEC/EN 60947-4-1
- TEST and STOP function – Trip indication on the front
- Temperature compensation
- Suitable for three- and single-phase applications
- With ATEX certification

Ordering details

Setting range	Short-circuit protective device	Trip class	Type	Order code	Weight (1 pc) kg
0.10 ... 0.13	0.5 A, fuse type T	10	TF42-0.13	1SAZ721201R1005	0.130
0.13 ... 0.17	1.0 A, fuse type T	10	TF42-0.17	1SAZ721201R1008	0.130
0.17 ... 0.23	1.0 A, fuse type T	10	TF42-0.23	1SAZ721201R1009	0.130
0.23 ... 0.31	1.0 A, fuse type T	10	TF42-0.31	1SAZ721201R1013	0.130
0.31 ... 0.41	2.0 A, fuse type gG	10	TF42-0.41	1SAZ721201R1014	0.130
0.41 ... 0.55	2.0 A, fuse type gG	10	TF42-0.55	1SAZ721201R1017	0.130
0.55 ... 0.74	4.0 A, fuse type gG	10	TF42-0.74	1SAZ721201R1021	0.130
0.74 ... 1.00	6.0 A, fuse type gG	10	TF42-1.0	1SAZ721201R1023	0.130
1.00 ... 1.30	6.0 A, fuse type gG	10	TF42-1.3	1SAZ721201R1025	0.130
1.30 ... 1.70	10.0 A, fuse type gG	10	TF42-1.7	1SAZ721201R1028	0.130
1.70 ... 2.30	10.0 A, fuse type gG	10	TF42-2.3	1SAZ721201R1031	0.130
2.30 ... 3.10	10.0 A, fuse type gG	10	TF42-3.1	1SAZ721201R1033	0.130
3.10 ... 4.20	20.0 A, fuse type gG	10	TF42-4.2	1SAZ721201R1035	0.130
4.20 ... 5.70	20.0 A, fuse type gG	10	TF42-5.7	1SAZ721201R1038	0.130
5.70 ... 7.60	35.0 A, fuse type gG	10	TF42-7.6	1SAZ721201R1040	0.130
7.60 ... 10.0	35.0 A, fuse type gG	10	TF42-10	1SAZ721201R1043	0.130
10.0 ... 13.0	40.0 A, fuse type gG	10	TF42-13	1SAZ721201R1045	0.130
13.0 ... 16.0	40.0 A, fuse type gG	10	TF42-16	1SAZ721201R1047	0.130
16.0 ... 20.0	63.0 A, fuse type gG	10	TF42-20	1SAZ721201R1049	0.145
20.0 ... 24.0	63.0 A, fuse type gG	10	TF42-24	1SAZ721201R1051	0.145
24.0 ... 29.0	63.0 A, fuse type gG	10	TF42-29	1SAZ721201R1052	0.145
29.0 ... 35.0	80.0 A, fuse type gG	10	TF42-35	1SAZ721201R1053	0.145
35.0 ... 38.0/40.0	80.0 A, fuse type gG	10	TF42-38	1SAZ721201R1055	0.145

Ordering details accessories

Suitable for	Description	Type	Order code	Weight (1 pc) kg
TF42	Single mounting kit	DB42	1SAZ701902R0001	0.087
TF42	Reset push button*	KPR-101L	1SFA616162R1014	0.027

*Note: for more information see catalog 1SFC151004C0201

Main dimensions mm, inches

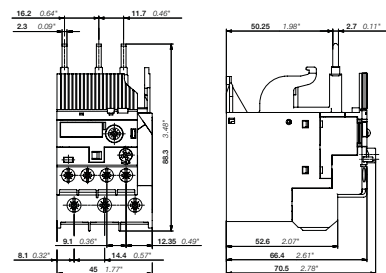

TF42

2CDC232005R0009

2CDC106046C0201

TF42 thermal overload relays – 0.10 to 38.0 A

Technical data

Main circuit – Utilization characteristics according to IEC/EN

Type	TF42
Standards	IEC/EN 60947-4-1, IEC/EN 60947-5-1, IEC/EN 60947-1
Rated operational voltage U_n	690 V AC
Rated frequency	50/60 Hz
Trip class	10
Number of poles	3
Duty time	100 %
Operating frequency without early tripping	Up to 15 operations/h, see "Technical diagram – Intermittent periodic duty"
Rated impulse withstand voltage U_{imp}	6 kV
Rated insulation voltage U_i	690 V AC

Auxiliary circuit according to IEC/EN

Type	TF42
Rated operational voltage U_n	600 V
Conventional free air thermal current I_{th}	N.C., 95-96 6 A N.O., 97-98 4 A
Rated frequency	DC, 50/60 Hz
Number of poles	1 N.O. + 1 N.C.
I_e / Rated operational current AC-15 acc. to IEC/EN 60947-5-1 for utilization category	
110-120 V	N.C., 95-96 3.00 A N.O., 97-98 0.75 A
220-230-240 V	N.C., 95-96 3.00 A N.O., 97-98 0.75 A
440 V	N.C., 95-96 0.75 A N.O., 97-98 0.75 A
480-500 V	N.C., 95-96 0.75 A N.O., 97-98 0.75 A
I_e / Rated operational current DC-13 acc. to IEC/EN 60947-5-1 for utilization category	
24 V	N.C., 95-96 1.25 A N.O., 97-98 1.25 A
110-120-125 V	N.C., 95-96 0.55 A N.O., 97-98 0.55 A
250 V	N.C., 95-96 0.27 A N.O., 97-98 0.27 A
Minimum switching capacity	17 V / 3 mA
Short-circuit protective device	N.C., 95-96 6 A, fuse type gG N.O., 97-98 4 A, fuse type gG
Rated impulse withstand voltage U_{imp}	6 kV
Rated insulation voltage U_i	690 V

Technical diagram – Intermittent periodic duty

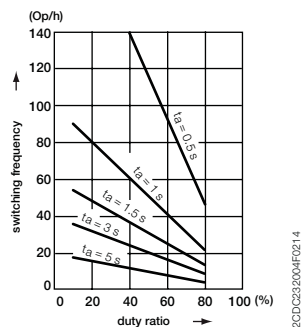

t_a : Motor starting time

TF42 thermal overload relays – 0.10 to 38.0 A

Technical data

Main circuit – Utilization characteristics according to UL/CSA

Type	TF42
Standards	UL 508, CSA 22.2 No. 14
Maximum operational voltage	600 V AC
Trip rating	125 % of FLA
Full load amps (FLA)	See table "Full load amps and short-circuit protective device"
Short-circuit rating RMS symmetrical	See table "Full load amps and short-circuit protective device"
Short-circuit protective device	See table "Full load amps and short-circuit protective device"

Auxiliary circuit according to UL/CSA

Type	TF42
Contact rating	N.C., 95-96 B600, Q300 N.O., 97-98 D300, Q300
Conventional thermal current	N.C., 95-96 5 A N.O., 97-98 2.5 A

Full load amps and short-circuit protective device

Type	Full load amps (FLA)	Short-circuit protective device		480 / 600 V AC	
		480 / 600 V AC Short circuit rating RMS symmetrical	Fuse type	480 / 600 V AC Short circuit rating RMS symmetrical	Fuse type
TF42-0.13	0.13 A	18 kA	1 A, K5	100 kA	30 A, Class J
TF42-0.17	0.17 A	18 kA	1 A, K5	100 kA	30 A, Class J
TF42-0.23	0.23 A	18 kA	1 A, K5	100 kA	30 A, Class J
TF42-0.31	0.31 A	18 kA	3 A, K5	100 kA	30 A, Class J
TF42-0.41	0.41 A	18 kA	3 A, K5	100 kA	30 A, Class J
TF42-0.55	0.55 A	18 kA	3 A, K5	100 kA	30 A, Class J
TF42-0.74	0.74 A	18 kA	3 A, K5	100 kA	30 A, Class J
TF42-1.0	1.00 A	18 kA	6 A, K5	100 kA	30 A, Class J
TF42-1.3	1.30 A	18 kA	6 A, K5	100 kA	30 A, Class J
TF42-1.7	1.70 A	18 kA	6 A, K5	100 kA	30 A, Class J
TF42-2.3	2.30 A	18 kA	10 A, K5	100 kA	30 A, Class J
TF42-3.1	3.10 A	18 kA	10 A, K5	100 kA	30 A, Class J
TF42-4.2	4.20 A	18 kA	15 A, K5	100 kA	30 A, Class J
TF42-5.7	5.70 A	18 kA	20 A, K5	100 kA	30 A, Class J
TF42-7.6	7.60 A	18 kA	25 A, K5	100 kA	30 A, Class J
TF42-10	10.0 A	18 kA	35 A, K5	100 kA	45 A, Class J
TF42-13	13.0 A	18 kA	40 A, K5	100 kA	45 A, Class J
TF42-16	16.0 A	18 kA	60 A, K5	100 kA	45 A, Class J
TF42-20	20.0 A	18 kA	80 A, K5	100 kA	60 A, Class J
TF42-24	24.0 A	18 kA	80 A, K5	100 kA	60 A, Class J
TF42-29	29.0 A	18 kA	100 A, K5	100 kA	100 A, Class J
TF42-35	35.0 A	18 kA	150 A, K5	100 kA	175 A, Class J
TF42-38	38.0 A	18 kA	150 A, K5	100 kA	175 A, Class J

TF42 thermal overload relays – 0.10 to 38.0 A





Technical data

General technical data







Type	TF42	
Pollution degree	3	
Phase loss sensitive	Yes	
Ambient air temperature		
Operation	Open - compensated	-25 ... +60 °C
	Open	-25 ... +60 °C
Storage		-50 ... +80 °C
Ambient air temperature compensation	Acc. to IEC/EN60947-4-1	
Maximum operating altitude permissible	2000 m	
Resistance to shock acc. to IEC 60068-2-27	25g / 11 ms	
Resistance to vibrations acc. to IEC 60068-2-6	3g / 3 ... 150 Hz	
Mounting position	Position 1-5	
Mounting	Mount on the contactor and tighten the screws of the main circuit terminals or with single mounting kit on DIN rail (35 mm)	
Degree of protection	Housing	IP20
	Main circuit terminals	IP10

Electrical connection

Main circuit

Type	TF42 (TF42-0.13 ... TF42-16)	TF42 (TF42-20 ... TF42-38)
Connecting capacity		
 Rigid	1 x or 2 x 0.75 ... 4 mm ²	1.5 ... 2.5 mm ² or 2.5 ... 10 mm ² ¹⁾
 Flexible with insulated ferrule	1 x or 2 x 0.75 ... 4 mm ²	2.5 ... 4 mm ² or 4 ... 6 mm ² ¹⁾
 Stranded acc. to UL/CSA	1 x or 2 x AWG 18-10	AWG 14-6
 Flexible acc. to UL/CSA	1 x or 2 x AWG 18-10	AWG 14-6
Stripping length	12 mm	
Tightening torque	1.5 - 2.5 Nm / 13 ... 22 lb.in	2.5 - 2.7 Nm / 22 lb.in
Recommended screw driver	M4 (Pozidriv 2)	

Auxiliary circuit

Type	TF42
Connecting capacity	
 Rigid	1 x or 2 x 0.75 ... 4 mm ²
 Flexible with ferrule	1 x or 2 x 0.75 ... 2.5 mm ²
 Flexible with insulated ferrule	1 x 0.75 ... 2.5 mm ²
	2 x 0.75 ... 1.5 mm ²
 Flexible	1 x or 2 x 0.75 ... 1 mm ² or 1 ... 2.5 mm ² ¹⁾
 Stranded acc. to UL/CSA	1 x or 2 x AWG 18-12
 Flexible acc. to UL/CSA	1 x or 2 x AWG 18-12
Stripping length	9 mm
Tightening torque	1.1 ... 1.5 Nm / 9 ... 13 lb.in
Recommended screw driver	M3 (Pozidriv 2)

¹⁾ Only connect two different "conductor/wire" cross-sections, if they are within the indicated ranges.

TF65 thermal overload relays – 22.0 to 67.0 A

Ordering details



2CDC231094F0013

TF65

Description

The TF65 thermal overload relays are economic electromechanical protection devices for the main circuit. They offer reliable protection for motors in the event of overload or phase failure. The devices have trip class 10.

The thermal overload relays are three pole relays with bimetal tripping elements. The motor current flows through the bimetal tripping elements and heats them directly and indirectly. In case of an overload (over current), the bimetal elements bent as a result of the heating. This leads to a release of the relay and a change of the contacts switching position (95-96 / 97-98).

- Manual or automatic reset selectable
- Phase loss sensitive acc. to IEC/EN 60947-4-1
- TEST and STOP function – Trip indication on the front
- Temperature compensation
- Suitable for three- and single-phase applications
- With ATEX certification ¹⁾

Ordering details

Setting range	Short-circuit protective device	Trip class	Type	Order code	Weight (1 pc) kg
A					
22.0 ... 28.0	80 A, gG Type Fuses	10	TF65-28	1SAZ811201R1001	0.456
25.0 ... 33.0	80 A, gG Type Fuses	10	TF65-33	1SAZ811201R1002	0.456
30.0 ... 40.0	100 A, gG Type Fuses	10	TF65-40	1SAZ811201R1003	0.456
36.0 ... 47.0	125 A, gG Type Fuses	10	TF65-47	1SAZ811201R1004	0.456
44.0 ... 53.0	125 A, gG Type Fuses	10	TF65-53	1SAZ811201R1005	0.456
50.0 ... 60.0	125 A, gG Type Fuses	10	TF65-60	1SAZ811201R1006	0.466
57.0 ... 67.0	160 A, gG Type Fuses	10	TF65-67	1SAZ811201R1007	0.466



2CDC231003V0015

DB65

Ordering details accessories

Suitable for	Description	Type	Order code	Weight (1 pc) kg
TF65	Single mounting kit	DB65	1SAZ801901R1001	0.132
TF65	Reset push button ²⁾	KPR-101L	1SFA616162R1014	0.027

¹⁾ ATEX is valid for products, produced from week 26, 2015

²⁾ Note: for more information see catalog 1SFC151004C0201



2CDC231004W0015

DB65 + TF65



1SFC151224F0002

KPR-101L

Main dimensions mm, inches

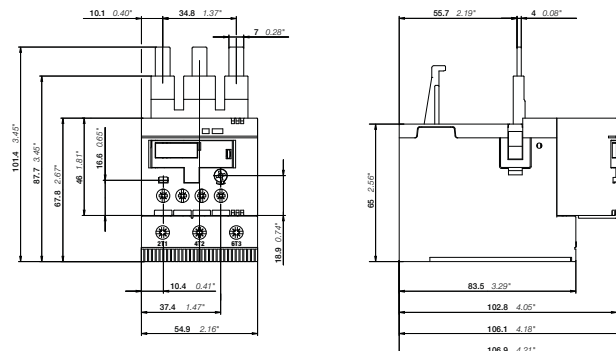

TF65

2CDC231006F0009

2CDC106063C0201

TF65 thermal overload relays – 22.0 to 67.0 A

Technical data

Main circuit – Utilization characteristics according to IEC/EN

Type	TF65
Standards	IEC/EN 60947-1, IEC/EN 60947-4-1, IEC/EN 60947-5-1
Rated operational voltage U_e	690 V AC
Rated frequency	50/60 Hz
Trip class	10
Number of poles	3
Duty time	100 %
Operating frequency without early tripping	Up to 15 operations/h, see "Technical diagram – Intermittent periodic duty"
Rated impulse withstand voltage U_{imp}	8 kV
Rated insulation voltage U_i	690 V

Auxiliary circuit according to IEC/EN

Type	TF65
Rated operational voltage U_e	600 V
Conventional free air thermal current I_{th}	N.C., 95-96 6 A N.O., 97-98 4 A
Rated frequency	DC, 50/60 Hz
Number of poles	1 N.O. + 1 N.C.
I_e / Rated operational current AC-15 acc. to IEC/EN 60947-5-1 for utilization category	
110-120 V	N.C., 95-96 3.00 A N.O., 97-98 0.75 A
220-230-240 V	N.C., 95-96 3.00 A N.O., 97-98 0.75 A
440 V	N.C., 95-96 0.75 A N.O., 97-98 0.75 A
480-500 V	N.C., 95-96 0.75 A N.O., 97-98 0.75 A
I_e / Rated operational current DC-13 acc. to IEC/EN 60947-5-1 for utilization category	
24 V	N.C., 95-96 1.25 A N.O., 97-98 1.25 A
110-120-125 V	N.C., 95-96 0.55 A N.O., 97-98 0.55 A
250 V	N.C., 95-96 0.27 A N.O., 97-98 0.27 A
Minimum switching capacity	17 V / 3 mA
Short-circuit protective device	N.C., 95-96 6 A, gG Type Fuses N.O., 97-98 4 A, gG Type Fuses
Rated impulse withstand voltage U_{imp}	6 kV
Rated insulation voltage U_i	690 V

Technical diagram – Intermittent periodic duty

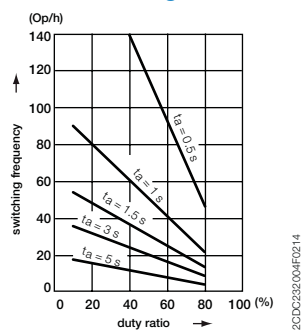

t_a : Motor starting time

TF65 thermal overload relays – 22.0 to 67.0 A

Technical data

Main circuit – Utilization characteristics according to UL/CSA

Type	TF65
Standards	UL 60947-1, UL 60947-4-1
Maximum operational voltage	600 V AC
Trip rating	125 % of FLA
Full load amps (FLA)	See table "Full load amps and short-circuit protective device"
Short-circuit rating RMS symmetrical	See table "Full load amps and short-circuit protective device"
Short-circuit protective device	See table "Full load amps and short-circuit protective device"

Auxiliary circuit according to UL/CSA

Type	TF65
Contact rating	N.C., 95-96 B600, Q600
	N.O., 97-98 D300, Q600
Conventional thermal current	N.C., 95-96 6 A
	N.O., 97-98 4 A

Full load amps and short-circuit protective device

Type	Full load amps (FLA)	Short-circuit protective device		480 / 600 V AC	
		480 / 600 V AC Short circuit rating RMS symmetrical	Fuse type	480 / 600 V AC Short circuit rating RMS symmetrical	Fuse type
TF65-28	28 A	5 kA	100 A, K5 / RK5	18 kA	110 A, Class J
TF65-33	33 A	5 kA	100 A, K5 / RK5	18 kA	110 A, Class J
TF65-40	40 A	5 kA	100 A, K5 / RK5	18 kA	110 A, Class J
TF65-47	47 A	5 kA	125 A, K5 / RK5	18 kA	125 A, Class J
TF65-53	53 A	10 kA	125 A, K5 / RK5	18 kA	125 A, Class J
TF65-60	60 A	10 kA	150 A, K5 / RK5	18 kA	150 A, Class J
TF65-67	67 A	10 kA	150 A, K5 / RK5	18 kA	150 A, Class J

TF65 thermal overload relays – 22.0 to 67.0 A





Technical data

General technical data

Type	TF65	
Pollution degree	3	
Phase loss sensitive	Yes	
Ambient air temperature		
Operation	Open - compensated	-25 ... +60 °C
	Open	-25 ... +60 °C
Storage	-50 ... +80 °C	
Ambient air temperature compensation	Acc. to IEC/EN 60947-4-1	
Maximum operating altitude permissible	2000 m	
Resistance to shock acc. to IEC 60068-2-27	25g / 11 ms	
Resistance to vibrations acc. to IEC 60068-2-6	5g / 3 ... 150 Hz	
Mounting position	Position 1 to 6	
Mounting	Mount on the contactor and tighten the screws of the main circuit terminals or with single mounting kit on DIN rail (35 mm)	
Degree of protection	Housing	IP20
	Main circuit terminals	IP10





Electrical connection

Main circuit

Type	TF65	
Connecting capacity		
 Rigid	1 x or 2 x 1 x	2.5 ... 16 mm ² 2.5 ... 35 mm ²
 Flexible with ferrule	1 x or 2 x 1 x	2.5 ... 10 mm ² 2.5 ... 35 mm ²
 Flexible with insulated ferrule	1 x or 2 x 1 x	2.5 ... 10 mm ² ¹⁾ 2.5 ... 35 mm ²
 Flexible	1 x or 2 x 1 x	2.5 ... 16 mm ² 2.5 ... 35 mm ²
Stranded acc. to UL/CSA	1 x 2 x	AWG 12 ... 2 AWG 12 ... 6
Flexible acc. to UL/CSA	1 x 2 x	AWG 12 ... 2 AWG 12 ... 6
Stripping length	17 mm	
Tightening torque	4.0 - 4.5 Nm / 35 ... 40 lb.in	
Recommended screw driver	M6 (Pozidriv 2)	

¹⁾ Valid for products, produced from week 27, 2015.

Auxiliary circuit

Type	TF65	
Connecting capacity		
 Rigid	1 x or 2 x	0.75 ... 4 mm ²
 Flexible with ferrule	1 x or 2 x	0.75 ... 4 mm ²
 Flexible with insulated ferrule	1 x 2 x	0.75 ... 2.5 mm ² 0.75 ... 1.5 mm ²
 Flexible	1 x or 2 x	0.75 ... 1 mm ² or 1 ... 2.5 mm ² ²⁾
Stranded acc. to UL/CSA	1 x or 2 x	AWG 18 ... 12
Flexible acc. to UL/CSA	1 x or 2 x	AWG 18 ... 12
Stripping length	9 mm	
Tightening torque	1.1 ... 1.5 Nm / 9 ... 13 lb.in	
Recommended screw driver	M3 (Pozidriv 2)	

²⁾ Only connect two different "conductor/wire" cross-sections, if they are within the indicated ranges

TF96 thermal overload relays – 40.0 to 96.0 A

Ordering details



TF96

2CDC231005F0013



DB96

2CDC231001V0015



DB96 + TF96

2CDC231005V0015



KPR-101L

1SFC151224F0002

Description

The TF96 thermal overload relays are economic electromechanical protection devices for the main circuit. They offer reliable protection for motors in the event of overload or phase failure. The devices have trip class 10.

The thermal overload relays are three pole relays with bimetal tripping elements. The motor current flows through the bimetal tripping elements and heats them directly and indirectly. In case of an overload (over current), the bimetal elements bent as a result of the heating. This leads to a release of the relay and a change of the contacts switching position (95-96 / 97-98).

- Manual or automatic reset selectable
- Phase loss sensitive acc. to IEC/EN 60947-4-1
- TEST and STOP function – Trip indication on the front
- Temperature compensation
- Suitable for three- and single-phase applications
- With ATEX certification ¹⁾

Ordering details

Setting range	Short-circuit protective device	Trip class	Type	Order code	Weight (1 pc) kg
40.0 ... 51.0	125 A, gG Type Fuses	10	TF96-51	1SAZ911201R1001	0.620
48.0 ... 60.0	160 A, gG Type Fuses	10	TF96-60	1SAZ911201R1002	0.620
57.0 ... 68.0	160 A, gG Type Fuses	10	TF96-68	1SAZ911201R1003	0.620
65.0 ... 78.0	200 A, gG Type Fuses	10	TF96-78	1SAZ911201R1004	0.620
75.0 ... 87.0	200 A, gG Type Fuses	10	TF96-87	1SAZ911201R1005	0.620
84.0 ... 96.0	250 A, gG Type Fuses	10	TF96-96	1SAZ911201R1006	0.630

Ordering details accessories

Suitable for	Description	Type	Order code	Weight (1 pc) kg
TF96, EF96	Single mounting kit	DB96	1SAZ901901R1001	0.190
TF96	Reset push button ²⁾	KPR-101L	1SFA616162R1014	0.027

¹⁾ ATEX is valid for products, produced from week 26, 2015

²⁾ Note: for more information see catalog 1SFC151004C0201

Main dimensions mm, inches

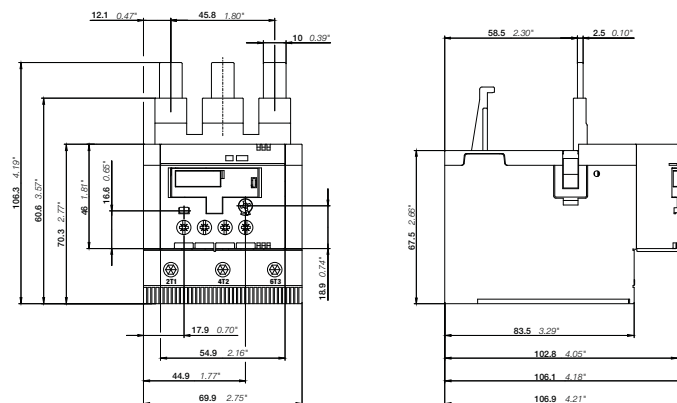

TF96

2CDC232005F0009

2CDC106064C0201

TF96 thermal overload relays – 40.0 to 96.0 A

Technical data

Main circuit – Utilization characteristics according to IEC/EN

Type	TF96
Standards	IEC/EN 60947-1, IEC/EN 60947-4-1, IEC/EN 60947-5-1
Rated operational voltage U_n	690 V AC
Rated frequency	50/60 Hz
Trip class	10
Number of poles	3
Duty time	100 %
Operating frequency without early tripping	Up to 15 operations/h, see "Technical diagram – Intermittent periodic duty"
Rated impulse withstand voltage U_{imp}	8 kV
Rated insulation voltage U_i	690 V

Auxiliary circuit according to IEC/EN

Type	TF96
Rated operational voltage U_n	600 V
Conventional free air thermal current I_{th}	N.C., 95-96 6 A N.O., 97-98 4 A
Rated frequency	DC, 50/60 Hz
Number of poles	1 N.O. + 1 N.C.
I_n / Rated operational current AC-15 acc. to IEC/EN 60947-5-1 for utilization category	
110-120 V	N.C., 95-96 3.00 A N.O., 97-98 0.75 A
220-230-240 V	N.C., 95-96 3.00 A N.O., 97-98 0.75 A
440 V	N.C., 95-96 0.75 A N.O., 97-98 0.75 A
480-500 V	N.C., 95-96 0.75 A N.O., 97-98 0.75 A
I_n / Rated operational current DC-13 acc. to IEC/EN 60947-5-1 for utilization category	
24 V	N.C., 95-96 1.25 A N.O., 97-98 1.25 A
110-120-125 V	N.C., 95-96 0.55 A N.O., 97-98 0.55 A
250 V	N.C., 95-96 0.27 A N.O., 97-98 0.27 A
Minimum switching capacity	17 V / 3 mA
Short-circuit protective device	N.C., 95-96 6 A, fuse type gG N.O., 97-98 4 A, fuse type gG
Rated impulse withstand voltage U_{imp}	6 kV
Rated insulation voltage U_i	690 V

Technical diagram – Intermittent periodic duty

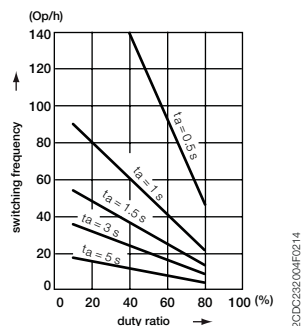

t_a : Motor starting time

TF96 thermal overload relays – 40.0 to 96.0 A

Technical data

Main circuit – Utilization characteristics according to UL/CSA

Type	TF96
Standards	UL 60947-1, UL 60947-4-1
Maximum operational voltage	600 V AC
Trip rating	125 % of FLA
Full load amps (FLA)	See table "Full load amps and short-circuit protective device"
Short-circuit rating RMS symmetrical	See table "Full load amps and short-circuit protective device"
Short-circuit protective device	See table "Full load amps and short-circuit protective device"

Auxiliary circuit according to UL/CSA

Type	TF96
Contact rating	N.C., 95-96 B600, Q600 N.O., 97-98 D300, Q600
Conventional thermal current	N.C., 95-96 6 A N.O., 97-98 4 A

Full load amps and short-circuit protective device

Type	Full load amps (FLA)	Short-circuit protective device		480 / 600 V AC	
		480 / 600 V AC Short circuit rating RMS symmetrical	Fuse type	480 / 600 V AC Short circuit rating RMS symmetrical	Fuse type
TF96-51	51 A	5 kA	150 A, K5 / RK5	18 kA	125 A, Class J
TF96-60	60 A	10 kA	150 A, K5 / RK5	18 kA	150 A, Class J
TF96-68	68 A	10 kA	150 A, K5 / RK5	18 kA	150 A, Class J
TF96-78	78 A	10 kA	175 A, K5 / RK5	18 kA	175 A, Class J
TF96-87	87 A	10 kA	200 A, K5 / RK5	18 kA	200 A, Class J
TF96-96	96 A	10 kA	250 A, K5 / RK5	18 kA	200 A, Class J

TF96 thermal overload relays – 40.0 to 96.0 A





Technical data

General technical data

Type	TF96	
Pollution degree	3	
Phase loss sensitive	Yes	
Ambient air temperature		
Operation	Open - compensated	-25 ... +60 °C
Storage	Open	-25 ... +60 °C
Storage		-50 ... +80 °C
Ambient air temperature compensation	Acc. to IEC/EN60947-4-1	
Maximum operating altitude permissible	2000 m	
Resistance to shock acc. to IEC 60068-2-27	25g / 11 ms	
Resistance to vibrations acc. to IEC 60068-2-6	5g / 3 ... 150 Hz	
Mounting position	Position 1 to 6	
Mounting	Mount on the contactor and tighten the screws of the main circuit terminals or with single mounting kit on DIN rail (35 mm)	
Degree of protection	Housing	IP20
	Main circuit terminals	IP10





Electrical connection

Main circuit

Type	TF96	
Connecting capacity		
 Rigid	1 x or 2 x 1 x	6 ... 35 mm ² 6 ... 50 mm ²
 Flexible with ferrule	1 x or 2 x 1 x	6 ... 35 mm ² 6 ... 50 mm ²
 Flexible with insulated ferrule	1 x or 2 x 1 x	6 ... 16 mm ² 6 ... 50 mm ²
 Flexible	1 x or 2 x 1 x	6 ... 35 mm ² 6 ... 50 mm ²
	Stranded acc. to UL/CSA	1 x AWG 8 ... 1 2 x AWG 8 ... 3
	Flexible acc. to UL/CSA	1 x AWG 8 ... 1 2 x AWG 8 ... 3
Stripping length	20 mm ¹⁾	
Tightening torque	6 ... 9 Nm / 53 ... 80 lb.in ¹⁾	
Recommended screw driver	M8 (Hexagon)	

1) Valid for products, produced from week 27, 2015

Auxiliary circuit

Type	TF96	
Connecting capacity		
 Rigid	1 x or 2 x	0.75 ... 4 mm ²
 Flexible with ferrule	1 x or 2 x	0.75 ... 4 mm ²
 Flexible with insulated ferrule	1 x 2 x	0.75 ... 2.5 mm ² 0.75 ... 1.5 mm ²
 Flexible	1 x or 2 x	0.75 ... 1 mm ² or 1 ... 2.5 mm ² ²⁾
	Stranded acc. to UL/CSA	1 x or 2 x AWG 18 ... 12
	Flexible acc. to UL/CSA	1 x or 2 x AWG 18 ... 12
Stripping length	9 mm	
Tightening torque	1.1 ... 1.5 Nm / 9 ... 13 lb.in	
Recommended screw driver	M3 (Pozidriv 2)	

²⁾ Only connect two different "conductor/wire" cross-sections, if they are within the indicated ranges

TF140DU thermal overload relays – 66 to 142 A

Ordering details



2CDC231012P0012

TF140DU



1SFC151224F0002

KPR-101L

Description

The TF140DU thermal overload relays are economic electromechanical protection devices for the main circuit. They offer reliable protection for motors in the event of overload or phase failure. The devices have trip class 10A.

The thermal overload relays are three pole relays with bimetal tripping elements. The motor current flows through the bimetal tripping elements and heats them directly and indirectly. In case of an overload (over current), the bimetal elements bent as a result of the heating. This leads to a release of the relay and a change of the contacts switching position (95-96 / 97-98).

- Manual or automatic reset selectable
- Phase loss sensitive acc. to IEC/EN 60947-4-1
- TEST and STOP function – Trip indication on the front
- Temperature compensation
- Suitable for three- and single-phase applications
- ATEX variants available

Ordering details

Setting range	Short-circuit protective device	Trip class	Type	Order code	Weight (1 pc) kg
A					
66 ... 90	200 A, fuse type gG	10A	TF140DU-90	1SAZ431201R1001	0.820
80 ... 110	224 A, fuse type gG	10A	TF140DU-110	1SAZ431201R1002	0.820
100 ... 135	224 A, fuse type gG	10A	TF140DU-135	1SAZ431201R1003	0.820
110 ... 142	250 A, fuse type gG	10A	TF140DU-142	1SAZ431201R1004	0.820
66 ... 90	200 A, fuse type gG	10A	TF140DU-90-V1000*	1SAZ431301R1001	0.820
80 ... 110	224 A, fuse type gG	10A	TF140DU-110-V1000*	1SAZ431301R1002	0.820
100 ... 135	224 A, fuse type gG	10A	TF140DU-135-V1000*	1SAZ431301R1003	0.820
110 ... 142	250 A, fuse type gG	10A	TF140DU-142-V1000*	1SAZ431301R1004	0.820

*Note: ATEX variant

Ordering details accessories

Suitable for	Description	Type	Order code	Weight (1 pc) kg
TF140DU	Reset push button*	KPR-101L	1SFA616162R1014	0.027

*Note: for more information see catalog 1SFC151004C0201

Main dimensions mm, inches

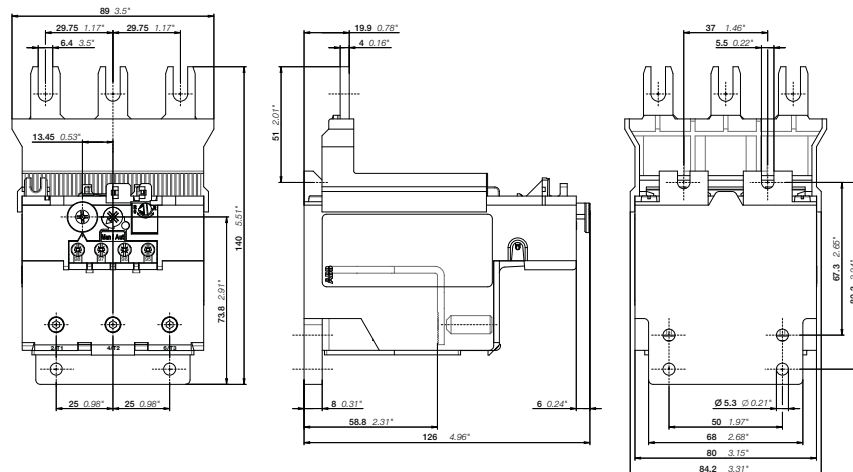

TF140DU

2CDC232008F0012

2CDC106054C0201

TF140DU thermal overload relays – 66 to 142 A

Technical data

Main circuit – Utilization characteristics according to IEC/EN

Type	TF140DU / TF140DU-V1000
Standards	IEC/EN 60947-1, IEC/EN 60947-4-1, IEC/EN 60947-5-1
Rated operational voltage U_n	690 V AC
Rated frequency	DC, 50/60 Hz
Frequency range	0 ... 400 Hz
Trip class	10A
Number of poles	3
Duty time	100 %
Operating frequency without early tripping	Up to 15 operations/h, see "Technical diagram – Intermittent periodic duty"
Rated impulse withstand voltage U_{imp}	8 kV
Rated insulation voltage U_i	690 V

Auxiliary circuit according to IEC/EN

Type	TF140DU / TF140DU-V1000
Rated operational voltage U_n	500 V AC, 440 V DC
Conventional free air thermal current I_{th}	N.C., 95-96 10 A N.O., 97-98 6 A
Rated frequency	DC, 50/60 Hz
Number of poles	1 N.O. + 1 N.C.
I_n / Rated operational current AC-15 acc. to IEC/EN 60947-5-1 for utilization category	
110-120 V	N.C., 95-96 3.00 A N.O., 97-98 1.50 A
220-230-240 V	N.C., 95-96 1.50 A N.O., 97-98 1.50 A
440 V	N.C., 95-96 1.00 A N.O., 97-98 1.00 A
480-500 V	N.C., 95-96 1.00 A N.O., 97-98 1.00 A
I_n / Rated operational current DC-13 acc. to IEC/EN 60947-5-1 for utilization category	
24 V	N.C., 95-96 1.25 A N.O., 97-98 1.25 A
60 V	N.C., 95-96 0.25 A N.O., 97-98 0.25 A
110-120-125 V	N.C., 95-96 0.25 A N.O., 97-98 0.25 A
250 V	N.C., 95-96 0.12 A N.O., 97-98 0.04 A
Minimum switching capacity	17 V / 3 mA
Short-circuit protective device	N.C., 95-96 10 A, fuse type gG N.O., 97-98 6 A, fuse type gG
Rated impulse withstand voltage U_{imp}	6 kV
Rated insulation voltage U_i	690 V

Technical diagram – Intermittent periodic duty

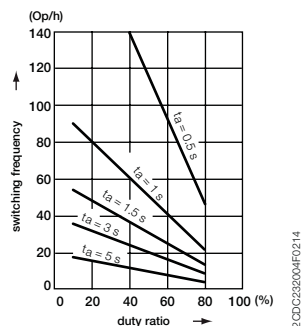

t_s : Motor starting time

TF140DU thermal overload relays – 66 to 142 A

Technical data

Main circuit – Utilization characteristics according to UL/CSA

Type	TF140DU / TF140DU-V1000
Standards	UL 508, CSA 22.2 No. 14, UL 60947-4-1A
Maximum operational voltage	600 V AC
Trip rating	125 % of FLA
Full load amps (FLA)	See table "Full load amps and short-circuit protective device"
Short-circuit rating RMS symmetrical	See table "Full load amps and short-circuit protective device"
Short-circuit protective device	See table "Full load amps and short-circuit protective device"

Auxiliary circuit according to UL/CSA

Type	TF140DU / TF140DU-V1000	
Contact rating	N.C., 95-96	B600
	N.O., 97-98	C300
Conventional thermal current	N.C./N.O.	10 A / 6 A

Full load amps and short-circuit protective device

Type	Full load amps (FLA)	Short-circuit protective device					
		480 / 600 V AC		480 / 600 V AC		480 / 600 V AC	
		Short circuit rating RMS symmetrical	Fuse type	Short circuit rating RMS symmetrical	Fuse type	Short circuit rating RMS symmetrical	Listed circuit breaker
TF140DU-90 / TF140DU-90-V1000	90 A	10 kA	250 A, K5 / RK5	100 kA	250 A, Class J	100 kA	250 A
TF140DU-110 / TF140DU-110-V1000	110 A	10 kA	250 A, K5 / RK5	100 kA	250 A, Class J	100 kA	250 A
TF140DU-135 / TF140DU-135-V1000	135 A	10 kA	250 A, K5 / RK5	100 kA	250 A, Class J	100 kA	250 A
TF140DU-142 / TF140DU-142-V1000	142 A	10 kA	250 A, K5 / RK5	100 kA	250 A, Class J	100 kA	250 A

7

TF140DU thermal overload relays – 66 to 142 A



Technical data

General technical data





Type	TF140DU / TF140DU-V1000	
Pollution degree	3	
Phase loss sensitive	Yes	
Ambient air temperature		
Operation	Open - compensated	-25 ... +55 °C
	Open	-25 ... +55 °C
Storage		-40 ... +70 °C
Ambient air temperature compensation	Acc. to IEC/EN 60947-4-1	
Maximum operating altitude permissible	2000 m	
Resistance to shock acc. to IEC 60068-2-27	12g / 11 ms	
Mounting position	Position 1-5	
Mounting	Mount on the contactor and tighten the screws of the main circuit terminals	
Degree of protection	Housing	IP20
	Main circuit terminals	IP00

Electrical connection

Main circuit

Type	TF140DU / TF140DU-V1000		
Connecting capacity			
 Rigid	1 x	16 ... 70 mm ²	
	2 x	-	
 Flexible	1 x	16 ... 70 mm ²	
	2 x	-	
	Stranded acc. to UL/CSA	1 x or 2 x	AWG 6-2/0
	Flexible acc. to UL/CSA	1 x or 2 x	AWG 6-2/0
Stripping length	25 mm		
Tightening torque	8 ... 10 Nm / 77 ... 88 lb.in		
Recommended screw driver	M8 (Hexagon)		

Auxiliary circuit

Type	TF140DU / TF140DU-V1000		
Connecting capacity			
 Rigid	1 x or 2 x	0.75 ... 4 mm ²	
 Flexible with ferrule	1 x or 2 x	0.75 ... 2.5 mm ²	
 Flexible with insulated ferrule	1 x or 2 x	0.75 ... 2.5 mm ²	
 Flexible	1 x or 2 x	0.75 ... 2.5 mm ²	
	Stranded acc. to UL/CSA	1 x or 2 x	AWG 18-14
	Flexible acc. to UL/CSA	1 x or 2 x	AWG 18-14
Stripping length	9 mm		
Tightening torque	0.8 ... 1.3 Nm / 12 lb.in		
Recommended screw driver	M3.5 (Pozidriv 2)		

TA200DU thermal overload relays – 66 to 200 A

Ordering details

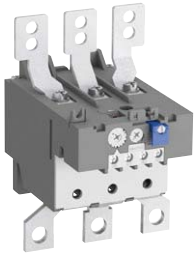

2CDC231016F0013

TA200DU



1SFC151224F0002

KPR-101L

Description

The TA200DU thermal overload relays are economic electromechanical protection devices for the main circuit. They offer reliable protection for motors in the event of overload or phase failure. The devices have trip class 10A.

The thermal overload relays are three pole relays with bimetal tripping elements. The motor current flows through the bimetal tripping elements and heats them directly and indirectly. In case of an overload (over current), the bimetal elements bent as a result of the heating. This leads to a release of the relay and a change of the contacts switching position (95-96 / 97-98).

- Manual or automatic reset selectable
- Phase loss sensitive acc. to IEC/EN 60947-4-1
- TEST and STOP function – Trip indication on the front
- Temperature compensation
- Suitable for three- and single-phase applications
- ATEX variants available

Ordering details

Setting range	Short-circuit protective device	Trip class	Type	Order code	Weight (1 pc) kg
A					
66 ... 90	200 A, fuse type gG / 125 A aM	10A	TA200DU-90	1SAZ421201R1001	0.755
80 ... 110	224 A, fuse type gG / 160 A aM	10A	TA200DU-110	1SAZ421201R1002	0.760
100 ... 135	224 A, fuse type gG / 200 A aM	10A	TA200DU-135	1SAZ421201R1003	0.760
110 ... 150	250 A, fuse type gG / 200 A aM	10A	TA200DU-150	1SAZ421201R1004	0.760
130 ... 175	315 A, fuse type gG / 250 A aM	10A	TA200DU-175	1SAZ421201R1005	0.770
150 ... 200	315 A, fuse type gG / 250 A aM	10A	TA200DU-200	1SAZ421201R1006	0.785
66 ... 90	200 A, fuse type gG / 125 A aM	10A	TA200DU-90-V1000 ¹⁾	1SAZ421301R1001	0.755
80 ... 110	224 A, fuse type gG / 160 A aM	10A	TA200DU-110-V1000 ¹⁾	1SAZ421301R1002	0.760
100 ... 135	224 A, fuse type gG / 200 A aM	10A	TA200DU-135-V1000 ¹⁾	1SAZ421301R1003	0.760
110 ... 150	250 A, fuse type gG / 200 A aM	10A	TA200DU-150-V1000 ¹⁾	1SAZ421301R1004	0.760
130 ... 175	315 A, fuse type gG / 250 A aM	10A	TA200DU-175-V1000 ¹⁾	1SAZ421301R1005	0.770
150 ... 200	315 A, fuse type gG / 250 A aM	10A	TA200DU-200-V1000 ¹⁾	1SAZ421301R1006	0.785

¹⁾ ATEX variant

Ordering details accessories

Suitable for	Description	Type	Order code	Weight (1 pc) kg
TA200DU	Terminal shroud	LT200/A	1SAZ401901R1001	0.090
TA200DU	Single mounting kit	DB200	1SAZ401110R0001	0.225
TA200DU	Reset push button*	KPR-101L	1SFA616162R1014	0.027

*Note: for more information see catalog 1SFC151004C0201

Main dimensions mm, inches

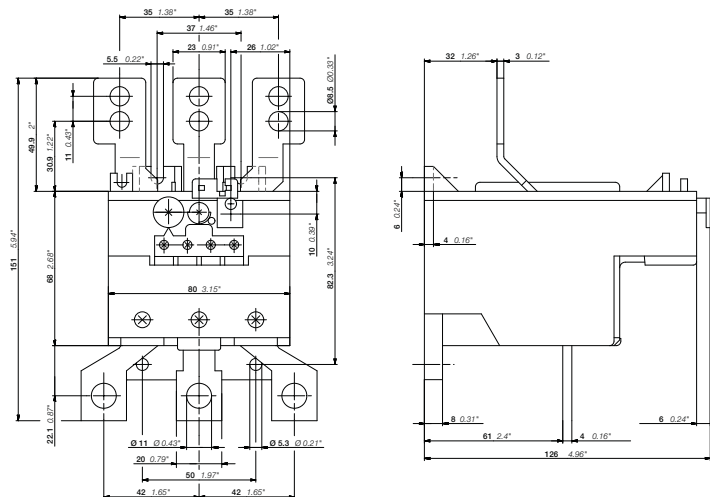

TA200DU

2CDC23021 F0011

2CDC106038C0201

TA200DU thermal overload relays – 66 to 200 A

Technical data

Main circuit – Utilization characteristics according to IEC/EN

Type	TA200DU / TA200DU-V1000
Standards	IEC/EN 60947-1, IEC/EN 60947-4-1
Rated operational voltage U_n	690 V AC
Rated frequency	DC, 50/60 Hz
Frequency range	0 ... 400 Hz
Trip class	10A
Number of poles	3
Duty time	100 %
Operating frequency without early tripping	Up to 15 operations/h, see "Technical diagram – Intermittent periodic duty"
Rated impulse withstand voltage U_{imp}	6 kV
Rated insulation voltage U_i	690 V AC

Auxiliary circuit according to IEC/EN

Type	TA200DU / TA200DU-V1000
Rated operational voltage U_n	500 V AC, 440 V DC
Conventional free air thermal current I_{th}	N.C., 95-96 10 A N.O., 97-98 6 A
Rated frequency	DC, 50/60 Hz
Number of poles	1 N.O. + 1 N.C.
I_n / Rated operational current AC-15 acc. to IEC/EN 60947-5-1 for utilization category	
110-120 V	N.C., 95-96 3.00 A N.O., 97-98 1.50 A
220-230-240 V	N.C., 95-96 3.00 A N.O., 97-98 1.50 A
440 V	N.C., 95-96 1.00 A N.O., 97-98 1.00 A
480-500 V	N.C., 95-96 1.00 A N.O., 97-98 1.00 A
I_n / Rated operational current DC-13 acc. to IEC/EN 60947-5-1 for utilization category	
24 V	N.C., 95-96 1.25 A N.O., 97-98 1.25 A
60 V	N.C., 95-96 0.25 A N.O., 97-98 0.25 A
110-120-125 V	N.C., 95-96 0.25 A N.O., 97-98 0.25 A
250 V	N.C., 95-96 0.12 A N.O., 97-98 0.04 A
Minimum switching capacity	17 V / 3 mA
Short-circuit protective device	N.C., 95-96 10 A, fuse type gG N.O., 97-98 6 A, fuse type gG
Rated impulse withstand voltage U_{imp}	6 kV
Rated insulation voltage U_i	690 V

Technical diagram – Intermittent periodic duty

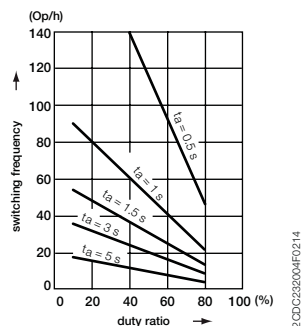

t_s : Motor starting time

TA200DU thermal overload relays – 66 to 200 A

Technical data

Main circuit – Utilization characteristics according to UL/CSA

Type	TA200DU / TA200DU-V1000
Standards	UL 508, CSA 22.2 No. 14
Maximum operational voltage	600 V AC
Trip rating	125 % of FLA
Full load amps (FLA)	See table "Full load amps and short-circuit protective device"
Short-circuit rating RMS symmetrical	See table "Full load amps and short-circuit protective device"
Short-circuit protective device	See table "Full load amps and short-circuit protective device"

Auxiliary circuit according to UL/CSA

Type	TA200DU / TA200DU-V1000	
Contact rating	N.C., 95-96	C600
	N.O., 97-98	B600
Conventional thermal current	5 A	

Full load amps and short-circuit protective device

Type	Full load amps (FLA)	Short-circuit protective device						
		480 / 600 V AC		225 A		100 kA		250 A
		Short circuit rating RMS symmetrical	Fuse type	Listed circuit breaker	Short circuit rating RMS symmetrical	Fuse type	Short circuit rating RMS symmetrical	Listed circuit breaker
TA200DU-90 / TA200DU-90-V1000	90 A	10 kA	250 A, K5 / RK5	225 A	100 kA	250 A, Class J	100 kA	250 A
TA200DU-110 / TA200DU-110-V1000	110 A	10 kA	250 A, K5 / RK5	225 A	100 kA	250 A, Class J	100 kA	250 A
TA200DU-135 / TA200DU-135-V1000	135 A	10 kA	300 A, K5 / RK5	225 A	100 kA	250 A, Class J	100 kA	250 A
TA200DU-150 / TA200DU-150-V1000	150 A	10 kA	300 A, K5 / RK5	225 A	100 kA	250 A, Class J	100 kA	250 A
TA200DU-175 / TA200DU-175-V1000	175 A	10 kA	300 A, K5 / RK5	225 A	100 kA	300 A, Class J	100 kA	300 A
TA200DU-200 / TA200DU-200-V1000	200 A	10 kA	400 A, K5 / RK5	400 A	100 kA	400 A, Class J	100 kA	400 A

7

TA200DU thermal overload relays – 66 to 200 A



Technical data

General technical data





Type	TA200DU / TA200DU-V1000	
Pollution degree	3	
Phase loss sensitive	Yes	
Ambient air temperature		
Operation	Open - compensated	-25 ... +55 °C
	Open	-25 ... +55 °C
Storage		-40 ... +70 °C
Ambient air temperature compensation	Acc. to IEC/EN60947-4-1	
Maximum operating altitude permissible	2000 m	
Resistance to shock acc. to IEC 60068-2-27	12g / 15 ms	
Mounting position	Position 1-6	
Mounting	Mount on the contactor and tighten the screws of the main circuit terminals or with single mounting kit	
Degree of protection	Housing	IP20
	Main circuit terminals	IP00

Electrical connection

Main circuit

Type	TA200DU / TA200DU-V1000	
Connecting capacity		
 Rigid	1 x	25 ... 120 mm ²
 Flexible	1 x	25 ... 120 mm ²
	Stranded acc. to UL/CSA	1 x AWG 4 ... 0000
	Flexible acc. to UL/CSA	1 x AWG 4 ... 0000
	Lugs	L > 10 mm
Tightening torque	25 Nm / 220 lb.in	
Recommended screw driver	Open bars	

Auxiliary circuit

Type	TA200DU / TA200DU-V1000	
Connecting capacity		
 Rigid	1 x or 2 x	0.75 ... 4 mm ²
 Flexible with ferrule	1 x or 2 x	0.75 ... 2.5 mm ²
 Flexible with insulated ferrule	1 x or 2 x	0.75 ... 2.5 mm ²
 Flexible	1 x or 2 x	0.75 ... 2.5 mm ²
	Stranded acc. to UL/CSA	1 x or 2 x AWG 18 ... 14
	Flexible acc. to UL/CSA	1 x or 2 x AWG 18 ... 14
Stripping length	9 mm	
Tightening torque	0.8 ... 1.3 Nm / 12 lb.in	
Recommended screw driver	M3.5 (Pozidriv 2)	

E16DU, EF19, EF45 electronic overload relays – 0.10 to 45.0 A

Ordering details



2CDC231001R0007

E16DU-1.0



1SBC101147FC010

EF19-18.9



1SBC101148F0010

EF45-30

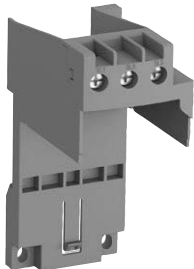

2CDC231024V0013

DB19EF



2CDC231002V0014

DB45EF



1SFC151224R0002

KPR-101L

Description

The E16DU, EF19 and EF45 are self-supplied electronic overload relays, which means no extra external supply is needed. It offers reliable protection for motors in the event of overload or phase failure. Easy to use like a thermal overload relay and compatible with standard motor applications, the electronic overload relay is convincing, above all, due to its wide setting range, high accuracy, high operational temperature range and the possibility to select a trip class (10E, 20E, 30E). Further features are the temperature compensation, trip contact (N.C.), signal contact (N.O.), automatic or manual reset selectable, trip-free mechanism, STOP and TEST function and a trip indication. The overload relays are connected directly to the contactors. The EF19 and EF45 have ATEX certification ¹⁾.

Ordering details

Setting range	Short-circuit protective device	Trip class	Type	Order code	Weight (1 pc) kg
A					
E16DU electronic overload relays					
0.10 ... 0.32	1 A, fuse type gG	10E, 20E, 30E	E16DU-0.32	1SAX111001R1101	0.150
0.30 ... 1.00	4 A, fuse type gG	10E, 20E, 30E	E16DU-1.0	1SAX111001R1102	0.150
0.80 ... 2.70	10 A, fuse type gG	10E, 20E, 30E	E16DU-2.7	1SAX111001R1103	0.150
2.00 ... 6.30	20 A, fuse type gG	10E, 20E, 30E	E16DU-6.3	1SAX111001R1104	0.150
5.70 ... 18.9	50 A, fuse type gG	10E, 20E, 30E	E16DU-18.9	1SAX111001R1105	0.150

EF19 electronic overload relays ¹⁾

0.10 ... 0.32	1 A, fuse type gG	10E, 20E, 30E	EF19-0.32	1SAX121001R1101	0.158
0.30 ... 1.00	4 A, fuse type gG	10E, 20E, 30E	EF19-1.0	1SAX121001R1102	0.158
0.80 ... 2.70	10 A, fuse type gG	10E, 20E, 30E	EF19-2.7	1SAX121001R1103	0.158
1.90 ... 6.30	20 A, fuse type gG	10E, 20E, 30E	EF19-6.3	1SAX121001R1104	0.158
5.70 ... 18.9	50 A, fuse type gG	10E, 20E, 30E	EF19-18.9	1SAX121001R1105	0.158

EF45 electronic overload relays ¹⁾

9.00 ... 30.0	160 A, fuse type gG	10E, 20E, 30E	EF45-30	1SAX221001R1101	0.362
15.0 ... 45.0	160 A, fuse type gG	10E, 20E, 30E	EF45-45	1SAX221001R1102	0.362

¹⁾ ATEX is valid for products, produced from week 42, 2014.

Ordering details accessories

Suitable for	Description	Type	Order code	Weight (1 pc) kg
E16DU	Single mounting kit	DB16E	1SAX101110R0001	0.035
EF19	Single mounting kit	DB19EF	1SAX101910R1001	0.046
EF45	Single mounting kit	DB45EF	1SAX201910R0001	0.100
E16DU, EF19, EF45	Reset push button ²⁾	KPR-101L	1SFA616162R1014	0.019

²⁾ Note: for more information see catalog 1SFC151004C0201

Main dimensions mm, inches

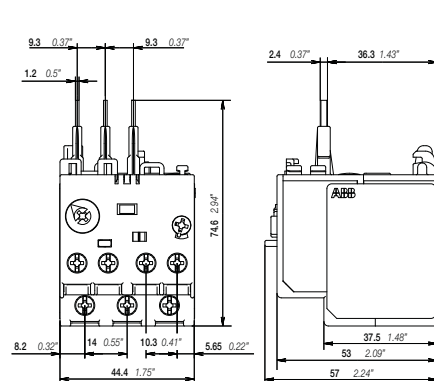

E16DU

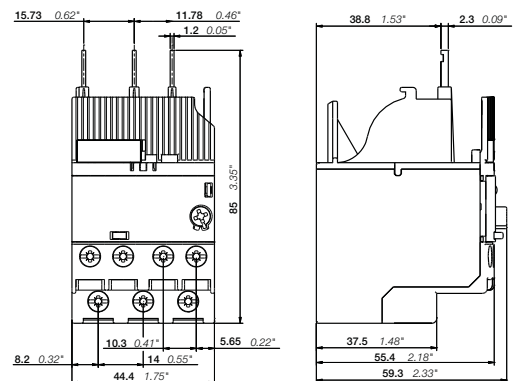

EF19

E16DU, EF19, EF45 electronic overload relays – 0.10 to 45.0 A

Technical data

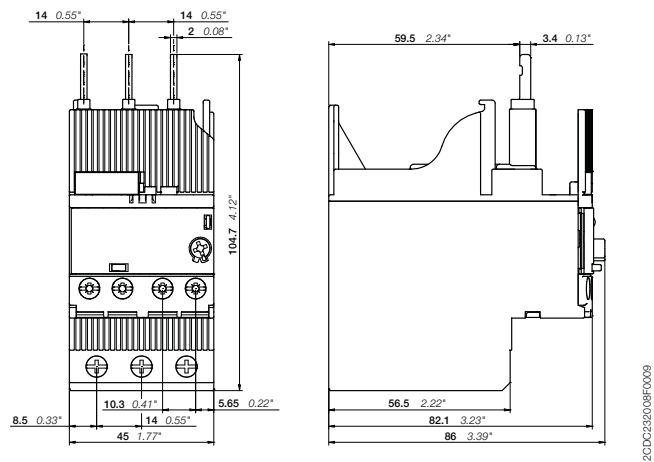

EF45

Main circuit – Utilization characteristics according to IEC/EN

Type	E16DU	EF19	EF45
Standards	IEC/EN 60947-1, IEC/EN 60947-4-1, IEC/EN 60947-5-1		
Rated operational voltage U_e	690 V AC		
Rated frequency	50/60 Hz – not suitable for DC applications		
Trip class	10E, 20E, 30E, selectable		
Number of poles	3		
Duty time	100 %		
Operating frequency without early tripping	Up to 15 operations/h, see "Technical diagram – Intermittent periodic duty"		
Rated impulse withstand voltage U_{imp}	6 kV		
Rated insulation voltage U_i	690 V AC		

Auxiliary circuit according to IEC/EN

Type	E16DU	EF19	EF45
Rated operational voltage U_e	600 V AC / DC		
Conventional free air thermal current I_{th}	6 A		
Rated frequency	DC, 50/60 Hz		
Number of poles	1 N.C. + 1 N.O.		
I_e / Rated operational current AC-15 acc. to IEC/EN 60947-5-1 for utilization category			
110-120 V	50/60 Hz	3.00 A	
220-230-240 V	50/60 Hz	3.00 A	
440 V	50/60 Hz	1.10 A	
480-500 V	50/60 Hz	0.75 A	
I_e / Rated operational current DC-13 acc. to IEC/EN 60947-5-1 for utilization category			
24 V		1.50 A	
60 V		0.55 A	
110-120-125 V		0.55 A	
250 V		0.27 A	
Minimum switching capacity	12 V / 3 mA		
Short-circuit protective devices	6 A, fuse type gG		
Rated impulse withstand voltage U_{imp}	6 kV		
Rated insulation voltage U_i	690 V		

E16DU, EF19, EF45 electronic overload relays – 0.10 to 45.0 A

Technical data

Technical diagram – Intermittent periodic duty

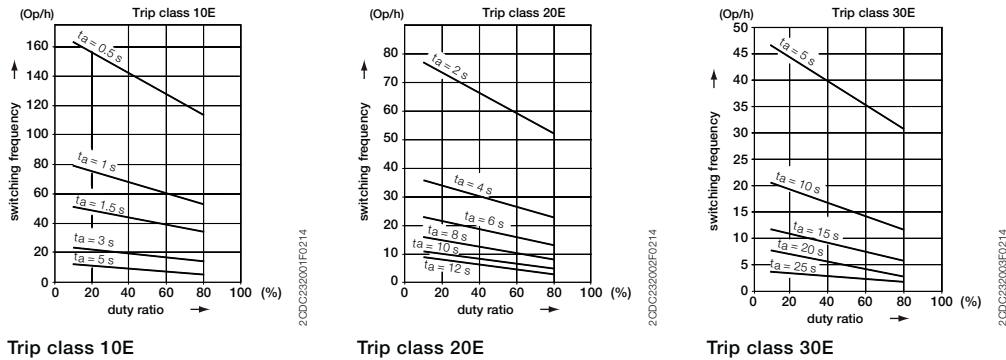

Main circuit – Utilization characteristics according to UL/CSA

Type	E16DU	EF19	EF45
Standards	UL 508, CSA 22.2 No. 14		
Maximum operational voltage	600 V AC		
Trip rating	125 % of FLA		
Full load amps (FLA)	See table "Full load amps and short-circuit protective device"		
Short-circuit rating RMS symmetrical	See table "Full load amps and short-circuit protective device"		
Short-circuit protective device	See table "Full load amps and short-circuit protective device"		

Auxiliary circuit according to UL/CSA

Type	E16DU	EF19	EF45
Contact rating	N.C., 95-96 N.O., 97-98	B600, Q300 B600, Q300	B600, Q600 B600, Q600
Conventional free-air thermal current	6 A		

Full load amps and short-circuit protective device

Type	Full load amps (FLA)	Short-circuit protective device					
		480 V AC		600 V AC		600 V AC	
		SCCR	Fuse type	SCCR	Fuse type	SCCR	Fuse type
E16DU-0.32	0.32 A	50 kA	2 A, Class J	5 kA	2 A, K5 / RK5	100 kA	2 A, Class J
E16DU-1.0	1.00 A	50 kA	2 A, K5 / RK5	5 kA	2 A, K5 / RK5	100 kA	2 A, Class J
E16DU-2.7	2.70 A	50 kA	4 A, K5 / RK5	5 kA	4 A, K5 / RK5	100 kA	4 A, Class J
E16DU-6.3	6.30 A	50 kA	15 A, K5 / RK5	5 kA	15 A, K5 / RK5	100 kA	15 A, Class J
E16DU-18.9	18.90 A	50 kA	30 A, K5 / RK5	5 kA	30 A, K5 / RK5	100 kA	30 A, Class J

Type	Full load amps (FLA)	Short-circuit protective device					
		480 V AC		600 V AC		600 V AC	
		SCCR	Fuse type	SCCR	Fuse type	SCCR	Fuse type
EF19-0.32	0.32 A	50 kA	2 A, Class J	5 kA	2 A, K5 / RK5	100 kA	2 A, Class J
EF19-1.0	1.00 A	50 kA	2 A, K5 / RK5	5 kA	2 A, K5 / RK5	100 kA	2 A, Class J
EF19-2.7	2.70 A	50 kA	4 A, K5 / RK5	5 kA	4 A, K5 / RK5	100 kA	4 A, Class J
EF19-6.3	6.30 A	50 kA	15 A, K5 / RK5	5 kA	15 A, K5 / RK5	100 kA	15 A, Class J
EF19-18.9	18.90 A	50 kA	30 A, K5 / RK5	5 kA	30 A, K5 / RK5	100 kA	30 A, Class J

Type	Full load amps (FLA)	Short-circuit protective device					
		480 V AC		600 V AC		600 V AC	
		SCCR	Fuse type	SCCR	Fuse type	SCCR	Fuse type
EF45-30	30 A	18 kA	150 A, K5 / RK5	18 kA	150 A, K5 / RK5	100 kA	150 A, Class J
EF45-45	45 A	18 kA	200 A, K5 / RK5	18 kA	200 A, K5 / RK5	100 kA	200 A, Class J

E16DU, EF19, EF45 electronic overload relays – 0.10 to 45.0 A



Technical data

General data





Type	E16DU	EF19	EF45
Pollution degree	3		
Phase loss sensitive	Yes		
Ambient air temperature			
Operation	Open - compensated		
Storage			
Ambient air temperature compensation	Acc. to IEC/EN60947-4-1		
Maximum operating altitude permissible	2000 m		
Resistance to shock acc. to IEC 60068-2-27	15g / 11 ms pulse	25g / 11 ms pulse	
Resistance to vibrations acc. to IEC 60068-2-6	5g / 3 ... 150 Hz	3g / 3 ... 150 Hz	
Mounting position	Position 1-6		
Mounting	Mount on the contactor and tighten the screws of the main circuit terminals		
Degree of protection	Housing		
	Main circuit terminals		
	IP20		
	IP20		

Electrical connection

Main circuit

Type	E16DU	EF19	EF45
Connecting capacity			
 Rigid	1 or 2 x 1 ... 4 mm ²	1 ... 4 mm ²	2.5 ... 16 mm ²
 Flexible with insulated ferrule	1 or 2 x 0.75 ... 2.5 mm ²	0.75 ... 2.5 mm ²	2.5 ... 10 mm ²
Stranded acc. to UL/CSA	1 or 2 x AWG 16-10	AWG 16-10	AWG 14-6
Flexible acc. to UL/CSA	1 or 2 x AWG 16-10	AWG 16-10	AWG 14-6
Stripping length	9 mm	9 mm	13 mm
Tightening torque	0.8 ... 1.5 Nm / 7 ... 13 lb.in	0.8 ... 1.5 Nm / 7 ... 13 lb.in	2.3 ... 2.6 Nm / 20 ... 22 lb.in
Recommended screw driver	M3.5 (Pozidriv 2)	M3.5 (Pozidriv 2)	M3.5 (Pozidriv 2)

Auxiliary circuit

Type	E16DU	EF19	EF45
Connecting capacity			
 Rigid	1 or 2 x 1 ... 4 mm ²	1 ... 4 mm ²	1 ... 4 mm ²
 Flexible with ferrule	1 or 2 x 0.75 ... 2.5 mm ²	0.75 ... 2.5 mm ²	0.75 ... 2.5 mm ²
 Flexible with insulated ferrule	1 or 2 x 0.75 ... 2.5 mm ²	0.75 ... 2.5 mm ²	0.75 ... 2.5 mm ²
 Flexible	1 or 2 x 0.75 ... 2.5 mm ²	0.75 ... 2.5 mm ²	0.75 ... 2.5 mm ²
Stranded acc. to UL/CSA	1 or 2 x AWG 16-10	AWG 18-10	AWG 18-10
Flexible acc. to UL/CSA	1 or 2 x AWG 16-10	AWG 18-10	AWG 18-10
Stripping length	9 mm	9 mm	9 mm
Tightening torque	0.8 ... 1.2 Nm / 7 ... 11 lb.in	0.8 ... 1.2 Nm / 7 ... 11 lb.in	0.8 ... 1.2 Nm / 7 ... 11 lb.in
Recommended screw driver	M3 (Pozidriv 2)	M3 (Pozidriv 2)	M3 (Pozidriv 2)

EF65, EF96, EF146 electronic overload relays – 20 to 150 A

Ordering details



EF65-70

2CDC231001F0012



EF96-100

2CDC231002F0012



EF146-150

2CDC231003F0012



DB96

2CDC231001V0015



DB96 + EF96

2CDC231002V0015



KPR-101L

1SFC15124F0002

Description

The EF65, EF96 and EF146 are self-supplied electronic overload relays, which means no extra external supply is needed. It offers reliable protection for motors in the event of overload or phase failure. Easy to use like a thermal overload relay and compatible with standard motor applications, the electronic overload relay is convincing, above all, due to its wide setting range, high accuracy, high operational temperature range and the possibility to select a trip class (10E, 20E, 30E). Further features are the temperature compensation, trip contact (N.C.), signal contact (N.O.), automatic or manual reset selectable, trip-free mechanism, STOP and TEST function and a trip indication. The overload relays are connected directly to the contactors. The EF65, EF96 and EF146 have ATEX certification ¹⁾.

Ordering details

Setting range	Short-circuit protective device	Trip class	Type	Order code	Weight (1 pc) kg
A					
20 ... 56	160 A, fuse type gG	10E, 20E, 30E	EF65-56	1SAX331001R1102	0.821
25 ... 70	160 A, fuse type gG	10E, 20E, 30E	EF65-70	1SAX331001R1101	0.821
36 ... 100	200 A, fuse type gG	10E, 20E, 30E	EF96-100	1SAX341001R1101	0.802
54 ... 150	315 A, fuse type gG	10E, 20E, 30E	EF146-150	1SAX351001R1101	0.879

¹⁾ ATEX is valid for products, produced from week 42, 2014. ATEX certification is valid for EF65-56, produced from week 47, 2015.

Ordering details accessories

Suitable for	Description	Type	Order code	Weight (1 pc) kg
EF96, TF96	Single mounting kit	DB96	1SAZ901901R1001	0.190
EF65, EF96, EF146	Reset push button ²⁾	KPR-101L	1SFA616162R1014	0.019

²⁾ Note: for more information see catalog 1SFC151004C0201

Main dimensions mm, inches

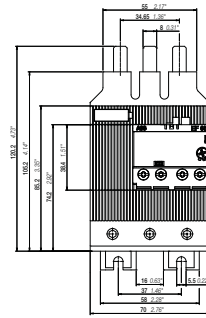

EF65-56 / EF65-70

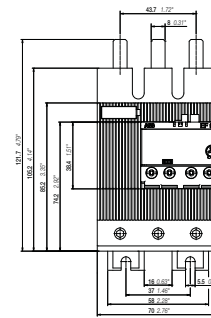
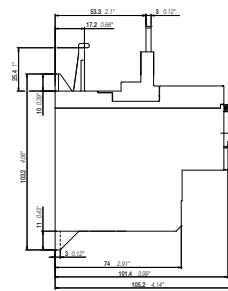

EF96-100

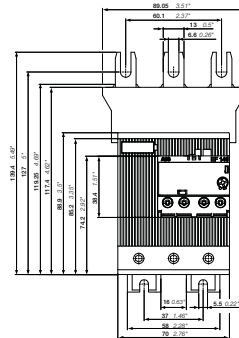

EF146-150

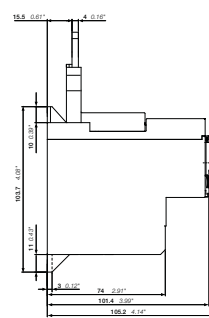

EF65, EF96, EF146 electronic overload relays – 20 to 150 A

Technical data

Main circuit – Utilization characteristics according to IEC/EN

Type	EF65, EF96, EF146
Standards	IEC/EN 60947-1, IEC/EN 60947-4-1, IEC/EN 60947-5-1
Rated operational voltage U_n	1000 V AC
Rated frequency	50/60 Hz – not suitable for DC applications
Trip class	10E, 20E, 30E, selectable
Number of poles	3
Duty time	100 %
Operating frequency without early tripping	Up to 15 operations/h, see "Technical diagram – Intermittent periodic duty"
Rated impulse withstand voltage U_{imp}	8 kV
Rated insulation voltage U_i	1000 V

Auxiliary circuit according to IEC/EN

Type	EF65, EF96, EF146
Rated operational voltage U_n	600 V AC / DC
Conventional free air thermal current I_{th}	6 A
Rated frequency	DC, 50/60 Hz
Number of poles	1 N.C. + 1 N.O.
I_n / Rated operational current AC-15 acc. to IEC/EN 60947-5-1 for utilization category	
110-120 V	50/60 Hz 3.00 A
220-230-240 V	50/60 Hz 3.00 A
400 V	50/60 Hz 1.10 A
480-500 V	50/60 Hz 0.75 A
I_n / Rated operational current DC-13 acc. to IEC/EN 60947-5-1 for utilization category	
24 V	1.50 A
60 V	0.55 A
110-120-125 V	0.55 A
250 V	0.27 A
Minimum switching capacity	12 V / 3 mA
Short-circuit protective device	6 A, fuse type gG
Rated impulse withstand voltage U_{imp}	6 kV
Rated insulation voltage U_i	690 V

Technical diagram – Intermittent periodic duty

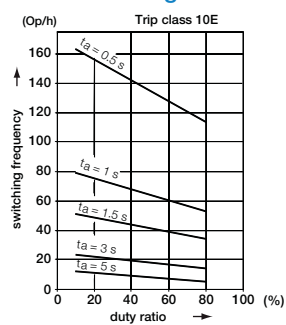

Trip class 10E

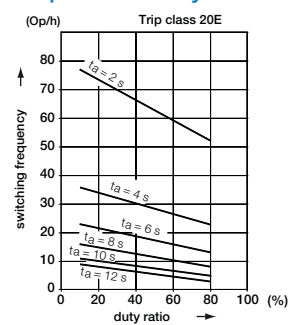

Trip class 20E

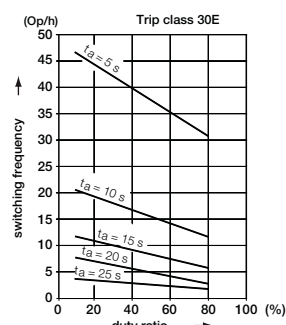

Trip class 30E

EF65, EF96, EF146 electronic overload relays – 20 to 150 A

Technical data

Main circuit – Utilization characteristics according to UL/CSA

Type	EF65, EF96, EF146
Standards	UL 508, CSA 22.2 No. 14, UL 60947-4-1A
Maximum operational voltage	600 V AC
Trip rating	125 % of FLA
Full load amps (FLA)	See table "Full load amps and short-circuit protective device"
Short-circuit rating RMS symmetrical	See table "Full load amps and short-circuit protective device"
Short-circuit protective device	See table "Full load amps and short-circuit protective device"

Auxiliary circuit according to UL/CSA

Type	EF65, EF96, EF146	
Contact rating	N.C., 95-96	B600, Q600
	N.O., 97-98	B600, Q600
Conventional thermal current	6 A	

Full load amps and short-circuit protective device

Type	Full load amps (FLA)	Short-circuit protective device					
		480 V AC		600 V AC			
		SCCR	Fuse type	SCCR	Fuse type	SCCR	Fuse type
EF65-56	56 A	10 kA	150 A, R5/RK5	10kA	150 A, R5/RK5	100 kA	175 A, J
EF65-70	70 A	10 kA	150 A, R5/RK5	10kA	150 A, R5/RK5	100 kA	175 A, J
EF96-100	100 A	10 kA	200 A, R5/RK5	10kA	200 A, R5/RK5	100 kA	225 A, J
EF146-150	150 A	10 kA	250 A, R5/RK5	10kA	250 A, R5/RK5	100 kA	350 A, J

EF65, EF96, EF146 electronic overload relays – 20 to 150 A



Technical data

General data





Type	EF65, EF96, EF146	
Pollution degree	3	
Phase loss sensitive	Yes	
Ambient air temperature		
Operation	Open - compensated	-25 ... +70 °C
Storage		-50 ... +85 °C
Ambient air temperature compensation	Acc. to IEC/EN 60947-4-1	
Maximum operating altitude permissible	2000 m	
Resistance to shock acc. to IEC 60068-2-27	15g / 11 ms	
Resistance to vibrations acc. to IEC 60068-2-6	5g / 3 ... 150 Hz	
Mounting position	Position 1-6	
Mounting	Mount on the contactor and tighten the screws of the main circuit terminals	
Degree of protection	Housing	IP20
	Main circuit terminals	IP10

Electrical connection

Main circuit

Type	EF65	EF96	EF146
Connecting capacity			
 Rigid	1 x 4 ... 35 mm ² 2 x 4 ... 35 mm ²	6 ... 70 mm ² 6 ... 35 mm ²	10 ... 95 mm ² 10 ... 35 mm ²
 Flexible	1 x 4 ... 35 mm ² 2 x 4 ... 35 mm ²	6 ... 50 mm ² 6 ... 35 mm ²	10 ... 70 mm ² 10 ... 35 mm ²
Stranded acc. to UL/CSA	1 x AWG 10-2 2 x	AWG 8-2	AWG 6-00 AWG 6-2
Flexible acc. to UL/CSA	1 x AWG 10-2 2 x	AWG 8-2	AWG 6-00 AWG 6-2
Stripping length	20 mm	20 mm	20 mm
Tightening torque	4 Nm / 35 lb.in	6 Nm / 55 lb.in	8 Nm / 70 lb.in
Recommended screw driver	M8 (Pozidriv 2)	M8 (Hexagon 4)	M8 (Hexagon 4)

Auxiliary circuit

Type	EF65, EF96, EF146
Connecting capacity	
 Rigid	1 or 2 x 1 ... 4 mm ²
 Flexible with ferrule	1 or 2 x 0.75 ... 2.5 mm ²
 Flexible with insulated ferrule	1 or 2 x 0.75 ... 2.5 mm ²
 Flexible	1 or 2 x 0.75 ... 2.5 mm ²
Stranded acc. to UL/CSA	1 or 2 x AWG 18-10
Flexible acc. to UL/CSA	1 or 2 x AWG 18-10
Stripping length	9 mm
Tightening torque	0.8 ... 1.2 Nm / 7 ... 11 lb.in
Recommended screw driver	M3.5 (Pozidriv 2)

EF205, EF370 electronic overload relays – 63 to 380 A

Ordering details



2CDC231004F0012

EF205-210



2CDC231005F0012

EF370-380



1SFC15124F0002

KPR-101L

Description

The EF205 and EF370 are self-supplied electronic overload relays, which means no extra external supply is needed. It offers reliable protection for motors in the event of overload or phase failure. Easy to use like a thermal overload relay and compatible with standard motor applications, the electronic overload relay is convincing, above all, due to its wide setting range, high accuracy, high operational temperature range and the possibility to select a trip class (10E, 20E, 30E). Further features are the temperature compensation, trip contact (N.C.), signal contact (N.O.), automatic or manual reset selectable, trip-free mechanism, STOP and TEST function and a trip indication. The overload relays are connected directly to the contactors. The EF205 and EF370 have ATEX certification ¹⁾.

Ordering details

Setting range	Short-circuit protective device	Trip class	Type	Order code	Weight (1 pc) kg
A					
63 ... 210	1250 A, fuse type gG	10E, 20E, 30E	EF205-210	1SAX531001R1101	1.210
115 ... 380	1600 A, fuse type gG	10E, 20E, 30E	EF370-380	1SAX611001R1101	1.430

¹⁾ ATEX is valid for products, produced from week 42, 2014.

Ordering details accessories

Suitable for	Description	Type	Order code	Weight (1 pc) kg
EF205, EF370	Reset push button ²⁾	KPR-101L	1SFA616162R1014	0.027
EF205	Terminal shroud	LT200E	1SAX501904R0001	0.085
EF370	Terminal shroud	LT320E	1SAX601904R0001	0.105

²⁾ Note: for more information see catalog 1SFC151004C0201

Main dimensions mm, inches

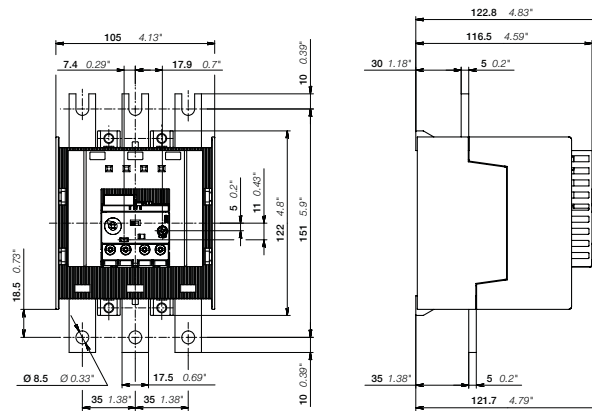

2CDC231004F0012

EF205-210

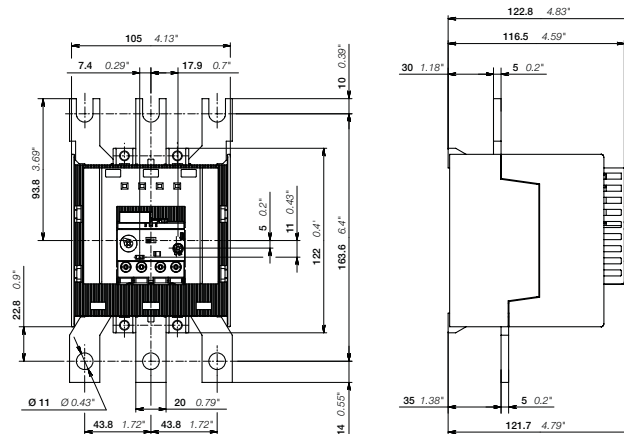

2CDC231005F0012

EF370-380

EF205, EF370 electronic overload relays – 63 to 380 A

Technical data

Main circuit – Utilization characteristics according to IEC/EN

Type	EF205, EF370
Standards	IEC/EN 60947-1, IEC/EN 60947-4-1, IEC/EN 60947-5-1
Rated operational voltage U_n	1000 V AC
Rated frequency	50/60 Hz – not suitable for DC applications
Trip class	10E, 20E, 30E, selectable
Number of poles	3
Duty time	100 %
Operating frequency without early tripping	Up to 15 operations/h, see "Technical diagram – Intermittent periodic duty"
Rated impulse withstand voltage U_{imp}	8 kV
Rated insulation voltage U_i	1000 V

Auxiliary circuit according to IEC/EN

Type	EF205, EF370
Rated operational voltage U_n	600 V AC / DC
Conventional free air thermal current I_{th}	6 A
Rated frequency	DC, 50/60 Hz
Number of poles	1 N.C. + 1 N.O.
I_n / Rated operational current AC-15 acc. to IEC/EN 60947-5-1 for utilization category	
110-120 V	50/60 Hz 3.00 A
220-230-240 V	50/60 Hz 3.00 A
400 V	50/60 Hz 1.10 A
480-500 V	50/60 Hz 0.75 A
I_n / Rated operational current DC-13 acc. to IEC/EN 60947-5-1 for utilization category	
24 V	1.50 A
60 V	0.55 A
110-120-125 V	0.55 A
250 V	0.27 A
Minimum switching capacity	12 V / 3 mA
Short-circuit protective device	6 A, fuse type gG
Rated impulse withstand voltage U_{imp}	6 kV
Rated insulation voltage U_i	690 V

Technical diagram – Intermittent periodic duty

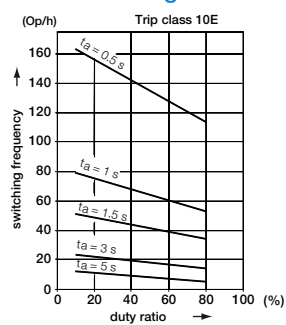

Trip class 10E

2CDC0232001F02.14

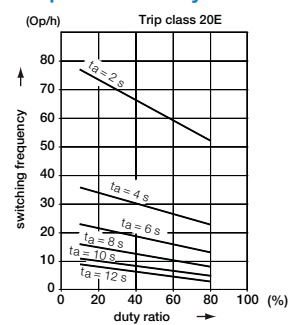

Trip class 20E

2CDC0232002F02.14

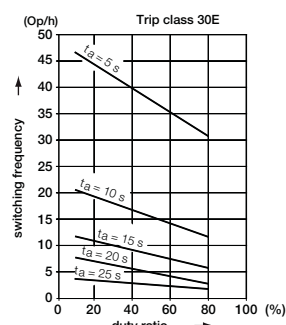

Trip class 30E

2CDC0232003F02.14

EF205, EF370 electronic overload relays – 63 to 380 A

Technical data

Main circuit – Utilization characteristics according to UL/CSA

Type	EF205, EF370
Standards	UL 508, CSA 22.2 No. 14, UL 60947-4-1A
Maximum operational voltage	600 V AC
Trip rating	125 % of FLA
Full load amps (FLA)	See table "Full load amps and short-circuit protective device"
Short-circuit rating RMS symmetrical	See table "Full load amps and short-circuit protective device"
Short-circuit protective device	See table "Full load amps and short-circuit protective device"

Auxiliary circuit according to UL/CSA

Type	EF205, EF370
Contact rating	N.C., 95-96 B600, Q600 N.O., 97-98 B600, Q600
Conventional thermal current	6 A

Full load amps and short-circuit protective device

Type	Full load amps (FLA)	Short-circuit protective device		600 V AC			
		480 V AC		SCCR	Fuse type	SCCR	Fuse type
EF205-210	210 A	10 kA	400 A, R5/RK5	10kA	400 A, R5/RK5	100 kA	400 A, J
EF370-380	380 A	18 kA	800 A, L/T	18kA	800 A, L/T	-	-

EF205, EF370 electronic overload relays – 63 to 380 A





Technical data

General data





Type	EF205	EF370
Pollution degree	3	
Phase loss sensitive	Yes	
Ambient air temperature		
Operation	Open - compensated	
Storage		
Operation	-25 ... +70 °C	
Storage	-50 ... +85 °C	
Ambient air temperature compensation	Acc. to IEC/EN 60947-4-1	
Maximum operating altitude permissible	2000 m	
Resistance to shock acc. to IEC 60068-2-27	25g / 11 ms	
Resistance to vibrations acc. to IEC 60068-2-6	5g / 3 ... 150 Hz	
Mounting position	Position 1-6	
Mounting	Mount on the contactor and tighten the screws of the main circuit terminals	
Degree of protection	Housing	IP20
	Main circuit terminals	IP20

Electrical connection

Main circuit

Type	EF205	EF370
Connecting capacity		
 Rigid	1 x 16 ... 185 mm ² 2 x 16 ... 120 mm ²	50 ... 240 mm ² 50 ... 150 mm ²
 Flexible	1 x 16 ... 185 mm ² 2 x 16 ... 120 mm ²	50 ... 240 mm ² 50 ... 150 mm ²
 Lugs	L ≤ 24 mm	32 mm
 Bars	Ø > 8 mm	10 mm
Stranded acc. to UL/CSA	1 x AWG 6-0000 2 x AWG 6-0000	AWG 1-500 kcmil AWG 1-500 kcmil
Flexible acc. to UL/CSA	1 x AWG 6-0000 2 x AWG 6-0000	AWG 1-500 kcmil AWG 1-500 kcmil
Stripping length	-	-
Tightening torque	18 Nm / 160 lb.in	28 Nm / 247 lb.in
Recommended screw driver	M8	M10

Auxiliary circuit

Type	EF205, EF370
Connecting capacity	
 Rigid	1 or 2 x 1 ... 4 mm ²
 Flexible with ferrule	1 or 2 x 0.75 ... 2.5 mm ²
 Flexible with insulated ferrule	1 or 2 x 0.75 ... 2.5 mm ²
 Flexible	1 or 2 x 0.75 ... 2.5 mm ²
Stranded acc. to UL/CSA	1 or 2 x AWG 18-10
Flexible acc. to UL/CSA	1 or 2 x AWG 18-10
Stripping length	9 mm
Tightening torque	0.8 ... 1.2 Nm / 7 ... 11 lb.in
Recommended screw driver	M3.5 (Pozidriv 2)

EF460, EF750 electronic overload relays – 150 to 800 A

Ordering details



2CDC231016R0013

EF460-500



2CDC231014F0013

EF750-800



1SFC151224R0002

KPR-101L

Description

The EF460 and EF750 are self-supplied electronic overload relays, which means no extra external supply is needed. It offers reliable protection for motors in the event of overload or phase failure. Easy to use like a thermal overload relay and compatible with standard motor applications, the electronic overload relay is convincing, above all, due to its wide setting range, high accuracy, high operational temperature range and the possibility to select a trip class (10E, 20E, 30E). Further features are the temperature compensation, trip contact (N.C.), signal contact (N.O.), automatic or manual reset selectable, trip-free mechanism, STOP and TEST function and a trip indication. Busbar kits are available as accessory for contactor mounting. The EF460 and EF750 have ATEX certification ¹⁾.

Ordering details

Setting range	Short-circuit protective device	Trip class	Type	Order code	Weight (1 pc) kg
A					
EF460 electronic overload relay ¹⁾					
150 ... 500	690 V: 630 A, Type gG 1000 V: 1600 A, Type gG	10E, 20E, 30E	EF460-500	1SAX721001R1101	1.170
EF750 electronic overload relay ¹⁾					
250 ... 800	690 V: 800 A, Type gG 1000 V: 1600 A, Type gG	10E, 20E, 30E	EF750-800	1SAX821001R1101	3.905

¹⁾ ATEX is valid for products, produced from week 42, 2014.

Ordering details accessories

Suitable for	Description	Type	Order code	Weight (1 pc) kg
EF460, EF750	Reset push button ²⁾	KPR-101L	1SFA616162R1014	0.027
EF460	Terminal shroud	LT460EF	1SAX701904R0002	0.320
EF750	Terminal shroud	LT750EF	1SAX801904R0002	0.440

²⁾ Note: for more information see catalog 1SFC151004C0201

Main dimensions mm, inches

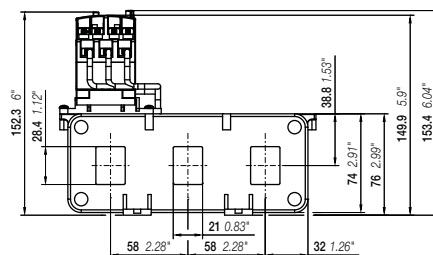

EF460-500

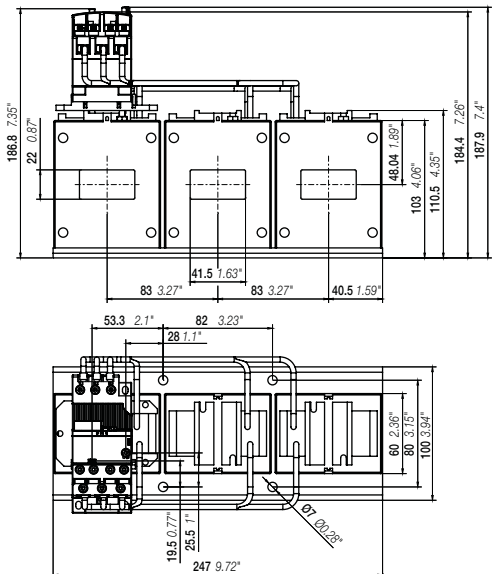

EF750-800

EF460, EF750 electronic overload relays – 150 to 800 A

Technical data

Main circuit – Utilization characteristics according to IEC/EN

Type	EF460	EF750
Standards	IEC/EN 60947-1, IEC/EN 60947-4-1, IEC/EN 60947-5-1	
Rated operational voltage U_n	1000 V AC	
Rated frequency	50/60 Hz – not suitable for DC applications	
Trip class	10E, 20E, 30E, selectable	
Number of poles	3	
Duty time	100 %	
Operating frequency without early tripping	Up to 15 operations/h, see "Technical diagram – Intermittent periodic duty"	
Rated impulse withstand voltage U_{imp}	8 kV	
Rated insulation voltage U_i	1000 V AC	

Auxiliary circuit according to IEC/EN

Type	EF460	EF750
Rated operational voltage U_n	600 V AC / DC	
Conventional free air thermal current I_{th}	6 A	
Rated frequency	DC, 50/60 Hz	
Number of poles	1 N.C. + 1 N.O.	
I_e / Rated operational current AC-15 acc. to IEC/EN 60947-5-1 for utilization category		
110-120 V	50/60 Hz	3.00 A
220-230-240 V	50/60 Hz	3.00 A
400 V	50/60 Hz	1.10 A
480-500 V	50/60 Hz	0.75 A
I_e / Rated operational current DC-13 acc. to IEC/EN 60947-5-1 for utilization category		
24 V		1.50 A
60 V		0.55 A
110-120-125 V		0.55 A
250 V		0.27 A
Minimum switching capacity	12 V / 3 mA	
Short-circuit protective device	6 A, fuse type gG	
Rated impulse withstand voltage U_{imp}	6 kV	
Rated insulation voltage U_i	690 V	

Technical diagram – Intermittent periodic duty

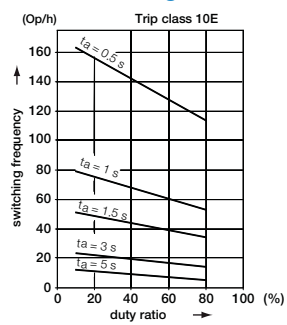

Trip class 10E

2CDC332010P0214

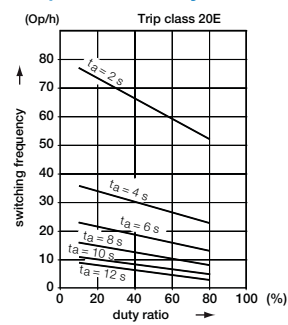

Trip class 20E

2CDC332020P0214

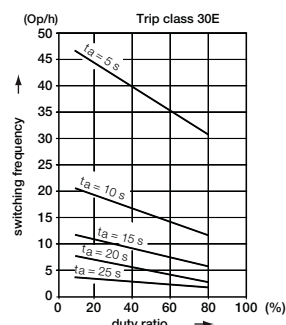

Trip class 30E

2CDC332030P0214

EF460, EF750 electronic overload relays – 150 to 800 A

Technical data

Main circuit – Utilization characteristics according to UL/CSA

Type	EF460	EF750
Standards	UL60947-1, UL60947-4-1	
Maximum operational voltage	600 V AC	
Trip rating	125 % of FLA	

Auxiliary circuit according to UL/CSA





Type	EF460	EF750
Contact rating	N.C., 95-96	B600, Q300
	N.O., 97-98	B600, Q300
Conventional thermal current	5 A	

General data

Type	EF460	EF750
Pollution degree	3	
Phase loss sensitive	Yes	
Ambient air temperature		
Operation	Open - compensated	-25 ... +70 °C
Storage		-25 ... +70 °C
Ambient air temperature compensation	Acc. to IEC/EN60947-4-1	
Maximum operating altitude permissible	2000 m	
Resistance to shock acc. to IEC 60068-2-27	25g / 11 ms	
Resistance to vibrations acc. to IEC 60068-2-6	3g / 3 ... 150 Hz	
Degree of protection	Housing	IP20
	Main circuit terminals	IP00

Electrical connection

Auxiliary circuit

Type	EF460	EF750
Connecting capacity		
 Rigid	1 or 2 x	1 ... 4 mm ²
 Flexible with ferrule	1 or 2 x	0.75 ... 2.5 mm ²
 Flexible with insulated ferrule	1 or 2 x	0.75 ... 2.5 mm ²
 Flexible	1 or 2 x	0.75 ... 2.5 mm ²
Stranded acc. to UL/CSA	1 or 2 x	AWG 18-10
Flexible acc. to UL/CSA	1 or 2 x	AWG 18-10
Stripping length	9 mm	
Tightening torque	0.8 ... 1.2 Nm / 7 ... 11 lb.in	
Recommended screw driver	M3.5 (Pozi driv 2)	

E1250DU electronic overload relays – 375 to 1250 A

Ordering details

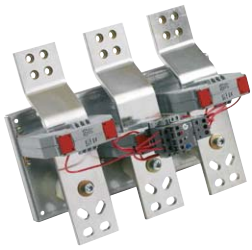

1SFC101025R2001

E1250DU-1250

Description

The E1250DU are self-supplied electronic overload relays, which means no extra external supply is needed. It offers reliable protection for motors in the event of overload or phase failure. Easy to use like a thermal overload relay and compatible with standard motor applications, the electronic overload relay is convincing, above all, due to its wide setting range, high accuracy, high operational temperature range and the possibility to select a trip class (10E, 20E, 30E). Further features are the temperature compensation, trip contact (N.C.), signal contact (N.O.), automatic or manual reset selectable, trip-free mechanism, STOP and TEST function and a trip indication. Busbar kits are available as accessory for contactor mounting.

Ordering details

Setting range	Short-circuit protective device	Trip class	Type	Order code	Weight (1 pc) kg
A					
E1250DU electronic overload relay					
375 ... 1250	-	10E, 20E, 30E	E1250DU-1250	1SFA739001R1000	12.181

E1250DU electronic overload relays – 375 to 1250 A

Technical data

Main circuit – Utilization characteristics according to IEC/EN

Type	E1250DU
Standards	IEC/EN 60947-1, IEC/EN 60947-4-1, IEC/EN 60947-5-1
Rated operational voltage U_e	1000 V AC
Rated frequency	50/60 Hz – not suitable for DC applications
Trip class	10E, 20E, 30E, selectable
Number of poles	3
Duty time	100 %
Operating frequency without early tripping	Up to 15 operations/h, see "Technical diagram – Intermittent periodic duty"
Rated impulse withstand voltage U_{imp}	8 kV
Rated insulation voltage U_i	1000 V AC

Auxiliary circuit according to IEC/EN

Type	E1250DU	
Rated operational voltage U_e	600 V AC / DC	
Conventional free air thermal current I_{th}	6 A	
Rated frequency	DC, 50/60 Hz	
Number of poles	1 N.C. + 1 N.O.	
I_e / Rated operational current AC-15 acc. to IEC/EN 60947-5-1 for utilization category		
110-120 V	50/60 Hz	3.00 A
220-230-240 V	50/60 Hz	3.00 A
440 V	50/60 Hz	1.10 A
480-500 V	50/60 Hz	0.72 A
I_e / Rated operational current DC-13 acc. to IEC/EN 60947-5-1 for utilization category		
24 V		1.50 A
60 V		0.55 A
110-120-125 V		0.55 A
250 V		0.27 A
Minimum switching capacity	12 V / 3 mA	
Short-circuit protective device	6 A, fuse type gG	
Rated impulse withstand voltage U_{imp}	8 kV	
Rated insulation voltage U_i	690 V	

Technical diagram – Intermittent periodic duty

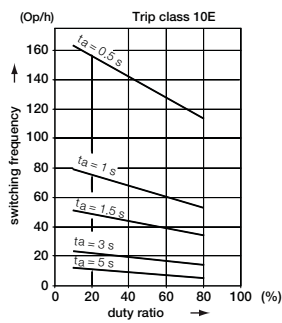

Trip class 10E

2CDC230001F0214

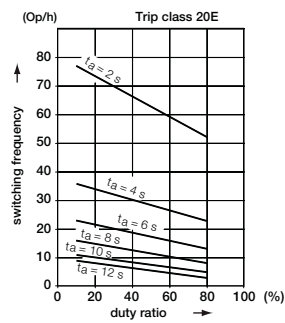

Trip class 20E

2CDC230002F0214

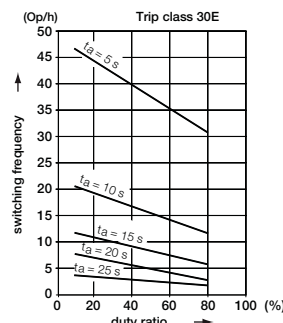

Trip class 30E

2CDC230003F0214

E1250DU electronic overload relays – 375 to 1250 A

Technical data

Main circuit – Utilization characteristics according to UL/CSA

Type	E1250DU	
Standards	UL 508, CSA 22.2 No. 14	
Maximum operational voltage	600 V AC	
Trip rating	125 % of FLA	

Auxiliary circuit according to UL/CSA





Type	E1250DU	
Contact rating	N.C., 95-96	B600, Q300
	N.O., 97-98	B600, Q300
Conventional thermal current	5 A	

General data

Type	E1250DU	
Pollution degree	3	
Phase loss sensitive	Yes	
Ambient air temperature		
Operation	Open - compensated	-25 ... +70 °C
Storage		-50 ... +85 °C
Ambient air temperature compensation	Acc. to IEC/EN60947-4-1	
Maximum operating altitude permissible	2000 m	
Resistance to shock acc. to IEC 60068-2-27	15g / 11 ms	
Resistance to vibrations acc. to IEC 60068-2-6	5g / 3 ... 150 Hz	
Degree of protection	Housing	IP20
	Main circuit terminals	IP20

Electrical connection

Auxiliary circuit

Type	E1250DU	
Connecting capacity		
 Rigid	1 or 2 x	1 ... 4 mm ²
 Flexible with ferrule	1 or 2 x	0.75 ... 2.5 mm ²
 Flexible with insulated ferrule	1 or 2 x	0.75 ... 2.5 mm ²
 Flexible	1 or 2 x	0.75 ... 2.5 mm ²
	Stranded acc. to UL/CSA	AWG 16-10
	Flexible acc. to UL/CSA	AWG 16-10
Stripping length	9 mm	
Tightening torque	0.8 ... 1.2 Nm / 7 lb.in	
Recommended screw driver	M3.5 (Pozidriv 2)	

Thermal and electronic overload relays

General accessories

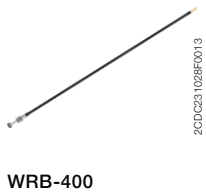

Description

The wire reset is a general accessory for thermal and electronic overloads relays. In installations which are difficult to access, like a motor control centre or compact cubical, the accessory allows the user to remotely reset the overload relays.

The wire reset consists of two parts, the bowden wire with actuator and the holder. The actuator should be mounted into a door of a panel. The holder will be mounted on the overload relay. The actuator and holder are connected via the bowden wire.

Ordering details

Suitable for	Description	Length mm	Type	Order code	Weight (1 pc) kg
Holder					
TF42, TF65, TF96, EF19, EF45, EF65, EF96, EF146, EF205, EF370, EF460, EF750	Holder for tool less direct mounting		WRH-F	1SAZ701903R1001	0.006
Bowden wire with actuator					
WRH-F	Bowden wire with actuator, hole diameter: 7.3 mm, maximum panel thickness: 12 mm	400	WRB-400	1SAZ701903R1011	0.030
		600	WRB-600	1SAZ701903R1012	0.040
		1000	WRB-1000	1SAZ701903R1013	0.060
IP54 gasket					
WRB-400 WRB-600 WRB-1000	IP54 Panel seal gasket		WRBG	1SAZ701903R1030	0.037

Overload relays with accessory wire reset (WRH, WRB)

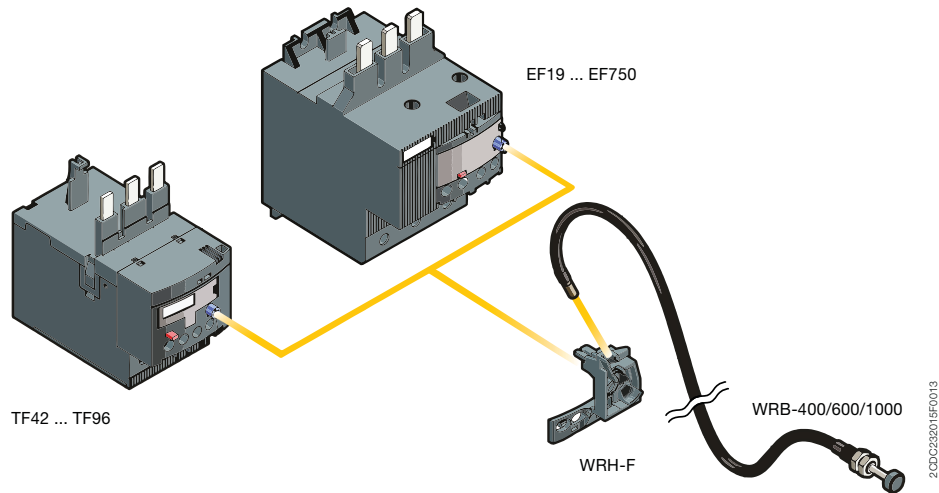



DRAS and DRAF enclosed starters

DRAS enclosed starter

Ordering details	8/2
Control supply wiring versions	8/3
Wiring diagram	8/3
Main dimensions	8/3
Voltage code table	8/4

DRAF enclosed starter

Experience reliable and easy to install	
motor starting	8/6
Ordering details	8/8
Control supply wiring versions	8/10
Wiring diagram	8/10
Main dimensions	8/10

DRAS09 ... DRAS16 enclosed direct-on-line starters

4 to 7.5 kW, protected by thermal overload relays

AC or DC operated



1SBC133003V0014

DRAS
+ T16 to be ordered separately

Description

Enclosed direct-on-line (DOL) starters are used for controlling 3-phase asynchronous motors up to 690 V AC.

Each starter is delivered assembled and wired. It contains:

- IP65 compact plastic enclosure with double insulation, equipped with:
 - 1 green flush "I" ON button and 1 red protruding "O" OFF/RESET button
 - 2 quarter-turn, quick fastening screws and a base with 6 cable inlets and outlets via knockouts.
- 1 AS or ASL 3-pole contactor with holding contact
- 1 PE and 1 neutral terminal.

3 versions of control supply wiring are available: phase-to-phase, separate supply or phase-to-neutral.

T16 thermal overload relay has to be ordered separately and chosen according to motor's nominal current (see table below).

DRAS, DRASL enclosed DOL starters

IEC - AC-3				Rated control circuit voltage Uc Other control voltages see AS voltage code table	Control supply wiring	Type	Order code	Weight Pkg (1 pce) kg
Rated operational power	400 V	500 V	max. current $\theta \leq 40^\circ\text{C}$ Ue=400 V					
220 V				V 50/60 Hz	V DC			
230 V								
240 V								
kW	kW	kW	A					

AC operated with AS 3-pole contactors

2.2	4	4	9	24	-	Separate supply	DRAS09-20S	1SBK104235R2000	0.650
				230	-	Phase-to-neutral	DRAS09-26N	1SBK104135R2600	0.650
				240	-	Phase-to-neutral	DRAS09-27N	1SBK104135R2700	0.650
				400	-	Phase-to-phase	DRAS09-28P	1SBK104035R2800	0.650
				415	-	Phase-to-phase	DRAS09-29P	1SBK104035R2900	0.650
3	5.5	5.5	12	24	-	Separate supply	DRAS12-20S	1SBK114235R2000	0.650
				230	-	Phase-to-neutral	DRAS12-26N	1SBK114135R2600	0.650
				240	-	Phase-to-neutral	DRAS12-27N	1SBK114135R2700	0.650
				400	-	Phase-to-phase	DRAS12-28P	1SBK114035R2800	0.650
				415	-	Phase-to-phase	DRAS12-29P	1SBK114035R2900	0.650
4	7.5	7.5	15.5	24	-	Separate supply	DRAS16-20S	1SBK124235R2000	0.650
				230	-	Phase-to-neutral	DRAS16-26N	1SBK124135R2600	0.650
				240	-	Phase-to-neutral	DRAS16-27N	1SBK124135R2700	0.650
				400	-	Phase-to-phase	DRAS16-28P	1SBK124035R2800	0.650
				415	-	Phase-to-phase	DRAS16-29P	1SBK124035R2900	0.650

DC operated with ASL 3-pole contactors

2.2	4	4	9	-	24	Separate supply	DRASL09-81S	1SBK104335R8100	0.700
				-	48		DRASL09-83S	1SBK104335R8300	0.700
3	5.5	5.5	12	-	24	Separate supply	DRASL12-81S	1SBK114335R8100	0.700
				-	48		DRASL12-83S	1SBK114335R8300	0.700
4	7.5	7.5	15.5	-	24	Separate supply	DRASL16-81S	1SBK124335R8100	0.700
				-	48		DRASL16-83S	1SBK124335R8300	0.700

T16 thermal overload relays to be ordered separately

Setting range	Short-circuit protective device	Trip class	Type	Order code	Weight (1 pce) kg
A					
0.10...0.13	0.5 A, Fuse type T	10	T16-0.13	1SAZ711201R1005	0.100
0.13...0.17	1.0 A, Fuse type T		T16-0.17	1SAZ711201R1008	0.100
0.17...0.23			T16-0.23	1SAZ711201R1009	0.100
0.23...0.31			T16-0.31	1SAZ711201R1013	0.100
0.31...0.41	2.0 A, Fuse type gG		T16-0.41	1SAZ711201R1014	0.100
0.41...0.55			T16-0.55	1SAZ711201R1017	0.100
0.55...0.74	4.0 A, Fuse type gG		T16-0.74	1SAZ711201R1021	0.100
0.74...1.00	6.0 A, Fuse type gG		T16-1.0	1SAZ711201R1023	0.100
1.00...1.30			T16-1.3	1SAZ711201R1025	0.100
1.30...1.70	10.0 A, Fuse type gG		T16-1.7	1SAZ711201R1028	0.100
1.70...2.30			T16-2.3	1SAZ711201R1031	0.100
2.30...3.10			T16-3.1	1SAZ711201R1033	0.100
3.10...4.20	20.0 A, Fuse type gG		T16-4.2	1SAZ711201R1035	0.100
4.20...5.70			T16-5.7	1SAZ711201R1038	0.100
5.70...7.60	35.0 A, Fuse type gG		T16-7.6	1SAZ711201R1040	0.100
7.60...10.0			T16-10	1SAZ711201R1043	0.104
10.0...13.0	40.0 A, Fuse type gG		T16-13	1SAZ711201R1045	0.104
13.0...16.0			T16-16	1SAZ711201R1047	0.104

Empty enclosure with push-button

-	-	-	FR16AS-12VARS	1SBN101035R1000	0.394
---	---	---	---------------	-----------------	-------

To be completed with AS or ASL contactor, T16 thermal overload relay and MCB-10B (1SFA611610R2001) contact block.



T16

2CDC31003V0013



1SBC133001V0014

Empty enclosure
with push-button

DRAS09 ... DRAS16 and DRASL09 ... DRASL16 enclosed direct-on-line starters

Control supply wiring versions

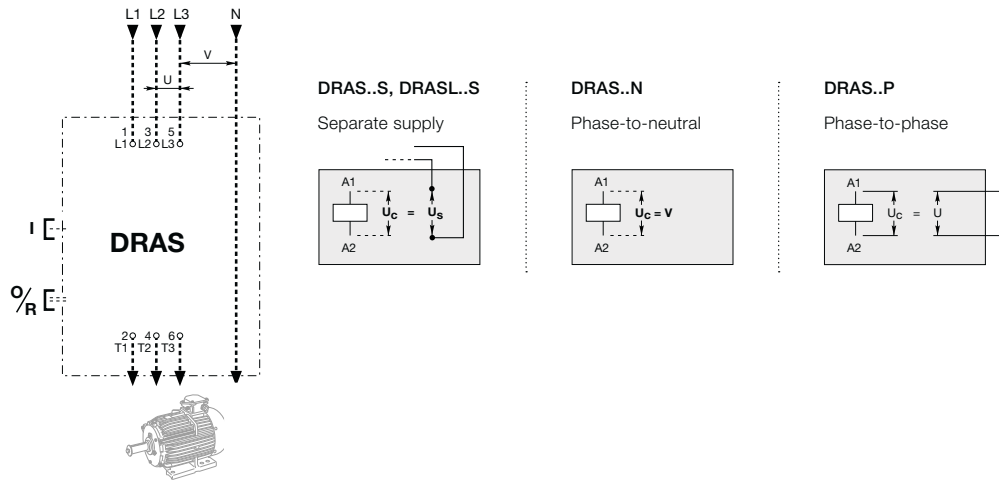

Wiring diagram

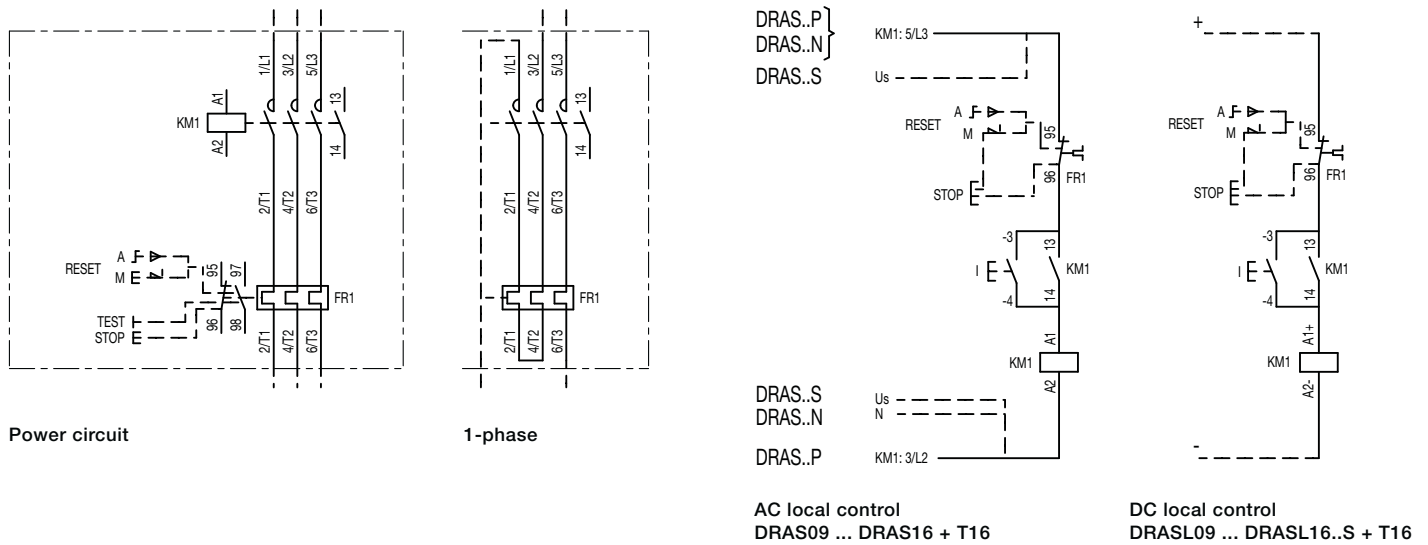

Main dimensions mm, inches

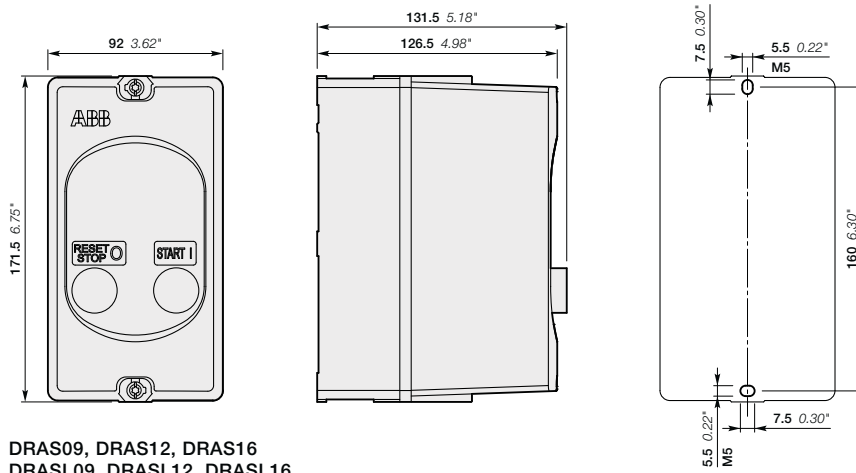

DRAS09, DRAS12, DRAS16
DRASL09, DRASL12, DRASL16

Cable inlets		Cable outlet
Enclosure top	Enclosure back	Enclosure bottom
2 x \varnothing 20.5/25.5 mm 2 x \varnothing 0.81/1.00"	2 x \varnothing 20.5 mm 2 x \varnothing 0.81"	2 x \varnothing 20.5/25.5 mm 2 x \varnothing 0.81/1.00"
\varnothing 20.5mm - \varnothing 0.81" for ISO M20		
\varnothing 25.5mm - \varnothing 1.00" for ISO M25		

18BEC133002S0201

Voltage code table

DRAS09 ... DRAS16 and DRASL09 ... DRASL16 enclosed DOL starters

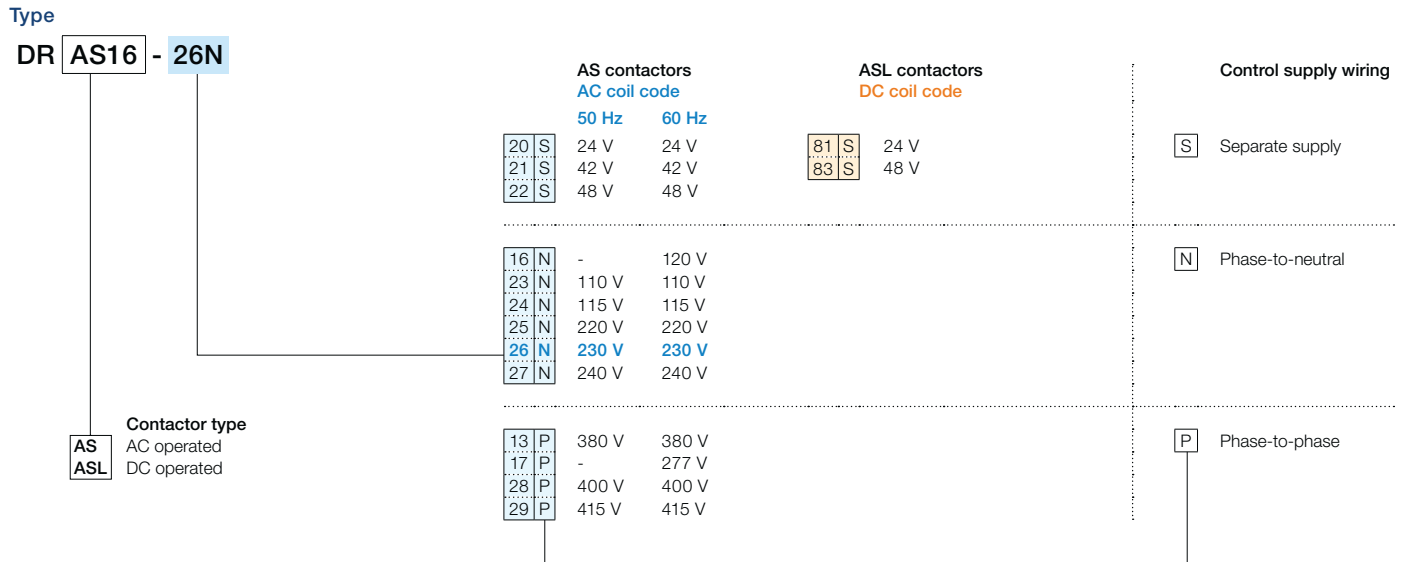

Notes

A series of horizontal dotted lines for writing notes, spanning the width of the page.

DRAF enclosed direct-on-line starters

Experience reliable and easy to install motor starting



Improve installation efficiency

- Easy to connect and to operate
- Pre-wired control circuit and easy to follow wiring instructions
- Coil energy consumption down by 80%.



Reliable in harsh condition

- High number of electrical and mechanical operations
- Robust IP66 and type 4X enclosure
- Double electrical insulation.

8



Continuous operation

- AF contactors manage voltage fluctuation, chattering free
- Protected motor with thermal overload relay
- Safety through coordinated product.



For machine or wall mounting

Main applications

Control of stand alone motors like for heat pumps, air conditioning units, small machine tools, compressors, pumping, irrigation...



Motor starting solutions up to 7.5 kW and 10 hp

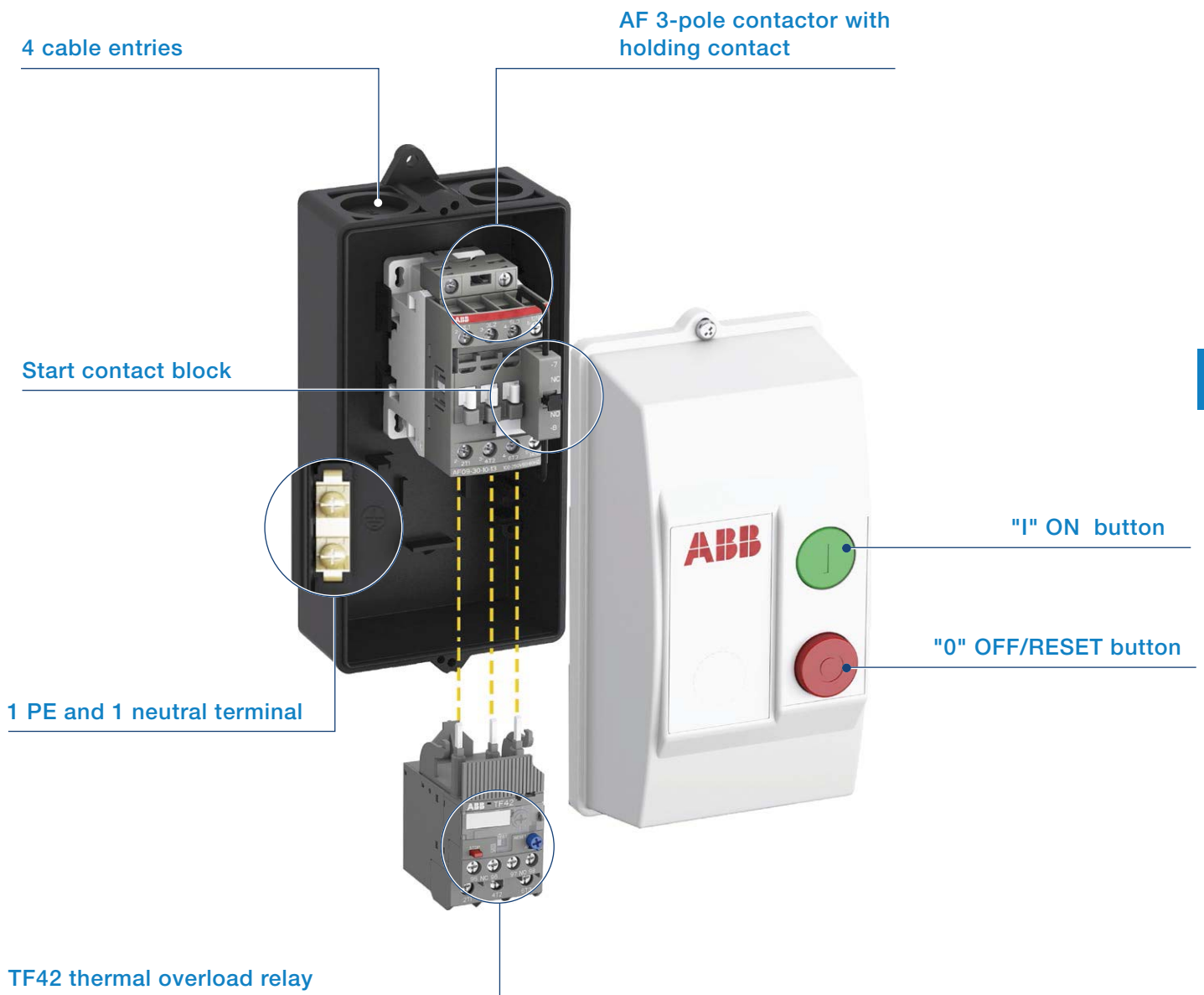

DRAF09 ... DRAF16 enclosed direct-on-line starters

Up to 7.5 kW and 10 hp, protected by thermal overload relays

AC operated



1SBK133006S0201

DRAF
+ TF42 to be ordered separately

Description

Enclosed direct-on-line (DOL) starters are used for controlling 3-phase asynchronous motors up to 690 V AC.

Each starter is delivered assembled and wired. It contains:

- IP66 and type 4X plastic enclosure with double insulation, equipped with:
 - 1 green flush "I" ON button and 1 red protruding "O" OFF/RESET button
 - 4 cable inlets and outlets via knockouts.
- 1 AF 3-pole contactor with holding contact
- 1 CB5-10 start contact block
- 1 PE and 1 neutral terminal.

Control supply wiring:

IEC starters type: phase-to-phase, separate supply or phase-to-neutral.

UL starters type: separate supply.

TF42 thermal overload relay to be ordered separately and chosen according to motor's nominal current (see table in the next page).

DRAF enclosed DOL starters

IEC - AC-3					Control supply wiring	Rated control circuit voltage Uc min ... Uc max (1)	Type	Order code	Weight Pkg (1 pce) kg
Rated operational power				max. current $\theta \leq 40^\circ\text{C}$ Ue=400 V A					
220 V	380 V	500 V	690 V						
230 V	400 V								
240 V									
kW	kW	kW	kW			V 50/60 Hz			
IEC starters type									
2.2	4	5.5	5.5	9	Separate supply	24...60	DRAF09-11S	1SBK134237R1100	0.820
					Phase-to-neutral	100...250	DRAF09-13N	1SBK134137R1300	0.820
					Phase-to-phase	250...500	DRAF09-14P	1SBK134037R1400	0.820
3	5.5	7.5	7.5	12	Separate supply	24...60	DRAF12-11S	1SBK154237R1100	0.820
					Phase-to-neutral	100...250	DRAF12-13N	1SBK154137R1300	0.820
					Phase-to-phase	250...500	DRAF12-14P	1SBK154037R1400	0.820
4	7.5	9	9	18	Separate supply	24...60	DRAF16-11S	1SBK174237R1100	0.820
					Phase-to-neutral	100...250	DRAF16-13N	1SBK174137R1300	0.820
					Phase-to-phase	250...500	DRAF16-14P	1SBK174037R1400	0.820

(1) Select DRAF.S with separate supply for 24...60 V DC control circuit voltage (change A2 - Us wire to blue color acc. to IEC 60947-4-1).

UL starter type with separate control supply wiring

UL / CSA						Rated control circuit voltage Uc min ... Uc max	Type	Order code	Weight Pkg (1 pce) kg
Horse power ratings									
Single phase motor			Three phase motor						
120 V	240 V		200 V	220 V	440 V				
			208 V	240 V	480 V	550 V			
600 V									
hp	hp	hp	hp	hp	hp	hp	V 50/60 Hz		
UL starters type									
0.75	1.5	2	2	5	7.5	24...60	DRAF09-11U	1SBK134238R1100	0.820
						100...250	DRAF09-13U	1SBK134238R1300	0.820
						250...500	DRAF09-14U	1SBK134238R1400	0.820
1	2	3	3	7.5	10	24...60	DRAF12-11U	1SBK154238R1100	0.820
						100...250	DRAF12-13U	1SBK154238R1300	0.820
						250...500	DRAF12-14U	1SBK154238R1400	0.820
1.5	3	5	5	10	15	24...60	DRAF16-11U	1SBK174238R1100	0.820
						100...250	DRAF16-13U	1SBK174238R1300	0.820
						250...500	DRAF16-14U	1SBK174238R1400	0.820

1SBK133006S0201

DRAF09 ... DRAF16 enclosed direct-on-line starters

Up to 7.5 kW and 10 hp, protected by thermal overload relays

AC operated



TF42



Empty enclosure with push-button

TF42 thermal overload relays to be ordered separately

Setting range	Short-circuit protective device	Trip class	Type	Order code	Weight (1 pce) kg
A					
0.10 ... 0.13	0.5 A, Fuse type T	10	TF42-0.13	1SAZ721201R1005	0.130
0.13 ... 0.17	1.0 A, Fuse type T	10	TF42-0.17	1SAZ721201R1008	0.130
0.17 ... 0.23	1.0 A, Fuse type T	10	TF42-0.23	1SAZ721201R1009	0.130
0.23 ... 0.31	1.0 A, Fuse type T	10	TF42-0.31	1SAZ721201R1013	0.130
0.31 ... 0.41	2.0 A, Fuse type gG	10	TF42-0.41	1SAZ721201R1014	0.130
0.41 ... 0.55	2.0 A, Fuse type gG	10	TF42-0.55	1SAZ721201R1017	0.130
0.55 ... 0.74	4.0 A, Fuse type gG	10	TF42-0.74	1SAZ721201R1021	0.130
0.74 ... 1.00	6.0 A, Fuse type gG	10	TF42-1.0	1SAZ721201R1023	0.130
1.00 ... 1.30	6.0 A, Fuse type gG	10	TF42-1.3	1SAZ721201R1025	0.130
1.30 ... 1.70	10.0 A, Fuse type gG	10	TF42-1.7	1SAZ721201R1028	0.130
1.70 ... 2.30	10.0 A, Fuse type gG	10	TF42-2.3	1SAZ721201R1031	0.130
2.30 ... 3.10	10.0 A, Fuse type gG	10	TF42-3.1	1SAZ721201R1033	0.130
3.10 ... 4.20	20.0 A, Fuse type gG	10	TF42-4.2	1SAZ721201R1035	0.130
4.20 ... 5.70	20.0 A, Fuse type gG	10	TF42-5.7	1SAZ721201R1038	0.130
5.70 ... 7.60	35.0 A, Fuse type gG	10	TF42-7.6	1SAZ721201R1040	0.130
7.60 ... 10.0	35.0 A, Fuse type gG	10	TF42-10	1SAZ721201R1043	0.130
10.0 ... 13.0	40.0 A, Fuse type gG	10	TF42-13	1SAZ721201R1045	0.130
13.0 ... 16.0	40.0 A, Fuse type gG	10	TF42-16	1SAZ721201R1047	0.130
16.0 ... 20.0	63.0 A, Fuse type gG	10	TF42-20	1SAZ721201R1049	0.145

Empty enclosure with push-button

mm cable inlet/outlet suitable for IEC starter types	-	FR16AF-12	1SBN101337R1000	0.53
Inch cable inlet/outlet suitable for UL starter types	-	FR16AF-12U	1SBN101338R1000	0.53

To be completed with AF contactor, TF42 thermal overload relay and CB5-10 (1SBN010013R1010) start contact block.

DRAF09 ... DRAF16 enclosed direct-on-line starters

Control supply wiring versions

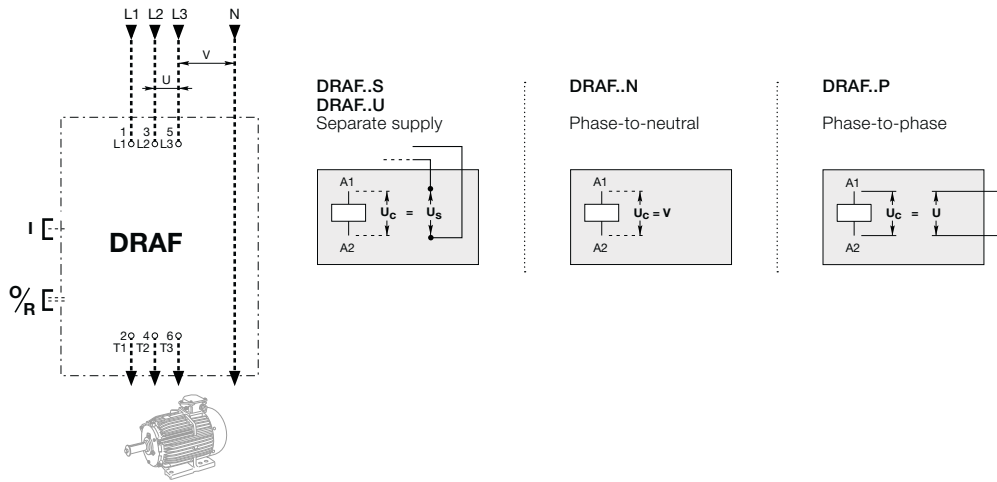

Wiring diagram

Power circuit

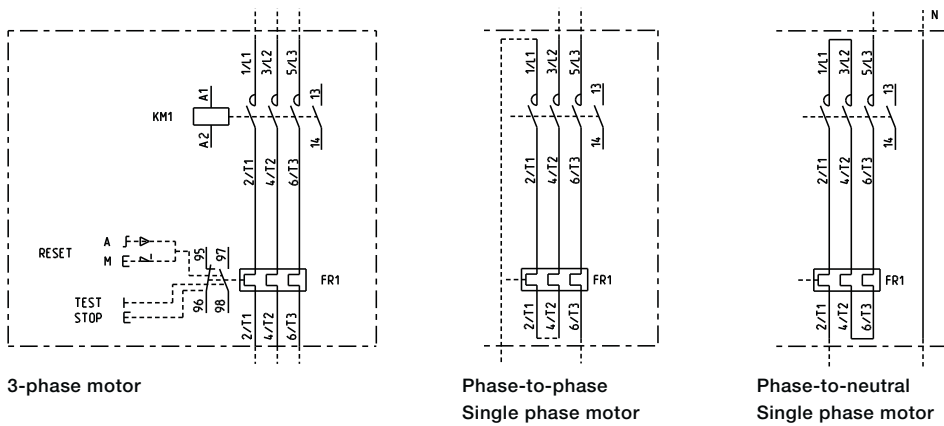

3-phase motor

Phase-to-phase
Single phase motor

Phase-to-neutral
Single phase motor

AC local control

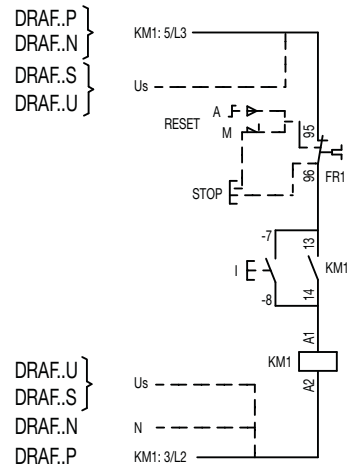

Main dimensions mm, inches

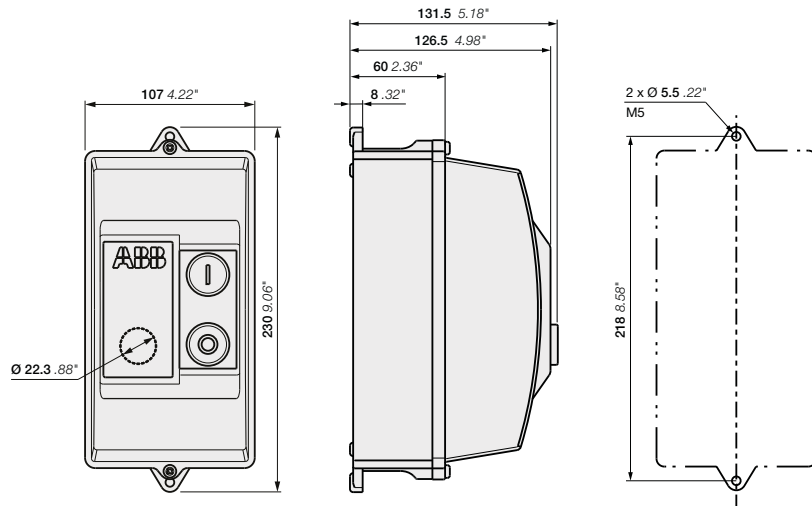

DRAF09, DRAF12, DRAF16

IEC starter types - ISO M20

Cable inlet	Cable outlet
Enclosure top 2 x ø 20 mm 2 x ø 0.79"	Enclosure bottom 2 x ø 20 mm 2 x ø 0.79"

UL starter types - NPT

Cable inlet	Cable outlet
Enclosure top 1 x 3/4" 1 x 1/2"	Enclosure bottom 1 x 3/4" 1 x 1/2"

Notes

A series of horizontal dotted lines for writing notes.

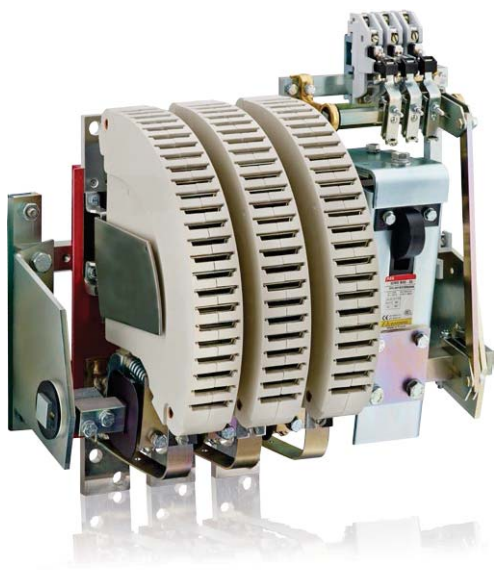

R contactors

[Presentation](#) 9/2

Overview

R contactors for the AC circuits switching 9/4

R contactors for the DC circuits switching 9/6

[Questionnaire](#) 9/8

Download



For additional information refer to our main catalog.

[Download main catalog](#)

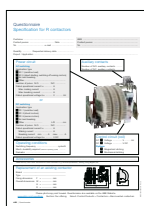

Submit your request with the dedicated form. Our expert will define the right contactor for your application.

[Download the form](#)



R contactors

Tailored to your needs

With over 100 years of experience in control, ABB has designed its R contactors to meet the particular requirements of power applications from 63 A up to 5000 A in AC and DC.

With a variable number of poles and advanced features, these tailor-made bar mounted contactors remain the most flexible solution. Robustness and reliability bring our technology far beyond the limits of standard contactors. Our know-how enables us to offer R contactors perfectly suited to your applications whatever the environment.

Performance

- High making and breaking capacity
- Current up to 5000 A
- Voltage up to 1000 V AC or 1500 V DC.

Flexibility

- Variable number of poles
- Combination of N.O. and N.C. poles
- Adjustable number of auxiliary contacts.

Reliability

- Robust construction
- Durability up to 5 millions of operating cycles
- Experienced and proven for years.

... you can trust

Easy maintenance

- Direct access to all the contactor parts for inspection or replacement
- Complete and didactic instruction manual for installation, inspection or maintenance
- Dedicated R contactors service support available by ABB.

From standard to tailor-made solution

- Pre-sales support to identify and define customer requirements
- Customized support with development of solutions from specifications
- Specialists available to optimize your configuration.

Sustainability of control for a wide variety of applications

- | | | |
|-----------------------------|--------------------------------|----------------------|
| – Iron and steel industries | – Hydroelectric power stations | – Railway substation |
| – Mining | – Photovoltaic power plants | – Lighting equipment |
| – Cranes | – Power distribution | – Pump stations. |
| – Induction furnaces | – Energy storage | |



R contactors

Get the right product

Conventional applications

AC circuit switching

Up to 500 V AC
IOR contactors

From 500 up to 1000 V AC
IOR..MT contactors

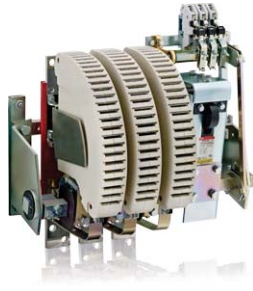

AC-1 Rated operational current up to 5000 A
AC-3 Rated power up to 1500 kW (1520 A - 440 V)

DC circuit switching

Up to 1500 V DC with poles in series
IOR..CC contactors



DC-1 Rated operational current up to 5000 A
DC-3 / DC-5 operational current up to 2000 A

Advanced applications

N.O./N.C. main poles combination

AC circuit switching
NOR..MT contactors

DC circuit switching
NOR..CC contactors



Power circuit coupling

Up to 1000 V AC / 1500 V DC
LOR couplers



Slip-ring motor control

Uer up to 5000 V AC
FOR contactors



Energy saving and safety requirements

Equipped with latching
..AMA, ..AME contactor types

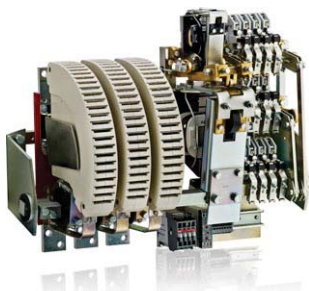

Alternator field discharge

Umax 2250 V DC
AM-CC-JORE contactors

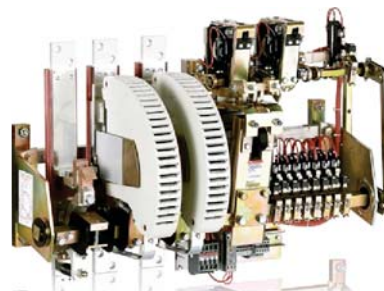

R contactors for AC circuit switching

Rated operational voltage

U_e from 500 up to **1000 V AC**



Contactor type	AC control circuit	~	IORR63..MT	IORR125..MT	IORR200..MT	IORR400..MT	IORR500..MT	IORR800..MT
	DC control circuit	≡	IORE63..MT	IORE125..MT	IORE200..MT	IORE400..MT	IORE500..MT	IORE800..MT
Categories	U _e							
AC-1	at 40 °C	I _e	85 A	170 A	260 A	400 A	550 A	800 A
AC-3	690 V AC	I _e	85 A	160 A	260 A	400 A	550 A	800 A
	1000 V AC max.	I _e	56 A	105 A	180 A	280 A	380 A	580 A
AC-3	690 V AC	Power	80 kW	150 kW	240 kW	400 kW	540 kW	780 kW

9

Rated operational voltage

U_e up to **500 V AC**

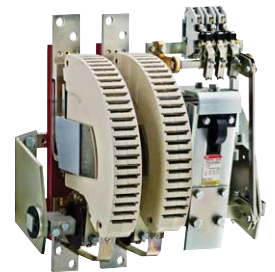

Contactor type	AC control circuit	~	-					IORR800
	DC control circuit	≡	-					IORE800
Categories	U _e							
AC-1	at 40 °C	I _e	From 85 A to 550 A, select above IOR...-MT					900 A
AC-3	380-415-440 V AC	I _e	-					800 A
	500 V AC max.	I _e	-					800 A
AC-3	400 V AC	Power	-					450 kW

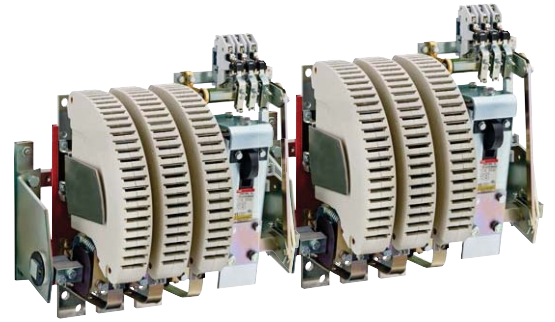
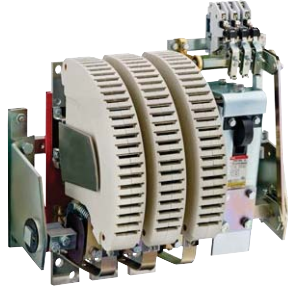
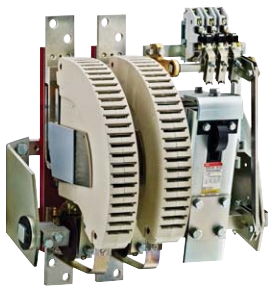

IORR1400..MT	IORR1700..MT	IORR2100..MT	IORR2500..MT	IORR3200..MT	IORR3800..MT	IORR4500..MT	IORR5100..MT
IORE1400..MT	IORE1700..MT	IORE2100..MT	IORE2500..MT	IORE3200..MT	IORE3800..MT	IORE4500..MT	IORE5100..MT

1250 A	1650 A	1850 A	2200 A	3000 A	3500 A	4000 A	4500 A
970 A	1170 A	1270 A	-	-	-	-	-
610 A	680 A	810 A	-	-	-	-	-
1000 kW	1200 kW	1300 kW	-	-	-	-	-

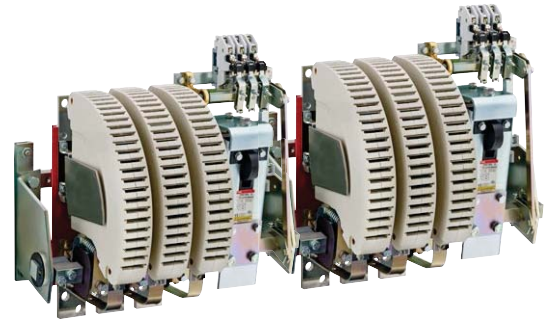
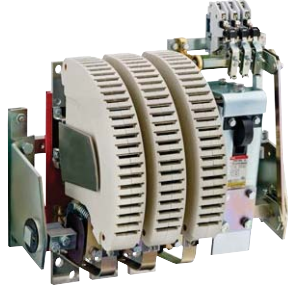
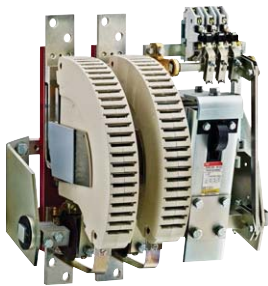

IORR1000	IORR1400	IORR1700	IORR2100	IORR2500	IORR3200	IORR3800	IORR4500	IORR5100
IORE1000	IORE1400	IORE1700	IORE2100	IORE2500	IORE3200	IORE3800	IORE4500	IORE5100

1000 A	1350 A	1650 A	2000 A	2400 A	3200 A	3800 A	4500 A	5000 A
800 A	1080 A	1260 A	1520 A	-	-	-	-	-
800 A	1080 A	1220 A	1340 A	-	-	-	-	-
450 kW	630 kW	750 kW	900 kW	-	-	-	-	-

R contactors for DC circuit switching

Rated operational voltage
 U_e up to **1500 V DC**



Contactor type	AC control circuit	~	IORR63..CC	IORR125..CC	IORR200..CC	IORR400..CC	IORR500..CC
	DC control circuit	≡	IORE63..CC	IORE125..CC	IORE200..CC	IORE400..CC	IORE500..CC
Number of poles in series	Categories	U_e max.					
1 pole	DC-1	500 V DC	le 85 A	170 A	275 A	400 A	550 A
	DC-3 / DC-5	500 V DC	le 68 A	125 A	205 A	350 A	500 A
2 poles	DC-1	1000 V DC	le 85 A	170 A	275 A	400 A*	550 A*
	DC-3 / DC-5	1000 V DC	le 68 A	125 A	205 A	350 A	500 A
3 poles	DC-1	1500 V DC	le 85 A*	170 A*	275 A*	400 A*	550 A*
	DC-3 / DC-5	1500 V DC	le 68 A*	125 A*	205 A*	350 A*	500 A*

* U_e max. = 1500 V DC, version with increased insulation for 1000 V DC < U_e ≤ 1500 V DC, please consult us.

9

Contactors
 UL / CSA approved 

Rated operational voltage
 U_e up to **600 V DC**

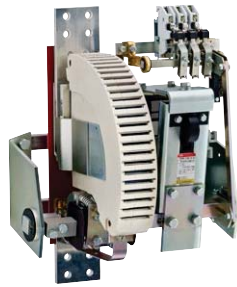

Contactor type	AC control circuit	~	IORR800-10-CC	IORR1000-10-CC	IORR1400-10-CC	IORR1700-10-CC	IORR2100-10-CC
	DC control circuit	≡	IORE800-10-CC	IORE1000-10-CC	IORE1400-10-CC	IORE1700-10-CC	IORE2100-10-CC
		U max.					
1 pole	General use	600 V DC	le 800 A	1000 A	1300 A	1700 A	2000 A

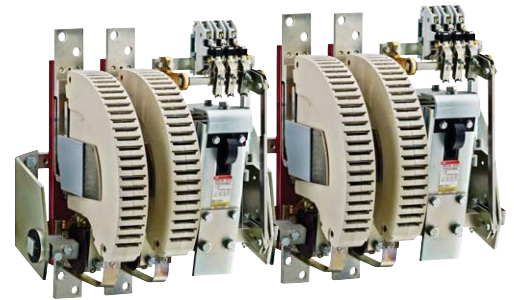
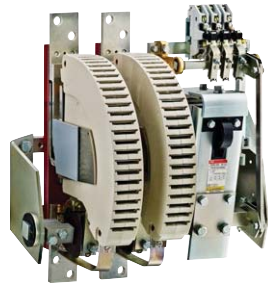
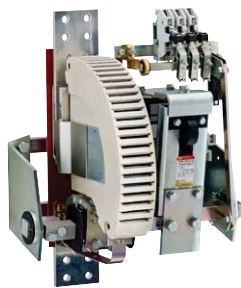

	IORR800.CC	IORR1000.CC	IORR1400.CC	IORR1700.CC	IORR2100.CC	IORR2500.CC	IORR3200.CC	IORR3800.CC	IORR4500.CC	IORR5100.CC
	IORE800.CC	IORE1000.CC	IORE1400.CC	IORE1700.CC	IORE2100.CC	IORE2500.CC	IORE3200.CC	IORE3800.CC	IORE4500.CC	IORE5100.CC

Ue max.

750 V DC	800 A	1000 A	1250 A	1600 A	2000 A	2300 A	3200 A	3800 A	4500 A	5000 A
600 V DC	720 A	1000 A	1250 A	1600 A	2000 A	On request	On request	On request	On request	On request
1500 V DC	800 A	1000 A	1250 A	1600 A	2000 A	2300 A	3200 A	3800 A	4500 A	5000 A
1000 V DC	720 A	1000 A	1250 A	1600 A	2000 A	On request	On request	On request	On request	On request
1500 V DC	800 A	1000 A	1250 A	1600 A	2000 A	2300 A	3200 A	3800 A	4500 A	5000 A
1500 V DC	720 A	1000 A	1250 A	1600 A	2000 A	On request	On request	On request	On request	On request

Questionnaire

Specification for R contactors

Customer
 Contact person Date
 Tel. e-mail

ABB
 Contact person
 Tel.

Quantity Requested delivery date
 Project / Application

Power circuit

AC switching

Application type

- AC-1 (resistive load)
- AC-3 (direct starting, switching off running motors)
- No load breaking
- Other

Number of poles: N.O. N.C.

Rated operational current I_e A

Max. making current A

Max. breaking current A

Rated operational voltage U_e V Hz

or

DC switching

Application type

- DC-1 (resistive load)
- DC-3 (shunt motors)
- DC-5 (series motors)
- No load breaking
- Other L/R ms

Number of poles: N.O. N.C.

Rated operational current I_e A

Making current A

Breaking current min. A max. A

Rated operational voltage U_e V DC

Operating conditions

Switching frequency cycles/h

Mech. durability required (millions of operating cycles)

Remarks

Auxiliary contacts

Number of N.O. auxiliary contacts

Number of N.C. auxiliary contacts

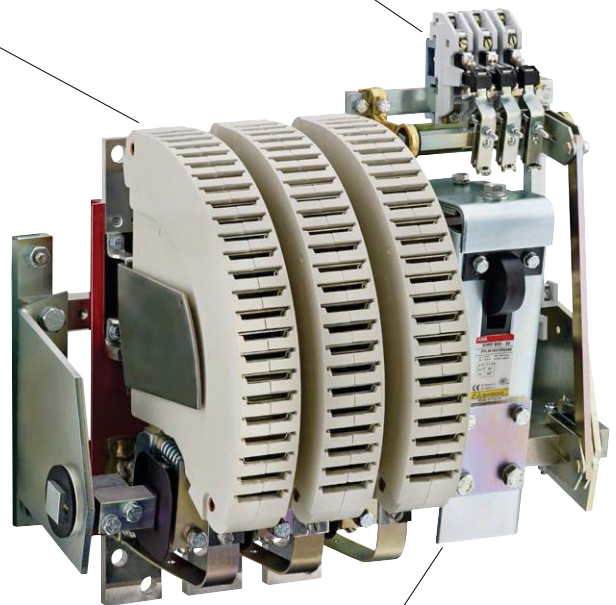

Control circuit (coil)

AC Voltage V Hz

DC Voltage V DC

Options

- Latching (magnetical or mechanical latching acc. to contactor rating)

Accessories

Please add any other useful documents for further information e.g. technical specification, drawing, wiring diagram, etc.

Replacement of an existing contactor

Brand

Type

Fixing dimension F = mm

Overall dimensions W = mm

H = mm

D = mm

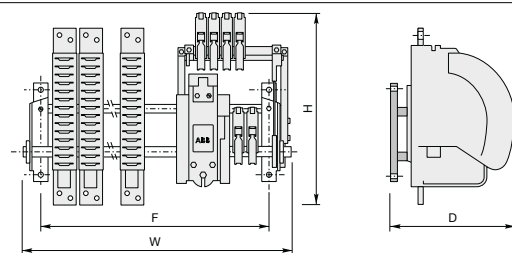

Questionnaire also available on the ABB Website:

www.abb.com/lowvoltage

Section: Our offering

Select: Control Products > Contactors > R bar contactors



Motor control and protection

Motor control and protection

Benefits and advantages	10/2
Technical data	10/3

Motor control and protection

Benefits and advantages

UMC100.3 is a flexible, modular and expandable motor management system for constant-speed low-voltage range motors. It's most important tasks include motor protection, prevention of plant standstills and the reduction of down time. This is made possible by early information relating to possible motor problems which avoids unplanned plant standstills. Even if a motor trips, quick diagnosis of the cause of the fault serves to reduce downtime.

UMC100.3 combines in a very compact unit:

Motor protection

- Overload, underload
- Overvoltage, undervoltage
- Blocked rotor, low / high current
- Phase failure, imbalance, phase sequence
- Earth leakage
- Thermistor protection
- Limitation of starts per time
- One single version with integrated measuring system covers the rated motor current from 0.24 to 63 A

Motor control

- Integrated and easy to parametrize motor starter functions like direct, reverse, star-delta,...
- Additionally free programmable logic for application specific control functions
- Expansion modules DX111, DX122 for more I/Os
- Expansion modules VI150, VI155 for 3-phase voltage measuring
- Analog and temperature module AI111

Motor diagnostics

- Quick and comprehensive access to all relevant data via fieldbus and/or operator panel
- Current, thermal load
- Phase voltages
- Power factor
- Energy

Communication

- Communication-independent basic device
- Freely selectable fieldbus protocol with FieldBusPlug
- Profibus DP
- DeviceNet
- Modbus RTU
- Ethernet Modbus TCP
- Profinet

Typical application segments

- Oil & gas
- Cement
- Paper
- Mining
- Steel
- Chemical industry

Further information

UMC Catalog 2CDC 190 022 C0206

UMC Brochure 2CDC 135 011 B0203

Motor control and protection

Technical data

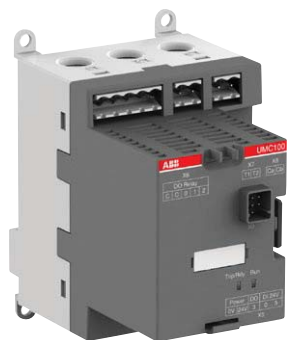

Basic device UMC100.3

Main power

Voltage	max 1000 V AC
Frequency	45...65 Hz
Rated motor current	0.24...63 A, without accessories Higher currents with external transformer
Tripping classes	5E, 10E, 20E, 30E, 40E in accordance with EN/IEC 60947-4-1
Short-circuit protection	Separate fuse on network side

Control unit

Supply voltage	24 V DC, 110-240 V AC/DC
Inputs	6 digital inputs 24 V DC 1 PTC input
Outputs	3 digital relay outputs 1 digital transistor output

Expansion modules

The UMC100.3 can be expanded with maximum 4 expansion modules: One digital expansion module DX111 or DX122, one module VI150 or VI155 and 2 analog modules AI111. Communication takes place via a simple two-wire line. The maximum distance allowed between the UMC100.3 and the expansion module is 3 m.



Digital expansion modules DX111 / DX122

Expands the UMC100.3 to include additional digital inputs and outputs and an analog output

Supply voltage	24 V DC
Inputs	DX111: 8 digital inputs 24 V DC DX122 8 digital inputs 110/230 V AC
Outputs	4 digital relay outputs 1 analog output, 0/4...20 mA, / 0...10 V configurable

Voltage modules VI150/VI155

Voltage modules for determining phase voltages, power factor (cos ϕ), active power, apparent power, energy, harmonic content (THD)

VI150 for use in grounded networks

VI155 for use in grounded and ungrounded networks

Supply voltage	24 V DC
Voltage inputs	L1, L2, L3
Rated voltage range	150 ... 690 V AC
Outputs	1 digital relay output



Analog module AI111

Expand the UMC100.3 with analog and temperature inputs

Supply voltage	24 V DC
Inputs	0-10 V, 0/4-20 mA PT100, PT1000, 2- or 3-wire connection KTY83, KTY84, NTC

Motor control and protection

Technical data



Ethernet communication interfaces

Mounted in the MCC cable chamber; connection of 1 to 4 motor controllers UMC100.3 via simple cables

MTQ22	for Modbus TCP
PNQ22	for Profinet IO



Fieldbus communication interfaces

Can be mounted direct on the UMC100.3 or separate in the cable chamber of the MCC. Connection for standard fieldbus cables with 9-pole Sub-D (Profibus DP) or terminal blocks

PDP32	for Profibus DP
DNP31	for DeviceNet
MRP31	for Modbus RTU



CEM11 earth leakage sensors

Summation current transformer for connecting to a digital input
Mounting with bracket on DIN busbar or wall
Models

CEM11-FBP.20	80 – 1.700 mA	20 mm Ø
CEM11-FBP.35	100 – 3.400 mA	35 mm Ø
CEM11-FBP.60	120 – 6.800 mA	60 mm Ø
CEM11-FBP.120	300 – 13.600 mA	120 mm Ø

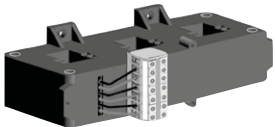

Current transformer CT4L / CT5L

Only required for rated motor currents >63 A
Linear transformer, 3-phase with terminal block, designed for connecting leads Cu 2.5 mm²



UMC100-PAN control panel

Installation on the device or on the switching cabinet door
Graphics-enabled and backlit display, 3 LEDs for status indication
Freely configurable error messages
USB port for PC connection
Multilingual: German, English, French, Italian, Polish, Portuguese, Spanish, Russian

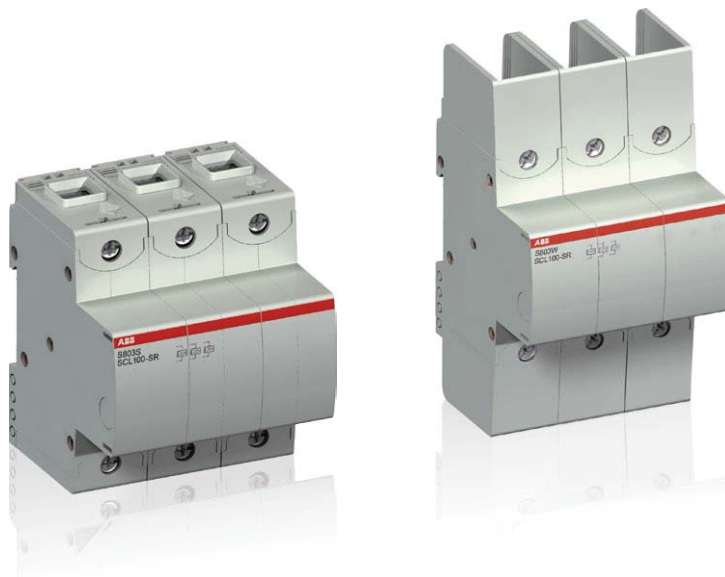

Self resetting current limiting module

S800-SCL-SR

Ordering details	11/2
Technical data	11/3

S800-SCL-SR

Self-resetting current limiting module



2CCS413389F001

S800S-SCL-SR



2CCS4133181R001

S803W-SCL-SR

Description

S800-SCL-SR is ABB's innovative self-resetting current limiting module which considerably increases the short-circuit breaking capacity of downstream manual motor starters and high performance MCBs. S800-SCL-SR is a self resetting current limiting module based on the S800 technology.

It limits the short-circuit current until the downstream means of protection trips. Its current continuity makes it as the ideal solution for group protection: All parallel branches remain operative. This leads to an Expanded application range of the low voltage switchgear whose short-circuit capabilities are usually limited. S800-SCL-SR can be combined with S800S high performance MCB or with manual motor starters. S800-SCL-SR can also back up a single circuit breaker or a group of circuit breakers or motor starters (group protection). Terminals and outside dimensions are identical to the S800 range.

Ordering details

Self-resetting short-circuit limiter IEC version [A]	Type designation	Product number	EAN number	Weight [kg]	Pack. unit
			7612271		
1-pole					
32	S801S-SCL32-SR	2CCS801901R0539	412012	0.25	1
63	S801S-SCL63-SR	2CCS801901R0599	412036	0.25	1
100	S801S-SCL100-SR	2CCS801901R0639	411992	0.25	1
2-pole					
32	S802S-SCL32-SR	2CCS802901R0539	412074	0.5	1
63	S802S-SCL63-SR	2CCS802901R0599	412098	0.5	1
100	S802S-SCL100-SR	2CCS802901R0639	412050	0.5	1
3-pole					
32	S803S-SCL32-SR	2CCS803901R0539	411930	0.75	1
63	S803S-SCL63-SR	2CCS803901R0599	411947	0.75	1
100	S803S-SCL100-SR	2CCS803901R0639	411954	0.75	1

Self-resetting short-circuit limiter IEC/UL version [A]	Type designation	Product number	EAN number	Weight [kg]	Pack. unit
			7612271		
3-pole					
32	S803W-SCL32-SR	2CCS803917R0539	412319	0.75	1
63	S803W-SCL63-SR	2CCS803917R0599	412326	0.75	1
100	S803W-SCL100-SR	2CCS803917R0639	412302	0.75	1

Main dimensions mm, inches

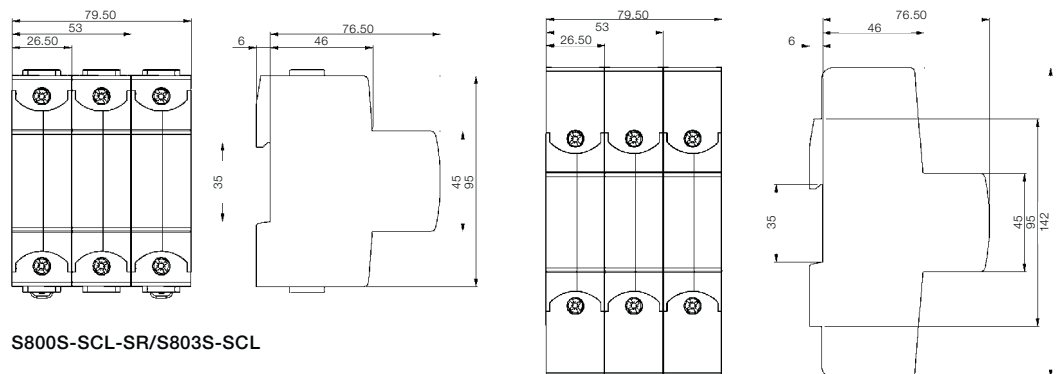

S800S-SCL-SR/S803S-SCL

S803W-SCL-SR

2CCS413012B0201

S800S-SCL-SR/S803W-SCL-SR

Technical data

		S800S-SCL-SR	S803W-SCL-SR
Rated operational current I_e	[A]	32, 63, 100	32, 63, 100
Pole		1, 2, 3	3
Rated operational voltage U_e			
(AC) according to IEC 60947-2	50/60 Hz [V]	400/690	690
(AC) according to UL 508	50/60 Hz [V]		600
Rated insulation voltage U_i	[V]	690	690
Rated impulse withstand voltage U_{imp}	[kV]	8	8
Rated ultimate short-circuit breaking capacity			
$I_{cu} = I_{cs}$ according to IEC 60947-2*			
(AC) 50/60 Hz 240/415 V	[kA]	100	100
(AC) 50/60 Hz 254/440 V	[kA]	100	100
(AC) 50/60 Hz 277/480 V	[kA]	65	65
(AC) 50/60 Hz 289/500 V	[kA]	65	65
(AC) 50/60 Hz 346/600 V	[kA]	65	65
(AC) 50/60 Hz 400/690 V	[kA]	50	50
Short-circuit rating according to UL 508, CSA 22.2*			
(AC) 50/60 Hz 480 V	[kA]	65	65
(AC) 50/60 Hz 600 V	[kA]	65	65
*) Valid only for approved combinations			
Rated frequency	[Hz]	50/60	50/60
Mounting position		any	any
Connections C_u			
	[mm ²]	1 ... 50 rigid (solid/stranded)	1 ... 50 rigid (solid/stranded)
	[mm ²]	1 ... 70 flexible	1 ... 70 flexible
			14–1 AWG
Tightening torque			
	[Nm]	min. 3/max. 4	min. 3/max. 4
	[in. lbs.]		min. 26.5/max. 25
Feeding		optional	optional
Mouting on DIN top hat rail		EN 60715	EN 60715
Ambient air temperature	[°C]	-40 ... +70	-40 ... +70
Storage temperature	[°C]	-40 ... +85	-40 ... +85
Degree of protection		IP20	IP20
Classification acc. to NF F 16-101, NF F 16-102		I3, F2	I3, F2
Damp Heat		IEC 60068-2-30, 55 °C / 95 % r.h.	IEC 60068-2-30, 55 °C / 95 % r.h.
Vibration		IEC 60068-2-6, 5–10 Hz / 3 mm and 10–500 Hz / 2 g at 0.5 x I_e	IEC 60068-2-6, 5–10 Hz / 3 mm and 10–500 Hz / 2 g at 0.5 x I_e
Random Vibration		IEC 60068-2-64, 5–500 Hz / 2 g at 0.5 x I_e	IEC 60068-2-64, 5–500 Hz / 2 g at
0.5 x I_e			
Resistance to climatic conditions		IEC 60068-2-1 / -2-2 / -2-30	IEC 60068-2-1 / -2-2 / -2-30
Standard		IEC 60947-2 IEC 60947-4-1	IEC 60947-2 IEC 60947-4-1 UL 508, CSA 22.2 No. 14

11

Internal resistance at 25°C ambient temperature and nominal power losses

Rated current I_n	Internal resistance R_i	Power losses P_{vn}
[A]	[mΩ/pole]	[W/pole]
32	2.8	3.6
63	1.3	5.7
100	0.7	7.8

Influence of ambient temperature – single mounted devices

Rated current I_n [A]	10°C	15°C	20°C	25°C	30°C	35°C	40°C	45°C	50°C	55°C	60°C	65°C	70°C
32	38.2	37.2	35.8	35.2	34.2	33.3	32	30.7	29.8	28.8	27.8	26.5	25.1
63	75.3	73.2	70.6	69.3	67.4	65.5	63	60.5	58.6	56.7	54.8	52.3	49.8
100	119.5	116.2	112	110	107	104	100	96	93	90	87	84	80

20CC413012B0201

S800-SCL-SR

Technical data

Short circuit breaking capacity

	S800S-SCL-SR	S803W-SCL-SR
Rated ultimate short-circuit breaking capacity		
I_{cu} = I_{cs} according to IEC 60947-2		
(AC) 50/60 Hz 240/415 V	[kA] 100	100
(AC) 50/60 Hz 254/440 V	[kA] 100	100
(AC) 50/60 Hz 277/480 V	[kA] 65	65
(AC) 50/60 Hz 289/500 V	[kA] 65	65
(AC) 50/60 Hz 346/600 V	[kA] 65	65
(AC) 50/60 Hz 400/690 V	[kA] 50	50
Short-circuit rating according to UL 508, CSA 22.2		
(AC) 50/60 Hz 480 V	[kA]	65
(AC) 50/60 Hz 600 V	[kA]	65

Coordination

Type	230V AC					400V AC					440V AC					
	I _{cs} kA	I _{cu} kA	Fuse gG, aM kA A	Current Limiter S803x-SCL-SR kA A		I _{cs} kA	I _{cu} kA	Fuse gG, aM kA A	Current Limiter S803x-SCL-SR kA A		I _{cs} kA	I _{cu} kA	Fuse gG, aM kA A	Current Limiter S803x-SCL-SR kA A		
MS132-0.16																
MS132-0.25																
MS132-0.4																
MS132-0.63																
MS132-1.0	No back-up required					No back-up required					No back-up required					
MS132-1.6																
MS132-2.5											20	20	100	35	100	32, 63,100
MS132-4.0											20	20	100	63	100	32, 63,100
MS132-6.3											20	20	100	100	100	32, 63,100
MS132-10											20	20	100	100	100	32, 63,100
MS132-12											20	20	100	125	100	32, 63,100
MS132-16											20	20	100	125	100	32, 63,100
MS132-20											20	20	100	125	100	32, 63,100
MS132-25	50	50	100	125	100	63,100					50	50	100	125	100	63,100
MS132-32	25	50	100	125	100	63,100					25	50	100	125	100	63,100

Type	500 V AC							690 V AC						
	I _{cs} kA	I _{cu} kA	Fuse gG, aM kA A	Current Limiter S803x-SCL-SR kA A				I _{cs} kA	I _{cu} kA	Fuse gG, aM kA A	Current Limiter S803x-SCL-SR kA A			
MS132-0.16														
MS132-0.25														
MS132-0.4														
MS132-0.63														
MS132-1.0	No back-up required							No back-up required						
MS132-1.6														
MS132-2.5	20	20	100	35	65*	32, 63,100		3	3	80	35	50**	32, 63,100	
MS132-4.0	20	20	100	63	65*	32, 63,100		3	3	80	63	50**	32, 63,100	
MS132-6.3	20	20	100	100	65*	32, 63,100		3	3	80	100	50**	32, 63,100	
MS132-10	20	20	100	100	65*	32, 63,100		3	3	80	100	50**	32, 63,100	
MS132-12	20	20	100	125	65*	32, 63,100		3	3	80	125	50**	32, 63,100	
MS132-16	20	20	100	125	65*	32, 63,100		3	3	80	125	50**	32, 63,100	
MS132-20	20	20	100	125	65*	32, 63,100		3	3	80	125	50**	32, 63,100	
MS132-25	10	10	100	125	65*	63,100		3	3	80	125	50**	63,100	
MS132-32	10	10	100	125	65*	63,100		3	3	80	125	50**	63,100	

* 100 kA on request

** 80 kA on request

S800-SCL-SR and S803S-SCL

Technical data

Installation requirements

The total sum of the rated currents of all downstream motor starters or circuit breakers shall not exceed the rated current of the S800-SCL-SR. Furthermore the sum of all load currents including inrush currents shall not exceed the maximum permissible load of the S800-SCL-SR.

Maximum load

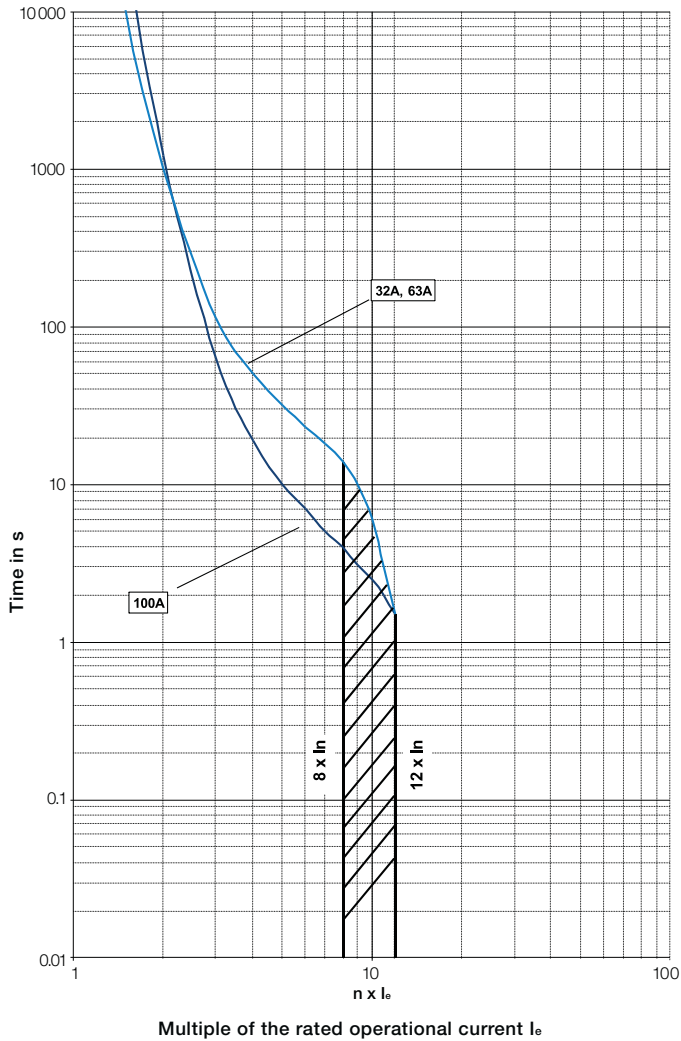

Certifications and approvals

General technical data

Certifications and approvals 12/2

General technical data

Coordination with short-circuit protection devices	12/8
Standards, specifications and certifying organizations	12/10
Terms and technical definitions	12/12
Standards and utilization categories	12/14
North American standards and utilization categories	12/16
Degrees of protection	12/17
Climatic withstand of devices	12/18

Certifications and approvals

Designed according to the appropriate specifications, the devices in this catalogue have been built and tested. They can be used in most countries without any further certifications.

Some countries, however, require certification according to their own national standards. In other cases, the Marine for example, approvals ratifying that particular specifications have been met are necessary.

The table below shows the approvals and certifications for different devices.













The following documents may be obtained on request:

- Certificates of conformity
- Certificates of certification or approval.

The use of certified devices does not exonerate the equipment supplier from complying with the legal specifications of the country concerned.













Explanation of symbols:

■ **Standard design approved**, the company labels bear the certification mark when this is required.

Mark	Certifications					Approvals: ship classification societies							
													
Abbreviation	CSA	UL	cULus	CCC	GOST or EAC	BV	GL	LR	DNV	RINa	ABS	RMRS	CCS
Approved in	Canada	USA	North America	China	Russia	France	Germany	Gr.Britain	Norway	Italy	USA	Russia	China shipping
3-pole contactors													
4 to 7.5 kW													
AC operated AS09, AS12, AS16			■ E312527	■	■								
DC operated ASL09, ASL12, ASL16			■ E312527	■	■								
4 to 45 kW													
AC / DC operated AF09, AF12, AF16, AF26, AF30, AF38			■ E312527	■	■	■	■ (3)	■	■ (3)	■	■	■	■
AC / DC operated AF40, AF52, AF65, AF80, AF96			■ E312527	■	■	■	■ (3)	■	■ (3)	■	■	■	■
55 to 200 kW													
AC / DC operated (2) AF116, AF140, AF146			■ E36588	■	■	■	■	■	■	■	■	■ (1)	■
AC / DC operated (2) AF190, AF205, AF265, AF305, AF370			■ E36588	■	■	■	■	■	■	■	■	■ (1)	■
200 to 560 kW													
AC / DC operated AF400, AF460, AF580, AF750			■ E36588	■	■	■	■	■	■	■	■	■	■
AC / DC operated AF1250			■ E73397	■	■	■	■	■	■	■	■	■	■
AC / DC operated AF1350, AF1650			■ E36588	■	■	■	■	■	■	■	■	■	■
AC / DC operated AF2050			■ E73397	■	■	■	■	■	■	■	■	■	■
AC / DC operated AF2650			■ E73397	■	■	■	■	■	■	■	■	■	■
4-pole contactors													
25 to 125 A, AC-1													
AC / DC operated AF09, AF16, AF26, AF38			■ E312527	■	■	■	■ (3)	■	■ (3)	■	■	■	■
AC / DC operated AF40, AF52, AF80			■ E312527	■	■ (1)	■				■			
160 to 525 A, AC-1													
AC / DC operated AF116, AF140, AF190, AF205, AF265, AF305, AF370			■ E73397		■ (1)	■	■ (1)	■	■				
800 to 1000 A AC-1													
AC operated EK550			■ E36588	■	■	■							
AC operated EK1000				■	■	■							
DC operated EK550			■ E36588	■	■	■							
DC operated EK1000				■	■	■							

(1) in progress. (2) Marine approvals for AF116 ... AF370 with built-in PLC interface: only DNV is available. (3) DNV-GL certificate.
All AF contactors are  (RCM) marked.







Certifications and approvals









Mark	Certifications					Approvals: ship classification societies							
	 CSA Canada	 UL USA	 cULus North America	 CCC China	 GOST or EAC Russia	 BV France	 GL Germany	 LR Gr. Britain	 DNV Norway	 RINA Italy	 ABS USA	 RMRS Russia	 CCS China shipping
DC switching contactors													
AC operated GA75	■	■ E319322		■									
DC operated GAE75	■	■ E319322		■									
AC / DC operated GAF185 ... GAF300			■ E73397	■									
AC / DC operated GAF460, GAF750, GAF1250, GAF1650, GAF2050			■ E73397	■									
Capacitor switching contactors													
AC operated UA16		■ E312527		■	■								
AC operated UA26 ... UA75	■	■ E312527		■	■								
AC operated UA95, UA110			■ E36588	■	■								
AC operated UA16..RA ... UA75..RA		■ E312527		■	■								
AC operated UA95..RA, UA110..RA			■ E36588	■	■								
Contactor relays													
AC operated 4-pole, 8-pole - NS..			■ E252354	■	■								
DC operated 4-pole, 8- pole - NSL..			■ E252354	■	■								
AC / DC operated 4-pole, 8-pole - NF..			■ E252354	■	■	■	■	■	■	■	(1)	■	

(1) in progress.

All GAF and NF contactors are  (RCM) marked.

Certifications and approvals

	Certifications					
Mark						
Abbreviation	CSA	UL	cULus	CCC	GOST or EAC	
Approved in	Canada	USA	North America	China	Russia	

Approvals: ship classification societies							
							
BV	GL	LR	DNV	RINa	ABS	RMRS	CCS
France	Germany	Gr.Britain	Norway	Italy	USA	Russia	China shipping

Accessories for AS09 ... AS16 contactors

Accessory	CSA	UL	cULus	CCC	GOST or EAC
Auxiliary contacts					
CA3			■ E252354	■	■
Mechanical interlock unit					
VM3			■ E312527		■
Connecting links					
BEA16-3			■ E312527		■
BEA16-3U			■ E312527		
BER16C-3			■ E312527		■
BEY16C-3			■ E312527		■
Electronic timer					
TEF3			■ E252354		■
Surge suppressors					
RT5			■ E312527		■
RC5-1			■ E312527		■
RV5			■ E312527		■

Accessory	BV	GL	LR	DNV	RINa	ABS	RMRS	CCS
CA3								
VM3	□	□	□	□	□	□	□	□
BEA16-3	□	□	□	□	□	□	□	□
BEA16-3U	□	□	□	□	□	□	□	□
BER16C-3	□	□	□	□	□	□	□	□
BEY16C-3	□	□	□	□	□	□	□	□
TEF3								
RT5								
RC5-1								
RV5								













Accessories for AF09 ... AF2650 and EK contactors and NF contactor relays

Accessory	CSA	UL	cULus	CCC	GOST or EAC
Auxiliary contacts					
CA4, CC4			■ E252354	■	■
CAT4			■ E252354	■	■
CAL4			■ E252354	■	■
CAL19			■ E76003	■	■
CAL18			■ E76003	■	■
CAL16			■ E76003	■	■
CE5...D0.1		■ E319322		■	■
CE5...D2		■ E319322		■	■
CE5...W0.1		■ E319322		■	■
CE5...W2		■ E319322			■
CEL18			■ E76003		■
Electronic timer					
TEF4			■ E252354		■
Mechanical / electrical interlock unit					
VEM4			■ E312527	■	■
Mechanical interlock units					
VM4, VM96-4			■ E312527		■
VM19			■ E36588		■
VM140/190			■ E36588		■
VM205/265			■ E36588		■
VM 750			■ E36588		■
VM1650H			■ E36588		■
Interface relay					
RA4			■ E252354		■

Accessory	BV	GL	LR	DNV	RINa	ABS	RMRS	CCS
CA4, CC4	■ (CA4)	■ (CA4)	■	■ (CA4)	■	■	■	
CAT4	■	■	■	■	■	■	■	
CAL4	■	■	■	■	■	■	■	
CAL19	■	■	■	■	■	■	■	■
CAL18	■	■	■	■	■	■	■	■
CAL16								
CE5...D0.1								
CE5...D2								
CE5...W0.1								
CE5...W2								
CEL18								
TEF4								
VEM4								
VM4, VM96-4	□	□	□	□	□	□	□	□
VM19	□	□	□	□	□	□	□	□
VM140/190	□	□	□	□	□	□	□	□
VM205/265	□	□	□	□	□	□	□	□
VM 750	□	□	□	□	□	□	□	□
VM1650H	□	□	□	□	□	□	□	□
RA4								













□ Marine approvals not needed for this accessory.

Certifications and approvals

Mark	Certifications					Approvals: ship classification societies							
	 CSA Canada	 UL USA	 cULus North America	 CCC China	 GOST or EAC Russia	 BV France	 GL Germany	 LR Gr.Britain	 DNV Norway	 RINA Italy	 ABS USA	 RMRS Russia	 CCS China shipping
Latching unit WB75-A		<input checked="" type="checkbox"/>	E252354		<input checked="" type="checkbox"/>								
Connecting links with manual motor starters BEA16-4, BEA26-4, BEA38-4, BEA65-4			<input checked="" type="checkbox"/>	E312527	<input checked="" type="checkbox"/>	<input type="checkbox"/>	<input type="checkbox"/>	<input type="checkbox"/>	<input type="checkbox"/>	<input type="checkbox"/>	<input type="checkbox"/>	<input type="checkbox"/>	<input type="checkbox"/>
Connection sets for reversing contactors BER16-4, BER38-4			<input checked="" type="checkbox"/>	E312527	<input checked="" type="checkbox"/>	<input type="checkbox"/>	<input type="checkbox"/>	<input type="checkbox"/>	<input type="checkbox"/>	<input type="checkbox"/>	<input type="checkbox"/>	<input type="checkbox"/>	<input type="checkbox"/>
BER65-4, BER96-4			<input checked="" type="checkbox"/>	E312527	<input checked="" type="checkbox"/>	<input type="checkbox"/>	<input type="checkbox"/>	<input type="checkbox"/>	<input type="checkbox"/>	<input type="checkbox"/>	<input type="checkbox"/>	<input type="checkbox"/>	<input type="checkbox"/>
BER140-4, BER205-4, BER370-4			<input checked="" type="checkbox"/>	E36588	<input checked="" type="checkbox"/>	<input type="checkbox"/>	<input type="checkbox"/>	<input type="checkbox"/>	<input type="checkbox"/>	<input type="checkbox"/>	<input type="checkbox"/>	<input type="checkbox"/>	<input type="checkbox"/>
BEM460-30, BEM750-30			<input checked="" type="checkbox"/>	E36588	<input checked="" type="checkbox"/>	<input type="checkbox"/>	<input type="checkbox"/>	<input type="checkbox"/>	<input type="checkbox"/>	<input type="checkbox"/>	<input type="checkbox"/>	<input type="checkbox"/>	<input type="checkbox"/>
Connection sets for star-delta starters BEY16-4, BEY38-4			<input checked="" type="checkbox"/>	E312527	<input checked="" type="checkbox"/>	<input type="checkbox"/>	<input type="checkbox"/>	<input type="checkbox"/>	<input type="checkbox"/>	<input type="checkbox"/>	<input type="checkbox"/>	<input type="checkbox"/>	<input type="checkbox"/>
BEY65-4, BEY96-4			<input checked="" type="checkbox"/>	E312527	<input checked="" type="checkbox"/>	<input type="checkbox"/>	<input type="checkbox"/>	<input type="checkbox"/>	<input type="checkbox"/>	<input type="checkbox"/>	<input type="checkbox"/>	<input type="checkbox"/>	<input type="checkbox"/>
BEY190-4, BEY205-4, BEY265-4, BEY370-4			<input checked="" type="checkbox"/>	E36588	<input checked="" type="checkbox"/>	<input type="checkbox"/>	<input type="checkbox"/>	<input type="checkbox"/>	<input type="checkbox"/>	<input type="checkbox"/>	<input type="checkbox"/>	<input type="checkbox"/>	<input type="checkbox"/>
BED460, BED580, BED750			<input checked="" type="checkbox"/>	E36588	<input checked="" type="checkbox"/>	<input type="checkbox"/>	<input type="checkbox"/>	<input type="checkbox"/>	<input type="checkbox"/>	<input type="checkbox"/>	<input type="checkbox"/>	<input type="checkbox"/>	<input type="checkbox"/>
Phase to phase connections BEP140-30, BEP205-30, BEP370-30			<input checked="" type="checkbox"/>	E36588	<input checked="" type="checkbox"/>	<input type="checkbox"/>	<input type="checkbox"/>	<input type="checkbox"/>	<input type="checkbox"/>	<input type="checkbox"/>	<input type="checkbox"/>	<input type="checkbox"/>	<input type="checkbox"/>
BEP140-40, BEP205-40, BEP370-40			<input checked="" type="checkbox"/>	E36588	<input checked="" type="checkbox"/>	<input type="checkbox"/>	<input type="checkbox"/>	<input type="checkbox"/>	<input type="checkbox"/>	<input type="checkbox"/>	<input type="checkbox"/>	<input type="checkbox"/>	<input type="checkbox"/>
BES460, BES750			<input checked="" type="checkbox"/>	E36588	<input checked="" type="checkbox"/>	<input type="checkbox"/>	<input type="checkbox"/>	<input type="checkbox"/>	<input type="checkbox"/>	<input type="checkbox"/>	<input type="checkbox"/>	<input type="checkbox"/>	<input type="checkbox"/>
Connection bars between contactors and MCCB BEA140/XT2			<input checked="" type="checkbox"/>	E36588	<input checked="" type="checkbox"/>	<input type="checkbox"/>	<input type="checkbox"/>	<input type="checkbox"/>	<input type="checkbox"/>	<input type="checkbox"/>	<input type="checkbox"/>	<input type="checkbox"/>	<input type="checkbox"/>
BEA205/XT4			<input checked="" type="checkbox"/>	E36588	<input checked="" type="checkbox"/>	<input type="checkbox"/>	<input type="checkbox"/>	<input type="checkbox"/>	<input type="checkbox"/>	<input type="checkbox"/>	<input type="checkbox"/>	<input type="checkbox"/>	<input type="checkbox"/>
BEA370/T5			<input checked="" type="checkbox"/>	E36588	<input checked="" type="checkbox"/>	<input type="checkbox"/>	<input type="checkbox"/>	<input type="checkbox"/>	<input type="checkbox"/>	<input type="checkbox"/>	<input type="checkbox"/>	<input type="checkbox"/>	<input type="checkbox"/>
Terminal connecting strips and shorting bars LY16-4, LY38-4			<input checked="" type="checkbox"/>	E312527	<input checked="" type="checkbox"/>	<input type="checkbox"/>	<input type="checkbox"/>	<input type="checkbox"/>	<input type="checkbox"/>	<input type="checkbox"/>	<input type="checkbox"/>	<input type="checkbox"/>	<input type="checkbox"/>
LY110, LY185, LY300, LY460, LY750			<input checked="" type="checkbox"/>	E36588	<input checked="" type="checkbox"/>	<input type="checkbox"/>	<input type="checkbox"/>	<input type="checkbox"/>	<input type="checkbox"/>	<input type="checkbox"/>	<input type="checkbox"/>	<input type="checkbox"/>	<input type="checkbox"/>
LP185, LP300, LP460, LP750			<input checked="" type="checkbox"/>	E36588	<input checked="" type="checkbox"/>	<input type="checkbox"/>	<input type="checkbox"/>	<input type="checkbox"/>	<input type="checkbox"/>	<input type="checkbox"/>	<input type="checkbox"/>	<input type="checkbox"/>	<input type="checkbox"/>
LH38-4			<input checked="" type="checkbox"/>	E312527	<input checked="" type="checkbox"/>	<input type="checkbox"/>	<input type="checkbox"/>	<input type="checkbox"/>	<input type="checkbox"/>	<input type="checkbox"/>	<input type="checkbox"/>	<input type="checkbox"/>	<input type="checkbox"/>
LF16-4, LF38-4			<input checked="" type="checkbox"/>	E312527	<input checked="" type="checkbox"/>	<input type="checkbox"/>	<input type="checkbox"/>	<input type="checkbox"/>	<input type="checkbox"/>	<input type="checkbox"/>	<input type="checkbox"/>	<input type="checkbox"/>	<input type="checkbox"/>
LG16-4			<input checked="" type="checkbox"/>	E312527	<input checked="" type="checkbox"/>	<input type="checkbox"/>	<input type="checkbox"/>	<input type="checkbox"/>	<input type="checkbox"/>	<input type="checkbox"/>	<input type="checkbox"/>	<input type="checkbox"/>	<input type="checkbox"/>
LK96-4			<input checked="" type="checkbox"/>	E312527	<input checked="" type="checkbox"/>	<input type="checkbox"/>	<input type="checkbox"/>	<input type="checkbox"/>	<input type="checkbox"/>	<input type="checkbox"/>	<input type="checkbox"/>	<input type="checkbox"/>	<input type="checkbox"/>
Additional coil terminal blocks LD38-4			<input checked="" type="checkbox"/>	E312527	<input checked="" type="checkbox"/>	<input type="checkbox"/>	<input type="checkbox"/>	<input type="checkbox"/>	<input type="checkbox"/>	<input type="checkbox"/>	<input type="checkbox"/>	<input type="checkbox"/>	<input type="checkbox"/>
Additional terminal blocks LDC4			<input checked="" type="checkbox"/>	E312527	<input checked="" type="checkbox"/>	<input type="checkbox"/>	<input type="checkbox"/>	<input type="checkbox"/>	<input type="checkbox"/>	<input type="checkbox"/>	<input type="checkbox"/>	<input type="checkbox"/>	<input type="checkbox"/>
Protective covers BX4, BX4-CA			<input checked="" type="checkbox"/>	E252354	<input checked="" type="checkbox"/>	<input type="checkbox"/>	<input type="checkbox"/>	<input type="checkbox"/>	<input type="checkbox"/>	<input type="checkbox"/>	<input type="checkbox"/>	<input type="checkbox"/>	<input type="checkbox"/>
Terminal shrouds LT65-30 ... LT96-30			<input type="checkbox"/>		<input type="checkbox"/>	<input type="checkbox"/>	<input type="checkbox"/>	<input type="checkbox"/>	<input type="checkbox"/>	<input type="checkbox"/>	<input type="checkbox"/>	<input type="checkbox"/>	<input type="checkbox"/>
LT52-40 ... LT80-40			<input type="checkbox"/>		<input type="checkbox"/>	<input type="checkbox"/>	<input type="checkbox"/>	<input type="checkbox"/>	<input type="checkbox"/>	<input type="checkbox"/>	<input type="checkbox"/>	<input type="checkbox"/>	<input type="checkbox"/>
LT140 ... LT750			<input checked="" type="checkbox"/>	E36588	<input checked="" type="checkbox"/>	<input type="checkbox"/>	<input type="checkbox"/>	<input type="checkbox"/>	<input type="checkbox"/>	<input type="checkbox"/>	<input type="checkbox"/>	<input type="checkbox"/>	<input type="checkbox"/>
LT140-40 ... LT370-40			<input checked="" type="checkbox"/>	E73397	<input checked="" type="checkbox"/>	<input type="checkbox"/>	<input type="checkbox"/>	<input type="checkbox"/>	<input type="checkbox"/>	<input type="checkbox"/>	<input type="checkbox"/>	<input type="checkbox"/>	<input type="checkbox"/>
Terminal enlargement LW			<input checked="" type="checkbox"/>	E36588	<input checked="" type="checkbox"/>	<input type="checkbox"/>	<input type="checkbox"/>	<input type="checkbox"/>	<input type="checkbox"/>	<input type="checkbox"/>	<input type="checkbox"/>	<input type="checkbox"/>	<input type="checkbox"/>

Marine approvals not needed for this accessory.













Certifications and approvals

Mark	Certifications						Approvals: ship classification societies						
	 CSA Canada	 UL USA	 cULus North America	 CCC China	 GOST or EAC Russia	 EAC Russia	 BV France	 GL Germany	 LR Gr. Britain	 DNV Norway	 RINA Italy	 ABS USA	 RMRS Russia
Terminal extension													
LX			■ E36588		■	□	□	□	□	□	□	□	□
Connection socket													
LL			■ E36588		■	□	□	□	□	□	□	□	□
Connection modules													
LD146-30, LD146-40			■ E36588		■	□	□	□	□	□	□	□	□
Function marker													
BA4			■ E252354			□	□	□	□	□	□	□	□
Fixing clip													
BB4			■ E312527			□	□	□	□	□	□	□	□
Manual motor starters													
MS116			■ E137861	■	■		■ (1)	■	■	■	■	■	■
MS132			■ E137861 E345003	■	■	■	■	■	■	■	■	■	■
MS165			■ E137861 E345003	■									
MS495	■	■	■ E167205 E195536	■	■	■	■	■	■	■	■	■	■
MS497	■	■	■ E167205 E195536	■	■	■	■	■	■	■	■	■	■
Manual motor starters magnetic only													
MO132			■ E137861 E345003	■	■		■	■	■	■	■	■	■
MO165			■ E137861 E345003	■									
MO495	■	■	■ E167205	■	■	■	■	■	■	■	■	■	■
MO496	■	■	■ E167205	■	■	■	■	■	■	■	■	■	■
Circuit breaker for transformer protection													
MS132-T				■									
Mini contactors													
3-pole contactors													
AC operated B6, B7			■ E191658	■	■		■	■	■	■	■	■	■
DC operated BC6, BC7, B7D			■ E191658	■	■		■	■	■	■	■	■	■
DC operated B6S, B7S			■ E191658	■	■		■	■	■	■	■	■	■
3-pole reversing contactors													
AC operated VB6, VB7			■ E191658	■	■		■	■	■	■	■	■	■
DC operated VBC6, VBC7			■ E191658	■	■		■	■	■	■	■	■	■
AC operated VB6A, VB7A			■ E191658	■	■		■	■	■	■	■	■	■
DC operated VBC6A, VBC7A			■ E191658	■	■		■	■	■	■	■	■	■
3-pole interface contactors													
DC operated BC6, BC7			■ E191658	■	■		■	■	■	■	■	■	■
3-pole contactor - large coil voltage range													
DC operated TBC7													

(1) MS116 up to 16 A only.

□ Marine approvals not needed for this accessory.

Certifications and approvals

Mark	Certifications						Approvals: ship classification societies						
	 CSA Canada	 UL USA	 cULus North America	 CCC China	 GOST or EAC Russia	 ATEX	 BV France	 GL Germany	 LR Gr. Britain	 DNV Norway	 RINa Italy	 ABS USA	 RMRS Russia
4-pole contactors													
AC operated B6, B7			■ E191658	■	■		■	■	■	■			■
DC operated BC6, B7D			■ E191658	■	■		■	■	■				■
4-pole contactor - large coil voltage range													
DC operated TBC7													
Contactor relays													
AC operated K6			■ E48139	■	■								■
DC operated KC6			■ E48139	■	■								■
Interface contactor relays													
DC operated KC6			■ E48139	■	■								■
DC operated K6S			■ E48139	■	■								■
Contactor relays - large coil voltage range													
DC operated TKC6													
Thermal overload relays													
T16			■ E48139	■	■		■	■	■	■	■	■	■
TF42			■ E48139	■	■		■	■	■	■	■	■	■
TF65			■ E48139	■	■		■	■	■	■	■	■	■ (3)
TF96			■ E48139	■	■		■	■	■	■	■	■	■ (3)
TF140DU			■ E48139	■	■		■	■	■	■	■	■	■
TF140DU-V1000			■ E48139	■	■		■	■	■	■	■	■	■
TA200DU			■ E48139	■	■		■	■	■	■	■	■	■
TA200DU-V1000			■ E48139	■	■		■	■	■	■	■	■	■
Electronic overload relays													
0.10...45 A													
E16DU			■ E48139	■	■								■
EF19			■ E48139	■	■		■	■	■	■	■	■	■
EF45			■ E48139	■	■		■	■	■	■	■	■	■
20...150 A													
EF65			■ E48139	■	■		■	■	■	■	■	■	■
EF96			■ E48139	■	■		■	■	■	■	■	■	■ (2)
EF146			■ E48139	■	■		■	■	■	■	■	■	■
63...380 A													
EF205			■ E48139	■	■		■	■	■	■	■	■	■
EF370			■ E48139	■	■		■	■	■	■	■	■	■
150...800 A													
EF460			■ E48139	■	■		■	■	■	■	■	■	■
EF750			■ E48139	■	■		■	■	■	■	■	■	■
150...1250 A													
E1250DU			■ E76003										■

(2) EF65-56 has no RINa approval and ATEX certification is valid for EF65-56 produced from week 47, 2015. (3) ATEX is valid for products produced from week 26, 2015. All electronic overload relays are  (C-Tick) marked.

Coordination with short-circuit protection devices

In compliance with standards IEC 60947-4-1 and EN 60947-4-1, we define for the contactors and starters the type, rating and characteristics of the short-circuit protection devices SCPD which allow selective protection against overloads and ensure protection against short circuits.

Basic functions

Any starter is designed to:

- start motors,
- ensure continuous functioning of motors,
- disconnect motors from the supply line,
- guarantee protection of motors against overloads.

The starter is typically made up of a switching device (contactor) and an overload protection device (thermal overload relay or electronic overload relay).

These two devices MUST be coordinated with equipment capable of providing protection against short circuit (SCPD: short circuit protective device): typically a circuit breaker with magnetic release only or a switch fuse. These are not necessarily part of the starter.

Applicable standards

IEC 60947-4-1 (EN 60947-4-1) precisely defines the different points to be considered in order to carry out correct coordination.

Complete coordination for a combination includes the following points:

- Selectivity test between the overload relay and the short-circuit protection device SCPD.
- Short-circuit condition tests:
 - at prospective "r" currents - These currents depend on the rated operational current of the starter (**I_e** AC-3) and are given by the standard (Table 13). For example:
 - r = 1kA for **I_e** AC-3 < 16 A
 - r = 3 kA for 16 A < **I_e** AC-3 < 63 A
 - r = 5 kA for 63 A < **I_e** AC-3 < 125 A etc.
 - at the rated conditional short-circuit current "**I_q**" - This is the maximum prospective current that the combination can withstand, for example 50 kA.

Types of coordination

IEC 60947-4-1 (EN 60947-4-1) defines two types of coordination according to the expected level of service continuity. Acceptable extreme damage for the switchgear is divided into two types.

Type 1: In short-circuit conditions, the contactor or starter does not endanger persons or installations and will not be able to then operate without being repaired or having parts replaced.

Type 2: In short-circuit conditions, the contactor or starter does not endanger persons or installations and will be able to operate afterwards. The risk of contacts light welding is acceptable. In this case, the manufacturer must stipulate the measures to be taken with respect to maintenance of the equipment.

The complete ABB offer

ABB has acquired years of experience with respect to problems of coordination and is able to make a complete offer based on tests performed in its qualified laboratories. This offer includes 400 V, 500 V, 690 V networks.

A complete data base of coordination tables, according to IEC 60947-4-1 (EN 60947-4-1), is available on the ABB Website.

In the coordination tables the following short-circuit protection devices are recommended:

- Moulded case circuit-breakers (MCCBs)
- Miniature circuit-breakers (MCBs)
- Switch-disconnector-fuses (aM, gG and BS)
- Manual Motor Starters (MMS).

General remarks applicable to all tables

- Each table is defined for a maximum ambient temperature of 40 °C. For higher temperatures, apply a derating factor according to the following rules:
 - Fuses: factor of 0.8 applied to **I_n** for an ambient temperature of 70 °C
 - MCCBs and MCBs: factor of 0.8 applied to **I_n** for an ambient temperature of 60 °C
 - The starter derating factor depends on the operating conditions of thermal overload relays:
 - Factor of 0.9 applied to **I_n** for an ambient temperature of 70 °C.
- Each table is defined for motor currents: 3-phase motors, 4-pole
- **Normal starting** means a starting time < 2 s. - **Difficult starting** means an accelerating time 10 s < **t_s** < 30 s
- **Tripping classes** of thermal overload relays according to IEC 60947-4-1 (EN 60947-4-1): 10A and 10
- **Tripping classes** of electronic overload relays according to IEC 60947-4-1 (EN 60947-4-1): 10E, 20E, 30E selectable
- In the tables with MCCBs, these are fitted with the magnetic relay alone. Setting is always carried out at > 12.3 **I_e** AC-3 so that the transient current peak occurring during starting does not lead to tripping.

Coordination with short-circuit protection devices

A complete data base of coordination tables, according to [IEC 60947-4-1](#) (EN 60947-4-1) or [UL 508 / UL 60947-4-1](#), is available on the ABB Website: see below.

Selection

Simple or multiple selections all from the same screen.

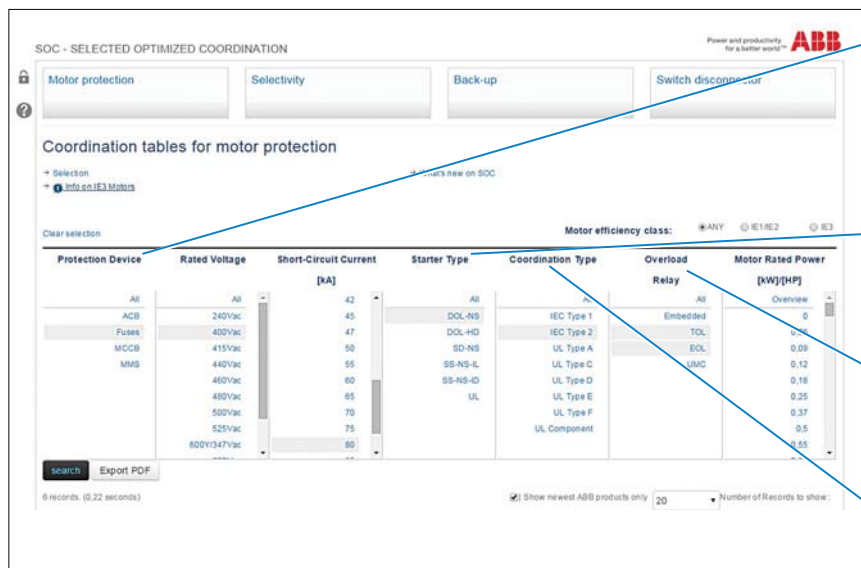

Short-circuit protection devices

- Air circuit breakers
- Fuses "gG" or "aM"
- Miniature circuit breaker
- Moulded case circuit breaker
- Manual motor starter

Starter type

- Direct-on-line normal start
- Direct-on-line heavy duty
- Star-delta normal start
- Soft starter normal start

Overload relay

- TOL : thermal overload relay
- EOL : electronic overload relay
- UMC : Universal motor controller

Coordination

- IEC type 1 or type 2
- UL type A to Type F

Results

- Search results displayed at the bottom of the selection page.
- Only the most appropriate solutions to your application, will be displayed at the bottom of the page.
- "Enable Smart Current Search" function featured for the short-circuit current where "near to" selected values also are included in the result.
- Possible to print the page to a pdf file or from your printer.
- "Clear selection" function to deselect all selected.

Fuses, 400 Vac, 100 kA, DOL-NS, Coordination Type IEC Type 2, Overload Relay TOL, Motor efficiency class IE1 + IE2									
Motor	Fuses IEC			Contactor	Overload Relay		Max allowed load current [A]	Table	
	Rated Power [kW]	Rated Current [A]	Switch-Fuse Type		Rating gG/aM [A]	Type and Size			
0.25	0.85	0632GD_	2	CFAF 600aM	AF09	TF42-1.0	0.74 - 1.00	1.00	⇒
0.12	0.44	0632GD_	2	CFAF 600H	AF09	TF42-0.55	0.42 - 0.55	0.55	⇒

Fuses, 400 Vac, 100 kA, DOL-NS, Coordination Type IEC Type 2, Overload Relay EOL, Motor efficiency class IE3									
Motor	Fuses IEC			Contactor	Overload Relay		Max allowed load current [A]	Table	
	Rated Power [kW]	Rated Current [A]	Switch-Fuse Type		Rating gG/aM [A]	Type and Size			
0.16	0.60	0632GD_	2	CFAF 600aM	AF09	EF19-1.0 10*	0.30 - 1.00		⇒
0.12	0.44	0632GD_	2	CFAF 600H	AF09	EF19-1.0 10*	0.30 - 1.00		⇒
0.12	0.44	0632GD_	2	CFAF 600H	AF09	EF19-1.0 10*	0.30 - 1.00	0.54	⇒
0.16	0.60	0632GD_	2	CFAF 600aM	AF09	EF19-1.0 10*	0.30 - 1.00	1.00	⇒



Access
To find the coordination tables for motor protection, please see:
<http://applications.it.abb.com/SOC/Page/Selection.aspx>

Standards, specifications and certifying organizations

Definitions

ABB low voltage devices are developed and manufactured in accordance with the applicable regulations as stated in the international IEC standards, the European EN standards and the national ones such as NF, DIN, GB and BS. For devices installed in ships, an approval issued by independent classification societies is demanded by the maritime insurance companies.

CB scheme

Certification Body certificates (CB certificates) are available to prove the complete conformity to standards

The IEC CB (Certification Body) scheme is multilateral agreement between the National Certification Bodies to allow international certification of electrical and electronic products so that a single certification allows worldwide market access.

The CB Scheme was established by the International Electrotechnical Committee for conformity testing to standards for electrical equipment (IECEE).

Certified products

In some cases, products are validated and tested according to a standard by a certification body and the manufacturer is regularly visited by this body in order to check the respect of the design and the materials used. This process creates a certified product. This is the case of UL (Underwriters Laboratories) and CSA (Canadian Standard Association) for instance (see below).

Specifications

International Specifications

The International Electrotechnical Commission, IEC, which is part of the International Standards Organization, ISO, publishes IEC publications which act as a basis for the world market.

European Specifications and National Specifications

The European committee for electrotechnical standardization (CENELEC), which groups together European countries, publishes EN standards.

These European standards may differ very little from IEC international standards and have similar numbering.

The same applies for national standards which use, without exception, the same numbering and reproduce the texts of these unified standards in their entirety. Contradicting national standards are withdrawn.

European Directives

The guarantee of the free movement of goods within the European Community means that any regulatory differences between member states have been eliminated. The European directives set up common rules that are included in the legislation of each state while contradictory regulations are cancelled.

Three directives are essential:

- **Low Voltage Directive** 2006/95/EC (until April 2016, 19th) and 2014/35/EC (from April 2016, 20th) concerns electrical equipment from 0 to 1000 V AC and from 0 to 1500 V DC.

This specifies that compliance with the requirements that it sets out is acquired if the equipment conforms to the standards harmonized on an European level. EN 60947-1 and EN 60947-4-1 for contactors.

- **Machinery Directive** 2006/42/EC for safety specifications of machines and equipment on complete machines.

- **Electromagnetic Compatibility Directive** 2004/108/EC (until April 2016, 19th) and 2014/30/EC (from April 2016, 20th) which concerns all devices able to create electromagnetic disturbance.

CE Marking:

CE marking indicates that the marked equipment conforms to the relevant EU directive.

CE marking is part of an administrative procedure and guarantees free movement of the product within the European Community.

Standards in Canada and the USA

Canadian and American specifications are more or less equivalent but differ greatly from IEC standards.

UL Underwriters Laboratories USA

CSA Canadian Standard Association Canada

UL (USA) specifications make the following distinction between devices:

Listed Product

A product that has been produced under UL's listing and follow-up service program in accordance with the terms of UL's service agreement and that bears the UL listing mark as the manufacturer's declaration that the product complies with UL's requirements.

Recognized Component

A part or subassembly covered under UL's recognition service and intended for factory installation in listed (or other) products. Recognized components are incomplete in certain construction features or restricted in performance capabilities and not intended for separate installation in the field, rather they are intended for use as components of incomplete equipment submitted for investigation by UL. Final acceptance of the component in the complete equipment is dependent upon its installation and use in accordance with all applicable use conditions and ratings noted in the component report issued by UL, in the guide information and in the individual client's Recognized Component information page.

The combined UL signs for the USA and Canada are recognized by the authorities of both countries.

Compulsory China Certification (CCC): The CCC mark is a compulsory certification mark in the field of safety for products sold on the Chinese market.

GOST / EAC: Russia (please consult your local ABB sales office)

C-Tick: The C-Tick mark certifies compliance with the Australian EMC requirements. The mark is also recognized in New Zealand

ANCE: Mexico

Marine Approvals

The following specifications must be respected when these devices are used on ships:

Standards, specifications and certifying organizations

BV	Bureau Veritas France
DNV	Det Norske Veritas Norway
GL	Germanischer Lloyd Germany
LRS	Lloyd's Register of Shipping Great Britain
ABS	America Bureau of Shipping
RMRS	Russian Maritime Register of Shipping RMRS
RRR	Russian River Register
MRS	Maritime Register of Shipping Russia
PRS	Polski Rejestr Statkow Poland
RINA	Registro Italiano Navale Italy

National Standards

European countries national standards reproduce the corresponding EN... standards. Codification is built by addition of a prefix to EN numbering.

For instance:

- France **NF** EN...
- Germany **DIN** EN...
- Great Britain **BS** EN...
- Italy **CEI** EN...
- Sweden **SS** EN...

Specifications (cont.)

International Standards

IEC 60947-1 Low-voltage switchgear and controlgear – Part 1: General rules

IEC 60947-4-1 Low-voltage switchgear and controlgear – Part 4: Contactors and motor starters – Section 1: Electromechanical contactors and motor starters

IEC 60947-5-1 Low-voltage switchgear and controlgear – Part 5: Control circuit devices and switching elements – Section 1: Electromechanical control circuit devices

IEC 60947-5-4 Low-voltage switchgear and controlgear – Part 5-4: Control circuit devices and switching elements. Method of assessing the performance of low-energy contacts. Special tests

IEC 60947-6-1 Low-voltage switchgear and controlgear – Part 6: Multiple function equipment – Section 1: Automatic transfer switching equipment

IEC 60204-1 Electrical equipment of industrial machines – Part 1: General requirements

IEC 60715 Dimensions of low-voltage switchgear and controlgear. Standardized mounting on rails for mechanical support of electrical devices in switchgear and controlgear installations

European Standards

EN 50 005 Low-voltage switchgear and controlgear for industrial use – Terminal marking and distinctive number: General rules
(Annex L of IEC 60947-1).

EN 50 011 Low-voltage switchgear and controlgear for industrial use – Terminal marking, distinctive number and distinctive letter for particular contactor relays (Annex M of IEC 60947-5-1)

EN 60947-1 Low-voltage switchgear and controlgear – Part 1: General rules.

EN 60947-4-1 Low-voltage switchgear and controlgear – Part 4: Contactors and motor starters – Section 1: Electromechanical contactors and motor starters.

EN 60947-5-1 Low-voltage switchgear and controlgear – Part 5: Control circuit devices and switching elements – Section 1: Electromechanical control circuit devices.

EN 60947-5-4 Low-voltage switchgear and controlgear – Part 5-4: Control circuit devices and switching elements. Method of assessing the performance of low-energy contacts. Special tests.

EN 60947-6-1 Low-voltage switchgear and controlgear – Part 6: Multiple function equipment – Section 1: Automatic transfer switching equipment.

EN 60204-1 Electrical equipment of industrial machines – Part 1: General requirements.

EN 60 715 Dimensions of low-voltage switchgear and controlgear. Standardized mounting on rails for mechanical support of electrical devices in switchgear and controlgear installations.

Terms and technical definitions

Circuits

- auxiliary circuit: All the conductive parts of a contactor designed to be inserted in a different circuit from the main circuit and the contactor control circuits.
- control circuit: All the conductive parts of a contactor (other than the main circuit and the auxiliary circuit) used to control the contactor's closing operation or opening operation or both.
- main circuit: All the conductive parts of a contactor designed to be inserted in the circuit that it controls.

Thermal overload relay tripping classes

IEC 60947-4-1 defines tripping classes 10 A, 10, 20 and 30. Types 10 A, 10, etc. correspond to the maximum tripping time for a making current at 7.2 times the setting current.

Furthermore, for each class the standard specifies the tripping time for 1.5 times the setting current and sets the non tripping condition at 1.05 times the setting current.

All these data are summarized in the table below.

Extract from IEC 60947-4-1:

Tripping class	10 A	10	20	30
Max. tripping time for 1.5 times the setting current (warm state)	s 120	240	480	720
Tripping time for 7.2 times the setting current (cold state)	s 2 - 10	4 - 10	6 - 20	9 - 30
For 1.05 times the setting current	No tripping			

Electromagnetic compatibility

AF... contactors comply with IEC 60947-1, 60947-4-1 and EN 60947-1, 60947-4-1 standards.

Definitions:

Environment A: "Mainly relates to low-voltage non public or industrial networks/locations/installations (EN 50082-2 article 4) including highly disturbing sources".

Environment B: "Mainly relates to low-voltage public networks (EN 50082-1 article 5) such as residential, commercial and light industrial locations/installations. Highly disturbing sources such as arc welders are not covered by this environment".

Notice for AF09...AF2650 contactors:

- AF09 ... AF38 contactors and NF contactor relays (produced since week 08-2013), AF40 ... AF96 contactors have been designed for environment B.
- AF09 ... AF38...-12 contactors and NF.E-12 contactor relays (48...130 V 50/60 Hz-DC), AF116 ... AF2650 contactors: these products have been designed for environment A. Use of this product in environment B may cause unwanted electromagnetic disturbances in which case the user may be required to take adequate mitigation measures.

Note: for 48...130 V 50/60 Hz-DC in environment B, AF09 ... AF38...-22 contactor or NF.E-22 contactor relays can be selected.

Definitions according to SEMI F47-0706

SEMI F47-0706 defines the voltage sag immunity required for semiconductor processing, metrology and automated test equipment, and on subsystems and components which are used in the construction of semiconductor processing equipment including but not limited to:

- Power supplies
- Generators
- Robots and factory interface
- Chillers, pumps, blowers
- AC operated contactors and contactor relays...

voltage sag: an rms reduction in the AC voltage, at the power frequency, for durations from a half cycle to a few seconds.

The IEC terminology for this phenomenon is voltage dip.

voltage sag immunity: the ability of equipment to withstand momentary electrical power interruptions or sags.

Coordination of protections against short circuit

The goal here is to protect electromechanical starters and softstarters.

Any starter is designed to:

- start motors,
- ensure continuous functioning of motors,
- disconnect motors from the supply line,
- guarantee protection of motors against overloads.

The starter is typically made up of a switching device (contactor) and an overload protection device (thermal overload relay or electronic overload relay). These two devices MUST be coordinated with equipment capable of providing protection against short circuit (SCPD: short circuit protective device): typically a circuit breaker with magnetic release only or a switch fuse. These are not necessarily part of the starter.

The characteristics of the starter must comply with the international standard IEC 60947-4-1 which defines the above items as follows:

contactor: a mechanical switching device having only one position of rest, operated otherwise than by hand, capable of making, carrying and breaking currents under normal circuit conditions including overload conditions.

overload release: overload relay or release which operates in the case of overload and also in case of loss of phase.

circuit-breaker: defined by IEC 60947-2 as a mechanical switching device, capable of making, carrying and breaking currents under normal circuit conditions and also making, carrying for a specified time and breaking currents under specified abnormal circuit conditions.

IEC publication 60947-4-1 defines coordination types "1" and "2":

- Type "1" coordination requires that, in the event of a short-circuit, the contactor or starter does not endanger persons or installations and will not then be able to operate without being repaired or parts being replaced.
- Type "2" coordination requires that, in short-circuit conditions, the contactor or starter does not endanger persons or installations and will be able to operate afterwards. The risk of contacts being light welded is acceptable. In this case, the manufacturer must stipulate the measures to be taken with respect to maintenance of the equipment.

Rated operational current I_e .

Current rated by the manufacturer. It is mainly based on the rated operational voltage U_e , the rated frequency, the utilization category, the rated duty and the type of protective enclosure, if necessary.

Conventional free air thermal current I_{th}

Current that the contactor can withstand in free air for a duty time of 8 hours without the temperature rise of its various parts exceeding the maximum values given by the standard.

Operating cycle or cycle

Includes one making operation and one breaking operation.

Cycle time

This is the sum of the current flow time and the no-current time for given cycle.

Terms and technical definitions

Electrical durability

Number of on-load operating cycles that the contactor is able to carry out. It depends on the operational current, the operational voltage and the utilization category.

Mechanical durability

Number of no-current operating cycles that a contactor is able to carry out.

Assessed failure rate

Defined according to IEC 60947-5-4. This rate is given in standard industrial environments for the contactor relays and for the built-in auxiliary contact of contactors.

Load factor

Ratio of the on-load operating time to the total cycle time x 100.

Switching frequency

Number of switching cycles per hour.

Plugging

Stopping or fast reversal in rotation direction of a motor by two supply leads being interchanged while the motor is running.

Inching

Energization of a motor's circuit repeatedly or for short periods with the aim of obtaining small movements of the driven mechanism.

Coil operating limits

Expressed in multiples of the nominal control circuit voltage U_c for the upper and lower limits.

Mounting position

Comply with the manufacturer's instructions. Restrictions are to be taken into account for certain mounting positions.

Rated breaking or making capacity

Root mean square (r.m.s.) value of the current that the contactor is able to break or make at a given voltage according to the conditions specified by standards and for a given utilization category.

Intermittent duty

Duty during which the contactor is successively closed or open for periods which are too short to enable the contactor to achieve thermal balance.

Ambient temperature

Air temperature close to the contactor.

Time

- Time constant: Ratio of the inductance to the resistance ($L/R = \text{mH}/\Omega = \text{ms}$).
- Short-time withstand current: Current that the contactor is able to withstand in closed position for a short time interval and in specified conditions.
- Closing time: Time interval between the coil energization and the instant the contacts touch on all the poles.

- Opening time: Time interval between the coil de-energization and the instant the contacts separate on all the poles.

Rated control voltage U_c

Control voltage value for which the control circuit is sized.

Rated operational voltage U_e

Voltage to which the contactor's utilization characteristics refer. In three-phase it is the phase-to-phase voltage.

Rated insulation voltage U_i

Reference voltage for dielectric tests and creepage distances.

Rated impulse withstand voltage U_{imp}

Peak value of an impulse voltage, having a specified form and polarity, which does not cause breakdown in specific test conditions.

Shock withstand

Requirement for vehicles, crane drives, installations on board ships and plug-in equipment. For the acceptable "g" values, the contacts must not change position and the thermal overload relays must not trip.

Resistance to vibrations

Requirements for vehicles, boats and other means of transport. For the specified vibration amplitude and frequency values the device must remain able to operate.

Mirror contacts

Definitions of mirror contact acc. to IEC 60947-4-1, Annex F 2.1. Normally closed auxiliary contact (N.C.) which cannot be in the closed position simultaneously with the normally open (N.O.) main contact.

Mechanically linked contact

Definitions of mechanically linked elements acc. to IEC 60947-5-1, Annex L.

Combination of "n" Make auxiliary contact element(s) and "m" Break auxiliary contact element(s) are designed in such a way that they cannot be in the closed position simultaneously.

One control circuit device may have more than one group of mechanically linked contact elements.

Standards and utilization categories

Utilization categories

A contactor's duty is characterised by the utilization category together with the rated operational voltage and current indicated.

Utilization categories for contactors according to IEC 60947-4-1:

Alternating current:	AC-1	Non-inductive or slightly inductive loads, resistance furnaces.
	AC-2	Slip-ring motors: starting, switching off.
	AC-3	Cage motors: starting, switching off running motors.
	AC-4	Cage motors: starting, plugging, inching.
	AC-5a	Discharge lamp switching.
	AC-5b	Incandescent lamp switching.
	AC-6a	Transformer switching.
	AC-6b	Capacitor bank switching.
	AC-8a	Hermetic refrigeration compressor motor control with manual resetting of overload releases.
	AC-8b	Hermetic refrigeration compressor motor control with automatic resetting of overload releases.
Direct current:	DC-1	Non inductive or slightly inductive loads, resistance furnaces.
	DC-3	Shunt motors: starting, plugging, inching, dynamic breaking of DC motors.
	DC-5	Series motors: starting, plugging, inching, dynamic breaking of DC motors.
	DC-6	Incandescent lamp switching.

Utilization categories for contactor relays according to IEC 60947-5-1:

Alternating current:	AC-12	Control of resistive loads and static loads with opto-coupler isolation.
	AC-13	Control of static loads with transformer isolation.
	AC-14	Control of weak electromagnetic loads ($\leq 72 \text{ VA}$).
	AC-15	Control of electromagnetic loads ($> 72 \text{ VA}$).
	Direct current:	DC-12
DC-13		Control of DC electromagnets.
DC-14		Control of DC electromagnets having economy resistors.

In fact some applications, and the specific criteria characterizing the various loads controlled by contactors, may modify the utilization characteristics of the contactors. The main applications concerned are:

Capacitor bank switching

Account must be taken of high peaks when the current is made and of harmonic currents during continuous duty. For this application, IEC publication 60947-4-1 stipulates utilization category AC-6b. The operational currents or powers acceptable for the contactors are determined by our electrical tests; IEC publication 60947-4-1 gives the calculating formula for determining the operational current (Table 9).

Transformer switching

Account must be taken of the peaks due to magnetization phenomena when the current is made.

For this application, IEC publication 60947-4-1 stipulates utilization category AC-6a. The operational currents or powers acceptable for the contactors are determined using the values obtained for AC-3 or AC-4 category tests and the calculating formula given in IEC 60947-4-1 (Table 9).

Lighting circuit switching

The current peaks occurring on energization of the circuit and the power factor depend on the type of lamps, the connection mode and whether or not there is compensation.

For this application, IEC publication 60947-4-1 stipulates two standard utilization categories:

- AC-5a for discharge lamp switching.
- AC-5b for incandescent lamp switching.

Slip-ring motor switching

The contactors used for short-circuiting rotor resistors can be used for rotor voltages up to 2 times the rated operational voltage.

The conditions of use of rotor contactors depend on the connection mode of the main poles. IEC 60947-4-1 stipulates AC-2 utilization category for starter contactor.

Standards and utilization categories

Utilization categories (cont.)

DC power circuit switching

Arc suppression is more difficult in direct current than in alternating current. Higher the time constant and voltage, heavier the breaking conditions: consequently several poles have to be connected in series.

AC high current circuit switching

Possibility of increasing performances by connecting poles in parallel.

Circuit switching during temporary and intermittent duty

In these cases higher operational currents are acceptable.

Influence of the length of the conductors used in the contactor control circuit

According to the operational voltages, the cross-sectional areas, the coil consumption and the control layout, difficulties due to line resistances and capacitances may appear during contactor closing and opening orders.

Making and breaking conditions for utilization categories

Utilization category	Durability test conditions						Occasional operation					
	Making conditions			Breaking conditions			Making and breaking capacities - 50 operating cycles			Making and breaking capacities - 50 operating cycles		
	I/le	U/Ue	Cos. φ or L/R (ms)	I/le	U/Ue	Cos. φ or L/R (ms)	Ic/le	Ur/Ue	Cos. φ or L/R (ms)	Ic/le	Ur/Ue	Cos. φ or L/R (ms)

Contactors for AC circuit switching

AC-1		1	1	0.95	1	1	0.95	1.5	1.05	0.8	1.5	1.05	0.8
AC-2		2.5	1	0.65	2.5	1	0.65	4	1.05	0.65	4	1.05	0.65
AC-3	le < 17 A	6	1	0.65	1	0.17	0.65	10	1.05	0.45	8	1.05	0.45
	17 < le < 100 A	6	1	0.35	1	0.17	0.35	10	1.05	0.45	8	1.05	0.45
	le > 100 A	6	1	0.35	1	0.17	0.35	10	1.05	0.35	8	1.05	0.35
AC-4	le < 17 A	6	1	0.65	6	1	0.65	12	1.05	0.45	10	1.05	0.45
	17 < le < 100 A	6	1	0.35	6	1	0.35	12	1.05	0.45	10	1.05	0.45
	le > 100 A	6	1	0.35	6	1	0.35	12	1.05	0.35	10	1.05	0.35

Contactors for DC circuit switching

DC-1		1	1	1	1	1	1	1.5	1.05	1	1.5	1.05	1
DC-3		2.5	1	2	2.5	1	2	4	1.05	2.5	4	1.05	2.5
DC-5		2.5	1	7.5	2.5	1	7.5	4	1.05	15	4	1.05	15

Contactors for AC circuit switching

AC-14	(≤ 72 VA)	-	-	-	-	-	-	6	1.1	0.7	6	1.1	0.7
AC-15	(> 72 VA)	10	1	0.7	1	1	0.4	10	1.1	0.3	10	1.1	0.3

Contactors for AC circuit switching

Utilization category	Standard operation						Occasional operation						
	Making conditions			Breaking conditions			Making and breaking capacities - 50 operating cycles			Making and breaking capacities - 50 operating cycles			
	I/le	U/Ue	T _{0.95}	I/le	U/Ue	T _{0.95}	Ic/le	Ur/Ue	T _{0.95}	Ic/le	Ur/Ue	T _{0.95}	
DC-13		1	1	6 P(1)	1	1	6 P(1)	1.1	1.1	6 P(1)	1.1	1.1	6 P(1)
DC-14		-	-	-	-	-	-	10	1.1	15 ms	10	1.1	15 ms

(1) The value "6 x P" is the result of an empirical relation which is estimated to represent most DC magnetic loads up to the highest limit of P = 50 W (6 x P = 300 ms). It is accepted that loads having drawn energy above 50 W are made up of weaker loads in parallel. As a consequence, the 300 ms value must form the highest limit whatever the value of the power drawn.

Key:

U (I) = applied voltage (current)

Ur = recovery voltage

L/R = test circuit time constant

Ue (Ie) = rated operational voltage (current)

Ic = making and breaking current expressed in DC or in AC like the r.m.s. value of the symmetrical components

T_{0.95} = time required to reach 95 % of the current in steady-state conditions, expressed in milliseconds

North American standards and utilization categories

Depending on the utilization category or intended rating for a contactor, North American standards require two main tests: an endurance test to simulate conventional device making and breaking capacity over its lifetime, and an overload test to simulate periodic conditions demanding higher making and breaking capacity than is conventional for the application. The test setups differ in regards to current, power factor, and number of electrical operating cycles.

The tables below provide a comparison of the types of load testing for contactors rated up to 100 A.

AC load testing for contactors rated up to 100 A

Harmonized test			Rating designation	Endurance (conventional) test			Overload (conditional) test			Required load marking
IEC	UL	CSA		Multiple of current	Power factor	Number of cycles	Multiple of current	Power factor	Number of cycles	
General use, non-inductive or slighting inductive loads, resistance furnaces and heaters										
■	■	■	AC-1: general use	1	0.8	6000	1.5	0.8	50	-
	■	■	AC resistance	1	1	6000	1.5	1	50	"Resistive"
	■	■	AC resistance air heating	1	1	100 000	1.5	1	50	"Resistance"
		■	AC electrical heating control	1	1	250 000	1.5	1	50	-
Motor loads										
■	■	■	AC-2: slip-ring motors	2	0.65	6000	4	0.65	50	-
■			AC-3: squirrel cage motors	2	0.45	6000	10 for make 8 for make break	0.45	50 make + 50 make break	-
	■	■	AC motor (across-the-line switching)	2	0.40 – 0.50	1000	LRA (~6)	0.40 – 0.50	50	-
	■	■	Elevator control, AC motor	2	0.50	500 000	n/a	n/a	n/a	"Elevator duty"
■	■	■	AC-4: plugging, inching, jogging	6	0.45	6000	12 for make 10 for make break	0.45	50 make + 50 make break	-
Lamps and lighting loads										
■	■	■	AC-5a: electric discharge lamps	2	0.45	6000	3	0.45	50	"Ballast"
■	■	■	AC-5b: incandescent lamps	1	Lamp	6000	1.5	Lamp	50	"Tungsten"
Transformers and capacitors										
■			AC-6a: transformers	The manufacturer shall verify the AC-6a rating by testing with a transformer, or may derive the rating from the values for AC-3.						
■			AC-6b: capacitors	Capacitive ratings may be derived by capacitor switching tests or assigned on the basis of established practice and experience.						
	■	■	Capacitive switching (kVar)	1	Capacitor	6000	1.5	Capacitor	50	-
Hermetic refrigerant compressor motors										
■	■	■	AC-8a: hermetic refrigerant compressor	1	0.8	30 000	6	0.45	50	"Hermetic refrigeration compressor"
■	■	■	AC-8b: hermetic refrigerant compressor (recycle rating)	6	0.45	6000	6	0.45	50	-

Note: the information above is an overview of UL 60947-4-1 tables 1, 7, 10, 5.4.1DV.1.1, 8.2.4.1DV.1.1, and 8.2.4.2DV.1.1 and is intended for comparison purposes only.

DC load testing for contactors rated up to 100 A

Harmonized test			Rating designation	Endurance test			Overload test			Required load marking
IEC	UL	CSA		Multiple of current	L/R ms	Number of cycles	Multiple of current	L/R ms	Number of cycles	
General use, non-inductive or slighting inductive loads, resistance furnaces and heaters										
■	■	■	DC-1: general use	1	1	6000	1.5	1	50	-
	■	■	DC resistance	1	1	6000	1.5	1	50	"Resistive"
	■	■	DC resistance air heating	1	1	100 000	1.5	1	50	"Resistance"
Motor loads										
■			DC-3: shunt motors	2.5	2	6000	4	2.5	50	-
	■	■	DC motor (across-the-line switching)	2	n/a	1000	10	n/a	50	-
	■	■	Elevator control, DC motor	2	n/a	500 000	Not applicable			"Elevator duty"
■			DC-5: series motors	2.5	7.5	6000	4	15	50	-
Lamps and lighting loads										
■	■	■	DC-6: incandescent lamps	1	Lamp	6000	1.5	Lamp	50	"Tungsten"

Note: the information above is an overview of UL 60947-4-1 tables 1, 7, 10, 5.4.1DV.1.1, 8.2.4.1DV.1.1, and 8.2.4.2DV.1.1 and is intended for comparison purposes only.

Degrees of protection

General

In an installation, the degree of protection required for electrical equipment depends on the environmental characteristics. The degree of protection, ensured by the enclosure of equipment or by the cubicle containing the equipment is expressed by the IP code which gives the level of protection against access to hazardous parts, the ingress of foreign bodies and/or the ingress of water, in compliance with IEC 60529, IEC 60947-1.

Besides the IP symbol, the complete code has two figures followed (optionally) by two additional letters. A short description of the elements used in IP coding is given below.

IP... code	Figures or letters	Specifications for installation protection	Protection of persons
First figure		Against ingress of foreign bodies	Against access to hazardous parts with:
	0	No protection	No protection
	1	Diameter > 50 mm	Back of hand
	2	Diameter > 12.5 mm	Finger
	3	Diameter > 2.5 mm	Tool
	4	Diameter > 1 mm	Wire
	5	Limited protection against dust	Wire
	6	Total protection against dust	Wire
Second figure		Against entrance of water having a harmful effect	
	0	No protection	
	1	Vertical dripping	
	2	Dripping at a vertical angle of < 15°	
	3	Rain at a vertical angle of < 60°	
	4	Splashing	
	5	Low pressure water jet	
	6	Powerful water jets	
	7	Temporary immersion	
	8	Permanent immersion	
Additional letter (optional) for use with:		Against ingress of foreign bodies	Against access to hazardous parts with:
First figure 0	A	Stopped by a barrier with a 50 mm Ø sphere	Back of hand
First figure 0 or 1	B	Entrance of test finger limited to 80 mm	Finger
First figure 1 or 2	C	Wire with 2.5 mm Ø and length of 100 mm	Tool
First figure 2 or 3	D	Wire with 1 mm Ø and length of 100 mm	Wire
Additional letter (optional)		Specific additional information	
	H	High voltage apparatus	-
	M	Moving parts which are moving during water test	
	S	Moving parts which are stationary during water test	
	W	Specified atmospheric conditions	

Note: The type of enclosure or cubicle in which the equipment must be installed prevails with respect to the degree of protection.

Climatic withstand of devices

The life time of devices are mainly influenced by series of climatic factors which cause their corrosion.

In practice, besides climatic conditions, there are other factors which may damage equipment such as fungi, insects (termites), dust, work site dirt and aggressive environment (salty or sulphurous atmosphere, etc.) which can often only be identified at the place of installation.

Climatic stress, definitions and test conditions are dealt with in national publications such as the DIN 50 series and UTE 63-100 publication which are attached to international publications such as IEC 60068.

The test conditions are:

Description	Symbolization	Time of one cycle	Cycle phase time	Temperature in test chamber	Relative humidity
Humidity and variable temperature	IEC 60068-2-30 Test Db	24 hours	12 hours including rise in temperature	40 °C	95 %
			12 hours including cooling (open device)	25 °C	95 %

ABB contactors have been used for many years in the most countries, with hot and humid climates for example: Brazil, Indonesia, India or on ships. Experience has shown that ABB devices can be used in most countries throughout the world.

The climate of the country in which the apparatus is installed is not the determining choice factor.

Account must be taken of:

- the immediate environment of the devices (sheltered, ventilated, temperature),
- the aggressivity of the immediate atmosphere at the place of installation,
- the length and frequency of non operating periods.

In the case of frequent condensation (i.e. the formation of condensation caused by rapid changes in temperature), heating resistors must be installed in cubicles (100 to 250 W per m³ of enclosure).

The table below gives the cases where heating is necessary.

Environment		Operating conditions	Climate	Internal heating of enclosure
Inside premises	No running water no condensation	Continuous or not	All climates	Without
		Continuous	All climates	Without
	With running water	Frequent or long stops	Temperate Tropical	Without With
Outside, sheltered	No running water no condensation	Continuous or not	Temperate	Without
			Tropical	With
Outside or by the seaside	With running water	Continuous	All climates	Without
			Frequent or long stops	Temperate Tropical

The entrance of dust, insects, dirt, etc. in devices may be prevented if the appropriate degree of protection according to IEC 60529 is chosen (See "Degree of protection" table).

Notes

A series of horizontal dotted lines for taking notes, spanning the width of the page.

Index

Order code classification

Order code	Type	Page	Order code	Type	Page	Order code	Type	Page
1SAM101923R0002	MSMN	2/47	1SAM250005R1013	MS116-20-HKF1-11	2/6	1SAM451000R1012	MS165-20	2/8
1SAM101923R0012	MSMNO	2/47	1SAM250005R1014	MS116-25-HKF1-11	2/6	1SAM451000R1013	MS165-25	2/8
1SAM201901R1001	HKF1-11	2/23	1SAM250005R1015	MS116-32-HKF1-11	2/6	1SAM451000R1014	MS165-32	2/8
1SAM201901R1002	HKF1-20	2/23	1SAM301901R1001	CK1-11	2/23	1SAM451000R1015	MS165-42	2/8
1SAM201901R1003	HKF1-10	2/23	1SAM301901R1002	CK1-20	2/23	1SAM451000R1016	MS165-54	2/8
1SAM201901R1004	HKF1-01	2/23	1SAM301901R1003	CK1-02	2/23	1SAM451000R1017	MS165-65	2/8
1SAM201902R1001	HK1-11	2/23	1SAM340000R1001	MS132-0.16T	2/11	1SAM461000R1011	MO165-16	2/10
1SAM201902R1002	HK1-20	2/23	1SAM340000R1002	MS132-0.25T	2/11	1SAM461000R1012	MO165-20	2/10
1SAM201902R1003	HK1-02	2/23	1SAM340000R1003	MS132-0.4T	2/11	1SAM461000R1013	MO165-25	2/10
1SAM201902R1004	HK1-20L	2/23	1SAM340000R1004	MS132-0.63T	2/11	1SAM461000R1014	MO165-32	2/10
1SAM201903R1001	SK1-11	2/23	1SAM340000R1005	MS132-1.0T	2/11	1SAM461000R1015	MO165-42	2/10
1SAM201903R1002	SK1-20	2/23	1SAM340000R1006	MS132-1.6T	2/11	1SAM461000R1016	MO165-54	2/10
1SAM201903R1003	SK1-02	2/23	1SAM340000R1007	MS132-2.5T	2/11	1SAM461000R1017	MO165-65	2/10
1SAM201904R1001	UA1-24	2/24	1SAM340000R1008	MS132-4.0T	2/11	1SAM501901R1001	KA495	2/44
1SAM201904R1002	UA1-48	2/24	1SAM340000R1009	MS132-6.3T	2/11	1SAM501902R1001	KA495C	2/44
1SAM201904R1003	UA1-60	2/24	1SAM340000R1010	MS132-10T	2/11	1SAM550000R1007	MS495-63	2/32
1SAM201904R1004	UA1-110	2/24	1SAM340000R1011	MS132-16T	2/11	1SAM550000R1008	MS495-75	2/32
1SAM201904R1005	UA1-230	2/24	1SAM340000R1012	MS132-12T	2/11	1SAM550000R1009	MS495-90	2/32
1SAM201904R1006	UA1-400	2/24	1SAM340000R1013	MS132-20T	2/11	1SAM550000R1010	MS495-100	2/32
1SAM201904R1007	UA1-415	2/24	1SAM340000R1014	MS132-25T	2/11	1SAM560000R1007	MO495-63	2/37
1SAM201904R1008	UA1-208	2/24	1SAM350000R1001	MS132-0.16	2/7	1SAM560000R1008	MO495-75	2/37
1SAM201904R1009	UA1-575	2/24	1SAM350000R1002	MS132-0.25	2/7	1SAM560000R1009	MO495-90	2/37
1SAM201904R1010	UA1-20	2/24	1SAM350000R1003	MS132-0.4	2/7	1SAM560000R1010	MO495-100	2/37
1SAM201906R1102	PS1-2-0-65	2/28	1SAM350000R1004	MS132-0.63	2/7	1SAM580000R1004	MS497-32	2/32
1SAM201906R1103	PS1-3-0-65	2/28	1SAM350000R1005	MS132-1.0	2/7	1SAM580000R1005	MS497-40	2/32
1SAM201906R1104	PS1-4-0-65	2/28	1SAM350000R1006	MS132-1.6	2/7	1SAM580000R1006	MS497-50	2/32
1SAM201906R1105	PS1-5-0-65	2/28	1SAM350000R1007	MS132-2.5	2/7	1SAM580000R1007	MS497-63	2/32
1SAM201906R1112	PS1-2-1-65	2/28	1SAM350000R1008	MS132-4.0	2/7	1SAM580000R1008	MS497-75	2/32
1SAM201906R1113	PS1-3-1-65	2/28	1SAM350000R1009	MS132-6.3	2/7	1SAM580000R1009	MS497-90	2/32
1SAM201906R1114	PS1-4-1-65	2/28	1SAM350000R1010	MS132-10	2/7	1SAM580000R1010	MS497-100	2/32
1SAM201906R1115	PS1-5-1-65	2/28	1SAM350000R1011	MS132-16	2/7	1SAM590000R1004	MO496-32	2/37
1SAM201906R1122	PS1-2-2-65	2/28	1SAM350000R1012	MS132-12	2/7	1SAM590000R1005	MO496-40	2/37
1SAM201906R1123	PS1-3-2-65	2/28	1SAM350000R1013	MS132-20	2/7	1SAM590000R1006	MO496-50	2/37
1SAM201906R1124	PS1-4-2-65	2/28	1SAM350000R1014	MS132-25	2/7	1SAM590000R1007	MO496-63	2/37
1SAM201906R1125	PS1-5-2-65	2/28	1SAM350000R1015	MS132-32	2/7	1SAM590000R1008	MO496-75	2/37
1SAM201907R1101	S1-M1-25	2/28	1SAM350005R1001	MS132-0.16-HKF1-11	2/7	1SAM590000R1009	MO496-90	2/37
1SAM201907R1102	S1-M2-25	2/28	1SAM350005R1002	MS132-0.25-HKF1-11	2/7	1SAM590000R1010	MO496-100	2/37
1SAM201907R1103	S1-M3-25	2/28	1SAM350005R1003	MS132-0.4-HKF1-11	2/7	1SAX101110R0001	DB19E	7/28
1SAM201908R1001	BS1-3	2/28	1SAM350005R1004	MS132-0.63-HKF1-11	2/7	1SAX101910R1001	DB19EF	7/28
1SAM201909R1001	FS116	2/28	1SAM350005R1005	MS132-1.0-HKF1-11	2/7	1SAX111001R1101	E16DU-0.32	7/28
1SAM201909R1021	MSAH1	2/47	1SAM350005R1006	MS132-1.6-HKF1-11	2/7	1SAX111001R1102	E16DU-1.0	7/28
1SAM201910R1001	AA1-24	2/24	1SAM350005R1007	MS132-2.5-HKF1-11	2/7	1SAX111001R1103	E16DU-2.7	7/28
1SAM201910R1002	AA1-110	2/24	1SAM350005R1008	MS132-4.0-HKF1-11	2/7	1SAX111001R1104	E16DU-6.3	7/28
1SAM201910R1003	AA1-230	2/24	1SAM350005R1009	MS132-6.3-HKF1-11	2/7	1SAX111001R1105	E16DU-18.9	7/28
1SAM201910R1004	AA1-400	2/24	1SAM350005R1010	MS132-10.0-HKF1-11	2/7	1SAX121001R1101	EF19-0.32	7/28
1SAM201911R1010	IB132-G	2/31	1SAM350005R1011	MS132-16.0-HKF1-11	2/7	1SAX121001R1102	EF19-1.0	7/28
1SAM201911R1011	IB132-Y	2/31	1SAM350005R1012	MS132-12.0-HKF1-11	2/7	1SAX121001R1103	EF19-2.7	7/28
1SAM201912R1010	DMS132-G	2/31	1SAM350005R1013	MS132-20-HKF1-11	2/7	1SAX121001R1104	EF19-6.3	7/28
1SAM201912R1011	DMS132-Y	2/31	1SAM350005R1014	MS132-25-HKF1-11	2/7	1SAX121001R1105	EF19-18.9	5/38
1SAM201913R1103	S1-M3-35	2/28	1SAM350005R1015	MS132-32-HKF1-11	2/7	1SAX201910R0001	DB45EF	7/28
1SAM201914R1001	PB1-1-32	2/28	1SAM360000R1001	MO132-0.16	2/9	1SAX221001R1101	EF45-30	5/38
1SAM201914R1002	S1-PB1-25	2/28	1SAM360000R1002	MO132-0.25	2/9	1SAX221001R1102	EF45-45	5/38
1SAM201916R1103	PS1-3-0-100	2/28	1SAM360000R1003	MO132-0.4	2/9	1SAX331001R1101	EF65-70	5/38
1SAM201916R1104	PS1-4-0-100	2/28	1SAM360000R1004	MO132-0.63	2/9	1SAX331001R1102	EF65-56	7/32
1SAM201916R1105	PS1-5-0-100	2/28	1SAM360000R1005	MO132-1.0	2/9	1SAX341001R1101	EF96-100	5/38
1SAM201916R1113	PS1-3-1-100	2/28	1SAM360000R1006	MO132-1.6	2/9	1SAX351001R1101	EF146-150	5/22
1SAM201916R1114	PS1-4-1-100	2/28	1SAM360000R1007	MO132-2.5	2/9	1SAX501904R0001	LT200E	7/36
1SAM201916R1115	PS1-5-1-100	2/28	1SAM360000R1008	MO132-4.0	2/9	1SAX531001R1101	EF205-210	5/22
1SAM201916R1123	PS1-3-2-100	2/28	1SAM360000R1009	MO132-6.3	2/9	1SAX601904R0001	LT320E	7/36
1SAM201920R1000	MSH-AR	2/47	1SAM360000R1010	MO132-10	2/9	1SAX611001R1101	EF370-380	5/22
1SAM201920R1001	MSHD-LB	2/47	1SAM360000R1011	MO132-16	2/9	1SAX701904R0002	LT460EF	7/40
1SAM201920R1002	MSHD-LY	2/47	1SAM360000R1012	MO132-12	2/9	1SAX721001R1101	EF460-500	7/40
1SAM201920R1011	MSHD-LTB	2/47	1SAM360000R1013	MO132-20	2/9	1SAX801904R0002	LT750EF	7/40
1SAM201920R1012	MSHD-LTY	2/47	1SAM360000R1014	MO132-25	2/9	1SAX821001R1101	EF750-800	7/40
1SAM250000R1001	MS116-0.16	2/6	1SAM360000R1015	MO132-32	2/9	1SAZ401110R0001	DB200	7/24
1SAM250000R1002	MS116-0.25	2/6	1SAM401901R1001	HK4-11	2/44	1SAZ401901R1001	LT200/A	7/24
1SAM250000R1003	MS116-0.4	2/6	1SAM401901R1002	HK4-W	2/44	1SAZ421201R1001	TA200DU-90	7/24
1SAM250000R1004	MS116-0.63	2/6	1SAM401902R1001	HKS4-11	2/44	1SAZ421201R1002	TA200DU-110	7/24
1SAM250000R1005	MS116-1.0	2/6	1SAM401902R1002	HKS4-20	2/44	1SAZ421201R1003	TA200DU-135	7/24
1SAM250000R1006	MS116-1.6	2/6	1SAM401902R1003	HKS4-02	2/44	1SAZ421201R1004	TA200DU-150	7/24
1SAM250000R1007	MS116-2.5	2/6	1SAM401904R1001	SK4-11	2/44	1SAZ421201R1005	TA200DU-175	5/22
1SAM250000R1008	MS116-4.0	2/6	1SAM401905R1001	UA4-110	2/44	1SAZ421201R1006	TA200DU-200	5/22
1SAM250000R1009	MS116-6.3	2/6	1SAM401905R1002	UA4-230	2/44	1SAZ421301R1001	TA200DU-90-V1000	7/24
1SAM250000R1010	MS116-10	2/6	1SAM401905R1003	UA4-400	2/44	1SAZ421301R1002	TA200DU-110-V1000	7/24
1SAM250000R1011	MS116-16	2/6	1SAM401905R1004	UA4-24	2/44	1SAZ421301R1003	TA200DU-135-V1000	7/24
1SAM250000R1012	MS116-12	2/6	1SAM401906R1001	UA4-HK-230	2/44	1SAZ421301R1004	TA200DU-150-V1000	7/24
1SAM250000R1013	MS116-20	2/6	1SAM401906R1002	UA4-HK-400	2/44	1SAZ421301R1005	TA200DU-175-V1000	7/24
1SAM250000R1014	MS116-25	2/6	1SAM401907R1001	AA4-24	2/44	1SAZ421301R1006	TA200DU-200-V1000	7/24
1SAM250000R1015	MS116-32	2/6	1SAM401907R1002	AA4-110	2/44	1SAZ431201R1001	TF140DU-90	7/20
1SAM250005R1001	MS116-0.16-HKF1-11	2/6	1SAM401907R1003	AA4-230	2/44	1SAZ431201R1002	TF140DU-110	5/22
1SAM250005R1002	MS116-0.25-HKF1-11	2/6	1SAM401907R1004	AA4-400	2/44	1SAZ431201R1003	TF140DU-135	5/36
1SAM250005R1003	MS116-0.4-HKF1-11	2/6	1SAM401912R1001	DX495	2/44	1SAZ431201R1004	TF140DU-142	5/22
1SAM250005R1004	MS116-0.63-HKF1-11	2/6	1SAM401920R1002	PS2-2-0-125	2/29	1SAZ431301R1001	TF140DU-90-V1000	7/20
1SAM250005R1005	MS116-1.0-HKF1-11	2/6	1SAM401920R1003	PS2-3-0-125	2/29	1SAZ431301R1002	TF140DU-110-V1000	7/20
1SAM250005R1006	MS116-1.6-HKF1-11	2/6	1SAM401920R1004	PS2-4-0-125	2/29	1SAZ431301R1003	TF140DU-135-V1000	7/20
1SAM250005R1007	MS116-2.5-HKF1-11	2/6	1SAM401920R1022	PS2-2-2-125	2/29	1SAZ431301R1004	TF140DU-142-V1000	7/20
1SAM250005R1008	MS116-4.0-HKF1-11	2/6	1SAM401920R1023	PS2-3-2-125	2/29	1SAZ701901R0001	DB16	7/4
1SAM250005R1009	MS116-6.3-HKF1-11	2/6	1SAM401920R1024	PS2-4-2-125	2/29	1SAZ701902R0001	DB42	7/8
1SAM250005R1010	MS116-10.0-HKF1-11	2/6	1SAM401921R1001	BS2-3	2/29	1SAZ701903R1001	WRH-F	7/46
1SAM250005R1011	MS116-16.0-HKF1-11	2/6	1SAM401922R1001	KA165	2/29	1SAZ701903R1011	WRB-400	7/46
1SAM250005R1012	MS116-12.0-HKF1-11	2/6	1SAM451000R1011	MS165-16	2/8	1SAZ701903R1012	WRB-600	7/46

Index

Order code classification

Order code	Type	Page	Order code	Type	Page	Order code	Type	Page
1SAZ701903R1013	WRB-1000	7/46	1SBH103001R8122	NSL22E-81	4/63	1SBH137001R1239	NF33/11-12	5/322
1SAZ701903R1030	WRBG	7/46	1SBH103001R8131	NSL31E-81	4/63	1SBH137001R1240	NF40E-12	5/318
1SAZ711201R1005	T16-0.13	4/20	1SBH103001R8140	NSL40E-81	4/63	1SBH137001R1244	NF44E-12	5/322
1SAZ711201R1008	T16-0.17	4/20	1SBH103001R8144	NSL44E-81	4/63	1SBH137001R1253	NF53E-12	5/322
1SAZ711201R1009	T16-0.23	4/20	1SBH103001R8153	NSL53E-81	4/63	1SBH137001R1259	NF51/11-12	5/322
1SAZ711201R1013	T16-0.31	4/20	1SBH103001R8162	NSL62E-81	4/63	1SBH137001R1262	NF62E-12	5/322
1SAZ711201R1014	T16-0.41	4/20	1SBH103001R8171	NSL71E-81	4/63	1SBH137001R1271	NF71E-12	5/322
1SAZ711201R1017	T16-0.55	4/20	1SBH103001R8180	NSL80E-81	4/63	1SBH137001R1280	NF80E-12	5/322
1SAZ711201R1021	T16-0.74	4/20	1SBH103004R8122	NSL22ES-81	6/23	1SBH137001R1322	NF22E-13	5/318
1SAZ711201R1023	T16-1.0	4/20	1SBH103004R8131	NSL31ES-81	6/23	1SBH137001R1331	NF31E-13	5/318
1SAZ711201R1025	T16-1.3	4/20	1SBH103004R8140	NSL40ES-81	6/23	1SBH137001R1339	NF33/11-13	5/322
1SAZ711201R1028	T16-1.7	4/20	1SBH103004R8144	NSL44ES-81	6/23	1SBH137001R1340	NF40E-13	5/318
1SAZ711201R1031	T16-2.3	4/20	1SBH103004R8153	NSL53ES-81	6/23	1SBH137001R1344	NF44E-13	5/322
1SAZ711201R1033	T16-3.1	4/20	1SBH103004R8162	NSL62ES-81	6/23	1SBH137001R1353	NF53E-13	5/322
1SAZ711201R1035	T16-4.2	4/20	1SBH103004R8171	NSL71ES-81	6/23	1SBH137001R1359	NF51/11-13	5/322
1SAZ711201R1038	T16-5.7	4/20	1SBH103004R8180	NSL80ES-81	6/23	1SBH137001R1362	NF62E-13	5/322
1SAZ711201R1040	T16-7.6	4/20	1SBH136001R2022	NFZ22E-20	5/319	1SBH137001R1371	NF71E-13	5/322
1SAZ711201R1043	T16-10	4/20	1SBH136001R2031	NFZ31E-20	5/319	1SBH137001R1380	NF80E-13	5/322
1SAZ711201R1045	T16-13	4/20	1SBH136001R2039	NFZ33/11-20	5/323	1SBH137001R1422	NF22E-14	5/318
1SAZ711201R1047	T16-16	4/20	1SBH136001R2040	NFZ40E-20	5/319	1SBH137001R1431	NF31E-14	5/318
1SAZ721201R1005	TF42-0.13	7/8	1SBH136001R2044	NFZ44E-20	5/323	1SBH137001R1439	NF33/11-14	5/322
1SAZ721201R1008	TF42-0.17	7/8	1SBH136001R2053	NFZ53E-20	5/323	1SBH137001R1440	NF40E-14	5/318
1SAZ721201R1009	TF42-0.23	7/8	1SBH136001R2059	NFZ51/11-20	5/323	1SBH137001R1444	NF44E-14	5/322
1SAZ721201R1013	TF42-0.31	7/8	1SBH136001R2062	NFZ62E-20	5/323	1SBH137001R1453	NF53E-14	5/322
1SAZ721201R1014	TF42-0.41	7/8	1SBH136001R2071	NFZ71E-20	5/323	1SBH137001R1459	NF51/11-14	5/322
1SAZ721201R1017	TF42-0.55	7/8	1SBH136001R2080	NFZ80E-20	5/323	1SBH137001R1462	NF62E-14	5/322
1SAZ721201R1021	TF42-0.74	7/8	1SBH136001R2122	NFZ22E-21	5/319	1SBH137001R1471	NF71E-14	5/322
1SAZ721201R1023	TF42-1.0	7/8	1SBH136001R2131	NFZ31E-21	5/319	1SBH137001R1480	NF80E-14	5/322
1SAZ721201R1025	TF42-1.3	7/8	1SBH136001R2139	NFZ33/11-21	5/323	1SBH137001R1422	NF22E-14	5/318
1SAZ721201R1028	TF42-1.7	7/8	1SBH136001R2140	NFZ40E-21	5/319	1SBH137001R4131	NF31E-41	5/318
1SAZ721201R1031	TF42-2.3	7/8	1SBH136001R2144	NFZ44E-21	5/323	1SBH137001R4139	NF33/11-41	5/322
1SAZ721201R1033	TF42-3.1	7/8	1SBH136001R2153	NFZ53E-21	5/323	1SBH137001R4140	NF40E-41	5/318
1SAZ721201R1035	TF42-4.2	7/8	1SBH136001R2159	NFZ51/11-21	5/323	1SBH137001R4144	NF44E-41	5/322
1SAZ721201R1038	TF42-5.7	7/8	1SBH136001R2162	NFZ62E-21	5/323	1SBH137001R4153	NF53E-41	5/322
1SAZ721201R1040	TF42-7.6	7/8	1SBH136001R2171	NFZ71E-21	5/323	1SBH137001R4159	NF51/11-41	5/322
1SAZ721201R1043	TF42-10	5/36	1SBH136001R2180	NFZ80E-21	5/323	1SBH137001R4162	NF62E-41	5/322
1SAZ721201R1045	TF42-13	5/36	1SBH136001R2222	NFZ22E-22	5/319	1SBH137001R4171	NF71E-41	5/322
1SAZ721201R1047	TF42-16	5/36	1SBH136001R2231	NFZ31E-22	5/319	1SBH137001R4180	NF80E-41	5/322
1SAZ721201R1049	TF42-20	5/60	1SBH136001R2239	NFZ33/11-22	5/323	1SBH137004R1222	NF22ES-12	6/68
1SAZ721201R1051	TF42-24	5/36	1SBH136001R2240	NFZ40E-22	5/319	1SBH137004R1231	NF31ES-12	6/68
1SAZ721201R1052	TF42-29	5/60	1SBH136001R2244	NFZ44E-22	5/323	1SBH137004R1240	NF40ES-12	6/68
1SAZ721201R1053	TF42-35	5/36	1SBH136001R2253	NFZ53E-22	5/323	1SBH137004R1244	NF44ES-12	6/70
1SAZ721201R1055	TF42-38	5/36	1SBH136001R2259	NFZ51/11-22	5/323	1SBH137004R1253	NF53ES-12	6/70
1SAZ801901R1001	DB65	7/12	1SBH136001R2262	NFZ62E-22	5/323	1SBH137004R1262	NF62ES-12	6/70
1SAZ811201R1001	TF65-28	7/12	1SBH136001R2271	NFZ71E-22	5/323	1SBH137004R1271	NF71ES-12	6/70
1SAZ811201R1002	TF65-33	7/12	1SBH136001R2280	NFZ80E-22	5/323	1SBH137004R1280	NF80ES-12	6/70
1SAZ811201R1003	TF65-40	5/36	1SBH136001R2322	NFZ22E-23	5/319	1SBH137004R1322	NF22ES-13	6/68
1SAZ811201R1004	TF65-47	5/36	1SBH136001R2371	NFZ71E-23	5/323	1SBH137004R1331	NF31ES-13	6/68
1SAZ811201R1005	TF65-53	7/12	1SBH136001R2339	NFZ33/11-23	5/323	1SBH137004R1340	NF40ES-13	6/68
1SAZ811201R1006	TF65-60	5/36	1SBH136001R2340	NFZ40E-23	5/319	1SBH137004R1344	NF44ES-13	6/70
1SAZ811201R1007	TF65-67	7/12	1SBH136001R2344	NFZ44E-23	5/323	1SBH137004R1353	NF53ES-13	6/70
1SAZ901901R1001	DB96	7/16	1SBH136001R2353	NFZ53E-23	5/323	1SBH137004R1362	NF62ES-13	6/70
1SAZ911201R1001	TF96-51	7/16	1SBH136001R2359	NFZ51/11-23	5/323	1SBH137004R1371	NF71ES-13	6/70
1SAZ911201R1002	TF96-60	7/16	1SBH136001R2362	NFZ62E-23	5/323	1SBH137004R1380	NF80ES-13	6/70
1SAZ911201R1003	TF96-68	5/36	1SBH136001R2371	NFZ71E-23	5/323	1SBH137004R1422	NF22ES-14	6/68
1SAZ911201R1004	TF96-78	5/60	1SBH136001R2380	NFZ80E-23	5/323	1SBH137004R1431	NF31ES-14	6/68
1SAZ911201R1005	TF96-87	5/36	1SBH136004R2022	NFZ22ES-20	6/69	1SBH137004R1440	NF40ES-14	6/68
1SAZ911201R1006	TF96-96	5/60	1SBH136004R2031	NFZ31ES-20	6/69	1SBH137004R1444	NF44ES-14	6/70
1SBH101001R2022	NS22E-20	4/62	1SBH136004R2040	NFZ40ES-20	6/69	1SBH137004R1453	NF53ES-14	6/70
1SBH101001R2031	NS31E-20	4/62	1SBH136004R2044	NFZ44ES-20	6/71	1SBH137004R1462	NF62ES-14	6/70
1SBH101001R2040	NS40E-20	4/62	1SBH136004R2053	NFZ53ES-20	6/71	1SBH137004R1471	NF71ES-14	6/70
1SBH101001R2044	NS44E-20	4/62	1SBH136004R2062	NFZ62ES-20	6/71	1SBH137004R1480	NF80ES-14	6/70
1SBH101001R2053	NS53E-20	4/62	1SBH136004R2071	NFZ71ES-20	6/71	1SBH137004R4122	NF22ES-14	6/68
1SBH101001R2062	NS62E-20	4/62	1SBH136004R2080	NFZ80ES-20	6/71	1SBH137004R4131	NF31ES-41	6/68
1SBH101001R2071	NS71E-20	4/62	1SBH136004R2122	NFZ22ES-21	6/69	1SBH137004R4140	NF40ES-41	6/68
1SBH101001R2080	NS80E-20	4/62	1SBH136004R2131	NFZ31ES-21	6/69	1SBH137004R4144	NF44ES-41	6/70
1SBH101001R2622	NS22E-26	4/62	1SBH136004R2140	NFZ40ES-21	6/69	1SBH137004R4153	NF53ES-41	6/70
1SBH101001R2631	NS31E-26	4/62	1SBH136004R2144	NFZ44ES-21	6/71	1SBH137004R4162	NF62ES-41	6/70
1SBH101001R2640	NS40E-26	4/62	1SBH136004R2153	NFZ53ES-21	6/71	1SBH137004R4171	NF71ES-41	6/70
1SBH101001R2644	NS44E-26	4/62	1SBH136004R2162	NFZ62ES-21	6/71	1SBH137004R4180	NF80ES-41	6/70
1SBH101001R2653	NS53E-26	4/62	1SBH136004R2171	NFZ71ES-21	6/71	1SBK103600M2000	VAS09EM-20M	4/46
1SBH101001R2662	NS62E-26	4/62	1SBH136004R2180	NFZ80ES-21	6/71	1SBK103600M2600	VAS09EM-26M	4/46
1SBH101001R2671	NS71E-26	4/62	1SBH136004R2222	NFZ22ES-22	6/69	1SBK103700M8100	VASL09EM-81M	4/47
1SBH101001R2680	NS80E-26	4/62	1SBH136004R2231	NFZ31ES-22	6/69	1SBK103800M2000	VAS09SEM-20M	4/46
1SBH101004R2022	NS22ES-20	6/22	1SBH136004R2240	NFZ40ES-22	6/69	1SBK103800M2600	VAS09SEM-26M	4/46
1SBH101004R2031	NS31ES-20	6/22	1SBH136004R2244	NFZ44ES-22	6/71	1SBK103900M8100	VASL09SEM-81M	4/47
1SBH101004R2040	NS40ES-20	6/22	1SBH136004R2253	NFZ53ES-22	6/71	1SBK104035R2800	DRAS09-28P	8/2
1SBH101004R2044	NS44ES-20	6/22	1SBH136004R2262	NFZ62ES-22	6/71	1SBK104035R2900	DRAS09-29P	8/2
1SBH101004R2053	NS53ES-20	6/22	1SBH136004R2271	NFZ71ES-22	6/71	1SBK104135R2600	DRAS09-26N	8/2
1SBH101004R2062	NS62ES-20	6/22	1SBH136004R2280	NFZ80ES-22	6/71	1SBK104135R2700	DRAS09-27N	8/2
1SBH101004R2071	NS71ES-20	6/22	1SBH136004R2322	NFZ22ES-23	6/69	1SBK104235R2000	DRAS09-20S	8/2
1SBH101004R2080	NS80ES-20	6/22	1SBH136004R2331	NFZ31ES-23	6/69	1SBK104335R8100	DRASL09-81S	8/2
1SBH101004R2622	NS22ES-26	6/22	1SBH136004R2340	NFZ40ES-23	6/69	1SBK104335R8300	DRASL09-83S	8/2
1SBH101004R2631	NS31ES-26	6/22	1SBH136004R2344	NFZ44ES-23	6/71	1SBK13600M2000	VAS12EM-20M	4/46
1SBH101004R2640	NS40ES-26	6/22	1SBH136004R2353	NFZ53ES-23	6/71	1SBK13600M2600	VAS12EM-26M	4/46
1SBH101004R2644	NS44ES-26	6/22	1SBH136004R2362	NFZ62ES-23	6/71	1SBK13700M8100	VASL12EM-81M	4/47
1SBH101004R2653	NS53ES-26	6/22	1SBH136004R2371	NFZ71ES-23	6/71	1SBK13800M2000	VAS12SEM-20M	4/46
1SBH101004R2662	NS62ES-26	6/22	1SBH136004R2380	NFZ80ES-23	6/71	1SBK13800M2600	VAS12SEM-26M	4/46
1SBH101004R2671	NS71ES-26	6/22	1SBH137001R1222	NF22E-12	5/318	1SBK13900M8100	VASL12SEM-81M	4/47
1SBH101004R2680	NS80ES-26	6/22	1SBH137001R1231	NF31E-12	5/318	1SBK114035R2800	DRAS12-28P	8/2

Index

Order code classification

Order code	Type	Page
1SBK114035R2900	DRAS12-29P	8/2
1SBK114135R2600	DRAS12-26N	8/2
1SBK114135R2700	DRAS12-27N	8/2
1SBK114235R2000	DRAS12-20S	8/2
1SBK114335R8100	DRASL12-81S	8/2
1SBK114335R8300	DRASL12-83S	8/2
1SBK123600M2000	VAS16EM-20M	4/46
1SBK123600M2600	VAS16EM-26M	4/46
1SBK123700M8100	VASL16EM-81M	4/47
1SBK123800M2000	VAS16SEM-20M	4/46
1SBK123800M2600	VAS16SEM-26M	4/46
1SBK123900M8100	VASL16SEM-81M	4/47
1SBK124035R2800	DRAS16-28P	8/2
1SBK124035R2900	DRAS16-29P	8/2
1SBK124135R2600	DRAS16-26N	8/2
1SBK124135R2700	DRAS16-27N	8/2
1SBK124235R2000	DRAS16-20S	8/2
1SBK124335R8100	DRASL16-81S	8/2
1SBK124335R8300	DRASL16-83S	8/2
1SBK134037R1400	DRAF09-14P	8/8
1SBK134137R1300	DRAF09-13N	8/8
1SBK134237R1100	DRAF09-11S	8/8
1SBK134238R1100	DRAF09-11U	8/8
1SBK134238R1300	DRAF09-13U	8/8
1SBK134238R1400	DRAF09-14U	8/8
1SBK154037R1400	DRAF12-14P	8/8
1SBK154137R1300	DRAF12-13N	8/8
1SBK154237R1100	DRAF12-11S	8/8
1SBK154238R1100	DRAF12-11U	8/8
1SBK154238R1300	DRAF12-13U	8/8
1SBK154238R1400	DRAF12-14U	8/8
1SBK174037R1400	DRAF16-14P	8/8
1SBK174137R1300	DRAF16-13N	8/8
1SBK174237R1100	DRAF16-11S	8/8
1SBK174238R1100	DRAF16-11U	8/8
1SBK174238R1300	DRAF16-13U	8/8
1SBK174238R1400	DRAF16-14U	8/8
1SBL101001R2001	AS09-30-01-20	4/14
1SBL101001R2010	AS09-30-10-20	4/10
1SBL101001R2032	AS09-30-32-20	4/34
1SBL101001R2601	AS09-30-01-26	4/14
1SBL101001R2610	AS09-30-10-26	4/10
1SBL101001R2632	AS09-30-32-26	4/34
1SBL101004R2001	AS09-30-01-20	6/4
1SBL101004R2010	AS09-30-10S-20	6/4
1SBL101004R2032	AS09-30-32S-20	6/6
1SBL101004R2601	AS09-30-01S-26	6/4
1SBL101004R2610	AS09-30-10S-26	6/4
1SBL101004R2632	AS09-30-32S-26	6/6
1SBL103001R8101	ASL09-30-01-81	4/15
1SBL103001R8110	ASL09-30-10-81	4/11
1SBL103001R8132	ASL09-30-32-81	4/35
1SBL103004R8101	ASL09-30-01S-81	6/5
1SBL103004R8110	ASL09-30-10S-81	6/5
1SBL103004R8132	ASL09-30-32S-81	6/7
1SBL111001R2001	AS12-30-01-20	4/14
1SBL111001R2010	AS12-30-10-20	4/10
1SBL111001R2032	AS12-30-32-20	4/34
1SBL111001R2601	AS12-30-01-26	4/14
1SBL111001R2610	AS12-30-10-26	4/10
1SBL111001R2632	AS12-30-32-26	4/34
1SBL111004R2001	AS12-30-01S-20	6/4
1SBL111004R2010	AS12-30-10S-20	6/4
1SBL111004R2032	AS12-30-32S-20	6/6
1SBL111004R2601	AS12-30-01S-26	6/4
1SBL111004R2610	AS12-30-10S-26	6/4
1SBL111004R2632	AS12-30-32S-26	6/6
1SBL113001R8101	ASL12-30-01-81	4/15
1SBL113001R8110	ASL12-30-10-81	4/11
1SBL113001R8132	ASL12-30-32-81	4/35
1SBL113004R8101	ASL12-30-01S-81	6/5
1SBL113004R8110	ASL12-30-10S-81	6/5
1SBL113004R8132	ASL12-30-32S-81	6/7
1SBL121001R2001	AS16-30-01-20	4/14
1SBL121001R2010	AS16-30-10-20	4/10
1SBL121001R2032	AS16-30-32-20	4/34
1SBL121001R2601	AS16-30-01-26	4/14
1SBL121001R2610	AS16-30-10-26	4/10
1SBL121001R2632	AS16-30-32-26	4/34
1SBL121004R2001	AS16-30-01S-20	6/4
1SBL121004R2010	AS16-30-10S-20	6/4
1SBL121004R2032	AS16-30-32S-20	6/6
1SBL121004R2601	AS16-30-01S-26	6/4
1SBL121004R2610	AS16-30-10S-26	6/4
1SBL121004R2632	AS16-30-32S-26	6/6
1SBL123001R8101	ASL16-30-01-81	4/15
1SBL123001R8110	ASL16-30-10-81	4/11
1SBL123001R8132	ASL16-30-32-81	4/35
1SBL123004R8101	ASL16-30-01S-81	6/5
1SBL123004R8110	ASL16-30-10S-81	6/5
1SBL123004R8132	ASL16-30-32S-81	6/7

Order code	Type	Page
1SBL136001R2001	AF09Z-30-01-20	5/85
1SBL136001R2010	AF09Z-30-10-20	5/85
1SBL136001R2022	AF09Z-30-22-20	5/109
1SBL136001R2101	AF09Z-30-01-21	5/85
1SBL136001R2110	AF09Z-30-10-21	5/6
1SBL136001R2122	AF09Z-30-22-21	5/109
1SBL136001R2201	AF09Z-30-01-22	5/85
1SBL136001R2210	AF09Z-30-10-22	5/85
1SBL136001R2222	AF09Z-30-22-22	5/109
1SBL136001R2301	AF09Z-30-01-23	5/85
1SBL136001R2310	AF09Z-30-10-23	5/85
1SBL136001R2322	AF09Z-30-22-23	5/109
1SBL136004R2001	AF09Z-30-01S-20	6/47
1SBL136004R2010	AF09Z-30-10S-20	6/47
1SBL136004R2022	AF09Z-30-22S-20	6/49
1SBL136004R2101	AF09Z-30-01S-21	6/47
1SBL136004R2110	AF09Z-30-10S-21	6/47
1SBL136004R2122	AF09Z-30-22S-21	6/49
1SBL136004R2201	AF09Z-30-01S-22	6/47
1SBL136004R2210	AF09Z-30-10S-22	6/47
1SBL136004R2222	AF09Z-30-22S-22	6/49
1SBL136004R2301	AF09Z-30-01S-23	6/47
1SBL136004R2310	AF09Z-30-10S-23	6/47
1SBL136004R2322	AF09Z-30-22S-23	6/49
1SBL136201R2000	AF09Z-40-00-20	5/191
1SBL136201R2100	AF09Z-40-00-21	5/191
1SBL136201R2200	AF09Z-40-00-22	5/191
1SBL136201R2300	AF09Z-40-00-23	5/191
1SBL136501R2000	AF09Z-22-00-20	5/191
1SBL136501R2100	AF09Z-22-00-21	5/191
1SBL136501R2200	AF09Z-22-00-22	5/191
1SBL136501R2300	AF09Z-22-00-23	5/191
1SBL137001R1201	AF09-30-01-12	5/84
1SBL137001R1210	AF09-30-10-12	5/84
1SBL137001R1222	AF09-30-22-12	5/108
1SBL137001R1301	AF09-30-01-13	5/84
1SBL137001R1310	AF09-30-10-13	5/6
1SBL137001R1322	AF09-30-22-13	5/108
1SBL137001R1401	AF09-30-01-14	5/84
1SBL137001R1410	AF09-30-10-14	5/84
1SBL137001R1422	AF09-30-22-14	5/108
1SBL137001R4101	AF09-30-01-41	5/84
1SBL137001R4110	AF09-30-10-41	5/84
1SBL137001R4122	AF09-30-22-41	5/108
1SBL137004R1201	AF09-30-01S-12	6/46
1SBL137004R1210	AF09-30-10S-12	6/46
1SBL137004R1222	AF09-30-22S-12	6/48
1SBL137004R1301	AF09-30-01S-13	6/46
1SBL137004R1310	AF09-30-10S-13	6/46
1SBL137004R1322	AF09-30-22S-13	6/48
1SBL137004R1401	AF09-30-01S-14	6/46
1SBL137004R1410	AF09-30-10S-14	6/46
1SBL137004R1422	AF09-30-22S-14	6/48
1SBL137004R4101	AF09-30-01S-41	6/46
1SBL137004R4110	AF09-30-10S-41	6/46
1SBL137004R4122	AF09-30-22S-41	6/48
1SBL137201R1200	AF09-40-00-12	5/190
1SBL137201R1300	AF09-40-00-13	5/190
1SBL137201R1400	AF09-40-00-14	5/190
1SBL137201R4100	AF09-40-00-41	5/190
1SBL137501R1200	AF09-22-00-12	5/190
1SBL137501R1300	AF09-22-00-13	5/190
1SBL137501R1400	AF09-22-00-14	5/190
1SBL137501R4100	AF09-22-00-41	5/190
1SBL156001R2001	AF12Z-30-01-20	5/85
1SBL156001R2010	AF12Z-30-10-20	5/85
1SBL156001R2022	AF12Z-30-22-20	5/109
1SBL156001R2101	AF12Z-30-01-21	5/85
1SBL156001R2110	AF12Z-30-10-21	5/6
1SBL156001R2122	AF12Z-30-22-21	5/109
1SBL156001R2201	AF12Z-30-01-22	5/85
1SBL156001R2210	AF12Z-30-10-22	5/85
1SBL156001R2222	AF12Z-30-22-22	5/109
1SBL156001R2301	AF12Z-30-01-23	5/85
1SBL156001R2310	AF12Z-30-10-23	5/85
1SBL156001R2322	AF12Z-30-22-23	5/109
1SBL156004R2001	AF12Z-30-01S-20	6/47
1SBL156004R2010	AF12Z-30-10S-20	6/47
1SBL156004R2022	AF12Z-30-22S-20	6/49
1SBL156004R2101	AF12Z-30-01S-21	6/47
1SBL156004R2110	AF12Z-30-10S-21	6/47
1SBL156004R2122	AF12Z-30-22S-21	6/49
1SBL156004R2201	AF12Z-30-01S-22	6/47
1SBL156004R2210	AF12Z-30-10S-22	6/47
1SBL156004R2222	AF12Z-30-22S-22	6/49
1SBL156004R2301	AF12Z-30-01S-23	6/47
1SBL156004R2310	AF12Z-30-10S-23	6/47
1SBL156004R2322	AF12Z-30-22S-23	6/49
1SBL157001R1201	AF12-30-01-12	5/84
1SBL157001R1210	AF12-30-10-12	5/84
1SBL157001R1222	AF12-30-22-12	5/108
1SBL157001R1301	AF12-30-01-13	5/84
1SBL157001R1310	AF12-30-10-13	5/84
1SBL157001R1322	AF12-30-22-13	5/108
1SBL157001R1401	AF12-30-01-14	5/84
1SBL157001R1410	AF12-30-10-14	5/84
1SBL157001R1422	AF12-30-22-14	5/108
1SBL157001R4101	AF12-30-01-41	5/84
1SBL157001R4110	AF12-30-10-41	5/84
1SBL157001R4122	AF12-30-22-41	5/108
1SBL157004R1201	AF16Z-30-01S-12	6/46
1SBL157004R1210	AF16Z-30-10S-12	6/46
1SBL157004R1222	AF16Z-30-22S-12	6/48
1SBL157004R1301	AF16Z-30-01S-13	6/46
1SBL157004R1310	AF16Z-30-10S-13	6/46
1SBL157004R1322	AF16Z-30-22S-13	6/48
1SBL157004R1401	AF16Z-30-01S-14	6/46
1SBL157004R1410	AF16Z-30-10S-14	6/46
1SBL157004R1422	AF16Z-30-22S-14	6/48
1SBL157004R4101	AF16Z-30-01S-41	6/46
1SBL157004R4110	AF16Z-30-10S-41	6/46
1SBL157004R4122	AF16Z-30-22S-41	6/48
1SBL157004R4201	AF16Z-30-01-20	5/85
1SBL157004R2010	AF16Z-30-10-20	5/85
1SBL157004R2022	AF16Z-30-22-20	5/109
1SBL157004R2101	AF16Z-30-01-21	5/85
1SBL157004R2110	AF16Z-30-10-21	5/6
1SBL157004R2122	AF16Z-30-22-21	5/109
1SBL157004R2201	AF16Z-30-01-22	5/85
1SBL157004R2210	AF16Z-30-10-22	5/85
1SBL157004R2222	AF16Z-30-22-22	5/109
1SBL157004R2301	AF16Z-30-01-23	5/85
1SBL157004R2310	AF16Z-30-10-23	5/85
1SBL157004R2322	AF16Z-30-22-23	5/109
1SBL157004R2001	AF16Z-30-01S-20	6/47
1SBL157004R2010	AF16Z-30-10S-20	6/47
1SBL157004R2022	AF16Z-30-22S-20	6/49
1SBL157004R2101	AF16Z-30-01S-21	6/47
1SBL157004R2110	AF16Z-30-10S-21	6/47
1SBL157004R2122	AF16Z-30-22S-21	6/49
1SBL157004R2201	AF16Z-30-01S-22	6/47
1SBL157004R2210	AF16Z-30-10S-22	6/47
1SBL157004R2222	AF16Z-30-22S-22	6/49
1SBL157004R2301	AF16Z-30-01S-23	6/47
1SBL157004R2310	AF16Z-30-10S-23	6/47
1SBL157004R2322	AF16Z-30-22S-23	6/49
1SBL176001R2001	AF16Z-30-01-20	5/85
1SBL176001R2010	AF16Z-30-10-20	5/85
1SBL176001R2022	AF16Z-30-22-20	5/109
1SBL176001R2101	AF16Z-30-01-21	5/85
1SBL176001R2110	AF16Z-30-10-21	5/6
1SBL176001R2122	AF16Z-30-22-21	5/109
1SBL176001R2201	AF16Z-30-01-22	5/85
1SBL176001R2210	AF16Z-30-10-22	5/85
1SBL176001R2222	AF16Z-30-22-22	5/109
1SBL176001R2301	AF16Z-30-01-23	5/85
1SBL176001R2310	AF16Z-30-10-23	5/85
1SBL176001R2322	AF16Z-30-22-23	5/109
1SBL176004R2001	AF16Z-30-01S-20	6/47
1SBL176004R2010	AF16Z-30-10S-20	6/47
1SBL176004R2022	AF16Z-30-22S-20	6/49
1SBL176004R21		

Index

Order code classification

Order code	Type	Page
1SBL181022R8810	UA16-30-10	5/285
1SBL181024R8010	UA16-30-10RA	5/276
1SBL181024R8110	UA16-30-10RA	5/276
1SBL181024R8310	UA16-30-10RA	5/276
1SBL181024R8410	UA16-30-10RA	5/276
1SBL181024R8510	UA16-30-10RA	5/276
1SBL181024R8610	UA16-30-10RA	5/276
1SBL181024R8810	UA16-30-10RA	5/276
1SBL236001R2000	AF26Z-30-00-20	5/85
1SBL236001R2011	AF26Z-30-11-20	5/109
1SBL236001R2022	AF26Z-30-22-20	5/109
1SBL236001R2100	AF26Z-30-00-21	5/6
1SBL236001R2111	AF26Z-30-11-21	5/109
1SBL236001R2122	AF26Z-30-22-21	5/109
1SBL236001R2200	AF26Z-30-00-22	5/85
1SBL236001R2211	AF26Z-30-11-22	5/109
1SBL236001R2222	AF26Z-30-22-22	5/109
1SBL236001R2300	AF26Z-30-00-23	5/85
1SBL236001R2311	AF26Z-30-11-23	5/109
1SBL236001R2322	AF26Z-30-22-23	5/109
1SBL236004R2000	AF26Z-30-00S-20	6/47
1SBL236004R2011	AF26Z-30-11S-20	6/49
1SBL236004R2022	AF26Z-30-22S-20	6/49
1SBL236004R2100	AF26Z-30-00S-21	6/47
1SBL236004R2111	AF26Z-30-11S-21	6/49
1SBL236004R2122	AF26Z-30-22S-21	6/49
1SBL236004R2200	AF26Z-30-00S-22	6/47
1SBL236004R2211	AF26Z-30-11S-22	6/49
1SBL236004R2222	AF26Z-30-22S-22	6/49
1SBL236004R2300	AF26Z-30-00S-23	6/47
1SBL236004R2311	AF26Z-30-11S-23	6/49
1SBL236004R2322	AF26Z-30-22S-23	6/49
1SBL236201R2000	AF26Z-40-00-20	5/191
1SBL236201R2100	AF26Z-40-00-21	5/191
1SBL236201R2200	AF26Z-40-00-22	5/191
1SBL236201R2300	AF26Z-40-00-23	5/191
1SBL236501R2000	AF26Z-22-00-20	5/191
1SBL236501R2100	AF26Z-22-00-21	5/191
1SBL236501R2200	AF26Z-22-00-22	5/191
1SBL236501R2300	AF26Z-22-00-23	5/191
1SBL237001R1200	AF26-30-00-12	5/84
1SBL237001R1211	AF26-30-11-12	5/108
1SBL237001R1222	AF26-30-22-12	5/108
1SBL237001R1300	AF26-30-00-13	5/6
1SBL237001R1311	AF26-30-11-13	5/108
1SBL237001R1322	AF26-30-22-13	5/108
1SBL237001R1400	AF26-30-00-14	5/84
1SBL237001R1411	AF26-30-11-14	5/108
1SBL237001R1422	AF26-30-22-14	5/108
1SBL237001R4100	AF26-30-00-41	5/84
1SBL237001R4111	AF26-30-11-41	5/108
1SBL237001R4122	AF26-30-22-41	5/108
1SBL237004R1200	AF26-30-00S-12	6/46
1SBL237004R1211	AF26-30-11S-12	6/48
1SBL237004R1222	AF26-30-22S-12	6/48
1SBL237004R1300	AF26-30-00S-13	6/46
1SBL237004R1311	AF26-30-11S-13	6/48
1SBL237004R1322	AF26-30-22S-13	6/48
1SBL237004R1400	AF26-30-00S-14	6/46
1SBL237004R1411	AF26-30-11S-14	6/48
1SBL237004R1422	AF26-30-22S-14	6/48
1SBL237004R4100	AF26-30-00S-41	6/46
1SBL237004R4111	AF26-30-11S-41	6/48
1SBL237004R4122	AF26-30-22S-41	6/48
1SBL237201R1200	AF26-40-00-12	5/190
1SBL237201R1300	AF26-40-00-13	5/190
1SBL237201R1400	AF26-40-00-14	5/190
1SBL237201R4100	AF26-40-00-41	5/190
1SBL237501R1200	AF26-22-00-12	5/190
1SBL237501R1300	AF26-22-00-13	5/190
1SBL237501R1400	AF26-22-00-14	5/190
1SBL237501R4100	AF26-22-00-41	5/190
1SBL241022R8010	UA26-30-10	5/285
1SBL241022R8110	UA26-30-10	5/285
1SBL241022R8310	UA26-30-10	5/285
1SBL241022R8410	UA26-30-10	5/285
1SBL241022R8510	UA26-30-10	5/285
1SBL241022R8610	UA26-30-10	5/285
1SBL241022R8810	UA26-30-10	5/285
1SBL241024R8010	UA26-30-10RA	5/276
1SBL241024R8110	UA26-30-10RA	5/276
1SBL241024R8310	UA26-30-10RA	5/276
1SBL241024R8410	UA26-30-10RA	5/276
1SBL241024R8510	UA26-30-10RA	5/276
1SBL241024R8610	UA26-30-10RA	5/276
1SBL241024R8810	UA26-30-10RA	5/276
1SBL276001R2000	AF30Z-30-00-20	5/85
1SBL276001R2011	AF30Z-30-11-20	5/109
1SBL276001R2022	AF30Z-30-22-20	5/109
1SBL276001R2100	AF30Z-30-00-21	5/6

Order code	Type	Page
1SBL276001R2111	AF30Z-30-11-21	5/109
1SBL276001R2122	AF30Z-30-22-21	5/109
1SBL276001R2200	AF30Z-30-00-22	5/85
1SBL276001R2211	AF30Z-30-11-22	5/109
1SBL276001R2222	AF30Z-30-22-22	5/109
1SBL276001R2300	AF30Z-30-00-23	5/85
1SBL276001R2311	AF30Z-30-11-23	5/109
1SBL276001R2322	AF30Z-30-22-23	5/109
1SBL277001R1200	AF30-30-00-12	5/84
1SBL277001R1211	AF30-30-11-12	5/108
1SBL277001R1222	AF30-30-22-12	5/108
1SBL277001R1300	AF30-30-00-13	5/6
1SBL277001R1311	AF30-30-11-13	5/108
1SBL277001R1322	AF30-30-22-13	5/108
1SBL277001R1400	AF30-30-00-14	5/84
1SBL277001R1411	AF30-30-11-14	5/108
1SBL277001R1422	AF30-30-22-14	5/108
1SBL277001R4100	AF30-30-00-41	5/84
1SBL277001R4111	AF30-30-11-41	5/108
1SBL277001R4122	AF30-30-22-41	5/108
1SBL281022R8010	UA30-30-10	5/285
1SBL281022R8110	UA30-30-10	5/285
1SBL281022R8310	UA30-30-10	5/285
1SBL281022R8410	UA30-30-10	5/285
1SBL281022R8510	UA30-30-10	5/285
1SBL281022R8610	UA30-30-10	5/285
1SBL281022R8810	UA30-30-10	5/285
1SBL281024R8010	UA30-30-10RA	5/276
1SBL281024R8110	UA30-30-10RA	5/276
1SBL281024R8310	UA30-30-10RA	5/276
1SBL281024R8410	UA30-30-10RA	5/276
1SBL281024R8510	UA30-30-10RA	5/276
1SBL281024R8610	UA30-30-10RA	5/276
1SBL281024R8810	UA30-30-10RA	5/276
1SBL296001R2000	AF38Z-30-00-20	5/85
1SBL296001R2011	AF38Z-30-11-20	5/109
1SBL296001R2022	AF38Z-30-22-20	5/109
1SBL296001R2100	AF38Z-30-00-21	5/36
1SBL296001R2111	AF38Z-30-11-21	5/109
1SBL296001R2122	AF38Z-30-22-21	5/109
1SBL296001R2200	AF38Z-30-00-22	5/85
1SBL296001R2211	AF38Z-30-11-22	5/109
1SBL296001R2222	AF38Z-30-22-22	5/109
1SBL296001R2300	AF38Z-30-00-23	5/85
1SBL296001R2311	AF38Z-30-11-23	5/109
1SBL296001R2322	AF38Z-30-22-23	5/109
1SBL296201R2000	AF38Z-40-00-20	5/191
1SBL296201R2100	AF38Z-40-00-21	5/191
1SBL296201R2200	AF38Z-40-00-22	5/191
1SBL296201R2300	AF38Z-40-00-23	5/191
1SBL296501R2000	AF38Z-22-00-20	5/191
1SBL296501R2100	AF38Z-22-00-21	5/191
1SBL296501R2200	AF38Z-22-00-22	5/191
1SBL296501R2300	AF38Z-22-00-23	5/191
1SBL297001R1200	AF38-30-00-12	5/84
1SBL297001R1211	AF38-30-11-12	5/108
1SBL297001R1222	AF38-30-22-12	5/108
1SBL297001R1300	AF38-30-00-13	5/36
1SBL297001R1311	AF38-30-11-13	5/108
1SBL297001R1322	AF38-30-22-13	5/108
1SBL297001R1400	AF38-30-00-14	5/84
1SBL297001R1411	AF38-30-11-14	5/108
1SBL297001R1422	AF38-30-22-14	5/108
1SBL297001R4100	AF38-30-00-41	5/84
1SBL297001R4111	AF38-30-11-41	5/108
1SBL297001R4122	AF38-30-22-41	5/108
1SBL297201R1200	AF38-40-00-12	5/190
1SBL297201R1300	AF38-40-00-13	5/190
1SBL297201R1400	AF38-40-00-14	5/190
1SBL297201R4100	AF38-40-00-41	5/190
1SBL297501R1200	AF38-22-00-12	5/190
1SBL297501R1300	AF38-22-00-13	5/190
1SBL297501R1400	AF38-22-00-14	5/190
1SBL297501R4100	AF38-22-00-41	5/190
1SBL347001R1100	AF40-30-00-11	5/6
1SBL347001R1111	AF40-30-11-11	5/110
1SBL347001R1122	AF40-30-22-11	5/110
1SBL347001R1200	AF40-30-00-12	5/86
1SBL347001R1211	AF40-30-11-12	5/110
1SBL347001R1222	AF40-30-22-12	5/110
1SBL347001R1300	AF40-30-00-13	5/6
1SBL347001R1311	AF40-30-11-13	5/110
1SBL347001R1322	AF40-30-22-13	5/110
1SBL347001R1400	AF40-30-00-14	5/86
1SBL347001R1411	AF40-30-11-14	5/110
1SBL347001R1422	AF40-30-22-14	5/110
1SBL347001R4100	AF40-30-00-41	5/86
1SBL347001R4111	AF40-30-11-41	5/110
1SBL347001R4122	AF40-30-22-41	5/110
1SBL347001R4100	AF40-30-00-41	5/86
1SBL347001R4111	AF40-30-11-41	5/110
1SBL347001R4122	AF40-30-22-41	5/110
1SBL374001R1100	AF40-40-00-11	5/192

Order code	Type	Page
1SBL347201R1200	AF40-40-00-12	5/192
1SBL347201R1300	AF40-40-00-13	5/192
1SBL347201R1400	AF40-40-00-14	5/192
1SBL347201R4100	AF40-40-00-41	5/192
1SBL347501R1100	AF40-22-00-11	5/192
1SBL347501R1200	AF40-22-00-12	5/192
1SBL347501R1300	AF40-22-00-13	5/192
1SBL347501R1400	AF40-22-00-14	5/192
1SBL347501R4100	AF40-22-00-41	5/192
1SBL351022R8000	UA50-30-00	5/286
1SBL351022R8011	UA50-30-11	5/287
1SBL351022R8100	UA50-30-00	5/286
1SBL351022R8111	UA50-30-11	5/287
1SBL351022R8300	UA50-30-00	5/286
1SBL351022R8311	UA50-30-11	5/287
1SBL351022R8400	UA50-30-00	5/286
1SBL351022R8411	UA50-30-11	5/287
1SBL351022R8500	UA50-30-00	5/286
1SBL351022R8511	UA50-30-11	5/287
1SBL351022R8600	UA50-30-00	5/286
1SBL351022R8611	UA50-30-11	5/287
1SBL351022R8800	UA50-30-00	5/286
1SBL351022R8811	UA50-30-11	5/287
1SBL351024R8000	UA50-30-00RA	5/277
1SBL351024R8100	UA50-30-00RA	5/277
1SBL351024R8300	UA50-30-00RA	5/277
1SBL351024R8400	UA50-30-00RA	5/277
1SBL351024R8500	UA50-30-00RA	5/277
1SBL351024R8600	UA50-30-00RA	5/277
1SBL351024R8800	UA50-30-00RA	5/277
1SBL367001R1100	AF52-30-00-11	5/6
1SBL367001R1111	AF52-30-11-11	5/110
1SBL367001R1122	AF52-30-22-11	5/110
1SBL367001R1200	AF52-30-00-12	5/86
1SBL367001R1211	AF52-30-11-12	5/110
1SBL367001R1222	AF52-30-22-12	5/110
1SBL367001R1300	AF52-30-00-13	5/6
1SBL367001R1311	AF52-30-11-13	5/110
1SBL367001R1322	AF52-30-22-13	5/110
1SBL367001R1400	AF52-30-00-14	5/86
1SBL367001R1411	AF52-30-11-14	5/110
1SBL367001R1422	AF52-30-22-14	5/110
1SBL367001R4100	AF52-30-00-41	5/86
1SBL367001R4111	AF52-30-11-41	5/110
1SBL367001R4122	AF52-30-22-41	5/110
1SBL367201R1100	AF52-40-00-11	5/192
1SBL367201R1200	AF52-40-00-12	5/192
1SBL367201R1300	AF52-40-00-13	5/192
1SBL367201R1400	AF52-40-00-14	5/192
1SBL367201R4100	AF52-40-00-41	5/192
1SBL371022R8000	UA63-30-00	5/286
1SBL371022R8011	UA63-30-11	5/287
1SBL371022R8100	UA63-30-00	5/286
1SBL371022R8111	UA63-30-11	5/287
1SBL371022R8300	UA63-30-00	5/286
1SBL371022R8311	UA63-30-11	5/287
1SBL371022R8400		

Index

Order code classification

Order code	Type	Page	Order code	Type	Page	Order code	Type	Page
1SBL397001R1211	AF80-30-11-12	5/111	1SBN010013R1001	CB5-01	5/354	1SBN031005T1000	VM3	4/14
1SBL397001R1222	AF80-30-22-12	5/111	1SBN010013R1010	CB5-10	5/354	1SBN081012R1000	BER16C-3	4/21
1SBL397001R1300	AF80-30-00-13	5/6	1SBN010015R1001	CE5-01D0.1	5/338	1SBN081018R2000	BEY16C-3	4/24
1SBL397001R1311	AF80-30-11-13	5/111	1SBN010015R1010	CE5-10D0.1	5/338	1SBN033405T1000	BEA65-4	5/8
1SBL397001R1322	AF80-30-22-13	5/111	1SBN010016R1001	CE5-01W0.1	5/338	1SBN083913R2000	BEY96-4	5/60
1SBL397001R1400	AF80-30-00-14	5/86	1SBN010016R1010	CE5-10W0.1	5/338	1SBN083413R2000	BEY65-4	5/60
1SBL397001R1411	AF80-30-11-14	5/111	1SBN010017R1001	CE5-01D2	5/338	1SBN033405T1000	VM96-4	5/89
1SBL397001R1422	AF80-30-22-14	5/111	1SBN010017R1010	CE5-10D2	5/338	1SBN050010R1000	RV5/50	4/37
1SBL397001R4100	AF80-30-00-41	5/86	1SBN010018R1001	CE5-01W2	5/338	1SBN050010R1001	RV5/133	4/37
1SBL397001R4111	AF80-30-11-41	5/111	1SBN010018R1010	CE5-10W2	5/338	1SBN050010R1002	RV5/250	4/37
1SBL397001R4122	AF80-30-22-41	5/111	1SBN010020R1011	CAL5-11	5/376	1SBN050010R1003	RV5/440	4/37
1SBL397201R1100	AF80-40-00-11	5/192	1SBN010040R1004	CA5-04E	5/376	1SBN050020R1000	RT5/32	4/37
1SBL397201R1200	AF80-40-00-12	5/192	1SBN010040R1018	CA5-11/11E	5/376	1SBN050020R1001	RT5/65	4/37
1SBL397201R1300	AF80-40-00-13	5/192	1SBN010040R1022	CA5-22E	5/376	1SBN050020R1002	RT5/90	4/37
1SBL397201R1400	AF80-40-00-14	5/192	1SBN010040R1031	CA5-31E	5/376	1SBN050020R1003	RT5/150	4/37
1SBL397201R4100	AF80-40-00-41	5/192	1SBN010040R1040	CA5-40E	5/376	1SBN050020R1004	RT5/264	4/37
1SBL397501R1100	AF80-22-00-11	5/192	1SBN010040R1104	CA5-04M	5/376	1SBN050100R1000	RC5-1/50	4/37
1SBL397501R1200	AF80-22-00-12	5/192	1SBN010040R1113	CA5-13M	5/376	1SBN050100R1001	RC5-1/133	4/37
1SBL397501R1300	AF80-22-00-13	5/192	1SBN010040R1118	CA5-11/11M	5/376	1SBN050100R1002	RC5-1/250	4/37
1SBL397501R1400	AF80-22-00-14	5/192	1SBN010040R1122	CA5-22M	5/376	1SBN050100R1003	RC5-1/440	4/37
1SBL397501R4100	AF80-22-00-41	5/192	1SBN010040R1131	CA5-31M	5/376	1SBN050200R1000	RC5-2/50	5/389
1SBL407001R1100	AF96-30-00-11	5/6	1SBN083911R1000	BER96-4	5/8	1SBN050200R1001	RC5-2/133	5/389
1SBL407001R1111	AF96-30-11-11	5/111	1SBN010110R1010	CA4-01	5/89	1SBN050200R1002	RC5-2/250	5/389
1SBL407001R1122	AF96-30-22-11	5/111	1SBN083406R1000	BEA65-4	5/6	1SBN050200R1003	RC5-2/440	5/389
1SBL407001R1200	AF96-30-00-12	5/86	1SBN082306T2000	BEA38-4	5/6	1SBN060100R1000	RA4	5/356
1SBL407001R1211	AF96-30-11-12	5/111	1SBN082306T1000	BEA26-4	5/7	1SBN060100T1000	RA4-T	5/356
1SBL407001R1222	AF96-30-22-12	5/111	1SBN083411R1000	BER65-4	5/37	1SBN060300R1000	RA5-1	5/391
1SBL407001R1300	AF96-30-00-13	5/6	1SBN082311R1000	BER38-4	5/37	1SBN060300T1000	RA5-1	5/391
1SBL407001R1311	AF96-30-11-13	5/111	1SBN010110R1010	CA4-10	5/89	1SBN070156T1000	LDC4	5/321
1SBL407001R1322	AF96-30-22-13	5/111	1SBN010110T1001	CA4-01-T	5/89	1SBN070157T1000	LDC4S	6/51
1SBL407001R1400	AF96-30-00-14	5/86	1SBN010110T1010	CA4-10-T	5/89	1SBN071303T1000	LY16-4	5/366
1SBL407001R1411	AF96-30-11-14	5/111	1SBN010111R1001	CC4-01	5/89	1SBN071305R1000	LF16-4	5/366
1SBL407001R1422	AF96-30-22-14	5/111	1SBN010111R1010	CC4-10	5/89	1SBN071306R1000	LG16-4	5/366
1SBL407001R4100	AF96-30-00-41	5/86	1SBN010119R1001	CA4-01S	6/51	1SBN072303T1000	LY38-4	5/366
1SBL407001R4111	AF96-30-11-41	5/111	1SBN010119R1010	CA4-10S	6/51	1SBN072304R1000	LH38-4	5/366
1SBL407001R4122	AF96-30-22-41	5/111	1SBN010119T1001	CA4-01S-T	6/51	1SBN072305R1000	LF38-4	5/366
1SBL411022R8000	UA75-30-00	5/286	1SBN010119T1010	CA4-10S-T	6/51	1SBN072308R1000	LD38-4	5/362
1SBL411022R8011	UA75-30-11	5/287	1SBN010120R1011	CAL4-11	5/89	1SBN073452R1000	LK96-4L	5/364
1SBL411022R8100	UA75-30-00	5/286	1SBN010120T1011	CAL4-11-T	5/89	1SBN073452R2000	LK96-4F	5/364
1SBL411022R8111	UA75-30-11	5/287	1SBN010130R1011	CAL4-11S	6/51	1SBN073452R3000	LK96-4B	5/364
1SBL411022R8300	UA75-30-00	5/286	1SBN010140R1004	CA4-04E	5/195	1SBN073508R1000	LD75	5/395
1SBL411022R8311	UA75-30-11	5/287	1SBN010140R1022	CA4-22E	5/89	1SBN073552R1000	LK75-F	5/396
1SBL411022R8400	UA75-30-00	5/286	1SBN010140R1031	CA4-31E	5/195	1SBN073552R1003	LK75-L	5/396
1SBL411022R8411	UA75-30-11	5/287	1SBN010140R1040	CA4-40E	5/195	1SBN080906R1001	BEA7/325	3/39
1SBL411022R8500	UA75-30-00	5/286	1SBN010140R1104	CA4-04M	5/336	1SBN080906R1002	BEA7/132	3/39
1SBL411022R8511	UA75-30-11	5/287	1SBN010140R1113	CA4-13M	5/336	1SBN081006T1000	BEA16-3	4/10
1SBL411022R8600	UA75-30-00	5/286	1SBN010140R1122	CA4-22M	5/89	1SBN081012R1000	BER16C-3	4/14
1SBL411022R8611	UA75-30-11	5/287	1SBN010140R1131	CA4-31M	5/336	1SBN081018R2000	BEY16C-3	4/24
1SBL411022R8800	UA75-30-00	5/286	1SBN010140R1204	CA4-04N	5/321	1SBN081020R1000	BEA16-3U	6/29
1SBL411022R8811	UA75-30-11	5/287	1SBN010140R1213	CA4-13N	5/321	1SBN081306T1000	BEA16-4	5/6
1SBL411024R8000	UA75-30-00RA	5/277	1SBN010140R1222	CA4-22N	5/321	1SBN081313R2000	BEY16-4	5/60
1SBL411024R8100	UA75-30-00RA	5/277	1SBN010140R1231	CA4-31N	5/321	1SBN082306T1000	BEA26-4	5/7
1SBL411024R8300	UA75-30-00RA	5/277	1SBN010140R1240	CA4-40N	5/321	1SBN082306T2000	BEA38-4	5/6
1SBL411024R8400	UA75-30-00RA	5/277	1SBN010140R1322	CA4-22U	5/89	1SBN082713R2000	BEY38-4	5/60
1SBL411024R8500	UA75-30-00RA	5/277	1SBN010140R1331	CA4-31U	5/336	1SBN083406R1000	BEA65-4	5/6
1SBL411024R8600	UA75-30-00RA	5/277	1SBN010140R1340	CA4-40U	5/336	1SBN083413R2000	BEY65-4	5/60
1SBL411024R8800	UA75-30-00RA	5/277	1SBN010145R1022	CA4-22ES	6/51	1SBN083911R1000	BER96-4	5/8
1SBL411025R8000	GA75-10-00	5/252	1SBN010145R1031	CA4-31ES	6/51	1SBN083913R2000	BEY96-4	5/60
1SBL411025R8011	GA75-10-11	5/252	1SBN010145R1040	CA4-40ES	6/51	1SBN101035R1000	FR16AS-12VARS	8/2
1SBL411025R8100	GA75-10-00	5/252	1SBN010145R1122	CA4-22MS	6/51	1SBN101337R1000	FR16AF-12	8/9
1SBL411025R8111	GA75-10-11	5/252	1SBN010145R1131	CA4-31MS	6/51	1SBN101338R1000	FR16AF-12U	8/9
1SBL411025R8300	GA75-10-00	5/252	1SBN010145R1222	CA4-22NS	6/73	1SBN110000R1000	BA5-50	3/39
1SBL411025R8311	GA75-10-11	5/252	1SBN010145R1231	CA4-31NS	6/73	1SBN110108T1000	BX4	5/321
1SBL411025R8400	GA75-10-00	5/252	1SBN010145R1240	CA4-40NS	6/73	1SBN110109W1000	BX4-CA	5/321
1SBL411025R8411	GA75-10-11	5/252	1SBN010151R1011	CAT4-11E	5/89	1SBN110120W1000	BB4	5/352
1SBL411025R8500	GA75-10-00	5/252	1SBN010151R1111	CAT4-11M	5/89	1SBN110122T1000	BDT4	4/82
1SBL411025R8511	GA75-10-11	5/252	1SBN010151R1311	CAT4-11U	5/89	1SBN11020R1000	BB3	4/82
1SBL411025R8600	GA75-10-00	5/252	1SBN010153R1011	CAT4-11ES	6/51	1SBN111403R1000	BP16	5/388
1SBL411025R8611	GA75-10-11	5/252	1SBN010153R1111	CAT4-11MS	6/51	1SBN112303T1000	BP38-4	5/361
1SBL411025R8800	GA75-10-00	5/252	1SBN010153R1311	CAT4-11US	6/51	1SBN113403T1000	BP65-4	5/361
1SBL411025R8811	GA75-10-11	5/252	1SBN011010T1001	CA3-01	4/37	1SBN113903T1000	BP96-4	5/361
1SBL419025R8000	GAE75-10-00	5/253	1SBN081012R1000	BER16C-3	4/21	1SBN123401R1000	LT65-30	5/363
1SBL419025R8011	GAE75-10-11	5/253	1SBN011010T1010	CA3-10	4/37	1SBN123402R1000	LT52-40	5/363
1SBL419025R8100	GAE75-10-00	5/253	1SBN011019T1001	CA3-01S	6/9	1SBN123901R1000	LT96-30	5/363
1SBL419025R8111	GAE75-10-11	5/253	1SBN011019T1010	CA3-10S	6/9	1SBN123902R1000	LT80-40	5/363
1SBL419025R8300	GAE75-10-00	5/253	1SVR730100R0300	CT-ERS-21S	5/60	1SBN151410R8006	ZA16	5/397
1SBL419025R8311	GAE75-10-11	5/253	1SBN020112R1000	TEF4-ON	5/89	1SBN151410R8106	ZA16	5/397
1SBL419025R8400	GAE75-10-00	5/253	1SBN020113R1000	TEF4S-ON	6/51	1SBN151410R8306	ZA16	5/397
1SBL419025R8411	GAE75-10-11	5/253	1SBN020114R1000	TEF4-OFF	5/89	1SBN151410R8406	ZA16	5/397
1SBL419025R8600	GAE75-10-00	5/253	1SBN020115R1000	TEF4S-OFF	6/51	1SBN151410R8506	ZA16	5/397
1SBL419025R8611	GAE75-10-11	5/253	1SBN020312R1000	TEF5-ON	5/382	1SBN151410R8606	ZA16	5/397
1SBL419025R8700	GAE75-10-00	5/253	1SBN020314R1000	TEF5-OFF	5/382	1SBN151410R8806	ZA16	5/397
1SBL419025R8711	GAE75-10-11	5/253	1SBN021012R1000	TEF3-ON	4/37	1SBN152410R8006	Z440	5/397
1SBL419025R8800	GAE75-10-00	5/253	1SBN021014R1000	TEF3-OFF	4/37	1SBN152410R8106	Z440	5/397
1SBL419025R8811	GAE75-10-11	5/253	1SBN030105T1000	VM4	5/89	1SBN152410R8306	Z440	5/397
1SBL419025R8900	GAE75-10-00	5/253	1SBN081306T1000	BEA16-4	5/8	1SBN152410R8406	Z440	5/397
1SBL419025R8911	GAE75-10-11	5/253	1SBN091311R1000	BER16-4	5/37	1SBN152410R8506	Z440	5/397
1SBN010010R1001	CA5-01	5/376	1SBN082713R2000	BEY38-4	5/60	1SBN152410R8606	Z440	5/397
1SBN010010R1010	CA5-10	5/376	1SBN081313R2000	BEY16-4	5/60	1SBN152410R8806	Z440	5/397
1SBN010011R1001	CC5-01	5/376	1SBN030111R1000	VEM4	5/89	1SBN153510R8006	ZA75	5/397
1SBN010011R1010	CC5-10	5/376	1SBN030210R1000	VE5-2	5/385	1SBN153510R8106	ZA75	5/397

Index

Order code classification

Order code	Type	Page	Order code	Type	Page	Order code	Type	Page
1SFL487102R1122	AF190-40-22-11	5/205	1SFL587002R1311	AF305-30-11-13	5/20	1SFL647001R7111	AF1250-30-11	5/103
1SFL487102R1200	AF190-40-00-12	5/197	1SFL587002R1322	AF305-30-22-13	5/116	1SFL647001R7122	AF1250-30-22	5/121
1SFL487102R1211	AF190-40-11-12	5/201	1SFL587002R1400	AF305-30-00-14	5/92	1SFL647025R6811	GAF1250-10-11	5/256
1SFL487102R1222	AF190-40-22-12	5/205	1SFL587002R1411	AF305-30-11-14	5/98	1SFL647025R6911	GAF1250-10-11	5/256
1SFL487102R1300	AF190-40-00-13	5/197	1SFL587002R1422	AF305-30-22-14	5/116	1SFL647025R7011	GAF1250-10-11	5/256
1SFL487102R1311	AF190-40-11-13	5/201	1SFL587002R3300	AF305-30-00-33	5/93	1SFL647025R7111	GAF1250-10-11	5/256
1SFL487102R1322	AF190-40-22-13	5/205	1SFL587002R3311	AF305-30-11-33	5/99	1SFL657001R7011	AF1350-30-11	5/103
1SFL487102R1400	AF190-40-00-14	5/197	1SFL587002R3322	AF305-30-22-33	5/117	1SFL657001R7022	AF1350-30-22	5/121
1SFL487102R1411	AF190-40-11-14	5/201	1SFL587002R3400	AF305-30-00-34	5/93	1SFL657001R9101	AF1350-30T-11	5/105
1SFL487102R1422	AF190-40-22-14	5/205	1SFL587002R3411	AF305-30-11-34	5/99	1SFL667001R7011	AF2650-30-11	5/103
1SFL497025R6911	GAF185-10-11	5/254	1SFL587002R3422	AF305-30-22-34	5/117	1SFL667001R7022	AF2650-30-22	5/121
1SFL497025R7011	GAF185-10-11	5/254	1SFL587102R1100	AF305-40-00-11	5/197	1SFL667001R9101	AF2650-30T-11	5/105
1SFL497025R7211	GAF185-10-11	5/254	1SFL587102R1111	AF305-40-11-11	5/201	1SFL677001R7011	AF1650-30-11	5/103
1SFL527002R1100	AF205-30-00-11	5/92	1SFL587102R1122	AF305-40-22-11	5/205	1SFL677001R7022	AF1650-30-22	5/121
1SFL527002R1111	AF205-30-11-11	5/20	1SFL587102R1200	AF305-40-00-12	5/197	1SFL677001R9101	AF1650-30T-11	5/105
1SFL527002R1122	AF205-30-22-11	5/116	1SFL587102R1211	AF305-40-11-12	5/201	1SFL677025R7011	GAF1650-10-11	5/256
1SFL527002R1200	AF205-30-00-12	5/92	1SFL587102R1222	AF305-40-22-12	5/205	1SFL707001R7011	AF2050-30-11	5/103
1SFL527002R1211	AF205-30-11-12	5/98	1SFL587102R1300	AF305-40-00-13	5/197	1SFL707001R7022	AF2050-30-22	5/121
1SFL527002R1222	AF205-30-22-12	5/116	1SFL587102R1311	AF305-40-11-13	5/201	1SFL707001R9101	AF2050-30T-11	5/105
1SFL527002R1300	AF205-30-00-13	5/92	1SFL587102R1322	AF305-40-22-13	5/205	1SFL707025R7011	GAF2050-10-11	5/256
1SFL527002R1311	AF205-30-11-13	5/20	1SFL587102R1400	AF305-40-00-14	5/197	1SFN010716R1001	CEL18-01	5/257
1SFL527002R1322	AF205-30-22-13	5/116	1SFL587102R1411	AF305-40-11-14	5/201	1SFN010716R1010	CEL18-10	5/257
1SFL527002R1400	AF205-30-00-14	5/92	1SFL587102R1422	AF305-40-22-14	5/205	1SFN010720R1011	CAL18-11	5/107
1SFL527002R1411	AF205-30-11-14	5/98	1SFL597001R6811	AF460-30-11	5/102	1SFN010720R3311	CAL18-11B	5/107
1SFL527002R1422	AF205-30-22-14	5/116	1SFL597001R6822	AF460-30-22	5/120	1SFN010820R1011	CAL19-11	5/95
1SFL527002R3300	AF205-30-00-33	5/93	1SFL597001R6911	AF460-30-11	5/102	1SFN010820R3311	CAL19-11B	5/95
1SFL527002R3311	AF205-30-11-33	5/99	1SFL597001R6922	AF460-30-22	5/120	1SFN010832R1001	CEL19-01	5/344
1SFL527002R3322	AF205-30-22-33	5/117	1SFL597001R7011	AF460-30-11	5/102	1SFN010832R1010	CEL19-10	5/344
1SFL527002R3400	AF205-30-00-34	5/93	1SFL597001R7022	AF460-30-22	5/120	1SFR084811R1000	BER205-4	5/37
1SFL527002R3411	AF205-30-11-34	5/99	1SFL597001R7111	AF460-30-11	5/102	1SFN084211R1000	BER140-4	5/37
1SFL527002R3422	AF205-30-22-34	5/117	1SFL597001R7122	AF460-30-22	5/120	1SFN085411R1000	BER370-4	5/39
1SFL527102R1100	AF205-40-00-11	5/197	1SFL597025R6811	GAF460-10-11	5/255	1SFN084413R1000	BEY140-4	5/60
1SFL527102R1111	AF205-40-11-11	5/201	1SFL597025R6911	GAF460-10-11	5/255	1SFN085813R1000	BEY370-4	5/62
1SFL527102R1122	AF205-40-22-11	5/205	1SFL597025R7011	GAF460-10-11	5/255	1SFN085213R1000	BEY205-4	5/62
1SFL527102R1200	AF205-40-00-12	5/197	1SFL597025R7111	GAF460-10-11	5/255	1SFN030300R1000	VM19	5/95
1SFL527102R1211	AF205-40-11-12	5/201	1SFL607002R1100	AF370-30-00-11	5/92	1SFN034403R1000	BEY190-4	5/60
1SFL527102R1222	AF205-40-22-12	5/205	1SFL607002R1111	AF370-30-11-11	5/22	1SFN034403R1000	VM140/190	5/95
1SFL527102R1300	AF205-40-00-13	5/197	1SFL607002R1122	AF370-30-22-11	5/116	1SFN085413R1000	BEY265-4	5/62
1SFL527102R1311	AF205-40-11-13	5/201	1SFL607002R1200	AF370-30-00-12	5/92	1SFN035203R1000	VM205/265	5/95
1SFL527102R1322	AF205-40-22-13	5/205	1SFL607002R1211	AF370-30-11-12	5/98	1SFN035700R1000	VM750H	5/107
1SFL527102R1400	AF205-40-00-14	5/197	1SFL607002R1222	AF370-30-22-12	5/116	1SFN035701R1000	VM750V	5/352
1SFL527102R1411	AF205-40-11-14	5/201	1SFL607002R1300	AF370-30-00-13	5/92	1SFN036503R1000	VM1650H	5/107
1SFL527102R1422	AF205-40-22-14	5/205	1SFL607002R1311	AF370-30-11-13	5/22	1SFN036503R1001	VM1650H	5/352
1SFL547002R1100	AF265-30-00-11	5/92	1SFL607002R1322	AF370-30-22-13	5/116	1SFN074203R1000	LY140	5/366
1SFL547002R1111	AF265-30-11-11	5/20	1SFL607002R1400	AF370-30-00-14	5/92	1SFN074207R1000	LW140	5/95
1SFL547002R1122	AF265-30-22-11	5/116	1SFL607002R1411	AF370-30-11-14	5/98	1SFN074208R1000	LD146-30	5/365
1SFL547002R1200	AF265-30-00-12	5/92	1SFL607002R1422	AF370-30-22-14	5/116	1SFN074208R2000	LD146-40	5/365
1SFL547002R1211	AF265-30-11-12	5/98	1SFL607002R3300	AF370-30-00-33	5/93	1SFN074210R1000	LX140	5/95
1SFL547002R1222	AF265-30-22-12	5/116	1SFL607002R3311	AF370-30-11-33	5/99	1SFN074211R1000	LL146-30	5/365
1SFL547002R1300	AF265-30-00-13	5/92	1SFL607002R3322	AF370-30-22-33	5/117	1SFN074211R2000	LL146-40	5/365
1SFL547002R1311	AF265-30-11-13	5/20	1SFL607002R3400	AF370-30-00-34	5/93	1SFN074307R1000	LW110	5/395
1SFL547002R1322	AF265-30-22-13	5/116	1SFL607002R3411	AF370-30-11-34	5/99	1SFN074703R1000	LY185	5/366
1SFL547002R1400	AF265-30-00-14	5/92	1SFL607002R3422	AF370-30-22-34	5/117	1SFN074712R1000	LP185	5/257
1SFL547002R1411	AF265-30-11-14	5/98	1SFL607102R1100	AF370-40-00-11	5/197	1SFN074807R1000	LW205	5/95
1SFL547002R1422	AF265-30-22-14	5/116	1SFL607102R1111	AF370-40-11-11	5/201	1SFN074807R2000	LW205-40	5/199
1SFL547002R3300	AF265-30-00-33	5/93	1SFL607102R1122	AF370-40-22-11	5/205	1SFN074810R1000	LX205	5/95
1SFL547002R3311	AF265-30-11-33	5/99	1SFL607102R1200	AF370-40-00-12	5/197	1SFN074811R2000	LL205-40	5/365
1SFL547002R3322	AF265-30-22-33	5/117	1SFL607102R1211	AF370-40-11-12	5/201	1SFN075103R1000	LY300	5/366
1SFL547002R3400	AF265-30-00-34	5/93	1SFL607102R1222	AF370-40-22-12	5/205	1SFN075112R1000	LP300	5/257
1SFL547002R3411	AF265-30-11-34	5/99	1SFL607102R1300	AF370-40-00-13	5/197	1SFN075407R1000	LW370	5/95
1SFL547002R3422	AF265-30-22-34	5/117	1SFL607102R1311	AF370-40-11-13	5/201	1SFN075407R2000	LW370-40	5/199
1SFL547102R1100	AF265-40-00-11	5/197	1SFL607102R1322	AF370-40-22-13	5/205	1SFN075410R1000	LX370	5/95
1SFL547102R1111	AF265-40-11-11	5/201	1SFL607102R1400	AF370-40-00-14	5/197	1SFN075411R2000	LL370-40	5/365
1SFL547102R1122	AF265-40-22-11	5/205	1SFL607102R1411	AF370-40-11-14	5/201	1SFN075703R1000	LY460	5/366
1SFL547102R1200	AF265-40-00-12	5/197	1SFL607102R1422	AF370-40-22-14	5/205	1SFN075707R1000	LW460	5/107
1SFL547102R1211	AF265-40-11-12	5/201	1SFL617001R6811	AF580-30-11	5/102	1SFN075710R1000	LX460	5/107
1SFL547102R1222	AF265-40-22-12	5/205	1SFL617001R6822	AF580-30-22	5/120	1SFN075712R1000	LP460	5/257
1SFL547102R1300	AF265-40-00-13	5/197	1SFL617001R6911	AF580-30-11	5/102	1SFN076103R1000	LY750	5/366
1SFL547102R1311	AF265-40-11-13	5/201	1SFL617001R6922	AF580-30-22	5/120	1SFN076107R1000	LW750	5/107
1SFL547102R1322	AF265-40-22-13	5/205	1SFL617001R7011	AF580-30-11	5/102	1SFN076110R1000	LX750	5/107
1SFL547102R1400	AF265-40-00-14	5/197	1SFL617001R7022	AF580-30-22	5/120	1SFN076112R1000	LP750	5/257
1SFL547102R1411	AF265-40-11-14	5/201	1SFL617001R7111	AF580-30-11	5/102	1SFN076407R1000	LW1250	5/107
1SFL547102R1422	AF265-40-22-14	5/205	1SFL617001R7122	AF580-30-22	5/120	1SFN076412R1000	LP1250	5/257
1SFL557025R6911	GAF300-10-11	5/254	1SFL637001R6811	AF750-30-11	5/102	1SFN076512R1000	LP2050	5/257
1SFL557025R7011	GAF300-10-11	5/254	1SFL637001R6822	AF750-30-22	5/120	1SFN084206R1000	BEA140/XT2	5/20
1SFL557025R7211	GAF300-10-11	5/254	1SFL637001R6911	AF750-30-11	5/102	1SFN084206R1001	BEA140/XT4	5/369
1SFL577001R6811	AF400-30-11	5/102	1SFL637001R6922	AF750-30-22	5/120	1SFN084211R1000	BER140-4	5/37
1SFL577001R6822	AF400-30-22	5/120	1SFL637001R7011	AF750-30-11	5/102	1SFN084214R1000	BEP140-30	5/367
1SFL577001R6911	AF400-30-11	5/102	1SFL637001R7022	AF750-30-22	5/120	1SFN084214R2000	BEP140-40	5/367
1SFL577001R6922	AF400-30-22	5/120	1SFL637001R7111	AF750-30-11	5/102	1SFN084413R1000	BEY140-4	5/60
1SFL577001R7011	AF400-30-11	5/102	1SFL637001R7122	AF750-30-22	5/120	1SFN084806R1000	BEA205/XT4	5/20
1SFL577001R7022	AF400-30-22	5/120	1SFL637025R6811	GAF750-10-11	5/255	1SFN084806R1001	BEA205/T4	5/20
1SFL577001R7111	AF400-30-11	5/102	1SFL637025R6911	GAF750-10-11	5/255	1SFN084811R1000	BER205-4	5/37
1SFL577001R7122	AF400-30-22	5/120	1SFL637025R7011	GAF750-10-11	5/255	1SFN084813R1000	BEY190-4	5/60
1SFL587002R1100	AF305-30-00-11	5/92	1SFL637025R7111	GAF750-10-11	5/255	1SFN084814R1000	BEP205-30	5/367
1SFL587002R1111	AF305-30-11-11	5/20	1SFL647001R6811	AF1250-30-11	5/103	1SFN084814R2000	BEP205-40	5/367
1SFL587002R1122	AF305-30-22-11	5/116	1SFL647001R6822	AF1250-30-22	5/121	1SFN085213R1000	BEY205-4	5/62
1SFL587002R1200	AF305-30-00-12	5/92	1SFL647001R6911	AF1250-30-11	5/103	1SFN085406R1000	BEA370/T5	5/20
1SFL587002R1211	AF305-30-11-12	5/98	1SFL647001R6922	AF1250-30-22				

Index

Order code classification

Order code	Type	Page
1SFN085414R2000	BEP370-40	5/367
1SFN085701R1000	BEM460-30	5/367
1SFN085703R1000	BED460	5/368
1SFN085704R1000	BES460	5/367
1SFN085708R1000	BEF460/OESA400	5/369
1SFN085709R1000	OESA460H/OESA400	5/369
1SFN085813R1000	BEY370-4	5/62
1SFN085903R1000	BED580	5/368
1SFN085907R1000	BEA460H/T4	5/369
1SFN086101R1000	BEM750-30	5/367
1SFN086103R1000	BED750	5/368
1SFN086104R1000	BES750	5/367
1SFN086106R1000	BEA750/T6	5/369
1SFN086106R1001	BEA750/T5	5/369
1SFN086106R1002	BEA750D/T6	5/369
1SFN086106R1003	BEA750D/T5	5/369
1SFN086108R1000	BEF750/OESA800	5/369
1SFN094200R1000	PR146-1	5/371
1SFN094900R1000	PR210-1	5/371
1SFN095100R1001	PR185-2	5/371
1SFN095300R1000	PR300-1	5/371
1SFN095300R1001	PR300-2	5/371
1SFN095700R1000	PR460-1	5/371
1SFN095700R1001	PR460-2	5/371
1SFN095700R1002	PR400-2	5/371
1SFN095701R1000	PN460-21	5/370
1SFN095703R1000	PN460-41	5/370
1SFN095705R1000	PN460-11	5/370
1SFN096100R1000	PR750-1	5/371
1SFN096100R1001	PR750-2	5/371
1SFN096100R1002	PR580-2	5/371
1SFN096101R1000	PN750-21	5/370
1SFN096103R1000	PN750-41	5/370
1SFN096105R1000	PN750-11	5/370
1SFN124203R1000	LT140-30L	5/95
1SFN124203R2000	LT140-40L	5/199
1SFN124801R1000	LT205-30C	5/95
1SFN124801R2000	LT205-40C	5/199
1SFN124803R1000	LT205-30L	5/95
1SFN124803R2000	LT205-40L	5/199
1SFN124804R1000	LT205-30Y	5/95
1SFN125401R1000	LT370-30C	5/95
1SFN125401R2000	LT370-40C	5/199
1SFN125403R1000	LT370-30L	5/95
1SFN125403R2000	LT370-40L	5/199
1SFN125404R1000	LT370-30Y	5/95
1SFN125406R1000	LT370-30D	5/95
1SFN125701R1000	LT460-AC	5/107
1SFN125703R1000	LT460-AL	5/107
1SFN126101R1000	LT750-AC	5/107
1SFN126103R1000	LT750-AL	5/107
1SFN154310R8006	ZA110	5/397
1SFN154310R8106	ZA110	5/397
1SFN154310R8306	ZA110	5/397
1SFN154310R8406	ZA110	5/397
1SFN154310R8506	ZA110	5/397
1SFN154310R8606	ZA110	5/397
1SFN154310R8806	ZA110	5/397
1SFN155770R6906	ZAF460	5/373
1SFN155770R6906	ZAF460	5/373
1SFN155770R7006	ZAF460	5/373
1SFN155770R7106	ZAF460	5/373
1SFN156170R6806	ZAF750	5/373
1SFN156170R6906	ZAF750	5/373
1SFN156170R7006	ZAF750	5/373
1SFN156170R7106	ZAF750	5/373
1SFN156570R7026	ZAF1650	5/373
1SFN156670R7026	ZAF2650	5/373
1SFN164302R1000	ZLU95	5/397
1SFN164502R1000	ZLU110	5/397
1SFN165703R1000	ZL400	5/373
1SFN165710R1000	ZW460	5/373
1SFN165903R1000	ZL460	5/373
1SFN166103R1000	ZL580	5/373
1SFN166110R1000	ZW750	5/373
1SFN166303R1000	ZL750	5/373
1SFN166403R1000	ZL1250	5/373
1SFN166503R1000	ZL1350	5/373
1SFN166503R1001	ZL1350-1	5/373
1SFN166510R1000	ZW1650	5/373
1SFN166521R1070	ZP1650	5/373
1SFN166603R1000	ZL2650	5/373
1SFN166610R1000	ZW2650	5/373
1SFN166621R1070	ZP2650	5/373
1SFN166703R1000	ZL1650	5/373
1SFN166703R1001	ZL1650-1	5/373
1SFN167003R1000	ZL2050	5/373
1SFN167003R1001	ZL2050-1	5/373
1SFN170801R1001	RU19/120	5/372
1SFN170801R1002	RU19/240	5/372

Order code	Type	Page
1SNA235156R2700	BA4	4/82
1SNA235712R2400	HTP500-BA4	4/82
1SNA360010R1500	SPRC 1	4/82
1SVR730100R0300	CT-ERS.21S	5/60
1SVR730210R3300	CT-SDS.22S	4/25
1SVR730211R2300	CT-SDS.23S	4/25
5223351-AN	KWK1000	5/408
5223351-Z	KWK550	5/408
FPTN372726R1001	WB75-A	5/358
FPTN372726R1002	WB75-A	5/358
FPTN372726R1003	WB75-A	5/358
FPTN372726R1004	WB75-A	5/358
FPTN372726R1005	WB75-A	5/358
FPTN372726R1006	WB75-A	5/358
FPTN372726R1007	WB75-A	5/358
FPTN372726R1008	WB75-A	5/358
GHV2501902R0002	RV-BC6/60	3/39
GHV2501902R0003	RV-BC6-F/60	3/39
GHV2501903R0002	RV-BC6/250	3/39
GHV2501903R0003	RV-BC6-F/250	3/39
GHV2501904R0002	RV-BC6/380	3/39
GHV2501904R0003	RV-BC6-F/380	3/39
GJF1101903R0001	SA1	2/28
GJF1101903R0002	SA2	2/28
GJF1101903R0003	SA3	2/28
GJH1211001R0221	K6-22Z-01	3/15
GJH1211001R0222	K6-22Z-02	3/15
GJH1211001R0223	K6-22Z-03	3/15
GJH1211001R0311	K6-31Z-01	3/15
GJH1211001R0312	K6-31Z-02	3/15
GJH1211001R0313	K6-31Z-03	3/15
GJH1211001R0401	K6-40E-01	3/15
GJH1211001R0402	K6-40E-02	3/15
GJH1211001R0403	K6-40E-03	3/15
GJH1211001R0404	K6-40E-04	3/15
GJH1211001R8220	K6-22Z-80	3/15
GJH1211001R8224	K6-22Z-84	3/15
GJH1211001R8225	K6-22Z-85	3/15
GJH1211001R8310	K6-31Z-80	3/15
GJH1211001R8314	K6-31Z-84	3/15
GJH1211001R8315	K6-31Z-85	3/15
GJH1211001R8400	K6-40E-80	3/15
GJH1211001R8404	K6-40E-84	3/15
GJH1211001R8405	K6-40E-85	3/15
GJH1211003R0221	K6-22Z-F-01	3/36
GJH1211003R0222	K6-22Z-F-02	3/36
GJH1211003R0223	K6-22Z-F-03	3/36
GJH1211003R0311	K6-31Z-F-01	3/36
GJH1211003R0312	K6-31Z-F-02	3/36
GJH1211003R0313	K6-31Z-F-03	3/36
GJH1211003R0401	K6-40E-F-01	3/36
GJH1211003R0402	K6-40E-F-02	3/36
GJH1211003R0403	K6-40E-F-03	3/36
GJH1211003R8220	K6-22Z-F-80	3/36
GJH1211003R8224	K6-22Z-F-84	3/36
GJH1211003R8225	K6-22Z-F-85	3/36
GJH1211003R8310	K6-31Z-F-80	3/36
GJH1211003R8314	K6-31Z-F-84	3/36
GJH1211003R8315	K6-31Z-F-85	3/36
GJH1211003R8400	K6-40E-F-80	3/36
GJH1211003R8404	K6-40E-F-84	3/36
GJH1211003R8405	K6-40E-F-85	3/36
GJH1211009R0221	K6-22Z-P-01	3/25
GJH1211009R0222	K6-22Z-P-02	3/25
GJH1211009R0223	K6-22Z-P-03	3/25
GJH1211009R0311	K6-31Z-P-01	3/25
GJH1211009R0312	K6-31Z-P-02	3/25
GJH1211009R0313	K6-31Z-P-03	3/25
GJH1211009R0401	K6-40E-P-01	3/25
GJH1211009R0402	K6-40E-P-02	3/25
GJH1211009R0403	K6-40E-P-03	3/25
GJH1211009R8220	K6-22Z-P-80	3/25
GJH1211009R8224	K6-22Z-P-84	3/25
GJH1211009R8225	K6-22Z-P-85	3/25
GJH1211009R8310	K6-31Z-P-80	3/25
GJH1211009R8314	K6-31Z-P-84	3/25
GJH1211009R8315	K6-31Z-P-85	3/25
GJH1211009R8400	K6-40E-P-80	3/25
GJH1211009R8404	K6-40E-P-84	3/25
GJH1211009R8405	K6-40E-P-85	3/25
GJH1213001R0221	KC6-22Z-01	3/16
GJH1213001R0223	KC6-22Z-03	3/16
GJH1213001R0224	KC6-22Z-04	3/16
GJH1213001R0225	KC6-22Z-05	3/16
GJH1213001R0227	KC6-22Z-07	3/16
GJH1213001R0311	KC6-31Z-01	3/16
GJH1213001R0313	KC6-31Z-03	3/16
GJH1213001R0314	KC6-31Z-04	3/16
GJH1213001R0315	KC6-31Z-05	3/16
GJH1213001R0317	KC6-31Z-07	3/16
GJH1213001R0401	KC6-40E-01	3/16

Order code	Type	Page
GJH1213001R0403	KC6-40E-03	3/16
GJH1213001R0404	KC6-40E-04	3/16
GJH1213001R0405	KC6-40E-05	3/16
GJH1213001R0407	KC6-40E-07	3/16
GJH1213001R1226	KC6-22Z-16	3/16
GJH1213001R1316	KC6-31Z-16	3/16
GJH1213001R1406	KC6-40E-16	3/16
GJH1213001R5311	KC6-31Z-2.4-51	3/17
GJH1213001R5401	KC6-40E-2.4-51	3/17
GJH1213001R7221	K6S-22Z-1.7-71	3/17
GJH1213001R7222	K6S-22Z-2.8-72	3/17
GJH1213001R7311	K6S-31Z-1.7-71	3/17
GJH1213001R7312	K6S-31Z-2.8-72	3/17
GJH1213001R7401	K6S-40E-1.7-71	3/17
GJH1213001R7402	K6S-40E-2.8-72	3/17
GJH1213001R8311	KC6-31Z-1.4-81	3/17
GJH1213001R8401	KC6-40E-1.4-81	3/17
GJH1213003R0221	KC6-22Z-F-01	3/37
GJH1213003R0224	KC6-22Z-F-04	3/37
GJH1213003R0225	KC6-22Z-F-05	3/37
GJH1213003R0227	KC6-22Z-F-07	3/37
GJH1213003R0311	KC6-31Z-F-01	3/37
GJH1213003R0314	KC6-31Z-F-04	3/37
GJH1213003R0315	KC6-31Z-F-05	3/37
GJH1213003R0317	KC6-31Z-F-07	3/37
GJH1213003R0401	KC6-40E-F-01	3/37
GJH1213003R0404	KC6-40E-F-04	3/37
GJH1213003R0405	KC6-40E-F-05	3/37
GJH1213003R1226	KC6-22Z-F-16	3/37
GJH1213003R1316	KC6-31Z-F-16	3/37
GJH1213003R1406	KC6-40E-F-16	3/37
GJH1213003R5311	KC6-31Z-F-51	3/38
GJH1213003R5401	KC6-40E-F-51	3/38
GJH1213003R8311	KC6-31Z-F-1.4-81	3/38
GJH1213003R8401	KC6-40E-F-1.4-81	3/38
GJH1213009R0221	KC6-22Z-P-01	3/26
GJH1213009R0224	KC6-22Z-P-04	3/26
GJH1213009R0225	KC6-22Z-P-05	3/26
GJH1213009R0227	KC6-22Z-P-07	3/26
GJH1213009R0311	KC6-31Z-P-01	3/26
GJH1213009R0314	KC6-31Z-P-04	3/26
GJH1213009R0315	KC6-31Z-P-05	3/26
GJH1213009R0401	KC6-40E-P-01	3/26
GJH1213009R0404	KC6-40E-P-04	3/26
GJH1213009R0405	KC6-40E-P-05	3/26
GJH1213009R0407	KC6-40E-P-07	3/26
GJH1213009R1226	KC6-22Z-P-16	3/26
GJH1213009R1316	KC6-31Z-P-16	3/26
GJH1213009R1406	KC6-40E-P-16	3/26
GJH1213009R5311	KC6-31Z-P-2.4-51	3/28
GJH1213009R5401	KC6-40E-P-2.4-51	3/28
GJH1213009R8311	KC6-31Z-P-1.4-81	3/28
GJH1213009R8401	KC6-40E-P-1.4-81	3/28
GJH1213061R5221	TKC6-22Z-51	3/18
GJH1213061R5225	TKC6-22Z-55	3/18
GJH1213061R5311	TKC6-31Z-51	3/18
GJH1213061R5315	TKC6-31Z-55	3/18
GJH1213061R5401	TKC6-40E-51	3/18
GJH1213061R5405	TKC6-40E-55	3/18
GJH1213061R6222	TKC6-22Z-62	3/18
GJH1213061R6228	TKC6-22Z-68	3/18
GJH1213061R6312	TKC6-31Z-62	3/18
GJH1213061R6318	TKC6-31Z-68	3/18
GJH1213061R6402	TKC6-40E-62	3/18
GJH1213061R6408	TKC6-40E-68	3/18
GJL1201317R0001	CA6-11K	3/40
GJL1201317R0002	CA6-11E	3/39
GJL1201317R0003	CA6-11M	3/39
GJL1201317R0004	CA6-11N	3/39
GJL1201318R0001	CA6-11K-F	3/40
GJL1201318R0020	CA6-11E-F	3/39
GJL1201318R0003	CA6-11M-F	3/39
GJL1201318R0004	CA6-11N-F	3/39
GJL1201319R0001	CA6-11K-P	3/40
GJL1201319R0002	CA6-11E-P	3/39
GJL1201319R0003	CA6-11M-P	3/39
GJL1201319R0004	CA6-11N-P	3/39
GJL1201330R0001	CAF6-11K	3/40
GJL1201330R0002	CAF6-11E	3/39
GJL1201330R0003	CAF6-11M	3/39
GJL1201330R0004	CAF6-11N	3/39

Index

Order code classification

Order code	Type	Page	Order code	Type	Page	Order code	Type	Page
GJL1201903R0001	LB6-CA	3/39	GJL1211919R0103	VB6A-30-10-P-03	3/23	GJL1213909R0104	VBC6-30-10-P-04	3/22
GJL1201906R0001	LT6-B	3/39	GJL1211919R8010	VB6A-30-01-P-80	3/23	GJL1213909R0105	VBC6-30-10-P-05	3/22
GJL1201907R0001	LP6	3/39	GJL1211919R8014	VB6A-30-01-P-84	3/23	GJL1213909R0106	VBC6-30-10-P-06	3/22
GJL1201908R0001	BSM6-30	3/39	GJL1211919R8015	VB6A-30-01-P-85	3/23	GJL1213909R0107	VBC6-30-10-P-07	3/22
GJL1211001R0011	B6-30-01-01	3/4	GJL1211919R8100	VB6A-30-10-P-80	3/23	GJL1213911R0011	VBC6A-30-01-01	3/9
GJL1211001R0012	B6-30-01-02	3/4	GJL1211919R8104	VB6A-30-10-P-84	3/23	GJL1213911R0013	VBC6A-30-01-03	3/9
GJL1211001R0013	B6-30-01-03	3/4	GJL1211919R8105	VB6A-30-10-P-85	3/23	GJL1213911R0014	VBC6A-30-01-04	3/9
GJL1211001R0101	B6-30-10-01	3/4	GJL1213001R0011	BC6-30-01-01	3/5	GJL1213911R0015	VBC6A-30-01-05	3/9
GJL1211001R0102	B6-30-10-02	3/4	GJL1213001R0013	BC6-30-01-03	3/5	GJL1213911R0017	VBC6A-30-01-07	3/9
GJL1211001R0103	B6-30-10-03	3/4	GJL1213001R0014	BC6-30-01-04	3/5	GJL1213911R0101	VBC6A-30-10-01	3/9
GJL1211001R8010	B6-30-01-80	3/4	GJL1213001R0015	BC6-30-01-05	3/5	GJL1213911R0103	VBC6A-30-10-03	3/9
GJL1211001R8014	B6-30-01-84	3/4	GJL1213001R0017	BC6-30-01-07	3/5	GJL1213911R0104	VBC6A-30-10-04	3/9
GJL1211001R8015	B6-30-01-85	3/4	GJL1213001R0101	BC6-30-10-01	3/5	GJL1213911R0105	VBC6A-30-10-05	3/9
GJL1211001R8100	B6-30-10-80	3/4	GJL1213001R0103	BC6-30-10-03	3/5	GJL1213911R0107	VBC6A-30-10-07	3/9
GJL1211001R8104	B6-30-10-84	3/4	GJL1213001R0104	BC6-30-10-04	3/5	GJL1213911R0106	VBC6A-30-01-16	3/9
GJL1211001R8105	B6-30-10-85	3/4	GJL1213001R0105	BC6-30-10-05	3/5	GJL1213911R1106	VBC6A-30-10-16	3/9
GJL1211003R0011	B6-30-01-F-01	3/29	GJL1213001R0107	BC6-30-10-07	3/5	GJL1311001R0011	B7-30-01-01	3/4
GJL1211003R0012	B6-30-01-F-02	3/29	GJL1213001R0106	BC6-30-01-16	3/5	GJL1311001R0012	B7-30-01-02	3/4
GJL1211003R0013	B6-30-01-F-03	3/29	GJL1213001R1106	BC6-30-10-16	3/5	GJL1311001R0013	B7-30-01-03	3/4
GJL1211003R0101	B6-30-10-F-01	3/29	GJL1213001R5011	BC6-30-01-2.4-51	3/10	GJL1311001R0101	B7-30-10-01	3/4
GJL1211003R0102	B6-30-10-F-02	3/29	GJL1213001R5101	BC6-30-10-2.4-51	3/10	GJL1311001R0102	B7-30-10-02	3/4
GJL1211003R0103	B6-30-10-F-03	3/29	GJL1213001R7011	B6S-30-01-1.7-71	3/10	GJL1311001R0103	B7-30-10-03	3/4
GJL1211003R8010	B6-30-01-F-80	3/29	GJL1213001R7012	B6S-30-01-2.8-72	3/10	GJL1311001R8010	B7-30-01-80	3/4
GJL1211003R8014	B6-30-01-F-84	3/29	GJL1213001R7101	B6S-30-10-1.7-71	3/10	GJL1311001R8014	B7-30-01-84	3/4
GJL1211003R8015	B6-30-01-F-85	3/29	GJL1213001R7102	B6S-30-10-2.8-72	3/10	GJL1311001R8015	B7-30-01-85	3/4
GJL1211003R8100	B6-30-10-F-80	3/29	GJL1213001R8011	BC6-30-01-1.4-81	3/10	GJL1311001R8100	B7-30-10-80	3/4
GJL1211003R8104	B6-30-10-F-84	3/29	GJL1213001R8101	BC6-30-10-1.4-81	3/10	GJL1311001R8104	B7-30-10-84	3/4
GJL1211003R8105	B6-30-10-F-85	3/29	GJL1213003R0011	BC6-30-01-F-01	3/30	GJL1311001R8105	B7-30-10-85	3/4
GJL1211009R0011	B6-30-01-P-01	3/19	GJL1213003R0013	BC6-30-01-F-03	3/30	GJL1311003R0011	B7-30-01-F-01	3/29
GJL1211009R0012	B6-30-01-P-02	3/19	GJL1213003R0014	BC6-30-01-F-04	3/30	GJL1311003R0012	B7-30-01-F-02	3/29
GJL1211009R0013	B6-30-01-P-03	3/19	GJL1213003R0015	BC6-30-01-F-05	3/30	GJL1311003R0013	B7-30-01-F-03	3/29
GJL1211009R0101	B6-30-10-P-01	3/19	GJL1213003R0017	BC6-30-01-F-07	3/30	GJL1311003R0101	B7-30-10-F-01	3/29
GJL1211009R0102	B6-30-10-P-02	3/19	GJL1213003R0101	BC6-30-10-F-01	3/30	GJL1311003R0102	B7-30-10-F-02	3/29
GJL1211009R0103	B6-30-10-P-03	3/19	GJL1213003R0103	BC6-30-10-F-03	3/30	GJL1311003R0103	B7-30-10-F-03	3/29
GJL1211009R8010	B6-30-01-P-80	3/19	GJL1213003R0104	BC6-30-10-F-04	3/30	GJL1311003R8010	B7-30-01-F-80	3/29
GJL1211009R8014	B6-30-01-P-84	3/19	GJL1213003R0105	BC6-30-10-F-05	3/30	GJL1311003R8014	B7-30-01-F-84	3/29
GJL1211009R8105	B6-30-01-P-85	3/19	GJL1213003R0107	BC6-30-10-F-07	3/30	GJL1311003R8015	B7-30-01-F-85	3/29
GJL1211009R8100	B6-30-10-P-80	3/19	GJL1213003R1016	BC6-30-01-F-16	3/30	GJL1311009R8100	B7-30-10-F-80	3/29
GJL1211009R8104	B6-30-10-P-84	3/19	GJL1213003R1106	BC6-30-10-F-16	3/30	GJL1311009R8104	B7-30-10-F-84	3/29
GJL1211009R8105	B6-30-10-P-85	3/19	GJL1213003R5011	BC6-30-01-F-2.4-51	3/35	GJL1311003R8105	B7-30-10-F-85	3/29
GJL1212101R0001	B6-40-00-01	3/12	GJL1213003R5101	BC6-30-10-F-2.4-51	3/35	GJL1311009R0011	B7-30-01-P-01	3/19
GJL1212101R0002	B6-40-00-02	3/12	GJL1213003R8011	BC6-30-01-F-1.4-81	3/35	GJL1311009R0012	B7-30-01-P-02	3/19
GJL1212101R0003	B6-40-00-03	3/12	GJL1213003R8101	BC6-30-10-F-1.4-81	3/35	GJL1311009R0013	B7-30-01-P-03	3/19
GJL1212101R8000	B6-40-00-80	3/12	GJL1213009R0011	BC6-30-01-P-01	3/20	GJL1311009R0101	B7-30-10-P-01	3/19
GJL1212101R8004	B6-40-00-84	3/12	GJL1213009R0013	BC6-30-01-P-03	3/20	GJL1311009R0102	B7-30-10-P-02	3/19
GJL1211501R0001	B6-22-00-01	3/12	GJL1213009R0014	BC6-30-01-P-04	3/20	GJL1311009R0103	B7-30-10-P-03	3/19
GJL1211501R0002	B6-22-00-02	3/12	GJL1213009R0015	BC6-30-01-P-05	3/20	GJL1311009R8010	B7-30-01-P-80	3/19
GJL1211501R0003	B6-22-00-03	3/12	GJL1213009R0017	BC6-30-01-P-07	3/20	GJL1311009R8014	B7-30-01-P-84	3/19
GJL1211501R8000	B6-22-00-80	3/12	GJL1213009R0101	BC6-30-10-P-01	3/20	GJL1311009R8015	B7-30-01-P-85	3/19
GJL1211501R8004	B6-22-00-84	3/12	GJL1213009R0103	BC6-30-10-P-03	3/20	GJL1311009R8100	B7-30-10-P-80	3/19
GJL1211901R0011	VB6-30-01-01	3/6	GJL1213009R0104	BC6-30-10-P-04	3/20	GJL1311009R8104	B7-30-10-P-84	3/19
GJL1211901R0012	VB6-30-01-02	3/6	GJL1213009R0105	BC6-30-10-P-05	3/20	GJL1311009R8105	B7-30-10-P-85	3/19
GJL1211901R0013	VB6-30-01-03	3/6	GJL1213009R0106	BC6-30-10-P-06	3/20	GJL1311201R0001	B7-40-00-01	3/12
GJL1211901R0101	VB6-30-10-01	3/6	GJL1213009R0107	BC6-30-10-P-07	3/20	GJL1311201R0002	B7-40-00-02	3/12
GJL1211901R0102	VB6-30-10-02	3/6	GJL1213009R1016	BC6-30-01-P-16	3/20	GJL1311201R0003	B7-40-00-03	3/12
GJL1211901R0103	VB6-30-10-03	3/6	GJL1213009R5011	BC6-30-01-P-2.4-51	3/27	GJL1311201R8000	B7-40-00-80	3/12
GJL1211901R8010	VB6-30-01-80	3/6	GJL1213009R5101	BC6-30-10-P-2.4-51	3/27	GJL1311201R8004	B7-40-00-84	3/12
GJL1211901R8014	VB6-30-01-84	3/6	GJL1213009R8011	BC6-30-01-P-1.4-81	3/27	GJL1311501R0001	B7-22-00-01	3/12
GJL1211901R8015	VB6-30-01-85	3/6	GJL1213009R8101	BC6-30-10-P-1.4-81	3/27	GJL1311501R0002	B7-22-00-02	3/12
GJL1211901R8100	VB6-30-10-80	3/6	GJL1213109R0101	BC6-21-10-P-01	3/20	GJL1311501R0003	B7-22-00-03	3/12
GJL1211901R8104	VB6-30-10-84	3/6	GJL1213109R0103	BC6-21-10-P-03	3/20	GJL1311501R8000	B7-22-00-80	3/12
GJL1211901R8105	VB6-30-10-85	3/6	GJL1213109R0104	BC6-21-10-P-04	3/20	GJL1311501R8004	B7-22-00-84	3/12
GJL1211909R0011	VB6-30-01-P-01	3/21	GJL1213109R0105	BC6-21-10-P-05	3/20	GJL1311901R0001	VB7-30-01-01	3/6
GJL1211909R0012	VB6-30-01-P-02	3/21	GJL1213109R1106	BC6-21-10-P-16	3/20	GJL1311901R0012	VB7-30-01-02	3/6
GJL1211909R0013	VB6-30-01-P-03	3/21	GJL1213501R0001	BC6-22-00-01	3/13	GJL1311901R0013	VB7-30-01-03	3/6
GJL1211909R0101	VB6-30-10-P-01	3/21	GJL1213501R0002	BC6-22-00-02	3/13	GJL1311901R0101	VB7-30-10-01	3/6
GJL1211909R0102	VB6-30-10-P-02	3/21	GJL1213501R0003	BC6-22-00-03	3/13	GJL1311901R0102	VB7-30-10-02	3/6
GJL1211909R0103	VB6-30-10-P-03	3/21	GJL1213501R0004	BC6-22-00-04	3/13	GJL1311901R0103	VB7-30-10-03	3/6
GJL1211909R8010	VB6-30-01-P-80	3/21	GJL1213501R0005	BC6-22-00-05	3/13	GJL1311901R8010	VB7-30-01-80	3/6
GJL1211909R8014	VB6-30-01-P-84	3/21	GJL1213501R0007	BC6-22-00-07	3/13	GJL1311901R8014	VB7-30-01-84	3/6
GJL1211909R8015	VB6-30-01-P-85	3/21	GJL1213501R1006	BC6-22-00-16	3/13	GJL1311901R8015	VB7-30-01-85	3/6
GJL1211909R8100	VB6-30-10-P-80	3/21	GJL1213901R0011	VBC6-30-01-01	3/7	GJL1311901R8100	VB7-30-10-80	3/6
GJL1211909R8104	VB6-30-10-P-84	3/21	GJL1213901R0013	VBC6-30-01-03	3/7	GJL1311901R8104	VB7-30-10-84	3/6
GJL1211909R8105	VB6-30-10-P-85	3/21	GJL1213901R0014	VBC6-30-01-04	3/7	GJL1311901R8105	VB7-30-10-85	3/6
GJL1211911R0011	VB6A-30-01-01	3/8	GJL1213901R0015	VBC6-30-01-05	3/7	GJL1311903R0011	VB7-30-01-F-01	3/31
GJL1211911R0012	VB6A-30-01-02	3/8	GJL1213901R0017	VBC6-30-01-07	3/7	GJL1311903R0012	VB7-30-01-F-02	3/31
GJL1211911R0013	VB6A-30-01-03	3/8	GJL1213901R0101	VBC6-30-10-01	3/7	GJL1311903R0013	VB7-30-01-F-03	3/31
GJL1211911R0101	VB6A-30-10-01	3/8	GJL1213901R0103	VBC6-30-10-03	3/7	GJL1311903R0101	VB7-30-10-F-01	3/31
GJL1211911R0102	VB6A-30-10-02	3/8	GJL1213901R0104	VBC6-30-10-04	3/7	GJL1311903R0102	VB7-30-10-F-02	3/31
GJL1211911R0103	VB6A-30-10-03	3/8	GJL1213901R0105	VBC6-30-10-05	3/7	GJL1311903R0103	VB7-30-10-F-03	3/31
GJL1211911R8010	VB6A-30-01-80	3/8	GJL1213901R0107	VBC6-30-10-07	3/7	GJL1311903R8010	VB7-30-01-F-80	3/31
GJL1211911R8014	VB6A-30-01-84	3/8	GJL1213901R1016	VBC6-30-01-16	3/7	GJL1311903R8014	VB7-30-01-F-84	3/31
GJL1211911R8015	VB6A-30-01-85	3/8	GJL1213901R1106	VBC6-30-10-16	3/7	GJL1311903R8015	VB7-30-01-F-85	3/31
GJL1211911R8100	VB6A-30-10-80	3/8	GJL1213909R0011	VBC6-30-01-P-01	3/22	GJL1311903R8100	VB7-30-10-F-80	3/31
GJL1211911R8104	VB6A-30-10-84	3/8	GJL1213909R0013	VBC6-30-01-P-03	3/22	GJL1311903R8104	VB7-30-10-F-84	3/31
GJL1211911R8105	VB6A-30-10-85	3/8	GJL1213909R0014	VBC6-30-01-P-04	3/22	GJL1311903R8105	VB7-30-10-F-85	3/31
GJL1211919R0011	VB6A-30-01-P-01	3/23	GJL1213909R0015	VBC6-30-01-P-05	3/22	GJL1311909R0011	VB7-30-01-P-01	3/21
GJL1211919R0012	VB6A-30-01-P-02	3/23	GJL1213909R0016	VBC6-30-06-P-06	3/22	GJL1311909R0012	VB7-30-01-P-02	3/21
GJL1211919R0013	VB6A-30-01-P-03	3/23	GJL1213909R0017	VBC6-30-01-P-07	3/22	GJL1311909R0013	VB7-30-01-P	

Index

Order code classification

Order code	Type	Page	Order code	Type	Page	Order code	Type	Page
GJL1311909R0103	VB7-30-10-P-03	3/21	GJL1313009R1106	BC7-30-10-P-16	3/20	GJL1313919R1106	VBC7A-30-10-P-16	3/24
GJL1311909R8010	VB7-30-01-P-80	3/21	GJL1313009R5011	BC7-30-01-P-2.4-51	3/27	GJL1317001R0011	B7D-30-01-01	3/5
GJL1311909R8014	VB7-30-01-P-84	3/21	GJL1313009R5101	BC7-30-10-P-2.4-51	3/27	GJL1317001R0015	B7D-30-01-05	3/5
GJL1311909R8015	VB7-30-01-P-85	3/21	GJL1313009R8011	BC7-30-01-P-1.4-81	3/27	GJL1317001R0101	B7D-30-10-01	3/5
GJL1311909R8100	VB7-30-10-P-80	3/21	GJL1313009R8101	BC7-30-10-P-1.4-81	3/27	GJL1317001R0105	B7D-30-10-05	3/5
GJL1311909R8104	VB7-30-10-P-84	3/21	GJL1313061R5011	TBC7-30-01-51	3/11	GJL1317201R0001	B7D-40-00-01	3/13
GJL1311909R8105	VB7-30-10-P-85	3/21	GJL1313061R5015	TBC7-30-01-55	3/11	GJL1317201R0005	B7D-40-00-05	3/13
GJL1311911R0011	VB7A-30-01-01	3/8	GJL1313061R5101	TBC7-30-10-51	3/11	SK178001-LB	LT550-EK	5/404
GJL1311911R0012	VB7A-30-01-02	3/8	GJL1313061R5105	TBC7-30-10-55	3/11	SK178001-MB	LT1000-EK	5/404
GJL1311911R0013	VB7A-30-01-03	3/8	GJL1313061R6012	TBC7-30-01-62	3/11	SK827041-AD	EK550-40-11	5/208
GJL1311911R0101	VB7A-30-10-01	3/8	GJL1313061R6018	TBC7-30-01-68	3/11	SK827041-AR	EK550-40-11	5/208
GJL1311911R0102	VB7A-30-10-02	3/8	GJL1313061R6102	TBC7-30-10-62	3/11	SK827041-DB	EK550-40-21	5/209
GJL1311911R0103	VB7A-30-10-03	3/8	GJL1313061R6108	TBC7-30-10-68	3/11	SK827041-DC	EK550-40-21	5/209
GJL1311911R8010	VB7A-30-01-80	3/8	GJL1313461R5005	TBC7-31-00-55	3/14	SK827041-DD	EK550-40-21	5/209
GJL1311911R8014	VB7A-30-01-84	3/8	GJL1313461R6002	TBC7-31-00-62	3/14	SK827041-DE	EK550-40-21	5/209
GJL1311911R8015	VB7A-30-01-85	3/8	GJL1313461R6008	TBC7-31-00-68	3/14	SK827041-DF	EK550-40-21	5/209
GJL1311911R8100	VB7A-30-10-80	3/8	GJL1313561R5005	TBC7-22-00-55	3/14	SK827041-DG	EK550-40-21	5/209
GJL1311911R8104	VB7A-30-10-84	3/8	GJL1313561R6002	TBC7-22-00-62	3/14	SK827041-DT	EK550-40-21	5/209
GJL1311911R8105	VB7A-30-10-85	3/8	GJL1313561R6008	TBC7-22-00-68	3/14	SK827041-DU	EK550-40-21	5/209
GJL1311913R0011	VB7A-30-01-F-01	3/33	GJL1313901R0011	VBC7-30-01-01	3/7	SK827041-EF	EK550-40-11	5/208
GJL1311913R0012	VB7A-30-01-F-02	3/33	GJL1313901R0013	VBC7-30-01-03	3/7	SK827041-EG	EK550-40-11	5/208
GJL1311913R0013	VB7A-30-01-F-03	3/33	GJL1313901R0014	VBC7-30-01-04	3/7	SK827041-EL	EK550-40-11	5/208
GJL1311913R0101	VB7A-30-10-F-01	3/33	GJL1313901R0015	VBC7-30-01-05	3/7	SK827041-EM	EK550-40-11	5/208
GJL1311913R0102	VB7A-30-10-F-02	3/33	GJL1313901R0017	VBC7-30-01-07	3/7	SK827041-EP	EK550-40-11	5/208
GJL1311913R0103	VB7A-30-10-F-03	3/33	GJL1313901R0101	VBC7-30-10-01	3/7	SK827041-ER	EK550-40-11	5/208
GJL1311913R8010	VB7A-30-01-F-80	3/33	GJL1313901R0103	VBC7-30-10-03	3/7	SK827043-AD	EK550-40-22	5/210
GJL1311913R8014	VB7A-30-01-F-84	3/33	GJL1313901R0104	VBC7-30-10-04	3/7	SK827043-AR	EK550-40-22	5/210
GJL1311913R8015	VB7A-30-01-F-85	3/33	GJL1313901R0105	VBC7-30-10-05	3/7	SK827043-EF	EK550-40-22	5/210
GJL1311913R8100	VB7A-30-10-F-80	3/33	GJL1313901R0107	VBC7-30-10-07	3/7	SK827043-EG	EK550-40-22	5/210
GJL1311913R8104	VB7A-30-10-F-84	3/33	GJL1313901R1016	VBC7-30-01-16	3/7	SK827043-EL	EK550-40-22	5/210
GJL1311913R8105	VB7A-30-10-F-85	3/33	GJL1313901R1106	VBC7-30-10-16	3/7	SK827043-EM	EK550-40-22	5/210
GJL1311919R0011	VB7A-30-01-P-01	3/23	GJL1313903R0011	VBC7-30-01-F-01	3/32	SK827043-EP	EK550-40-22	5/210
GJL1311919R0012	VB7A-30-01-P-02	3/23	GJL1313903R0013	VBC7-30-01-F-03	3/32	SK827043-ER	EK550-40-22	5/210
GJL1311919R0013	VB7A-30-01-P-03	3/23	GJL1313903R0014	VBC7-30-01-F-04	3/32	SK827044-AD	EK1000-40-11	5/208
GJL1311919R0101	VB7A-30-10-P-01	3/23	GJL1313903R0015	VBC7-30-01-F-05	3/32	SK827044-AR	EK1000-40-11	5/208
GJL1311919R0102	VB7A-30-10-P-02	3/23	GJL1313903R0017	VBC7-30-01-F-07	3/32	SK827044-DB	EK1000-40-21	5/209
GJL1311919R0103	VB7A-30-10-P-03	3/23	GJL1313903R0101	VBC7-30-10-F-01	3/32	SK827044-DC	EK1000-40-21	5/209
GJL1311919R8010	VB7A-30-01-P-80	3/23	GJL1313903R0103	VBC7-30-10-F-03	3/32	SK827044-DD	EK1000-40-21	5/209
GJL1311919R8014	VB7A-30-01-P-84	3/23	GJL1313903R0104	VBC7-30-10-F-04	3/32	SK827044-DE	EK1000-40-21	5/209
GJL1311919R8015	VB7A-30-01-P-85	3/23	GJL1313903R0105	VBC7-30-10-F-05	3/32	SK827044-DF	EK1000-40-21	5/209
GJL1311919R8100	VB7A-30-10-P-80	3/23	GJL1313903R0107	VBC7-30-10-F-07	3/32	SK827044-DG	EK1000-40-21	5/209
GJL1311919R8104	VB7A-30-10-P-84	3/23	GJL1313903R1016	VBC7-30-01-F-16	3/32	SK827044-DT	EK1000-40-21	5/209
GJL1311919R8105	VB7A-30-10-P-85	3/23	GJL1313903R1106	VBC7-30-01-F-16	3/32	SK827044-DU	EK1000-40-21	5/209
GJL1313001R0011	BC7-30-01-01	3/5	GJL1313909R0011	VBC7-30-01-P-01	3/22	SK827044-EF	EK1000-40-11	5/208
GJL1313001R0013	BC7-30-01-03	3/5	GJL1313909R0013	VBC7-30-01-P-03	3/22	SK827044-EG	EK1000-40-11	5/208
GJL1313001R0014	BC7-30-01-04	3/5	GJL1313909R0014	VBC7-30-01-P-04	3/22	SK827044-EL	EK1000-40-11	5/208
GJL1313001R0015	BC7-30-01-05	3/5	GJL1313909R0015	VBC7-30-01-P-05	3/22	SK827044-EM	EK1000-40-11	5/208
GJL1313001R0017	BC7-30-01-07	3/5	GJL1313909R0017	VBC7-30-01-P-07	3/22	SK827044-EP	EK1000-40-11	5/208
GJL1313001R0101	BC7-30-10-01	3/5	GJL1313909R0101	VBC7-30-10-P-01	3/22	SK827044-ER	EK1000-40-11	5/208
GJL1313001R0104	BC7-30-10-04	3/5	GJL1313909R0103	VBC7-30-10-P-03	3/22	SK827045-AD	EK1000-40-22	5/210
GJL1313001R0105	BC7-30-10-05	3/5	GJL1313909R0104	VBC7-30-10-P-04	3/22	SK827045-AR	EK1000-40-22	5/210
GJL1313001R0107	BC7-30-10-07	3/5	GJL1313909R0105	VBC7-30-10-P-05	3/22	SK827045-EF	EK1000-40-22	5/210
GJL1313001R1016	BC7-30-01-16	3/5	GJL1313909R0107	VBC7-30-10-P-07	3/22	SK827045-EG	EK1000-40-22	5/210
GJL1313001R1103	BC7-30-10-03	3/5	GJL1313909R1016	VBC7-30-01-P-16	3/22	SK827045-EL	EK1000-40-22	5/210
GJL1313001R1106	BC7-30-10-16	3/5	GJL1313909R1106	VBC7-30-10-P-16	3/22	SK827045-EM	EK1000-40-22	5/210
GJL1313001R5011	BC7-30-01-2.4-51	3/10	GJL1313911R0011	VBC7A-30-01-01	3/9	SK827045-EP	EK1000-40-22	5/210
GJL1313001R5101	BC7-30-10-2.4-51	3/10	GJL1313911R0013	VBC7A-30-01-03	3/9	SK827045-ER	EK1000-40-22	5/210
GJL1313001R7011	B7S-30-01-1.7-71	3/10	GJL1313911R0014	VBC7A-30-01-04	3/9	SK827204-B	KZK550	5/408
GJL1313001R7012	B7S-30-01-2.8-72	3/10	GJL1313911R0015	VBC7A-30-01-05	3/9	SK827204-F	KZK1000	5/408
GJL1313001R7101	B7S-30-10-1.7-71	3/10	GJL1313911R0016	VBC7A-30-01-16	3/9	SK828100-AD	KH800	5/409
GJL1313001R7102	B7S-30-10-2.8-72	3/10	GJL1313911R0017	VBC7A-30-01-07	3/9	SK828100-AR	KH800	5/409
GJL1313001R8011	BC7-30-01-1.4-81	3/10	GJL1313911R0101	VBC7A-30-10-01	3/9	SK828100-EF	KH800	5/409
GJL1313001R8101	BC7-30-10-1.4-81	3/10	GJL1313911R0103	VBC7A-30-10-03	3/9	SK828100-EG	KH800	5/409
GJL1313003R0011	BC7-30-01-F-01	3/30	GJL1313911R0104	VBC7A-30-10-04	3/9	SK828100-EL	KH800	5/409
GJL1313003R0013	BC7-30-01-F-03	3/30	GJL1313911R0105	VBC7A-30-10-05	3/9	SK828100-EM	KH800	5/409
GJL1313003R0014	BC7-30-01-F-04	3/30	GJL1313911R0107	VBC7A-30-10-07	3/9	SK828100-EP	KH800	5/409
GJL1313003R0015	BC7-30-01-F-05	3/30	GJL1313911R1106	VBC7A-30-10-16	3/9	SK828100-ER	KH800	5/409
GJL1313003R0017	BC7-30-01-F-07	3/30	GJL1313913R0011	VBC7A-30-01-F-01	3/34	SK828150-DB	KP800	5/409
GJL1313003R0101	BC7-30-10-F-01	3/30	GJL1313913R0013	VBC7A-30-01-F-03	3/34	SK828150-DC	KP800	5/409
GJL1313003R0103	BC7-30-10-F-03	3/30	GJL1313913R0014	VBC7A-30-01-F-04	3/34	SK828150-DD	KP800	5/409
GJL1313003R0104	BC7-30-10-F-04	3/30	GJL1313913R0015	VBC7A-30-01-F-05	3/34	SK828150-DE	KP800	5/409
GJL1313003R0105	BC7-30-10-F-05	3/30	GJL1313913R0017	VBC7A-30-01-F-07	3/34	SK828150-DF	KP800	5/409
GJL1313003R0107	BC7-30-10-F-07	3/30	GJL1313913R0101	VBC7A-30-10-F-01	3/34	SK828150-DG	KP800	5/409
GJL1313003R1016	BC7-30-01-F-16	3/30	GJL1313913R0103	VBC7A-30-10-F-03	3/34	SK828150-DT	KP800	5/409
GJL1313003R1106	BC7-30-10-F-16	3/30	GJL1313913R0104	VBC7A-30-10-F-04	3/34	SK828150-DU	KP800	5/409
GJL1313003R5011	BC7-30-01-F-2.4-51	3/35	GJL1313913R0105	VBC7A-30-10-F-05	3/34	SK829002-A	CAL16-11A	5/400
GJL1313003R5101	BC7-30-10-F-2.4-51	3/35	GJL1313913R0107	VBC7A-30-10-F-07	3/35	SK829002-B	CAL16-11B	5/213
GJL1313003R8011	BC7-30-01-F-1.4-81	3/35	GJL1313913R1016	VBC7A-30-01-F-16	3/34	SK829002-C	CAL16-11C	5/213
GJL1313003R8101	BC7-30-10-F-1.4-81	3/35	GJL1313913R1106	VBC7A-30-10-F-16	3/34	SK829002-D	CAL16-11D	5/213
GJL1313009R0011	BC7-30-01-P-01	3/20	GJL1313919R0011	VBC7A-30-01-P-01	3/24	SK829002-E	CCL16-11E	5/213
GJL1313009R0013	BC7-30-01-P-03	3/20	GJL1313919R0013	VBC7A-30-01-P-03	3/24	SK829007-C	RC-EH800/110	5/213
GJL1313009R0014	BC7-30-01-P-04	3/20	GJL1313919R0014	VBC7A-30-01-P-04	3/24	SK829007-D	RC-EH800/600	5/213
GJL1313009R0015	BC7-30-01-P-05	3/20	GJL1313919R0015	VBC7A-30-01-P-05	3/24	SK829070-F	VH800	5/213
GJL1313009R0017	BC7-30-01-P-07	3/20	GJL1313919R0017	VBC7A-30-01-P-07	3/24	SK829090-E	BSS550	5/213
GJL1313009R0101	BC7-30-10-P-01	3/20	GJL1313919R0101	VBC7A-30-10-P-01	3/24	SK829090-H	BSS1000	5/213
GJL1313009R0103	BC7-30-10-P-03	3/20	GJL1313919R0103	VBC7A-30-10-P-03	3/24			
GJL1313009R0104	BC7-30-10-P-04	3/20	GJL1313919R0104	VBC7A-30-10-P-04	3/24			
GJL1313009R0105	BC7-30-10-P-05	3/20	GJL1313919R0105	VBC7A-30-10-P-05	3/24			
GJL1313009R0107	BC7-30-10-P-07	3/20	GJL1313919R0107	VBC7A-30-10-P-07	3/24			
GJL1313009R1016	BC7-30-01-P-16	3/20	GJL1313919R1016	VBC7A-30-01-P-16	3/24			

Index

Type classification

Type	Order code	Page	Type	Order code	Page	Type	Order code	Page
AA1-110	1SAM201910R1002	2/24	AF116-30-11-34	1SFL427001R3411	5/97	AF12Z-30-10S-23	1SBL156004R2310	6/47
AA1-230	1SAM201910R1003	2/24	AF116-30-11B-11	1SFL427002R1111	5/96	AF12Z-30-22-20	1SBL156001R2022	5/109
AA1-24	1SAM201910R1001	2/24	AF116-30-11B-12	1SFL427002R1211	5/96	AF12Z-30-22-21	1SBL156001R2122	5/109
AA1-400	1SAM201910R1004	2/24	AF116-30-11B-13	1SFL427002R1311	5/96	AF12Z-30-22-22	1SBL156001R2222	5/109
AA4-110	1SAM401907R1002	2/44	AF116-30-11B-14	1SFL427002R1411	5/96	AF12Z-30-22-23	1SBL156001R2322	5/109
AA4-230	1SAM401907R1003	2/44	AF116-30-11B-33	1SFL427002R3311	5/97	AF12Z-30-22S-20	1SBL156004R2022	6/49
AA4-24	1SAM401907R1001	2/44	AF116-30-11B-34	1SFL427002R3411	5/97	AF12Z-30-22S-21	1SBL156004R2122	6/49
AA4-400	1SAM401907R1004	2/44	AF116-30-22-11	1SFL427001R1122	5/114	AF12Z-30-22S-22	1SBL156004R2222	6/49
AF09-22-00-12	1SBL137501R1200	5/190	AF116-30-22-12	1SFL427001R1222	5/114	AF12Z-30-22S-23	1SBL156004R2322	6/49
AF09-22-00-13	1SBL137501R1300	5/190	AF116-30-22-13	1SFL427001R1322	5/114	AF1350-30-11	1SFL657001R7011	5/103
AF09-22-00-14	1SBL137501R1400	5/190	AF116-30-22-14	1SFL427001R1422	5/114	AF1350-30-22	1SFL657001R7022	5/121
AF09-22-00-41	1SBL137501R4100	5/190	AF116-30-22-33	1SFL427001R3322	5/115	AF1350-30T-11	1SFL657001R9101	5/105
AF09-30-01-12	1SBL137001R1201	5/84	AF116-30-22-34	1SFL427001R3422	5/115	AF140-30-00-11	1SFL447001R1100	5/90
AF09-30-01-13	1SBL137001R1301	5/84	AF116-30-22B-11	1SFL427002R1122	5/114	AF140-30-00-12	1SFL447001R1200	5/90
AF09-30-01-14	1SBL137001R1401	5/84	AF116-30-22B-12	1SFL427002R1222	5/114	AF140-30-00-13	1SFL447001R1300	5/90
AF09-30-01-41	1SBL137001R4101	5/84	AF116-30-22B-13	1SFL427002R1322	5/114	AF140-30-00-14	1SFL447001R1400	5/90
AF09-30-01S-12	1SBL137004R1201	6/46	AF116-30-22B-14	1SFL427002R1422	5/114	AF140-30-00-33	1SFL447001R3300	5/91
AF09-30-01S-13	1SBL137004R1301	6/46	AF116-30-22B-33	1SFL427002R3322	5/115	AF140-30-00-34	1SFL447001R3400	5/91
AF09-30-01S-14	1SBL137004R1401	6/46	AF116-30-22B-34	1SFL427002R3422	5/115	AF140-30-00B-11	1SFL447002R1100	5/90
AF09-30-01S-41	1SBL137004R4101	6/46	AF116-40-00-11	1SFL427101R1100	5/196	AF140-30-00B-12	1SFL447002R1200	5/90
AF09-30-10-12	1SBL137001R1210	5/84	AF116-40-00-12	1SFL427101R1200	5/196	AF140-30-00B-13	1SFL447002R1300	5/90
AF09-30-10-13	1SBL137001R1310	5/84	AF116-40-00-13	1SFL427101R1300	5/196	AF140-30-00B-14	1SFL447002R1400	5/90
AF09-30-10-14	1SBL137001R1410	5/84	AF116-40-00-14	1SFL427101R1400	5/196	AF140-30-00B-33	1SFL447002R3300	5/91
AF09-30-10-41	1SBL137001R4110	5/84	AF116-40-00B-11	1SFL427102R1100	5/196	AF140-30-00B-34	1SFL447002R3400	5/91
AF09-30-10S-12	1SBL137004R1210	6/46	AF116-40-00B-12	1SFL427102R1200	5/196	AF140-30-11-11	1SFL447001R1111	5/20
AF09-30-10S-13	1SBL137004R1310	6/46	AF116-40-00B-13	1SFL427102R1300	5/196	AF140-30-11-12	1SFL447001R1211	5/96
AF09-30-10S-14	1SBL137004R1410	6/46	AF116-40-00B-14	1SFL427102R1400	5/196	AF140-30-11-13	1SFL447001R1311	5/20
AF09-30-10S-41	1SBL137004R4110	6/46	AF116-40-11-11	1SFL427101R1111	5/200	AF140-30-11-14	1SFL447001R1411	5/96
AF09-30-22-12	1SBL137001R1222	5/108	AF116-40-11-12	1SFL427101R1211	5/200	AF140-30-11-33	1SFL447001R3311	5/97
AF09-30-22-13	1SBL137001R1322	5/108	AF116-40-11-13	1SFL427101R1311	5/200	AF140-30-11-34	1SFL447001R3411	5/97
AF09-30-22-14	1SBL137001R1422	5/108	AF116-40-11-14	1SFL427101R1411	5/200	AF140-30-11B-11	1SFL447002R1111	5/96
AF09-30-22-41	1SBL137001R4122	5/108	AF116-40-11B-11	1SFL427102R1111	5/200	AF140-30-11B-12	1SFL447002R1211	5/96
AF09-30-22S-12	1SBL137004R1222	6/48	AF116-40-11B-12	1SFL427102R1211	5/200	AF140-30-11B-13	1SFL447002R1311	5/96
AF09-30-22S-13	1SBL137004R1322	6/48	AF116-40-11B-13	1SFL427102R1311	5/200	AF140-30-11B-14	1SFL447002R1411	5/96
AF09-30-22S-14	1SBL137004R1422	6/48	AF116-40-11B-14	1SFL427102R1411	5/200	AF140-30-11B-33	1SFL447002R3311	5/97
AF09-30-22S-41	1SBL137004R4122	6/48	AF116-40-22-11	1SFL427101R1122	5/204	AF140-30-11B-34	1SFL447002R3411	5/97
AF09-40-00-12	1SBL137201R1200	5/190	AF116-40-22-12	1SFL427101R1222	5/204	AF140-30-22-11	1SFL447001R1122	5/114
AF09-40-00-13	1SBL137201R1300	5/190	AF116-40-22-13	1SFL427101R1322	5/204	AF140-30-22-12	1SFL447001R1222	5/114
AF09-40-00-14	1SBL137201R1400	5/190	AF116-40-22-14	1SFL427101R1422	5/204	AF140-30-22-13	1SFL447001R1322	5/114
AF09-40-00-41	1SBL137201R4100	5/190	AF116-40-22B-11	1SFL427102R1122	5/204	AF140-30-22-33	1SFL447001R3322	5/115
AF09Z-22-00-20	1SBL136501R2000	5/191	AF116-40-22B-12	1SFL427102R1222	5/204	AF140-30-22-34	1SFL447001R3422	5/115
AF09Z-22-00-21	1SBL136501R2100	5/191	AF116-40-22B-13	1SFL427102R1322	5/204	AF140-30-22B-11	1SFL447002R1122	5/114
AF09Z-22-00-22	1SBL136501R2200	5/191	AF116-40-22B-14	1SFL427102R1422	5/204	AF140-30-22B-12	1SFL447002R1222	5/114
AF09Z-22-00-23	1SBL136501R2300	5/191	AF12-30-01-12	1SBL157001R1201	5/84	AF140-30-22B-13	1SFL447002R1322	5/114
AF09Z-30-01-20	1SBL136001R2001	5/85	AF12-30-01-13	1SBL157001R1301	5/84	AF140-30-22B-14	1SFL447002R1422	5/114
AF09Z-30-01-21	1SBL136001R2101	5/85	AF12-30-01-14	1SBL157001R1401	5/84	AF140-30-22B-33	1SFL447002R3322	5/115
AF09Z-30-01-22	1SBL136001R2201	5/85	AF12-30-01S-12	1SBL157004R1201	6/46	AF140-30-22B-34	1SFL447002R3422	5/115
AF09Z-30-01-23	1SBL136001R2301	5/85	AF12-30-01S-13	1SBL157004R1301	6/46	AF140-40-00-11	1SFL447101R1100	5/196
AF09Z-30-01S-20	1SBL136004R2001	6/47	AF12-30-01S-14	1SBL157004R1401	6/46	AF140-40-00-12	1SFL447101R1200	5/196
AF09Z-30-01S-21	1SBL136004R2101	6/47	AF12-30-01S-41	1SBL157004R4101	6/46	AF140-40-00-13	1SFL447101R1300	5/196
AF09Z-30-01S-22	1SBL136004R2201	6/47	AF12-30-10-12	1SBL157001R1210	5/84	AF140-40-00-14	1SFL447101R1400	5/196
AF09Z-30-01S-23	1SBL136004R2301	6/47	AF12-30-10-13	1SBL157001R1310	5/6	AF140-40-00B-11	1SFL447102R1100	5/196
AF09Z-30-10-20	1SBL136001R2010	5/85	AF12-30-10-14	1SBL157001R1410	5/84	AF140-40-00B-12	1SFL447102R1200	5/196
AF09Z-30-10-21	1SBL136001R2110	5/6	AF12-30-10-41	1SBL157001R4110	5/84	AF140-40-00B-13	1SFL447102R1300	5/196
AF09Z-30-10-22	1SBL136001R2210	5/85	AF12-30-10S-12	1SBL157004R1210	6/46	AF140-40-00B-14	1SFL447102R1400	5/196
AF09Z-30-10-23	1SBL136001R2310	5/85	AF12-30-10S-13	1SBL157004R1310	6/46	AF140-40-11-11	1SFL447101R1111	5/200
AF09Z-30-10S-20	1SBL136004R2010	6/47	AF12-30-10S-14	1SBL157004R1410	6/46	AF140-40-11-12	1SFL447101R1211	5/200
AF09Z-30-10S-21	1SBL136004R2110	6/47	AF12-30-10S-41	1SBL157004R4110	6/46	AF140-40-11-13	1SFL447101R1311	5/200
AF09Z-30-10S-22	1SBL136004R2210	6/47	AF12-30-22-12	1SBL157001R1222	5/108	AF140-40-11-14	1SFL447101R1411	5/200
AF09Z-30-10S-23	1SBL136004R2310	6/47	AF12-30-22-13	1SBL157001R1322	5/108	AF140-40-11B-11	1SFL447102R1111	5/200
AF09Z-30-22-20	1SBL136001R2022	5/109	AF12-30-22-14	1SBL157001R1422	5/108	AF140-40-11B-12	1SFL447102R1211	5/200
AF09Z-30-22-21	1SBL136001R2122	5/109	AF12-30-22-41	1SBL157001R4122	5/108	AF140-40-11B-13	1SFL447102R1311	5/200
AF09Z-30-22-22	1SBL136001R2222	5/109	AF12-30-22S-12	1SBL157004R1222	6/48	AF140-40-11B-14	1SFL447102R1411	5/200
AF09Z-30-22-23	1SBL136001R2322	5/109	AF12-30-22S-13	1SBL157004R1322	6/48	AF140-40-22-11	1SFL447101R1122	5/204
AF09Z-30-22S-20	1SBL136004R2022	6/49	AF12-30-22S-14	1SBL157004R1422	6/48	AF140-40-22-12	1SFL447101R1222	5/204
AF09Z-30-22S-21	1SBL136004R2122	6/49	AF12-30-22S-41	1SBL157004R4122	6/48	AF140-40-22-13	1SFL447101R1322	5/204
AF09Z-30-22S-22	1SBL136004R2222	6/49	AF1250-30-11	1SFL647001R6811	5/103	AF140-40-22-14	1SFL447101R1422	5/204
AF09Z-30-22S-23	1SBL136004R2322	6/49	AF1250-30-22	1SFL647001R6822	5/121	AF140-40-22B-11	1SFL447102R1122	5/204
AF09Z-40-00-20	1SBL136201R2000	5/191	1SFL647001R6922	5/121	AF140-40-22B-12	1SFL447102R1222	5/204
AF09Z-40-00-21	1SBL136201R2100	5/191	1SFL647001R7022	5/121	AF140-40-22B-13	1SFL447102R1322	5/204
AF09Z-40-00-22	1SBL136201R2200	5/191	1SFL647001R7122	5/121	AF140-40-22B-14	1SFL447102R1422	5/204
AF09Z-40-00-23	1SBL136201R2300	5/191	AF12Z-30-01-20	1SBL156001R2001	5/85	AF146-30-00-11	1SFL467001R1100	5/90
AF116-30-00-11	1SFL427001R1100	5/90	AF12Z-30-01-21	1SBL156001R2101	5/85	AF146-30-00-12	1SFL467001R1200	5/90
AF116-30-00-12	1SFL427001R1200	5/90	AF12Z-30-01-22	1SBL156001R2201	5/85	AF146-30-00-13	1SFL467001R1300	5/90
AF116-30-00-13	1SFL427001R1300	5/90	AF12Z-30-01-23	1SBL156001R2301	5/85	AF146-30-00-14	1SFL467001R1400	5/90
AF116-30-00-14	1SFL427001R1400	5/90	AF12Z-30-01S-20	1SBL156004R2001	6/47	AF146-30-00-33	1SFL467001R3300	5/91
AF116-30-00-33	1SFL427001R3300	5/91	AF12Z-30-01S-21	1SBL156004R2101	6/47	AF146-30-00-34	1SFL467001R3400	5/91
AF116-30-00-34	1SFL427001R3400	5/91	AF12Z-30-01S-22	1SBL156004R2201	6/47	AF146-30-00B-11	1SFL467002R1100	5/90
AF116-30-00B-11	1SFL427002R1100	5/90	AF12Z-30-01S-23	1SBL156004R2301	6/47	AF146-30-00B-12	1SFL467002R1200	5/90
AF116-30-00B-12	1SFL427002R1200	5/90	AF12Z-30-10-20	1SBL156001R2010	5/85	AF146-30-00B-13	1SFL467002R1300	5/90
AF116-30-00B-13	1SFL427002R1300	5/90	AF12Z-30-10-21	1SBL156001R2101	5/6	AF146-30-00B-14	1SFL467002R1400	5/90
AF116-30-00B-14	1SFL427002R1400	5/90	AF12Z-30-10-22	1SBL156001R2210	5/85	AF146-30-00B-33	1SFL467002R3300	5/91
AF116-30-00B-33	1SFL427002R3300	5/91	AF12Z-30-10-23	1SBL156001R2310	5/85	AF146-30-00B-34	1SFL467002R3400	5/91
AF116-30-00B-34	1SFL427002R3400	5/91	AF12Z-30-10S-20	1SBL156004R2010	6/47	AF146-30-11-11	1SFL467001R1111	5/96
AF116-30-11-11	1SFL427001R1111	5/20	AF12Z-30-10S-21	1SBL156004R2110	6/47	AF146-30-11-12	1SFL467001	

Index

Type classification

Type	Order code	Page	Type	Order code	Page	Type	Order code	Page
AF146-30-11B-11	1SFL467002R1111	5/96	AF190-30-00-34	1SFL487002R3400	5/93	AF2650-30-11	1SFL667001R7011	5/103
AF146-30-11B-12	1SFL467002R1211	5/96	AF190-30-11-11	1SFL487002R1111	5/20	AF2650-30-22	1SFL667001R7022	5/121
AF146-30-11B-13	1SFL467002R1311	5/96	AF190-30-11-12	1SFL487002R1211	5/98	AF2650-30T-11	1SFL667001R9101	5/105
AF146-30-11B-14	1SFL467002R1411	5/96	AF190-30-11-13	1SFL487002R1311	5/20	AF265-30-00-11	1SFL547002R1100	5/92
AF146-30-11B-33	1SFL467002R3311	5/97	AF190-30-11-14	1SFL487002R1411	5/98	AF265-30-00-12	1SFL547002R1200	5/92
AF146-30-11B-34	1SFL467002R3411	5/97	AF190-30-11-33	1SFL487002R3311	5/99	AF265-30-00-13	1SFL547002R1300	5/92
AF146-30-22-11	1SFL467001R1122	5/114	AF190-30-11-34	1SFL487002R3411	5/99	AF265-30-00-14	1SFL547002R1400	5/92
AF146-30-22-12	1SFL467001R1222	5/114	AF190-30-22-11	1SFL487002R1122	5/116	AF265-30-00-33	1SFL547002R3300	5/93
AF146-30-22-13	1SFL467001R1322	5/114	AF190-30-22-12	1SFL487002R1222	5/116	AF265-30-00-34	1SFL547002R3400	5/93
AF146-30-22-14	1SFL467001R1422	5/114	AF190-30-22-13	1SFL487002R1322	5/116	AF265-30-11-11	1SFL547002R1111	5/20
AF146-30-22-33	1SFL467001R3322	5/115	AF190-30-22-14	1SFL487002R1422	5/116	AF265-30-11-12	1SFL547002R1211	5/98
AF146-30-22-34	1SFL467001R3422	5/115	AF190-30-22-33	1SFL487002R3322	5/117	AF265-30-11-13	1SFL547002R1311	5/20
AF146-30-22B-11	1SFL467002R1122	5/114	AF190-30-22-34	1SFL487002R3422	5/117	AF265-30-11-14	1SFL547002R1411	5/98
AF146-30-22B-12	1SFL467002R1222	5/114	AF190-40-00-11	1SFL487102R1100	5/197	AF265-30-11-33	1SFL547002R3311	5/99
AF146-30-22B-13	1SFL467002R1322	5/114	AF190-40-00-12	1SFL487102R1200	5/197	AF265-30-11-34	1SFL547002R3411	5/99
AF146-30-22B-14	1SFL467002R1422	5/114	AF190-40-00-13	1SFL487102R1300	5/197	AF265-30-22-11	1SFL547002R1122	5/116
AF146-30-22B-33	1SFL467002R3322	5/115	AF190-40-00-14	1SFL487102R1400	5/197	AF265-30-22-12	1SFL547002R1222	5/116
AF146-30-22B-34	1SFL467002R3422	5/115	AF190-40-11-11	1SFL487102R1111	5/201	AF265-30-22-13	1SFL547002R1322	5/116
AF16-22-00-12	1SBL177501R1200	5/190	AF190-40-11-12	1SFL487102R1211	5/201	AF265-30-22-14	1SFL547002R1422	5/116
AF16-22-00-13	1SBL177501R1300	5/190	AF190-40-11-13	1SFL487102R1311	5/201	AF265-30-22-33	1SFL547002R3322	5/117
AF16-22-00-14	1SBL177501R1400	5/190	AF190-40-11-14	1SFL487102R1411	5/201	AF265-30-22-34	1SFL547002R3422	5/117
AF16-22-00-41	1SBL177501R4100	5/190	AF190-40-22-11	1SFL487102R1122	5/205	AF265-40-00-11	1SFL547102R1100	5/197
AF16-30-01-12	1SBL177001R1201	5/84	AF190-40-22-12	1SFL487102R1222	5/205	AF265-40-00-12	1SFL547102R1200	5/197
AF16-30-01-13	1SBL177001R1301	5/84	AF190-40-22-13	1SFL487102R1322	5/205	AF265-40-00-13	1SFL547102R1300	5/197
AF16-30-01-14	1SBL177001R1401	5/84	AF190-40-22-14	1SFL487102R1422	5/205	AF265-40-00-14	1SFL547102R1400	5/197
AF16-30-01-41	1SBL177001R4101	5/84	AF2050-30-11	1SFL707001R7011	5/103	AF265-40-11-11	1SFL547102R1111	5/201
AF16-30-01S-12	1SBL177004R1201	6/46	AF2050-30-22	1SFL707001R7022	5/121	AF265-40-11-12	1SFL547102R1211	5/201
AF16-30-01S-13	1SBL177004R1301	6/46	AF2050-30T-11	1SFL707001R9101	5/105	AF265-40-11-13	1SFL547102R1311	5/201
AF16-30-01S-14	1SBL177004R1401	6/46	AF205-30-00-11	1SFL527002R1100	5/92	AF265-40-11-14	1SFL547102R1411	5/201
AF16-30-01S-41	1SBL177004R4101	6/46	AF205-30-00-12	1SFL527002R1200	5/92	AF265-40-22-11	1SFL547102R1122	5/205
AF16-30-10-12	1SBL177001R1210	5/84	AF205-30-00-13	1SFL527002R1300	5/92	AF265-40-22-12	1SFL547102R1222	5/205
AF16-30-10-13	1SBL177001R1310	5/6	AF205-30-00-14	1SFL527002R1400	5/92	AF265-40-22-13	1SFL547102R1322	5/205
AF16-30-10-14	1SBL177001R1410	5/84	AF205-30-00-33	1SFL527002R3300	5/93	AF265-40-22-14	1SFL547102R1422	5/205
AF16-30-10-41	1SBL177001R4110	5/84	AF205-30-00-34	1SFL527002R3400	5/93	AF26Z-22-00-20	1SBL236501R2000	5/191
AF16-30-10S-12	1SBL177004R1210	6/46	AF205-30-11-11	1SFL527002R1111	5/20	AF26Z-22-00-21	1SBL236501R2100	5/191
AF16-30-10S-13	1SBL177004R1310	6/46	AF205-30-11-12	1SFL527002R1211	5/98	AF26Z-22-00-22	1SBL236501R2200	5/191
AF16-30-10S-14	1SBL177004R1410	6/46	AF205-30-11-13	1SFL527002R1311	5/20	AF26Z-22-00-23	1SBL236501R2300	5/191
AF16-30-10S-41	1SBL177004R4110	6/46	AF205-30-11-14	1SFL527002R1411	5/98	AF26Z-30-00-20	1SBL236601R2000	5/85
AF16-30-22-12	1SBL177001R1222	5/108	AF205-30-11-33	1SFL527002R3311	5/99	AF26Z-30-00-21	1SBL236601R2100	5/6
AF16-30-22-13	1SBL177001R1322	5/108	AF205-30-11-34	1SFL527002R3411	5/99	AF26Z-30-00-22	1SBL236601R2200	5/85
AF16-30-22-14	1SBL177001R1422	5/108	AF205-30-22-11	1SFL527002R1122	5/116	AF26Z-30-00-23	1SBL236601R2300	5/85
AF16-30-22-41	1SBL177001R4122	5/108	AF205-30-22-12	1SFL527002R1222	5/116	AF26Z-30-00S-20	1SBL236604R2000	6/47
AF16-30-22S-12	1SBL177004R1222	6/48	AF205-30-22-13	1SFL527002R1322	5/116	AF26Z-30-00S-21	1SBL236604R2100	6/47
AF16-30-22S-13	1SBL177004R1322	6/48	AF205-30-22-14	1SFL527002R1422	5/116	AF26Z-30-00S-22	1SBL236604R2200	6/47
AF16-30-22S-14	1SBL177004R1422	6/48	AF205-30-22-33	1SFL527002R3322	5/117	AF26Z-30-00S-23	1SBL236604R2300	6/47
AF16-30-22S-41	1SBL177004R4122	6/48	AF205-30-22-34	1SFL527002R3422	5/117	AF26Z-30-11-20	1SBL236601R2011	5/109
AF16-40-00-12	1SBL177201R1200	5/190	AF205-40-00-11	1SFL527102R1100	5/197	AF26Z-30-11-21	1SBL236601R2111	5/109
AF16-40-00-13	1SBL177201R1300	5/190	AF205-40-00-12	1SFL527102R1200	5/197	AF26Z-30-11-22	1SBL236601R2211	5/109
AF16-40-00-14	1SBL177201R1400	5/190	AF205-40-00-13	1SFL527102R1300	5/197	AF26Z-30-11-23	1SBL236601R2311	5/109
AF16-40-00-41	1SBL177201R4100	5/190	AF205-40-00-14	1SFL527102R1400	5/197	AF26Z-30-11S-20	1SBL236604R2011	6/49
AF1650-30-11	1SFL677001R7011	5/103	AF205-40-11-11	1SFL527102R1111	5/201	AF26Z-30-11S-21	1SBL236604R2111	6/49
AF1650-30-22	1SFL677001R7022	5/121	AF205-40-11-12	1SFL527102R1211	5/201	AF26Z-30-11S-22	1SBL236604R2211	6/49
AF1650-30T-11	1SFL677001R9101	5/105	AF205-40-11-13	1SFL527102R1311	5/201	AF26Z-30-11S-23	1SBL236604R2311	6/49
AF16Z-22-00-20	1SBL176501R2000	5/191	AF205-40-11-14	1SFL527102R1411	5/201	AF26Z-30-22-20	1SBL236601R2022	5/109
AF16Z-22-00-21	1SBL176501R2100	5/191	AF205-40-22-11	1SFL527102R1122	5/205	AF26Z-30-22-21	1SBL236601R2122	5/109
AF16Z-22-00-22	1SBL176501R2200	5/191	AF205-40-22-12	1SFL527102R1222	5/205	AF26Z-30-22-22	1SBL236601R2222	5/109
AF16Z-22-00-23	1SBL176501R2300	5/191	AF205-40-22-13	1SFL527102R1322	5/205	AF26Z-30-22-23	1SBL236601R2322	5/109
AF16Z-30-01-20	1SBL176001R2001	5/85	AF205-40-22-14	1SFL527102R1422	5/205	AF26Z-30-22S-20	1SBL236604R2022	6/49
AF16Z-30-01-21	1SBL176001R2101	5/85	AF26-22-00-12	1SBL237501R1200	5/190	AF26Z-30-22S-21	1SBL236604R2122	6/49
AF16Z-30-01-22	1SBL176001R2201	5/85	AF26-22-00-13	1SBL237501R1300	5/190	AF26Z-30-22S-22	1SBL236604R2222	6/49
AF16Z-30-01-23	1SBL176001R2301	5/85	AF26-22-00-14	1SBL237501R1400	5/190	AF26Z-30-22S-23	1SBL236604R2322	6/49
AF16Z-30-01S-20	1SBL176004R2001	6/47	AF26-22-00-41	1SBL237501R4100	5/190	AF26Z-40-00-20	1SBL236201R2000	5/191
AF16Z-30-01S-21	1SBL176004R2101	6/47	AF26-30-00-12	1SBL237001R1200	5/84	AF26Z-40-00-21	1SBL236201R2100	5/191
AF16Z-30-01S-22	1SBL176004R2201	6/47	AF26-30-00-13	1SBL237001R1300	5/6	AF26Z-40-00-22	1SBL236201R2200	5/191
AF16Z-30-01S-23	1SBL176004R2301	6/47	AF26-30-00-14	1SBL237001R1400	5/84	AF26Z-40-00-23	1SBL236201R2300	5/191
AF16Z-30-10-20	1SBL176001R2010	5/85	AF26-30-00-41	1SBL237001R4100	5/84	AF30-30-00-12	1SBL277001R1200	5/84
AF16Z-30-10-21	1SBL176001R2110	5/6	AF26-30-00S-12	1SBL237004R1200	6/46	AF30-30-00-13	1SBL277001R1300	5/6
AF16Z-30-10-22	1SBL176001R2210	5/85	AF26-30-00S-13	1SBL237004R1300	6/46	AF30-30-00-14	1SBL277001R1400	5/84
AF16Z-30-10-23	1SBL176001R2310	5/85	AF26-30-00S-14	1SBL237004R1400	6/46	AF30-30-00-41	1SBL277001R4100	5/84
AF16Z-30-10S-20	1SBL176004R2010	6/47	AF26-30-00S-41	1SBL237004R4100	6/46	AF30-30-11-12	1SBL277001R1211	5/108
AF16Z-30-10S-21	1SBL176004R2110	6/47	AF26-30-11-12	1SBL237001R1211	5/108	AF30-30-11-13	1SBL277001R1311	5/108
AF16Z-30-10S-22	1SBL176004R2210	6/47	AF26-30-11-13	1SBL237001R1311	5/108	AF30-30-11-14	1SBL277001R1411	5/108
AF16Z-30-10S-23	1SBL176004R2310	6/47	AF26-30-11-14	1SBL237001R1411	5/108	AF30-30-11-41	1SBL277001R4111	5/108
AF16Z-30-22-20	1SBL176001R2022	5/109	AF26-30-11-41	1SBL237001R4111	5/108	AF30-30-22-12	1SBL277001R1222	5/108
AF16Z-30-22-21	1SBL176001R2122	5/109	AF26-30-11S-12	1SBL237004R1211	6/48	AF30-30-22-13	1SBL277001R1322	5/108
AF16Z-30-22-22	1SBL176001R2222	5/109	AF26-30-11S-13	1SBL237004R1311	6/48	AF30-30-22-14	1SBL277001R1422	5/108
AF16Z-30-22-23	1SBL176001R2322	5/109	AF26-30-11S-14	1SBL237004R1411	6/48	AF30-30-22-41	1SBL277001R4122	5/108
AF16Z-30-22S-20	1SBL176004R2022	6/49	AF26-30-11S-41	1SBL237004R4111	6/48	AF305-30-00-11	1SFL587002R1100	5/92
AF16Z-30-22S-21	1SBL176004R2122	6/49	AF26-30-22-12	1SBL237001R1222	5/108	AF305-30-00-12	1SFL587002R1200	5/92
AF16Z-30-22S-22	1SBL176004R2222	6/49	AF26-30-22-13	1SBL237001R1322	5/108	AF305-30-00-13	1SFL587002R1300	5/92
AF16Z-30-22S-23	1SBL176004R2322	6/49	AF26-30-22-14	1SBL237001R1422	5/108	AF305-30-00-14	1SFL587002R1400	5/92
AF16Z-40-00-20	1SBL176201R2000	5/191	AF26-30-22-41	1SBL237001R4122	5/108	AF305-30-00-33	1SFL587002R3300	5/93
AF16Z-40-00-21	1SBL176201R2100	5/191	AF26-30-22S-12	1SBL237004R1222	6/48	AF305-30-00-34	1SFL587002R3400	5/93
AF16Z-40-00-22	1SBL176201R2200	5/191	AF26-30-22S-13	1SBL237004R1322	6/48	AF305-30-11-11	1SFL587002R1111	5/20
AF16Z-40-00-23	1SBL176201R2300	5/191	AF26-30-22S-14	1SBL2370				

Index

Type classification

Type	Order code	Page	Type	Order code	Page	Type	Order code	Page
AF305-30-22-12	1SFL587002R1222	5/116	AF38Z-30-11-23	1SBL296001R2311	5/109	AF65-30-22-13	1SBL387001R1322	5/110
AF305-30-22-13	1SFL587002R1322	5/116	AF38Z-30-22-20	1SBL296001R2022	5/109	AF65-30-22-14	1SBL387001R1422	5/110
AF305-30-22-14	1SFL587002R1422	5/116	AF38Z-30-22-21	1SBL296001R2122	5/109	AF65-30-22-41	1SBL387001R4122	5/110
AF305-30-22-33	1SFL587002R3322	5/117	AF38Z-30-22-22	1SBL296001R2222	5/109	AF750-30-11	1SFL637001R6811	5/102
AF305-30-22-34	1SFL587002R3422	5/117	AF38Z-30-22-23	1SBL296001R2322	5/109		1SFL637001R6911	5/102
AF305-40-00-11	1SFL587102R1100	5/197	AF38Z-40-00-20	1SBL296201R2000	5/191		1SFL637001R7011	5/102
AF305-40-00-12	1SFL587102R1200	5/197	AF38Z-40-00-21	1SBL296201R2100	5/191		1SFL637001R7111	5/102
AF305-40-00-13	1SFL587102R1300	5/197	AF38Z-40-00-22	1SBL296201R2200	5/191	AF750-30-22	1SFL637001R6822	5/120
AF305-40-00-14	1SFL587102R1400	5/197	AF38Z-40-00-23	1SBL296201R2300	5/191		1SFL637001R6922	5/120
AF305-40-11-11	1SFL587102R1111	5/201	AF400-30-11	1SFL577001R6811	5/102		1SFL637001R7022	5/120
AF305-40-11-12	1SFL587102R1211	5/201		1SFL577001R6911	5/102		1SFL637001R7122	5/120
AF305-40-11-13	1SFL587102R1311	5/201		1SFL577001R7011	5/102	AF80-22-00-11	1SBL397501R1100	5/192
AF305-40-11-14	1SFL587102R1411	5/201		1SFL577001R7111	5/102	AF80-22-00-12	1SBL397501R1200	5/192
AF305-40-22-11	1SFL587102R1122	5/205	AF400-30-22	1SFL577001R6822	5/120	AF80-22-00-13	1SBL397501R1300	5/192
AF305-40-22-12	1SFL587102R1222	5/205		1SFL577001R6922	5/120	AF80-22-00-14	1SBL397501R1400	5/192
AF305-40-22-13	1SFL587102R1322	5/205		1SFL577001R7022	5/120	AF80-22-00-41	1SBL397501R4100	5/192
AF305-40-22-14	1SFL587102R1422	5/205		1SFL577001R7122	5/120	AF80-30-00-11	1SBL397001R1100	5/6
AF30Z-30-00-20	1SBL276001R2000	5/85	AF40-22-00-11	1SBL347501R1100	5/192	AF80-30-00-12	1SBL397001R1200	5/86
AF30Z-30-00-21	1SBL276001R2100	5/6	AF40-22-00-12	1SBL347501R1200	5/192	AF80-30-00-13	1SBL397001R1300	5/6
AF30Z-30-00-22	1SBL276001R2200	5/85	AF40-22-00-13	1SBL347501R1300	5/192	AF80-30-00-14	1SBL397001R1400	5/86
AF30Z-30-00-23	1SBL276001R2300	5/85	AF40-22-00-14	1SBL347501R1400	5/192	AF80-30-00-41	1SBL397001R4100	5/86
AF30Z-30-11-20	1SBL276001R2011	5/109	AF40-22-00-41	1SBL347501R4100	5/192	AF80-30-11-11	1SBL397001R1111	5/111
AF30Z-30-11-21	1SBL276001R2111	5/109	AF40-30-00-11	1SBL347001R1100	5/6	AF80-30-11-12	1SBL397001R1211	5/111
AF30Z-30-11-22	1SBL276001R2211	5/109	AF40-30-00-12	1SBL347001R1200	5/86	AF80-30-11-13	1SBL397001R1311	5/111
AF30Z-30-11-23	1SBL276001R2311	5/109	AF40-30-00-13	1SBL347001R1300	5/6	AF80-30-11-14	1SBL397001R1411	5/111
AF30Z-30-22-20	1SBL276001R2022	5/109	AF40-30-00-14	1SBL347001R1400	5/86	AF80-30-11-41	1SBL397001R4111	5/111
AF30Z-30-22-21	1SBL276001R2122	5/109	AF40-30-00-41	1SBL347001R4100	5/86	AF80-30-22-11	1SBL397001R1122	5/111
AF30Z-30-22-22	1SBL276001R2222	5/109	AF40-30-11-11	1SBL347001R1111	5/110	AF80-30-22-12	1SBL397001R1222	5/111
AF30Z-30-22-23	1SBL276001R2322	5/109	AF40-30-11-12	1SBL347001R1211	5/110	AF80-30-22-13	1SBL397001R1322	5/111
AF370-30-00-11	1SFL607002R1100	5/92	AF40-30-11-13	1SBL347001R1311	5/110	AF80-30-22-14	1SBL397001R1422	5/111
AF370-30-00-12	1SFL607002R1200	5/92	AF40-30-11-14	1SBL347001R1411	5/110	AF80-30-22-41	1SBL397001R4122	5/111
AF370-30-00-13	1SFL607002R1300	5/92	AF40-30-11-41	1SBL347001R4111	5/110	AF80-40-00-11	1SBL397201R1100	5/192
AF370-30-00-14	1SFL607002R1400	5/92	AF40-30-22-11	1SBL347001R1122	5/110	AF80-40-00-12	1SBL397201R1200	5/192
AF370-30-00-33	1SFL607002R3300	5/93	AF40-30-22-12	1SBL347001R1222	5/110	AF80-40-00-13	1SBL397201R1300	5/192
AF370-30-00-34	1SFL607002R3400	5/93	AF40-30-22-13	1SBL347001R1322	5/110	AF80-40-00-14	1SBL397201R1400	5/192
AF370-30-11-11	1SFL607002R1111	5/22	AF40-30-22-14	1SBL347001R1422	5/110	AF80-40-00-41	1SBL397201R4100	5/192
AF370-30-11-12	1SFL607002R1211	5/98	AF40-30-22-41	1SBL347001R4122	5/110	AF96-30-00-11	1SBL407001R1100	5/6
AF370-30-11-13	1SFL607002R1311	5/22	AF40-40-00-11	1SBL347201R1100	5/192	AF96-30-00-12	1SBL407001R1200	5/86
AF370-30-11-14	1SFL607002R1411	5/98	AF40-40-00-12	1SBL347201R1200	5/192	AF96-30-00-13	1SBL407001R1300	5/6
AF370-30-11-33	1SFL607002R3311	5/99	AF40-40-00-13	1SBL347201R1300	5/192	AF96-30-00-14	1SBL407001R1400	5/86
AF370-30-11-34	1SFL607002R3411	5/99	AF40-40-00-14	1SBL347201R1400	5/192	AF96-30-00-41	1SBL407001R4100	5/86
AF370-30-22-11	1SFL607002R1122	5/116	AF40-40-00-41	1SBL347201R4100	5/192	AF96-30-11-11	1SBL407001R1111	5/111
AF370-30-22-12	1SFL607002R1222	5/116	AF460-30-11	1SFL597001R6811	5/102	AF96-30-11-12	1SBL407001R1211	5/111
AF370-30-22-13	1SFL607002R1322	5/116		1SFL597001R6911	5/102	AF96-30-11-13	1SBL407001R1311	5/111
AF370-30-22-14	1SFL607002R1422	5/116		1SFL597001R7011	5/102	AF96-30-11-14	1SBL407001R1411	5/111
AF370-30-22-33	1SFL607002R3322	5/117		1SFL597001R7111	5/102	AF96-30-11-41	1SBL407001R4111	5/111
AF370-30-22-34	1SFL607002R3422	5/117	AF460-30-22	1SFL597001R6822	5/120	AF96-30-22-11	1SBL407001R1122	5/111
AF370-40-00-11	1SFL607102R1100	5/197		1SFL597001R6922	5/120	AF96-30-22-12	1SBL407001R1222	5/111
AF370-40-00-12	1SFL607102R1200	5/197		1SFL597001R7022	5/120	AF96-30-22-13	1SBL407001R1322	5/111
AF370-40-00-13	1SFL607102R1300	5/197		1SFL597001R7122	5/120	AF96-30-22-14	1SBL407001R1422	5/111
AF370-40-00-14	1SFL607102R1400	5/197	AF52-30-00-11	1SBL367001R1100	5/6	AF96-30-22-41	1SBL407001R4122	5/111
AF370-40-11-11	1SFL607102R1111	5/201	AF52-30-00-12	1SBL367001R1200	5/86	AS09-30-01-20	1SBL101001R2001	4/14
AF370-40-11-12	1SFL607102R1211	5/201	AF52-30-00-13	1SBL367001R1300	5/6	AS09-30-01-26	1SBL101001R2601	4/14
AF370-40-11-13	1SFL607102R1311	5/201	AF52-30-00-14	1SBL367001R1400	5/86	AS09-30-01S-20	1SBL101004R2001	6/4
AF370-40-11-14	1SFL607102R1411	5/201	AF52-30-00-41	1SBL367001R4100	5/86	AS09-30-01S-26	1SBL101004R2601	6/4
AF370-40-22-11	1SFL607102R1122	5/205	AF52-30-11-11	1SBL367001R1111	5/110	AS09-30-10-20	1SBL101001R2010	4/10
AF370-40-22-12	1SFL607102R1222	5/205	AF52-30-11-12	1SBL367001R1211	5/110	AS09-30-10-26	1SBL101001R2610	4/10
AF370-40-22-13	1SFL607102R1322	5/205	AF52-30-11-13	1SBL367001R1311	5/110	AS09-30-10S-20	1SBL101004R2010	6/4
AF370-40-22-14	1SFL607102R1422	5/205	AF52-30-11-14	1SBL367001R1411	5/110	AS09-30-10S-26	1SBL101004R2610	6/4
AF38-22-00-12	1SBL297501R1200	5/190	AF52-30-11-41	1SBL367001R4111	5/110	AS09-30-32-20	1SBL101001R2032	4/34
AF38-22-00-13	1SBL297501R1300	5/190	AF52-30-22-11	1SBL367001R1122	5/110	AS09-30-32-26	1SBL101001R2632	4/34
AF38-22-00-14	1SBL297501R1400	5/190	AF52-30-22-12	1SBL367001R1222	5/110	AS09-30-32S-20	1SBL101004R2032	6/6
AF38-22-00-41	1SBL297501R4100	5/190	AF52-30-22-13	1SBL367001R1322	5/110	AS09-30-32S-26	1SBL101004R2632	6/6
AF38-30-00-12	1SBL297001R1200	5/84	AF52-30-22-14	1SBL367001R1422	5/110	AS12-30-01-20	1SBL111001R2001	4/14
AF38-30-00-13	1SBL297001R1300	5/36	AF52-30-22-41	1SBL367001R4122	5/110	AS12-30-01-26	1SBL111001R2601	4/14
AF38-30-00-14	1SBL297001R1400	5/84	AF52-40-00-11	1SBL367201R1100	5/192	AS12-30-01S-20	1SBL111004R2001	6/4
AF38-30-00-41	1SBL297001R4100	5/84	AF52-40-00-12	1SBL367201R1200	5/192	AS12-30-01S-26	1SBL111004R2601	6/4
AF38-30-11-12	1SBL297001R1211	5/108	AF52-40-00-13	1SBL367201R1300	5/192	AS12-30-10-20	1SBL111001R2010	4/10
AF38-30-11-13	1SBL297001R1311	5/108	AF52-40-00-14	1SBL367201R1400	5/192	AS12-30-10-26	1SBL111001R2610	4/10
AF38-30-11-14	1SBL297001R1411	5/108	AF52-40-00-41	1SBL367201R4100	5/192	AS12-30-10S-20	1SBL111004R2010	6/4
AF38-30-11-41	1SBL297001R4111	5/108	AF580-30-11	1SFL617001R6811	5/102	AS12-30-10S-26	1SBL111004R2610	6/4
AF38-30-22-12	1SBL297001R1222	5/108		1SFL617001R6911	5/102	AS12-30-32-20	1SBL111001R2032	4/34
AF38-30-22-13	1SBL297001R1322	5/108		1SFL617001R7011	5/102	AS12-30-32-26	1SBL111001R2632	4/34
AF38-30-22-14	1SBL297001R1422	5/108		1SFL617001R7111	5/102	AS12-30-32S-20	1SBL111004R2032	6/6
AF38-30-22-41	1SBL297001R4122	5/108	AF580-30-22	1SFL617001R6822	5/120	AS12-30-32S-26	1SBL111004R2632	6/6
AF38-40-00-12	1SBL297201R1200	5/190		1SFL617001R6922	5/120	AS16-30-01-20	1SBL121001R2001	4/14
AF38-40-00-13	1SBL297201R1300	5/190		1SFL617001R7022	5/120	AS16-30-01-26	1SBL121001R2601	4/14
AF38-40-00-14	1SBL297201R1400	5/190		1SFL617001R7122	5/120	AS16-30-01S-20	1SBL121004R2001	6/4
AF38-40-00-41	1SBL297201R4100	5/190	AF65-30-00-11	1SBL387001R1100	5/6	AS16-30-01S-26	1SBL121004R2601	6/4
AF38Z-22-00-20	1SBL296501R2000	5/191	AF65-30-00-12	1SBL387001R1200	5/86	AS16-30-10-20	1SBL121001R2010	4/10
AF38Z-22-00-21	1SBL296501R2100	5/191	AF65-30-00-13	1SBL387001R1300	5/6	AS16-30-10-26	1SBL121001R2610	4/10
AF38Z-22-00-22	1SBL296501R2200	5/191	AF65-30-00-14	1SBL387001R1400	5/86	AS16-30-10S-20	1SBL121004R2010	6/4
AF38Z-22-00-23	1SBL296501R2300	5/191	AF65-30-00-41	1SBL387001R4100	5/86	AS16-30-10S-26	1SBL121004R2610	6/4
AF38Z-30-00-20	1SBL296001R2000	5/85	AF65-30-11-11	1SBL387001R1111	5/110	AS16-30-32-20	1SBL121001R2032	4/34
AF38Z-30-00-21	1SBL296001R2100	5/36	AF65-30-11-12	1SBL387001R1211	5/110	AS16-30-32-26	1SBL121001R2632	4/34
AF38Z-30-00-22	1SBL296001R2200	5/85	AF65-30-11-13	1SBL387001R1311	5/110	AS16-30-32S-20	1SBL121004R2032	6/6
AF38Z-30-00-23	1SBL296001R2300	5/85	AF65-30-11-14	1SBL387001R1411	5/110	AS16-30-32S-26	1SBL121004R2632	6/6
AF38Z-30-11-20	1SBL296001R2011	5/109	AF65-30-11-41	1SBL387001R4111	5/110			

Index

Type classification

Type	Order code	Page
ASL09-30-10S-81	1SBL103004R8110	6/5
ASL09-30-32-81	1SBL103001R8132	4/35
ASL09-30-32S-81	1SBL103004R8132	6/7
ASL12-30-01-81	1SBL113001R8101	4/15
ASL12-30-01S-81	1SBL113004R8101	6/5
ASL12-30-10-81	1SBL113001R8110	4/11
ASL12-30-10S-81	1SBL113004R8110	6/5
ASL12-30-32-81	1SBL113001R8132	4/35
ASL12-30-32S-81	1SBL113004R8132	6/7
ASL16-30-01-81	1SBL123001R8101	4/15
ASL16-30-01S-81	1SBL123004R8101	6/5
ASL16-30-10-81	1SBL123001R8110	4/11
ASL16-30-10S-81	1SBL123004R8110	6/5
ASL16-30-32-81	1SBL123001R8132	4/35
ASL16-30-32S-81	1SBL123004R8132	6/7
AUX-C 1Q+1SY 24V DC	1SDA066446R1	2/42
AUX-C 1Q+1SY 250V AC	1SDA066431R1	2/42
AUX-C 2Q+1SY 250V AC	1SDA066433R1	2/42
AUX-C 2Q+2SY+1SA 250V AC	1SDA066438R1	2/42
AUX-C 3Q+1SY 250V AC	1SDA066434R1	2/42
AUX-C 3Q+2SY 250V AC	1SDA066436R1	2/42
B6-22-00-01	GJL1211501R0001	3/12
B6-22-00-02	GJL1211501R0002	3/12
B6-22-00-03	GJL1211501R0003	3/12
B6-22-00-80	GJL1211501R8000	3/12
B6-22-00-84	GJL1211501R8004	3/12
B6-30-01-01	GJL1211001R0011	3/4
B6-30-01-02	GJL1211001R0012	3/4
B6-30-01-03	GJL1211001R0013	3/4
B6-30-01-80	GJL1211001R8010	3/4
B6-30-01-84	GJL1211001R8014	3/4
B6-30-01-85	GJL1211001R8015	3/4
B6-30-01-F-01	GJL1211003R0011	3/29
B6-30-01-F-02	GJL1211003R0012	3/29
B6-30-01-F-03	GJL1211003R0013	3/29
B6-30-01-F-80	GJL1211003R8010	3/29
B6-30-01-F-84	GJL1211003R8014	3/29
B6-30-01-F-85	GJL1211003R8015	3/29
B6-30-01-P-01	GJL1211009R0011	3/19
B6-30-01-P-02	GJL1211009R0012	3/19
B6-30-01-P-03	GJL1211009R0013	3/19
B6-30-01-P-80	GJL1211009R8010	3/19
B6-30-01-P-84	GJL1211009R8014	3/19
B6-30-01-P-85	GJL1211009R8015	3/19
B6-30-10-01	GJL1211001R0101	3/4
B6-30-10-02	GJL1211001R0102	3/4
B6-30-10-03	GJL1211001R0103	3/4
B6-30-10-80	GJL1211001R8100	3/4
B6-30-10-84	GJL1211001R8104	3/4
B6-30-10-85	GJL1211001R8105	3/4
B6-30-10-F-01	GJL1211003R0101	3/29
B6-30-10-F-02	GJL1211003R0102	3/29
B6-30-10-F-03	GJL1211003R0103	3/29
B6-30-10-F-80	GJL1211003R8100	3/29
B6-30-10-F-84	GJL1211003R8104	3/29
B6-30-10-F-85	GJL1211003R8105	3/29
B6-30-10-P-01	GJL1211009R0101	3/19
B6-30-10-P-02	GJL1211009R0102	3/19
B6-30-10-P-03	GJL1211009R0103	3/19
B6-30-10-P-80	GJL1211009R8100	3/19
B6-30-10-P-84	GJL1211009R8104	3/19
B6-30-10-P-85	GJL1211009R8105	3/19
B6-40-00-01	GJL1211201R0001	3/12
B6-40-00-02	GJL1211201R0002	3/12
B6-40-00-03	GJL1211201R0003	3/12
B6-40-00-80	GJL1211201R8000	3/12
B6-40-00-84	GJL1211201R8004	3/12
B6-40-00-84	GJL1211201R8004	3/12
B6S-30-01-1.7-71	GJL1213001R7011	3/10
B6S-30-01-2.8-72	GJL1213001R7012	3/10
B6S-30-10-1.7-71	GJL1213001R7101	3/10
B6S-30-10-2.8-72	GJL1213001R7102	3/10
B7-22-00-01	GJL1311501R0001	3/12
B7-22-00-02	GJL1311501R0002	3/12
B7-22-00-03	GJL1311501R0003	3/12
B7-22-00-80	GJL1311501R8000	3/12
B7-22-00-84	GJL1311501R8004	3/12
B7-30-01-01	GJL1311001R0011	3/4
B7-30-01-02	GJL1311001R0012	3/4
B7-30-01-03	GJL1311001R0013	3/4
B7-30-01-80	GJL1311001R8010	3/4
B7-30-01-84	GJL1311001R8014	3/4
B7-30-01-85	GJL1311001R8015	3/4
B7-30-01-F-01	GJL1311003R0011	3/29
B7-30-01-F-02	GJL1311003R0012	3/29
B7-30-01-F-03	GJL1311003R0013	3/29
B7-30-01-F-80	GJL1311003R8010	3/29
B7-30-01-F-84	GJL1311003R8014	3/29
B7-30-01-F-85	GJL1311003R8015	3/29
B7-30-01-P-01	GJL1311009R0011	3/19
B7-30-01-P-02	GJL1311009R0012	3/19

Type	Order code	Page
B7-30-01-P-03	GJL1311009R0013	3/19
B7-30-01-P-80	GJL1311009R8010	3/19
B7-30-01-P-84	GJL1311009R8014	3/19
B7-30-01-P-85	GJL1311009R8015	3/19
B7-30-10-01	GJL1311001R0101	3/4
B7-30-10-02	GJL1311001R0102	3/4
B7-30-10-03	GJL1311001R0103	3/4
B7-30-10-80	GJL1311001R8100	3/4
B7-30-10-84	GJL1311001R8104	3/4
B7-30-10-85	GJL1311001R8105	3/4
B7-30-10-F-01	GJL1311003R0101	3/29
B7-30-10-F-02	GJL1311003R0102	3/29
B7-30-10-F-03	GJL1311003R0103	3/29
B7-30-10-F-80	GJL1311003R8100	3/29
B7-30-10-F-84	GJL1311003R8104	3/29
B7-30-10-F-85	GJL1311003R8105	3/29
B7-30-10-P-01	GJL1311009R0101	3/19
B7-30-10-P-02	GJL1311009R0102	3/19
B7-30-10-P-03	GJL1311009R0103	3/19
B7-30-10-P-80	GJL1311009R8100	3/19
B7-30-10-P-84	GJL1311009R8104	3/19
B7-30-10-P-85	GJL1311009R8105	3/19
B7-40-00-01	GJL1311201R0001	3/12
B7-40-00-02	GJL1311201R0002	3/12
B7-40-00-03	GJL1311201R0003	3/12
B7-40-00-80	GJL1311201R8000	3/12
B7-40-00-84	GJL1311201R8004	3/12
B7D-30-01-01	GJL1317001R0011	3/5
B7D-30-01-05	GJL1317001R0015	3/5
B7D-30-10-01	GJL1317001R0101	3/5
B7D-30-10-05	GJL1317001R0105	3/5
B7D-40-00-01	GJL1317201R0001	3/13
B7D-40-00-05	GJL1317201R0005	3/13
B7S-30-01-1.7-71	GJL1313001R7011	3/10
B7S-30-01-2.8-72	GJL1313001R7012	3/10
B7S-30-10-1.7-71	GJL1313001R7101	3/10
B7S-30-10-2.8-72	GJL1313001R7102	3/10
BA4	1SNA235156R2700	4/82
BA5-50	1SBN110009R1000	3/39
BB3	1SBN111020R1000	4/82
BB4	1SBN111021R1000	5/352
BC6-21-10-P-01	GJL1213109R0101	3/20
BC6-21-10-P-03	GJL1213109R0103	3/20
BC6-21-10-P-04	GJL1213109R0104	3/20
BC6-21-10-P-05	GJL1213109R0105	3/20
BC6-21-10-P-16	GJL1213109R1106	3/20
BC6-22-00-01	GJL1213501R0001	3/13
BC6-22-00-02	GJL1213501R0002	3/13
BC6-22-00-03	GJL1213501R0003	3/13
BC6-22-00-04	GJL1213501R0004	3/13
BC6-22-00-05	GJL1213501R0005	3/13
BC6-22-00-07	GJL1213501R0007	3/13
BC6-22-00-16	GJL1213501R1006	3/13
BC6-30-01-01	GJL1213001R0011	3/5
BC6-30-01-03	GJL1213001R0013	3/5
BC6-30-01-04	GJL1213001R0014	3/5
BC6-30-01-05	GJL1213001R0015	3/5
BC6-30-01-07	GJL1213001R0017	3/5
BC6-30-01-1.4-81	GJL1213001R8011	3/10
BC6-30-01-16	GJL1213001R1016	3/5
BC6-30-01-2.4-51	GJL1213001R5011	3/10
BC6-30-01-F-01	GJL1213003R0011	3/30
BC6-30-01-F-03	GJL1213003R0013	3/30
BC6-30-01-F-04	GJL1213003R0014	3/30
BC6-30-01-F-05	GJL1213003R0015	3/30
BC6-30-01-F-07	GJL1213003R0017	3/30
BC6-30-01-F-1.4-81	GJL1213003R8011	3/35
BC6-30-01-F-16	GJL1213003R1016	3/30
BC6-30-01-F-2.4-51	GJL1213003R5011	3/35
BC6-30-01-P-01	GJL1213009R0011	3/20
BC6-30-01-P-03	GJL1213009R0013	3/20
BC6-30-01-P-04	GJL1213009R0014	3/20
BC6-30-01-P-05	GJL1213009R0015	3/20
BC6-30-01-P-07	GJL1213009R0017	3/20
BC6-30-01-P-1.4-81	GJL1213009R8011	3/27
BC6-30-01-P-16	GJL1213009R1016	3/20
BC6-30-01-P-2.4-51	GJL1213009R5011	3/27
BC6-30-10-01	GJL1213001R0101	3/5
BC6-30-10-03	GJL1213001R0103	3/5
BC6-30-10-04	GJL1213001R0104	3/5
BC6-30-10-05	GJL1213001R0105	3/5
BC6-30-10-07	GJL1213001R0107	3/5
BC6-30-10-1.4-81	GJL1213001R8101	3/10
BC6-30-10-16	GJL1213001R1106	3/5
BC6-30-10-2.4-51	GJL1213001R5101	3/10
BC6-30-10-F-01	GJL1213003R0101	3/30
BC6-30-10-F-03	GJL1213003R0103	3/30
BC6-30-10-F-04	GJL1213003R0104	3/30
BC6-30-10-F-05	GJL1213003R0105	3/30
BC6-30-10-F-07	GJL1213003R0107	3/30

Type	Order code	Page
BC6-30-10-F-1.4-81	GJL1213003R8101	3/35
BC6-30-10-F-16	GJL1213003R1106	3/30
BC6-30-10-F-2.4-51	GJL1213003R5101	3/35
BC6-30-10-P-01	GJL1213009R0101	3/20
BC6-30-10-P-03	GJL1213009R0103	3/20
BC6-30-10-P-04	GJL1213009R0104	3/20
BC6-30-10-P-05	GJL1213009R0105	3/20
BC6-30-10-P-07	GJL1213009R0107	3/20
BC6-30-10-P-1.4-81	GJL1213009R8101	3/27
BC6-30-10-P-16	GJL1213009R1106	3/20
BC6-30-10-P-2.4-51	GJL1213009R5101	3/27
BC7-30-01-01	GJL1313001R0011	3/5
BC7-30-01-03	GJL1313001R0013	3/5
BC7-30-01-04	GJL1313001R0014	3/5
BC7-30-01-05	GJL1313001R0015	3/5
BC7-30-01-07	GJL1313001R0017	3/5
BC7-30-01-1.4-81	GJL1313001R8011	3/10
BC7-30-01-16	GJL1313001R1016	3/5
BC7-30-01-2.4-51	GJL1313001R5011	3/10
BC7-30-01-F-01	GJL1313003R0011	3/30
BC7-30-01-F-03	GJL1313003R0013	3/30
BC7-30-01-F-04	GJL1313003R0014	3/30
BC7-30-01-F-05	GJL1313003R0015	3/30
BC7-30-01-F-07	GJL1313003R0017	3/30
BC7-30-01-F-1.4-81	GJL1313003R8011	3/35
BC7-30-01-F-16	GJL1313003R1016	3/30
BC7-30-01-F-2.4-51	GJL1313003R5011	3/35
BC7-30-01-P-01	GJL1313009R0011	3/20
BC7-30-01-P-03	GJL1313009R0013	3/20
BC7-30-01-P-04	GJL1313009R0014	3/20
BC7-30-01-P-05	GJL1313009R0015	3/20
BC7-30-01-P-07	GJL1313009R0017	3/20
BC7-30-01-P-1.4-81	GJL1313009R8011	3/27
BC7-30-01-P-16	GJL1313009R1016	3/20
BC7-30-01-P-2.4-51	GJL1313009R5011	3/27
BC7-30-10-01	GJL1313001R0101	3/5
BC7-30-10-03	GJL1313001R1103	3/5
BC7-30-10-04	GJL1313001R1014	3/5
BC7-30-10-05	GJL1313001R1015	3/5
BC7-30-10-07	GJL1313001R0107	3/5
BC7-30-10-1.4-81	GJL1313001R8101	3/10
BC7-30-10-16	GJL1313001R1106	3/5
BC7-30-10-2.4-51	GJL1313001R5101	3/10
BC7-30-10-F-01	GJL1313003R0101	3/30
BC7-30-10-F-03	GJL1313003R0103	3/30
BC7-30-10-F-04	GJL1313003R0104	3/30
BC7-30-10-F-05	GJL1313003R0105	3/30
BC7-30-10-F-07	GJL1313003R0107	3/30
BC7-30-10-F-1.4-81	GJL1313003R8101	3/35
BC7-30-10-F-16	GJL1313003R1106	3/30
BC7-30-10-F-2.4-51	GJL1313003R5101	3/35
BC7-30-10-P-01	GJL1313009R0011	3/20
BC7-30-10-P-03	GJL1313009R0013	3/20
BC7-30-10-P-04	GJL1313009R0014	3/20
BC7-30-10-P-05	GJL1313009R0015	3/20
BC7-30-10-P-07	GJL1313009R0017	3/20
BC7-30-10-P-1.4-81	GJL1313009R8101	3/27
BC7-30-10-P-16	GJL1313009R1106	3/20
BC7-30-10-P-2.4-51	GJL1313009R5101	3/27
BDT4	1SBN110122T1000	4/82
BEA140/XT2	1SBN084206R1000	5/20
BEA140/XT4	1SBN084206R1001	5/369
BEA16-3	1SBN081006T1000	4/10
BEA16-3U	1SBN081020R10	

Index

Type classification

Type	Order code	Page	Type	Order code	Page	Type	Order code	Page
BEP370-40	1SFN085414R2000	5/367	CA6-11N-F	GJL1201318R0004	3/39	DRAS09-29P	1SBK104035R2900	8/2
BER140-4	1SFN084211R1000	5/37	CA6-11N-P	GJL1201319R0004	3/39	DRAS12-20S	1SBK114235R2000	8/2
BER16-4	1SFN081311R1000	5/37	CAF6-02E	GJL1201330R0010	3/39	DRAS12-26N	1SBK114135R2600	8/2
BER16C-3	1SFN081012R1000	4/21	CAF6-02K	GJL1201330R0009	3/40	DRAS12-27N	1SBK114135R2700	8/2
BER205-4	1SFN084811R1000	5/37	CAF6-02M	GJL1201330R0011	3/39	DRAS12-28P	1SBK114035R2800	8/2
BER370-4	1SFN085411R1000	5/39	CAF6-02N	GJL1201330R0012	3/39	DRAS12-29P	1SBK114035R2900	8/2
BER38-4	1SFN082311R1000	5/37	CAF6-11E	GJL1201330R0002	3/39	DRAS16-20S	1SBK124235R2000	8/2
BER65-4	1SFN083411R1000	5/37	CAF6-11K	GJL1201330R0001	3/40	DRAS16-26N	1SBK124135R2600	8/2
BER96-4	1SFN083911R1000	5/8	CAF6-11M	GJL1201330R0003	3/39	DRAS16-27N	1SBK124135R2700	8/2
BES460	1SFN085704R1000	5/367	CAF6-11N	GJL1201330R0004	3/39	DRAS16-28P	1SBK124035R2800	8/2
BES750	1SFN086104R1000	5/367	CAF6-20E	GJL1201330R0006	3/39	DRAS16-29P	1SBK124035R2900	8/2
BEY140-4	1SFN084413R1000	5/60	CAF6-20K	GJL1201330R0005	3/40	DRASL09-81S	1SBK104335R8100	8/2
BEY16-4	1SFN081313R2000	5/60	CAF6-20M	GJL1201330R0007	3/39	DRASL09-83S	1SBK104335R8300	8/2
BEY16C-3	1SFN081018R2000	4/24	CAF6-20N	GJL1201330R0008	3/39	DRASL12-81S	1SBK114335R8100	8/2
BEY190-4	1SFN084813R1000	5/60	CAL16-11A	SK829002-A	5/400	DRASL12-83S	1SBK114335R8300	8/2
BEY205-4	1SFN085213R1000	5/62	CAL16-11B	SK829002-B	5/213	DRASL16-81S	1SBK124335R8100	8/2
BEY265-4	1SFN085413R1000	5/62	CAL16-11C	SK829002-C	5/213	DRASL16-83S	1SBK124335R8300	8/2
BEY370-4	1SFN085813R1000	5/62	CAL16-11D	SK829002-D	5/213	DX495	1SAM401912R1001	2/44
BEY38-4	1SFN082713R2000	5/60	CAL18-11	1SFN010720R1011	5/107	E1250DU-1250	1SFA739001R1000	7/43
BEY65-4	1SFN083413R2000	5/60	CAL18-11B	1SFN010720R3311	5/107	E16DU-0.32	1SAX111001R1101	7/28
BEY96-4	1SFN083913R2000	5/60	CAL19-11	1SFN010820R1011	5/95	E16DU-1.0	1SAX111001R1102	7/28
BP16	1SFN111403R1000	5/388	CAL19-11B	1SFN010820R3311	5/95	E16DU-18.9	1SAX111001R1105	7/28
BP38-4	1SFN112303T1000	5/361	CAL4-11	1SFN010120R1011	5/89	E16DU-2.7	1SAX111001R1103	7/28
BP65-4	1SFN113403T1000	5/361	CAL4-11S	1SFN010130R1011	6/51	E16DU-6.3	1SAX111001R1104	7/28
BP96-4	1SFN113903T1000	5/361	CAL4-11-T	1SFN010120T1011	5/89	EF146-150	1SAX351001R1101	5/22
BS1-3	1SAM201908R1001	2/28	CAL5-11	1SFN010020R1011	5/376	EF19-0.32	1SAX121001R1101	7/28
BS2-3	1SAM401921R1001	2/29	CAT4-11E	1SFN010151R1011	5/89	EF19-1.0	1SAX121001R1102	7/28
BSM6-30	GJL1201908R0001	3/39	CAT4-11ES	1SFN010153R1011	6/51	EF19-18.9	1SAX121001R1105	5/38
BSS1000	SK829090-H	5/213	CAT4-11M	1SFN010151R1111	5/89	EF19-2.7	1SAX121001R1103	7/28
BSS550	SK829090-E	5/213	CAT4-11MS	1SFN010153R1111	6/51	EF19-6.3	1SAX121001R1104	7/28
BX4	1SFN110108T1000	5/321	CAT4-11U	1SFN010151R1311	5/89	EF205-210	1SAX531001R1101	5/22
BX4-CA	1SFN110109W1000	5/321	CAT4-11US	1SFN010153R1311	6/51	EF370-380	1SAX611001R1101	5/22
CA3-01	1SFN011010T1001	4/37	CB5-01	1SFN010013R1001	5/354	EF45-30	1SAX221001R1101	5/38
CA3-01S	1SFN011019T1001	6/9	CB5-10	1SFN010013R1010	5/354	EF45-45	1SAX221001R1102	5/38
CA3-10	1SFN011010T1010	4/37	CC4-01	1SFN010111R1001	5/89	EF460-500	1SAX721001R1101	7/40
CA3-10S	1SFN011019T1010	6/9	CC4-10	1SFN010111R1010	5/89	EF65-56	1SAX331001R1102	7/32
CA4-01	1SFN010110R1001	5/89	CC5-01	1SFN010011R1001	5/376	EF65-70	1SAX331001R1101	5/38
CA4-01S	1SFN010119R1001	6/51	CC5-10	1SFN010011R1010	5/376	EF750-800	1SAX821001R1101	7/40
CA4-01S-T	1SFN010119T1001	6/51	CCL16-11E	SK829002-E	5/213	EF96-100	1SAX341001R1101	5/38
CA4-01-T	1SFN010110T1001	5/89	CCL16-11E	SK829002-E	5/400	EK1000-40-11	SK827044-AD	5/208
CA4-04E	1SFN010140R1004	5/195	CE5-01D0.1	1SFN010015R1001	5/338		SK827044-AR	5/208
CA4-04M	1SFN010140R1104	5/336	CE5-01D2	1SFN010017R1001	5/338		SK827044-EF	5/208
CA4-04N	1SFN010140R1204	5/321	CE5-01W0.1	1SFN010016R1001	5/338		SK827044-EG	5/208
CA4-10	1SFN010110R1010	5/89	CE5-01W2	1SFN010018R1001	5/338		SK827044-EL	5/208
CA4-10S	1SFN010119R1010	6/51	CE5-10D0.1	1SFN010015R1010	5/338		SK827044-EM	5/208
CA4-10S-T	1SFN010119T1010	6/51	CE5-10D2	1SFN010017R1010	5/338		SK827044-EP	5/208
CA4-10-T	1SFN010110T1010	5/89	CE5-10W0.1	1SFN010016R1010	5/338		SK827044-ER	5/208
CA4-13M	1SFN010140R1113	5/336	CE5-10W2	1SFN010018R1010	5/338	EK1000-40-21	SK827044-DB	5/209
CA4-13N	1SFN010140R1213	5/321	CEL18-01	1SFN010716R1001	5/257		SK827044-DC	5/209
CA4-22E	1SFN010140R1022	5/89	CEL18-10	1SFN010716R1010	5/257		SK827044-DD	5/209
CA4-22ES	1SFN010145R1022	6/51	CEL19-01	1SFN010832R1001	5/344		SK827044-DE	5/209
CA4-22M	1SFN010140R1122	5/89	CEL19-10	1SFN010832R1010	5/344		SK827044-DF	5/209
CA4-22MS	1SFN010145R1122	6/51	CK1-02	1SAM301901R1003	2/23		SK827044-DG	5/209
CA4-22N	1SFN010140R1222	5/321	CK1-11	1SAM301901R1001	2/23		SK827044-DT	5/209
CA4-22NS	1SFN010145R1222	6/73	CK1-20	1SAM301901R1002	2/23		SK827044-DU	5/209
CA4-22U	1SFN010140R1322	5/89	CT-ERS.21S	1SVR730100R0300	5/60	EK1000-40-22	SK827045-AD	5/210
CA4-31E	1SFN010140R1031	5/195	CT-SDS.22S	1SVR730210R3300	4/25		SK827045-AR	5/210
CA4-31ES	1SFN010145R1031	6/51	CT-SDS.23S	1SVR730211R2300	4/25		SK827045-EF	5/210
CA4-31M	1SFN010140R1131	5/336	DB16	1SAZ701901R0001	7/4		SK827045-EG	5/210
CA4-31MS	1SFN010145R1131	6/51	DB16E	1SAX101110R0001	7/28		SK827045-EL	5/210
CA4-31N	1SFN010140R1231	5/321	DB19EF	1SAX101910R1001	7/28		SK827045-EM	5/210
CA4-31NS	1SFN010145R1231	6/73	DB200	1SAZ401110R0001	7/24		SK827045-EP	5/210
CA4-31U	1SFN010140R1331	5/336	DB42	1SAZ701902R0001	7/8		SK827045-ER	5/210
CA4-40E	1SFN010140R1040	5/195	DB45EF	1SAX201910R0001	7/28	EK550-40-11	SK827041-AD	5/208
CA4-40ES	1SFN010145R1040	6/51	DB65	1SAZ801901R1001	7/12		SK827041-AR	5/208
CA4-40N	1SFN010140R1240	5/321	DB96	1SAZ901901R1001	7/16		SK827041-EF	5/208
CA4-40NS	1SFN010145R1240	6/73	DMS132-G	1SAM201912R1010	2/31		SK827041-EG	5/208
CA4-40U	1SFN010140R1340	5/336	DMS132-Y	1SAM201912R1011	2/31		SK827041-EL	5/208
CA5-01	1SFN010010R1001	5/376	DRAF09-11S	1SBK134237R1100	8/8		SK827041-EM	5/208
CA5-04E	1SFN010040R1004	5/376	DRAF09-11U	1SBK134238R1100	8/8		SK827041-EP	5/208
CA5-04M	1SFN010040R1104	5/376	DRAF09-13N	1SBK134137R1300	8/8		SK827041-ER	5/208
CA5-10	1SFN010010R1010	5/376	DRAF09-13U	1SBK134238R1300	8/8	EK550-40-21	SK827041-DB	5/209
CA5-11/11E	1SFN010040R1018	5/376	DRAF09-14P	1SBK134037R1400	8/8		SK827041-DC	5/209
CA5-11/11M	1SFN010040R1118	5/376	DRAF09-14U	1SBK134238R1400	8/8		SK827041-DD	5/209
CA5-13M	1SFN010040R1113	5/376	DRAF12-11S	1SBK154237R1100	8/8		SK827041-DE	5/209
CA5-22E	1SFN010040R1022	5/376	DRAF12-11U	1SBK154238R1100	8/8		SK827041-DF	5/209
CA5-22M	1SFN010040R1122	5/376	DRAF12-13N	1SBK154137R1300	8/8		SK827041-DG	5/209
CA5-31E	1SFN010040R1031	5/376	DRAF12-13U	1SBK154238R1300	8/8		SK827041-DT	5/209
CA5-31M	1SFN010040R1131	5/376	DRAF12-14P	1SBK154037R1400	8/8		SK827041-DU	5/209
CA5-40E	1SFN010040R1040	5/376	DRAF12-14U	1SBK154238R1400	8/8	EK550-40-22	SK827043-AD	5/210
CA6-11E	GJL1201317R0002	3/39	DRAF16-11S	1SBK174237R1100	8/8		SK827043-AR	5/210
CA6-11E-F	GJL1201318R0002	3/39	DRAF16-11U	1SBK174238R1100	8/8		SK827043-EF	5/210
CA6-11E-P	GJL1201319R0002	3/39	DRAF16-13N	1SBK174137R1300	8/8		SK827043-EG	5/210
CA6-11K	GJL1201317R0001	3/40	DRAF16-13U	1SBK174238R1300	8/8		SK827043-EL	5/210
CA6-11K-F	GJL1201318R0001	3/40	DRAF16-14P	1SBK174037R1400	8/8		SK827043-EM	5/210
CA6-11K-P	GJL1201319R0001	3/40	DRAF16-14U	1SBK174238R1400	8/8		SK827043-EP	5/210
CA6-11M	GJL1201317R0003	3/39	DRAS09-20S	1SBK104235R2000	8/2		SK827043-ER	5/210
CA6-11M-F	GJL1201318R0003	3/39	DRAS09-26N	1SBK104135R2600	8/2	Ekip M-LiU In160	1SDA067355R1	5/20
CA6-11M-P	GJL1201319R0003	3/39	DRAS09-27N	1SBK104135R2700	8/2	FR16AF-12	1SFN101337R1000	8/9
CA6-11N	GJL1201317R0004	3/39	DRAS09-28P	1SBK104035R2800	8/2	FR16AF-12U	1SFN101338R1000	8/9
						FR16AS-12VARS	1SFN101035R1000	8/2

Index

Type classification

Type	Order code	Page	Type	Order code	Page	Type	Order code	Page
FS116	1SAM201909R1001	2/28	K6-31Z-85	GJH1211001R8315	3/15	KC6-40E-F-51	GJH1213003R5401	3/38
GA75-10-00	1SBL411025R8000	5/252	K6-31Z-F-01	GJH1211003R0311	3/36	KC6-40E-P-01	GJH1213009R0401	3/26
	1SBL411025R8100	5/252	K6-31Z-F-02	GJH1211003R0312	3/36	KC6-40E-P-04	GJH1213009R0404	3/26
	1SBL411025R8300	5/252	K6-31Z-F-03	GJH1211003R0313	3/36	KC6-40E-P-05	GJH1213009R0405	3/26
	1SBL411025R8400	5/252	K6-31Z-F-80	GJH1211003R8310	3/36	KC6-40E-P-07	GJH1213009R0407	3/26
	1SBL411025R8500	5/252	K6-31Z-F-84	GJH1211003R8314	3/36	KC6-40E-P-1.4-81	GJH1213009R8401	3/28
	1SBL411025R8600	5/252	K6-31Z-F-85	GJH1211003R8315	3/36	KC6-40E-P-16	GJH1213009R1406	3/26
	1SBL411025R8800	5/252	K6-31Z-P-01	GJH1211009R0311	3/25	KC6-40E-P-2.4-51	GJH1213009R5401	3/28
GA75-10-11	1SBL411025R8011	5/252	K6-31Z-P-02	GJH1211009R0312	3/25	KH800	SK828100-AD	5/409
	1SBL411025R8111	5/252	K6-31Z-P-03	GJH1211009R0313	3/25		SK828100-AR	5/409
	1SBL411025R8311	5/252	K6-31Z-P-80	GJH1211009R8310	3/25		SK828100-EF	5/409
	1SBL411025R8411	5/252	K6-31Z-P-84	GJH1211009R8314	3/25		SK828100-EG	5/409
	1SBL411025R8511	5/252	K6-31Z-P-85	GJH1211009R8315	3/25		SK828100-EL	5/409
	1SBL411025R8611	5/252	K6-40E-01	GJH1211001R0401	3/15		SK828100-EM	5/409
	1SBL411025R8811	5/252	K6-40E-02	GJH1211001R0402	3/15		SK828100-EP	5/409
GAE75-10-00	1SBL419025R8000	5/253	K6-40E-03	GJH1211001R0403	3/15		SK828100-ER	5/409
	1SBL419025R8100	5/253	K6-40E-80	GJH1211001R8400	3/15	KLC Ronis	1SDA066593R1	2/42
	1SBL419025R8300	5/253	K6-40E-84	GJH1211001R8404	3/15		1SDA066599R1	2/42
	1SBL419025R8400	5/253	K6-40E-85	GJH1211001R8405	3/15	KM1 : 1 x CA4-10	1SBN010110R1010	5/60
	1SBL419025R8600	5/253	K6-40E-F-01	GJH1211003R0401	3/36	KM1 : 1 x CA4-10	1SBN010110R1001	5/60
	1SBL419025R8700	5/253	K6-40E-F-02	GJH1211003R0402	3/36	KM1: 1 x CA3-10	1SBN011010T1010	4/24
	1SBL419025R8800	5/253	K6-40E-F-03	GJH1211003R0403	3/36	KP800	SK828150-DB	5/409
	1SBL419025R8900	5/253	K6-40E-F-80	GJH1211003R8400	3/36		SK828150-DC	5/409
GAE75-10-11	1SBL419025R8011	5/253	K6-40E-F-84	GJH1211003R8404	3/36		SK828150-DD	5/409
	1SBL419025R8111	5/253	K6-40E-F-85	GJH1211003R8405	3/36		SK828150-DE	5/409
	1SBL419025R8311	5/253	K6-40E-P-01	GJH1211009R0401	3/25		SK828150-DF	5/409
	1SBL419025R8411	5/253	K6-40E-P-02	GJH1211009R0402	3/25		SK828150-DG	5/409
	1SBL419025R8611	5/253	K6-40E-P-03	GJH1211009R0403	3/25		SK828150-DT	5/409
	1SBL419025R8711	5/253	K6-40E-P-80	GJH1211009R8400	3/25		SK828150-DU	5/409
	1SBL419025R8811	5/253	K6-40E-P-84	GJH1211009R8404	3/25	KPR-101L	1SFA61162R1014	7/4
	1SBL419025R8911	5/253	K6-40E-P-85	GJH1211009R8405	3/25	KWK1000	5223351-AN	5/408
GAF1250-10-11	1SFL647025R6811	5/256	K6S-22Z-1.7-71	GJH1213001R7221	3/17	KWK550	5223351-Z	5/408
	1SFL647025R6911	5/256	K6S-22Z-2.8-72	GJH1213001R7222	3/17	KZK1000	SK827204-F	5/408
	1SFL647025R7011	5/256	K6S-31Z-1.7-71	GJH1213001R7311	3/17	KZK550	SK827204-B	5/408
	1SFL647025R7111	5/256	K6S-31Z-2.8-72	GJH1213001R7312	3/17	LB6	GJL1201902R0001	3/39
GAF1650-10-11	1SFL677025R7011	5/256	K6S-40E-1.7-71	GJH1213001R7401	3/17	LB6-CA	GJL1201903R0001	3/39
GAF185-10-11	1SFL497025R6911	5/254	K6S-40E-2.8-72	GJH1213001R7402	3/17	LD146-30	1SFN074208R1000	5/365
	1SFL497025R7011	5/254	KA165	1SAM401922R1001	2/29	LD146-40	1SFN074208R2000	5/365
GAF185-10-11	1SFL497025R7211	5/254	KA495	1SAM501901R1001	2/44	LD38-4	1SBN072308R1000	5/362
GAF2050-10-11	1SFL707025R7011	5/256	KA495C	1SAM501902R1001	2/44	LD75	1SBN073508R1000	5/395
GAF300-10-11	1SFL557025R6911	5/254	KC6-22Z-01	GJH1213001R0221	3/16	LDC4	1SBN070156T1000	5/321
	1SFL557025R7011	5/254	KC6-22Z-03	GJH1213001R0223	3/16	LDC4S	1SBN070157T1000	6/51
GAF300-10-11	1SFL557025R7211	5/254	KC6-22Z-04	GJH1213001R0224	3/16	LF16-4	1SBN071305R1000	5/366
GAF460-10-11	1SFL597025R6911	5/255	KC6-22Z-05	GJH1213001R0225	3/16	LF38-4	1SBN072305R1000	5/366
	1SFL597025R7011	5/255	KC6-22Z-07	GJH1213001R0227	3/16	LG16-4	1SBN071306R1000	5/366
	1SFL597025R7111	5/255	KC6-22Z-16	GJH1213001R1226	3/16	LH38-4	1SBN072304R1000	5/366
GAF460-10-11	1SFL597025R6811	5/255	KC6-22Z-F-01	GJH1213003R0221	3/37	LK75-F	1SBN073552R1002	5/396
GAF750-10-11	1SFL637025R6911	5/255	KC6-22Z-F-04	GJH1213003R0224	3/37	LK75-L	1SBN073552R1003	5/396
	1SFL637025R7011	5/255	KC6-22Z-F-05	GJH1213003R0225	3/37	LK96-4B	1SBN073452R3000	5/364
	1SFL637025R7111	5/255	KC6-22Z-F-07	GJH1213003R0227	3/37	LK96-4F	1SBN073452R2000	5/364
GAF750-10-11	1SFL637025R6811	5/255	KC6-22Z-F-16	GJH1213003R1226	3/37	LK96-4L	1SBN073452R1000	5/364
HK1-02	1SAM201902R1003	2/23	KC6-22Z-P-01	GJH1213009R0221	3/26	LL146-30	1SFN074211R1000	5/365
HK1-11	1SAM201902R1001	2/23	KC6-22Z-P-04	GJH1213009R0224	3/26	LL146-40	1SFN074211R2000	5/365
HK1-20	1SAM201902R1002	2/23	KC6-22Z-P-05	GJH1213009R0225	3/26	LL205-40	1SFN074811R2000	5/365
HK1-20L	1SAM201902R1004	2/23	KC6-22Z-P-07	GJH1213009R0227	3/26	LL370-40	1SFN075411R2000	5/365
HK4-11	1SAM401901R1001	2/44	KC6-22Z-P-16	GJH1213009R1226	3/26	LP1250	1SFN076412R1000	5/257
HK4-W	1SAM401901R1002	2/44	KC6-31Z-01	GJH1213001R0311	3/16	LP185	1SFN074712R1000	5/257
HKF1-01	1SAM201901R1004	2/23	KC6-31Z-03	GJH1213001R0313	3/16	LP2050	1SFN076512R1000	5/257
HKF1-10	1SAM201901R1003	2/23	KC6-31Z-04	GJH1213001R0314	3/16	LP300	1SFN075112R1000	5/257
HKF1-11	1SAM201901R1001	2/23	KC6-31Z-05	GJH1213001R0315	3/16	LP460	1SFN075712R1000	5/257
HKF1-20	1SAM201901R1002	2/23	KC6-31Z-07	GJH1213001R0317	3/16	LP6	GJL1201907R0001	3/39
HKS4-02	1SAM401902R1003	2/44	KC6-31Z-1.4-81	GJH1213001R8311	3/17	LP750	1SFN076112R1000	5/257
HKS4-11	1SAM401902R1001	2/44	KC6-31Z-16	GJH1213001R1316	3/16	LT1000-EK	SK178001-MB	5/404
HKS4-20	1SAM401902R1002	2/44	KC6-31Z-2.4-51	GJH1213001R5311	3/17	LT140-30L	1SFN124203R1000	5/95
HTP500-BA4	1SNA235712R2400	4/82	KC6-31Z-F-01	GJH1213003R0311	3/37	LT140-40L	1SFN124203R2000	5/199
IB132-G	1SAM201911R1010	2/31	KC6-31Z-F-04	GJH1213003R0314	3/37	LT200/A	1SAZ401901R1001	7/24
IB132-Y	1SAM201911R1011	2/31	KC6-31Z-F-05	GJH1213003R0315	3/37	LT200E	1SAX501904R0001	7/36
K6-22Z-01	GJH1211001R0221	3/15	KC6-31Z-F-07	GJH1213003R0317	3/37	LT205-30C	1SFN124801R1000	5/95
K6-22Z-02	GJH1211001R0222	3/15	KC6-31Z-F-1.4-81	GJH1213003R8311	3/38	LT205-30L	1SFN124803R1000	5/95
K6-22Z-03	GJH1211001R0223	3/15	KC6-31Z-F-16	GJH1213003R1316	3/37	LT205-30Y	1SFN124804R1000	5/95
K6-22Z-80	GJH1211001R8220	3/15	KC6-31Z-F-51	GJH1213003R5311	3/38	LT205-40C	1SFN124801R2000	5/199
K6-22Z-84	GJH1211001R8224	3/15	KC6-31Z-P-01	GJH1213009R0311	3/26	LT205-40L	1SFN124803R2000	5/199
K6-22Z-85	GJH1211001R8225	3/15	KC6-31Z-P-04	GJH1213009R0314	3/26	LT320E	1SAX601904R0001	7/36
K6-22Z-F-01	GJH1211003R0221	3/36	KC6-31Z-P-05	GJH1213009R0315	3/26	LT370-30C	1SFN125401R1000	5/95
K6-22Z-F-02	GJH1211003R0222	3/36	KC6-31Z-P-1.4-81	GJH1213009R8311	3/28	LT370-30D	1SFN125406R1000	5/95
K6-22Z-F-03	GJH1211003R0223	3/36	KC6-31Z-P-16	GJH1213009R1316	3/26	LT370-30L	1SFN125403R1000	5/95
K6-22Z-F-80	GJH1211003R8220	3/36	KC6-31Z-P-2.4-51	GJH1213009R5311	3/28	LT370-30Y	1SFN125404R1000	5/95
K6-22Z-F-84	GJH1211003R8224	3/36	K6-40E-01	GJH1213001R0401	3/16	LT370-40C	1SFN125401R2000	5/199
K6-22Z-F-85	GJH1211003R8225	3/36	K6-40E-03	GJH1213001R0403	3/16	LT370-40L	1SFN125403R2000	5/199
K6-22Z-P-01	GJH1211009R0221	3/25	K6-40E-04	GJH1213001R0404	3/16	LT460-AC	1SFN125701R1000	5/107
K6-22Z-P-02	GJH1211009R0222	3/25	K6-40E-05	GJH1213001R0405	3/16	LT460-AL	1SFN125703R1000	5/107
K6-22Z-P-03	GJH1211009R0223	3/25	K6-40E-07	GJH1213001R0407	3/16	LT460EF	1SAX701904R0002	7/40
K6-22Z-P-80	GJH1211009R8220	3/25	K6-40E-1.4-81	GJH1213001R8401	3/17	LT52-40	1SBN123402R1000	5/363
K6-22Z-P-84	GJH1211009R8224	3/25	K6-40E-16	GJH1213001R1406	3/16	LT550-EK	SK178001-LB	5/404
K6-22Z-P-85	GJH1211009R8225	3/25	K6-40E-2.4-51	GJH1213001R5401	3/17	LT65-30	1SBN123401R1000	5/363
K6-31Z-01	GJH1211001R0311	3/15	K6-40E-F-01	GJH1213003R0401	3/37	LT6-B	GJL1201906R0001	3/39
K6-31Z-02	GJH1211001R0312	3/15	K6-40E-F-04	GJH1213003R0404	3/37	LT750-AC	1SFN126101R1000	5/107
K6-31Z-03	GJH1211001R0313	3/15	K6-40E-F-05	GJH1213003R0405	3/37	LT750-AL	1SFN126103R1000	5/107
K6-31Z-80	GJH1211001R8310	3/15	K6-40E-F-1.4-81	GJH1213003R8401	3/38	LT750EF	1SAX801904R0002	7/40
K6-31Z-84	GJH1211001R8314	3/15	K6-40E-F-16	GJH1213003R1406	3/37	LT80-40	1SBN123902R1000	5/363

Index

Type classification

Type	Order code	Page	Type	Order code	Page	Type	Order code	Page
LT96-30	1SBN123901R1000	5/363	MS132-0.16T	1SAM340000R1001	2/11	NF40E-13	1SBH137001R1340	5/318
LW110	1SFNO74307R1000	5/395	MS132-0.25	1SAM350000R1002	2/7	NF40E-14	1SBH137001R1440	5/318
LW1250	1SFNO76407R1000	5/107	MS132-0.25-HKF1-11	1SAM350005R1002	2/7	NF40E-41	1SBH137001R4140	5/318
LW140	1SFNO74207R1000	5/95	MS132-0.25T	1SAM340000R1002	2/11	NF40ES-12	1SBH137004R1240	6/68
LW205	1SFNO74807R1000	5/95	MS132-0.4	1SAM350000R1003	2/7	NF40ES-13	1SBH137004R1340	6/68
LW205-40	1SFNO74807R2000	5/199	MS132-0.4-HKF1-11	1SAM350005R1003	2/7	NF40ES-14	1SBH137004R1440	6/68
LW370	1SFNO75407R1000	5/95	MS132-0.4T	1SAM340000R1003	2/11	NF40ES-41	1SBH137004R4140	6/68
LW370-40	1SFNO75407R2000	5/199	MS132-0.63	1SAM350000R1004	2/7	NF44E-12	1SBH137001R1244	5/322
LW460	1SFNO75707R1000	5/107	MS132-0.63-HKF1-11	1SAM350005R1004	2/7	NF44E-13	1SBH137001R1344	5/322
LW750	1SFNO76107R1000	5/107	MS132-0.63T	1SAM340000R1004	2/11	NF44E-14	1SBH137001R1444	5/322
LX140	1SFNO74210R1000	5/95	MS132-1.0	1SAM350000R1005	2/7	NF44E-41	1SBH137001R4144	5/322
LX205	1SFNO74810R1000	5/95	MS132-1.0-HKF1-11	1SAM350005R1005	2/7	NF44ES-12	1SBH137004R1244	6/70
LX370	1SFNO75410R1000	5/95	MS132-1.0T	1SAM340000R1005	2/11	NF44ES-13	1SBH137004R1344	6/70
LX460	1SFNO75710R1000	5/107	MS132-1.6	1SAM350000R1006	2/7	NF44ES-14	1SBH137004R1444	6/70
LX750	1SFNO76110R1000	5/107	MS132-1.6-HKF1-11	1SAM350005R1006	2/7	NF44ES-41	1SBH137004R4144	6/70
LY140	1SFNO74203R1000	5/366	MS132-1.6T	1SAM340000R1006	2/11	NF51/11-12	1SBH137001R1259	5/322
LY16-4	1SBN071303T1000	5/366	MS132-10	1SAM350000R1010	2/7	NF51/11-13	1SBH137001R1359	5/322
LY185	1SFNO74703R1000	5/366	MS132-10.0-HKF1-11	1SAM350005R1010	2/7	NF51/11-14	1SBH137001R1459	5/322
LY300	1SFNO75103R1000	5/366	MS132-10T	1SAM340000R1010	2/11	NF51/11-41	1SBH137001R4159	5/322
LY38-4	1SBN072303T1000	5/366	MS132-12	1SAM350000R1012	2/7	NF53E-12	1SBH137001R1253	5/322
LY460	1SFNO75703R1000	5/366	MS132-12.0-HKF1-11	1SAM350005R1012	2/7	NF53E-13	1SBH137001R1353	5/322
LY750	1SFNO76103R1000	5/366	MS132-12T	1SAM340000R1012	2/11	NF53E-14	1SBH137001R1453	5/322
MO132-0.16	1SAM360000R1001	2/9	MS132-16	1SAM350000R1011	2/7	NF53E-41	1SBH137001R4153	5/322
MO132-0.25	1SAM360000R1002	2/9	MS132-16.0-HKF1-11	1SAM350005R1011	2/7	NF53ES-12	1SBH137004R1253	6/70
MO132-0.4	1SAM360000R1003	2/9	MS132-16T	1SAM340000R1011	2/11	NF53ES-13	1SBH137004R1353	6/70
MO132-0.63	1SAM360000R1004	2/9	MS132-2.5	1SAM350000R1007	2/7	NF53ES-14	1SBH137004R1453	6/70
MO132-1.0	1SAM360000R1005	2/9	MS132-2.5-HKF1-11	1SAM350005R1007	2/7	NF53ES-41	1SBH137004R4153	6/70
MO132-1.6	1SAM360000R1006	2/9	MS132-2.5T	1SAM340000R1007	2/11	NF62E-12	1SBH137001R1262	5/322
MO132-10	1SAM360000R1010	2/9	MS132-20	1SAM350000R1013	2/7	NF62E-13	1SBH137001R1362	5/322
MO132-12	1SAM360000R1012	2/9	MS132-20-HKF1-11	1SAM350005R1013	2/7	NF62E-14	1SBH137001R4162	5/322
MO132-16	1SAM360000R1011	2/9	MS132-20T	1SAM340000R1013	2/11	NF62E-41	1SBH137001R4162	5/322
MO132-2.5	1SAM360000R1007	2/9	MS132-25	1SAM350000R1014	2/7	NF62ES-12	1SBH137004R1262	6/70
MO132-20	1SAM360000R1013	2/9	MS132-25-HKF1-11	1SAM350005R1014	2/7	NF62ES-13	1SBH137004R1362	6/70
MO132-25	1SAM360000R1014	2/9	MS132-25T	1SAM340000R1014	2/11	NF62ES-14	1SBH137004R4162	6/70
MO132-32	1SAM360000R1015	2/9	MS132-32	1SAM350000R1015	2/7	NF62ES-41	1SBH137004R4162	6/70
MO132-4.0	1SAM360000R1008	2/9	MS132-32-HKF1-11	1SAM350005R1015	2/7	NF71E-12	1SBH137001R1271	5/322
MO132-6.3	1SAM360000R1009	2/9	MS132-4.0	1SAM350000R1008	2/7	NF71E-13	1SBH137001R1371	5/322
MO165-16	1SAM461000R1011	2/10	MS132-4.0-HKF1-11	1SAM350005R1008	2/7	NF71E-14	1SBH137001R4171	5/322
MO165-20	1SAM461000R1012	2/10	MS132-4.0T	1SAM340000R1008	2/11	NF71E-41	1SBH137001R4171	5/322
MO165-25	1SAM461000R1013	2/10	MS132-6.3	1SAM350000R1009	2/7	NF71ES-12	1SBH137004R1271	6/70
MO165-32	1SAM461000R1014	2/10	MS132-6.3-HKF1-11	1SAM350005R1009	2/7	NF71ES-13	1SBH137004R1371	6/70
MO165-42	1SAM461000R1015	2/10	MS132-6.3T	1SAM340000R1009	2/11	NF71ES-14	1SBH137004R4171	6/70
MO165-54	1SAM461000R1016	2/10	MS165-16	1SAM451000R1011	2/8	NF71ES-41	1SBH137004R4171	6/70
MO165-65	1SAM461000R1017	2/10	MS165-20	1SAM451000R1012	2/8	NF80E-12	1SBH137001R1280	5/322
MO495-100	1SAM560000R1010	2/37	MS165-25	1SAM451000R1013	2/8	NF80E-13	1SBH137001R1380	5/322
MO495-63	1SAM560000R1007	2/37	MS165-32	1SAM451000R1014	2/8	NF80E-14	1SBH137001R1480	5/322
MO495-75	1SAM560000R1008	2/37	MS165-42	1SAM451000R1015	2/8	NF80E-41	1SBH137001R4180	5/322
MO495-90	1SAM560000R1009	2/37	MS165-54	1SAM451000R1016	2/8	NF80ES-12	1SBH137004R1280	6/70
MO496-100	1SAM590000R1010	2/37	MS165-65	1SAM451000R1017	2/8	NF80ES-13	1SBH137004R1380	6/70
MO496-32	1SAM590000R1004	2/37	MS495-100	1SAM550000R1010	2/32	NF80ES-14	1SBH137004R1480	6/70
MO496-40	1SAM590000R1005	2/37	MS495-63	1SAM550000R1007	2/32	NF80ES-41	1SBH137004R4180	6/70
MO496-50	1SAM590000R1006	2/37	MS495-75	1SAM550000R1008	2/32	NFZ22E-20	1SBH136001R2022	5/319
MO496-63	1SAM590000R1007	2/37	MS495-90	1SAM550000R1009	2/32	NFZ22E-21	1SBH136001R2122	5/319
MO496-75	1SAM590000R1008	2/37	MS497-100	1SAM580000R1010	2/32	NFZ22E-22	1SBH136001R2222	5/319
MO496-90	1SAM590000R1009	2/37	MS497-32	1SAM580000R1004	2/32	NFZ22E-23	1SBH136001R2322	5/319
MOS100-100	1SDA082033R1	2/37	MS497-40	1SAM580000R1005	2/32	NFZ22ES-20	1SBH136004R2022	6/69
MOS100-70	1SDA082031R1	2/37	MS497-50	1SAM580000R1006	2/32	NFZ22ES-21	1SBH136004R2122	6/69
MOS100-80	1SDA082032R1	2/37	MS497-63	1SAM580000R1007	2/32	NFZ22ES-22	1SBH136004R2222	6/69
MS116-0.16	1SAM250000R1001	2/6	MS497-75	1SAM580000R1008	2/32	NFZ22ES-23	1SBH136004R2322	6/69
MS116-0.16-HKF1-11	1SAM250005R1001	2/6	MS497-90	1SAM580000R1009	2/32	NFZ31E-20	1SBH136001R2031	5/319
MS116-0.25	1SAM250000R1002	2/6	MS5100-100	1SDA082034R1	2/32	NFZ31E-21	1SBH136001R2131	5/319
MS116-0.25-HKF1-11	1SAM250005R1002	2/6	MSAH1	1SAM201909R1021	2/47	NFZ31E-22	1SBH136001R2231	5/319
MS116-0.4	1SAM250000R1003	2/6	MSH-AR	1SAM201920R1000	2/47	NFZ31E-23	1SBH136001R2331	5/319
MS116-0.4-HKF1-11	1SAM250005R1003	2/6	MSH-LB	1SAM201920R1001	2/47	NFZ31ES-20	1SBH136004R2031	6/69
MS116-0.63	1SAM250000R1004	2/6	MSH-LTB	1SAM201920R1011	2/47	NFZ31ES-21	1SBH136004R2131	6/69
MS116-0.63-HKF1-11	1SAM250005R1004	2/6	MSH-LTY	1SAM201920R1012	2/47	NFZ31ES-22	1SBH136004R2231	6/69
MS116-1.0	1SAM250000R1005	2/6	MSH-LY	1SAM201920R1002	2/47	NFZ31ES-23	1SBH136004R2331	6/69
MS116-1.0-HKF1-11	1SAM250005R1005	2/6	MSMN	1SAM101923R0002	2/47	NFZ33/11-20	1SBH136001R2039	5/323
MS116-1.6	1SAM250000R1006	2/6	MSMNO	1SAM101923R0012	2/47	NFZ33/11-21	1SBH136001R2139	5/323
MS116-1.6-HKF1-11	1SAM250005R1006	2/6	NF22E-12	1SBH137001R1222	5/318	NFZ33/11-22	1SBH136001R2239	5/323
MS116-10	1SAM250000R1010	2/6	NF22E-13	1SBH137001R1322	5/318	NFZ33/11-23	1SBH136001R2339	5/323
MS116-10.0-HKF1-11	1SAM250005R1010	2/6	NF22E-14	1SBH137001R1422	5/318	NFZ40E-20	1SBH136001R2040	5/319
MS116-12	1SAM250000R1012	2/6	NF22E-41	1SBH137001R4122	5/318	NFZ40E-21	1SBH136001R2140	5/319
MS116-12.0-HKF1-11	1SAM250005R1012	2/6	NF22ES-12	1SBH137004R1222	6/68	NFZ40E-22	1SBH136001R2240	5/319
MS116-16	1SAM250000R1011	2/6	NF22ES-13	1SBH137004R1322	6/68	NFZ40E-23	1SBH136001R2340	5/319
MS116-16.0-HKF1-11	1SAM250005R1011	2/6	NF22ES-14	1SBH137004R1422	6/68	NFZ40ES-20	1SBH136004R2040	6/69
MS116-2.5	1SAM250000R1007	2/6	NF22ES-41	1SBH137004R4122	6/68	NFZ40ES-21	1SBH136004R2140	6/69
MS116-2.5-HKF1-11	1SAM250005R1007	2/6	NF31E-12	1SBH137001R1231	5/318	NFZ40ES-22	1SBH136004R2240	6/69
MS116-20	1SAM250000R1013	2/6	NF31E-13	1SBH137001R1331	5/318	NFZ40ES-23	1SBH136004R2340	6/69
MS116-20-HKF1-11	1SAM250005R1013	2/6	NF31E-14	1SBH137001R1431	5/318	NFZ44E-20	1SBH136001R2044	5/323
MS116-25	1SAM250000R1014	2/6	NF31E-41	1SBH137001R4131	5/318	NFZ44E-21	1SBH136001R2144	5/323
MS116-25-HKF1-11	1SAM250005R1014	2/6	NF31ES-12	1SBH137004R1231	6/68	NFZ44E-22	1SBH136001R2244	5/323
MS116-32	1SAM250000R1015	2/6	NF31ES-13	1SBH137004R1331	6/68	NFZ44E-23	1SBH136001R2344	5/323
MS116-32-HKF1-11	1SAM250005R1015	2/6	NF31ES-14	1SBH137004R1431	6/68	NFZ44ES-20	1SBH136004R2044	6/71
MS116-4.0	1SAM250000R1008	2/6	NF31ES-41	1SBH137004R4131	6/68	NFZ44ES-21	1SBH136004R2144	6/71
MS116-4.0-HKF1-11	1SAM250005R1008	2/6	NF33/11-12	1SBH137001R1239	5/322	NFZ44ES-22	1SBH136004R2244	6/71
MS116-6.3	1SAM250000R1009	2/6	NF33/11-13	1SBH137001R1339	5/322	NFZ44ES-23	1SBH136004R2344	6/71
MS116-6.3-HKF1-11	1SAM250005R1009	2/6	NF33/11-14	1SBH137001R1439	5/322	NFZ51/11-20	1SBH136001R2059	5/323
MS132-0.16	1SAM350000R1001	2/7	NF33/11-41	1SBH137001R4139	5/322	NFZ51/11-21	1SBH136001R2159	5/323
MS132-0.16-HKF1-11	1SAM350005R1001	2/7	NF40E-12	1SBH137001R1240	5/318	NFZ51/11-22	1SBH136001R2259	5/323

Index

Type classification

Type	Order code	Page	Type	Order code	Page	Type	Order code	Page
NFZ51/11-23	1SBH136001R2359	5/323	PN750-11	1SFN096105R1000	5/370	SOR-C 48-60V AC/DC	1SDA066323R1	2/42
NFZ53E-20	1SBH136001R2053	5/323	PN750-21	1SFN096101R1000	5/370	SPRC 1	1SNA360010R1500	4/82
NFZ53E-21	1SBH136001R2153	5/323	PN750-41	1SFN096103R1000	5/370	T16-0.13	1SAZ711201R1005	4/20
NFZ53E-22	1SBH136001R2253	5/323	PR146-1	1SFN094200R1000	5/371	T16-0.17	1SAZ711201R1008	4/20
NFZ53E-23	1SBH136001R2353	5/323	PR185-2	1SFN095100R1001	5/371	T16-0.23	1SAZ711201R1009	4/20
NFZ53ES-20	1SBH136004R2053	6/71	PR210-1	1SFN094900R1000	5/371	T16-0.31	1SAZ711201R1013	4/20
NFZ53ES-21	1SBH136004R2153	6/71	PR300-1	1SFN095300R1000	5/371	T16-0.41	1SAZ711201R1014	4/20
NFZ53ES-22	1SBH136004R2253	6/71	PR300-2	1SFN095300R1001	5/371	T16-0.55	1SAZ711201R1017	4/20
NFZ53ES-23	1SBH136004R2353	6/71	PR400-2	1SFN095700R1002	5/371	T16-0.74	1SAZ711201R1021	4/20
NFZ62E-20	1SBH136001R2062	5/323	PR460-1	1SFN095700R1000	5/371	T16-1.0	1SAZ711201R1023	4/20
NFZ62E-21	1SBH136001R2162	5/323	PR460-2	1SFN095700R1001	5/371	T16-1.3	1SAZ711201R1025	4/20
NFZ62E-22	1SBH136001R2262	5/323	PR580-2	1SFN096100R1002	5/371	T16-1.7	1SAZ711201R1028	4/20
NFZ62E-23	1SBH136001R2362	5/323	PR750-1	1SFN096100R1000	5/371	T16-10	1SAZ711201R1043	4/20
NFZ62ES-20	1SBH136004R2062	6/71	PR750-2	1SFN096100R1001	5/371	T16-13	1SAZ711201R1045	4/20
NFZ62ES-21	1SBH136004R2162	6/71	PS1-2-0-65	1SAM201906R1102	2/28	T16-16	1SAZ711201R1047	4/20
NFZ62ES-22	1SBH136004R2262	6/71	PS1-2-1-65	1SAM201906R1112	2/28	T16-2.3	1SAZ711201R1031	4/20
NFZ62ES-23	1SBH136004R2362	6/71	PS1-2-2-65	1SAM201906R1122	2/28	T16-3.1	1SAZ711201R1033	4/20
NFZ71E-20	1SBH136001R2071	5/323	PS1-3-0-100	1SAM201916R1103	2/28	T16-4.2	1SAZ711201R1035	4/20
NFZ71E-21	1SBH136001R2171	5/323	PS1-3-0-65	1SAM201906R1103	2/28	T16-5.7	1SAZ711201R1038	4/20
NFZ71E-22	1SBH136001R2271	5/323	PS1-3-1-100	1SAM201916R1113	2/28	T16-7.6	1SAZ711201R1040	4/20
NFZ71E-23	1SBH136001R2371	5/323	PS1-3-1-65	1SAM201906R1113	2/28	T4S 250 PR222MP In200	1SDA054527R1	5/20
NFZ71ES-20	1SBH136004R2071	6/71	PS1-3-2-100	1SAM201916R1123	2/28	T4S 320 PR221-I In320	1SDA054126R1	5/22
NFZ71ES-21	1SBH136004R2171	6/71	PS1-3-2-65	1SAM201906R1123	2/28	T5S 400 PR221-I In400	1SDA054335R1	5/22
NFZ71ES-22	1SBH136004R2271	6/71	PS1-4-0-100	1SAM201916R1104	2/28	T5S 400 PR222MP In320	1SDA054553R1	5/20
NFZ71ES-23	1SBH136004R2371	6/71	PS1-4-0-65	1SAM201906R1104	2/28	T5S 400 PR222MP In400	1SDA054554R1	5/20
NFZ80E-20	1SBH136001R2080	5/323	PS1-4-1-100	1SAM201916R1114	2/28	T5S 630 PR221-I In630	1SDA054405R1	5/22
NFZ80E-21	1SBH136001R2180	5/323	PS1-4-1-65	1SAM201906R1114	2/28	TA200DU-110	1SAZ421201R1002	7/24
NFZ80E-22	1SBH136001R2280	5/323	PS1-4-2-65	1SAM201906R1124	2/28	TA200DU-110-V1000	1SAZ421301R1002	7/24
NFZ80E-23	1SBH136001R2380	5/323	PS1-5-0-100	1SAM201916R1105	2/28	TA200DU-135	1SAZ421201R1003	7/24
NFZ80ES-20	1SBH136004R2080	6/71	PS1-5-0-65	1SAM201906R1105	2/28	TA200DU-135-V1000	1SAZ421301R1003	7/24
NFZ80ES-21	1SBH136004R2180	6/71	PS1-5-1-100	1SAM201916R1115	2/28	TA200DU-150	1SAZ421201R1004	7/24
NFZ80ES-22	1SBH136004R2280	6/71	PS1-5-1-65	1SAM201906R1115	2/28	TA200DU-150-V1000	1SAZ421301R1004	7/24
NFZ80ES-23	1SBH136004R2380	6/71	PS1-5-2-65	1SAM201906R1125	2/28	TA200DU-175	1SAZ421201R1005	5/22
NS22E-20	1SBH101001R2022	4/62	PS2-2-0-125	1SAM401920R1002	2/29	TA200DU-175-V1000	1SAZ421301R1005	7/24
NS22E-26	1SBH101001R2622	4/62	PS2-2-2-125	1SAM401920R1022	2/29	TA200DU-200	1SAZ421201R1006	5/22
NS22ES-20	1SBH101004R2022	6/22	PS2-3-0-125	1SAM401920R1003	2/29	TA200DU-200-V1000	1SAZ421301R1006	7/24
NS22ES-26	1SBH101004R2622	6/22	PS2-3-2-125	1SAM401920R1023	2/29	TA200DU-90	1SAZ421201R1001	7/24
NS31E-20	1SBH101001R2031	4/62	PS2-4-0-125	1SAM401920R1004	2/29	TA200DU-90-V1000	1SAZ421301R1001	7/24
NS31E-26	1SBH101001R2631	4/62	PS2-4-2-125	1SAM401920R1024	2/29	TBC7-22-00-55	GJL1313561R5005	3/14
NS31ES-20	1SBH101004R2031	6/22	RA4	1SBN060100R1000	5/356	TBC7-22-00-62	GJL1313561R6002	3/14
NS31ES-26	1SBH101004R2631	6/22	RA4-T	1SBN060100T1000	5/356	TBC7-22-00-68	GJL1313561R6008	3/14
NS40E-20	1SBH101001R2040	4/62	RA5-1	1SBN060300R1000	5/391	TBC7-30-01-51	GJL1313061R5011	3/11
NS40E-26	1SBH101001R2640	4/62	RC5	1SBN060300T1000	5/391	TBC7-30-01-55	GJL1313061R5015	3/11
NS40ES-20	1SBH101004R2040	6/22	RC5-1/133	1SBN050100R1001	4/37	TBC7-30-01-62	GJL1313061R6012	3/11
NS40ES-26	1SBH101004R2640	6/22	RC5-1/250	1SBN050100R1002	4/37	TBC7-30-01-68	GJL1313061R6018	3/11
NS44E-20	1SBH101001R2044	4/62	RC5-1/440	1SBN050100R1003	4/37	TBC7-30-10-51	GJL1313061R5011	3/11
NS44E-26	1SBH101001R2644	4/62	RC5-1/500	1SBN050100R1000	4/37	TBC7-30-10-55	GJL1313061R5015	3/11
NS44ES-20	1SBH101004R2044	6/22	RC5-2/133	1SBN050200R1001	5/389	TBC7-30-10-62	GJL1313061R6012	3/11
NS44ES-26	1SBH101004R2644	6/22	RC5-2/250	1SBN050200R1002	5/389	TBC7-30-10-68	GJL1313061R6018	3/11
NS53E-20	1SBH101001R2053	4/62	RC5-2/440	1SBN050200R1003	5/389	TBC7-31-00-55	GJL1313461R5005	3/14
NS53E-26	1SBH101001R2653	4/62	RC5-2/500	1SBN050200R1000	5/389	TBC7-31-00-62	GJL1313461R6002	3/14
NS53ES-20	1SBH101004R2053	6/22	RC-EH800/110	SK829007-C	5/213	TBC7-31-00-68	GJL1313461R6008	3/14
NS53ES-26	1SBH101004R2653	6/22	RC-EH800/600	SK829007-D	5/213	TEF3-OFF	1SBN0201014R1000	4/37
NS62E-20	1SBH101001R2062	4/62	RHD Normal Direct Handle	1SDA066475R1	2/47	TEF3-ON	1SBN021012R1000	4/37
NS62E-26	1SBH101001R2662	4/62	RT5/150	1SDA069053R1	2/47	TEF4-OFF	1SBN020114R1000	5/89
NS62ES-20	1SBH101004R2062	6/22	RT5/264	1SBN050020R1003	4/37	TEF4-ON	1SBN020112R1000	5/89
NS62ES-26	1SBH101004R2662	6/22	RT5/32	1SBN050020R1004	4/37	TEF4S-OFF	1SBN020115R1000	6/51
NS71E-20	1SBH101001R2071	4/62	RT5/65	1SBN050020R1000	4/37	TEF4S-ON	1SBN020113R1000	6/51
NS71E-26	1SBH101001R2671	4/62	RT5/90	1SBN050020R1001	4/37	TEF5-OFF	1SBN020314R1000	5/382
NS71ES-20	1SBH101004R2071	6/22	RU19/120	1SBN050020R1002	4/37	TEF5-ON	1SBN020312R1000	5/382
NS71ES-26	1SBH101004R2671	6/22	RU19/240	1SFN170801R1001	5/372	TF140DU-110	1SAZ431201R1002	5/22
NS80E-20	1SBH101001R2080	4/62	RV5/133	1SFN170801R1002	5/372	TF140DU-110-V1000	1SAZ431301R1002	7/20
NS80E-26	1SBH101001R2680	4/62	RV5/250	1SBN050010R1001	4/37	TF140DU-135	1SAZ431201R1003	5/36
NS80ES-20	1SBH101004R2080	6/22	RV5/440	1SBN050010R1002	4/37	TF140DU-135-V1000	1SAZ431301R1003	7/20
NS80ES-26	1SBH101004R2680	6/22	RV5/50	1SBN050010R1003	4/37	TF140DU-142	1SAZ431201R1004	5/22
NSL22E-81	1SBH103001R8122	4/63	RV5/60	1SBN050010R1000	4/37	TF140DU-142-V1000	1SAZ431301R1004	7/20
NSL22ES-81	1SBH103004R8122	6/23	RV-BC6/250	GHV2501903R0002	3/39	TF140DU-90	1SAZ431201R1001	7/20
NSL31E-81	1SBH103001R8131	4/63	RV-BC6/380	GHV2501904R0002	3/39	TF140DU-90-V1000	1SAZ431301R1001	7/20
NSL31ES-81	1SBH103004R8131	6/23	RV-BC6/60	GHV2501902R0002	3/39	TF42-0.13	1SAZ721201R1005	7/8
NSL40E-81	1SBH103001R8140	4/63	RV-BC6-F/250	GHV2501903R0003	3/39	TF42-0.17	1SAZ721201R1008	7/8
NSL40ES-81	1SBH103004R8140	6/23	RV-BC6-F/380	GHV2501904R0003	3/39	TF42-0.23	1SAZ721201R1009	7/8
NSL44E-81	1SBH103001R8144	4/63	RV-BC6-F/60	GHV2501902R0003	3/39	TF42-0.31	1SAZ721201R1013	7/8
NSL44ES-81	1SBH103004R8144	6/23	S1-M1-25	1SAM201907R1101	2/28	TF42-0.41	1SAZ721201R1014	7/8
NSL53E-81	1SBH103001R8153	4/63	S1-M2-25	1SAM201907R1102	2/28	TF42-0.55	1SAZ721201R1017	7/8
NSL53ES-81	1SBH103004R8153	6/23	S1-M3-25	1SAM201907R1103	2/28	TF42-0.74	1SAZ721201R1021	7/8
NSL62E-81	1SBH103001R8162	4/63	S1-M3-35	1SAM201913R1103	2/28	TF42-1.0	1SAZ721201R1023	7/8
NSL62ES-81	1SBH103004R8162	6/23	S1-PB1-25	1SAM201914R1002	2/28	TF42-1.3	1SAZ721201R1025	7/8
NSL71E-81	1SBH103001R8171	4/63	SA1	GJF1101903R0001	2/28	TF42-1.7	1SAZ721201R1028	7/8
NSL71ES-81	1SBH103004R8171	6/23	SA2	GJF1101903R0002	2/28	TF42-10	1SAZ721201R1043	5/36
NSL80E-81	1SBH103001R8180	4/63	SA3	GJF1101903R0003	2/28	TF42-13	1SAZ721201R1045	5/36
NSL80ES-81	1SBH103004R8180	6/23	SK1-02	1SAM201903R1003	2/23	TF42-16	1SAZ721201R1047	5/36
OESA460H/OESA400	1SFN085709R1000	5/369	SK1-11	1SAM201903R1001	2/23	TF42-2.3	1SAZ721201R1031	7/8
OXS6X105	1SCA108043R1001	2/47	SK1-20	1SAM201903R1002	2/23	TF42-20	1SAZ721201R1049	5/60
OXS6X130	1SCA101655R1001	2/47	SK4-11	1SAM401904R1001	2/44	TF42-24	1SAZ721201R1051	5/36
OXS6X180	1SCA101659R1001	2/47	SOR-C 110-127V AC / 110-125V DC	1SDA066324R1	2/42	TF42-29	1SAZ721201R1052	5/60
OXS6X85	1SCA101647R1001	2/47	SOR-C 12V DC	1SDA066321R1	2/42	TF42-3.1	1SAZ721201R1033	7/8
PB1-1-32	1SAM201914R1001	2/28	SOR-C 220-240V AC / 220-250V DC	1SDA066325R1	2/42	TF42-35	1SAZ721201R1053	5/36
PN460-11	1SFN095705R1000	5/370	SOR-C 24-30V AC/DC	1SDA066322R1	2/42	TF42-38	1SAZ721201R1055	5/36
PN460-21	1SFN095701R1000	5/370	SOR-C 380-440V AC	1SDA066326R1	2/42	TF42-4.2	1SAZ721201R1035	7/8
PN460-41	1SFN095703R1000	5/370	SOR-C 480-525V AC	1SDA066327R1	2/42	TF42-5.7	1SAZ721201R1038	7/8

Index

Type classification

Type	Order code	Page	Type	Order code	Page	Type	Order code	Page
TF42-7.6	1SAZ721201R1040	7/8		1SBL281022R8610	5/285		1SFL431024R8600	5/278
TF65-28	1SAZ811201R1001	7/12		1SBL281022R8810	5/285		1SFL431024R8800	5/278
TF65-33	1SAZ811201R1002	7/12	UA30-30-10RA	1SBL281024R8010	5/276	UA95-30-11	1SFL431022R8011	5/289
TF65-40	1SAZ811201R1003	5/36		1SBL281024R8110	5/276		1SFL431022R8111	5/289
TF65-47	1SAZ811201R1004	5/36		1SBL281024R8310	5/276		1SFL431022R8311	5/289
TF65-53	1SAZ811201R1005	7/12		1SBL281024R8410	5/276		1SFL431022R8411	5/289
TF65-60	1SAZ811201R1006	5/36		1SBL281024R8510	5/276		1SFL431022R8511	5/289
TF65-67	1SAZ811201R1007	7/12		1SBL281024R8610	5/276		1SFL431022R8611	5/289
TF96-51	1SAZ911201R1001	7/16		1SBL281024R8810	5/276		1SFL431022R8811	5/289
TF96-60	1SAZ911201R1002	7/16	UA4-110	1SAM401905R1001	2/44	UVR-C 110-127V AC / 110-125V DC	1SDA066398R1	2/42
TF96-68	1SAZ911201R1003	5/36	UA4-230	1SAM401905R1002	2/44	UVR-C 220-240V AC / 220-250V DC	1SDA066399R1	2/42
TF96-78	1SAZ911201R1004	5/60	UA4-24	1SAM401905R1004	2/44	UVR-C 24-30V AC/DC	1SDA066396R1	2/42
TF96-87	1SAZ911201R1005	5/36	UA4-400	1SAM401905R1003	2/44	UVR-C 380-440V AC	1SDA066400R1	2/42
TF96-96	1SAZ911201R1006	5/60	UA4-HK-230	1SAM401906R1001	2/44	UVR-C 480-525V AC	1SDA066401R1	2/42
TKC6-22Z-51	GJH1213061R5221	3/18	UA4-HK-400	1SAM401906R1002	2/44	UVR-C 48V AC/DC	1SDA060965R1	2/42
TKC6-22Z-55	GJH1213061R5225	3/18	UA50-30-00	1SBL351022R8000	5/286	UVR-C 60V AC/DC	1SDA066397R1	2/42
TKC6-22Z-62	GJH1213061R6222	3/18		1SBL351022R8100	5/286	VAS09EM-20M	1SBK103600M2000	4/46
TKC6-22Z-68	GJH1213061R6228	3/18		1SBL351022R8300	5/286	VAS09EM-26M	1SBK103600M2600	4/46
TKC6-31Z-51	GJH1213061R5311	3/18		1SBL351022R8400	5/286	VAS09SEM-20M	1SBK103800M2000	4/46
TKC6-31Z-55	GJH1213061R5315	3/18		1SBL351022R8500	5/286	VAS09SEM-26M	1SBK103800M2600	4/46
TKC6-31Z-62	GJH1213061R6312	3/18		1SBL351022R8600	5/286	VAS12EM-20M	1SBK113600M2000	4/46
TKC6-31Z-68	GJH1213061R6318	3/18		1SBL351022R8800	5/286	VAS12EM-26M	1SBK113600M2600	4/46
TKC6-40E-51	GJH1213061R5401	3/18	UA50-30-00RA	1SBL351024R8000	5/277	VAS12SEM-20M	1SBK113800M2000	4/46
TKC6-40E-55	GJH1213061R5405	3/18		1SBL351024R8100	5/277	VAS12SEM-26M	1SBK113800M2600	4/46
TKC6-40E-62	GJH1213061R6402	3/18		1SBL351024R8300	5/277	VAS16EM-20M	1SBK123600M2000	4/46
TKC6-40E-68	GJH1213061R6408	3/18		1SBL351024R8400	5/277	VAS16EM-26M	1SBK123600M2600	4/46
UA110-30-00	1SFL451022R8000	5/288		1SBL351024R8500	5/277	VAS16SEM-20M	1SBK123800M2000	4/46
	1SFL451022R8100	5/288		1SBL351024R8600	5/277	VAS16SEM-26M	1SBK123800M2600	4/46
	1SFL451022R8300	5/288		1SBL351024R8800	5/277	VASL09EM-81M	1SBK103700M8100	4/47
	1SFL451022R8400	5/288	UA50-30-11	1SBL351022R8011	5/287	VASL09SEM-81M	1SBK103900M8100	4/47
	1SFL451022R8500	5/288		1SBL351022R8111	5/287	VASL12EM-81M	1SBK113700M8100	4/47
	1SFL451022R8600	5/288		1SBL351022R8311	5/287	VASL12SEM-81M	1SBK113900M8100	4/47
	1SFL451022R8800	5/288		1SBL351022R8411	5/287	VASL16EM-81M	1SBK123700M8100	4/47
UA110-30-00RA	1SFL451024R8000	5/278		1SBL351022R8511	5/287	VASL16SEM-81M	1SBK123900M8100	4/47
	1SFL451024R8100	5/278		1SBL351022R8611	5/287	VB6-30-01-01	GJL1211901R0011	3/6
	1SFL451024R8300	5/278		1SBL351022R8811	5/287	VB6-30-01-02	GJL1211901R0012	3/6
	1SFL451024R8400	5/278	UA63-30-00	1SBL371022R8000	5/286	VB6-30-01-03	GJL1211901R0013	3/6
	1SFL451024R8500	5/278		1SBL371022R8100	5/286	VB6-30-01-80	GJL1211901R8010	3/6
	1SFL451024R8600	5/278		1SBL371022R8300	5/286	VB6-30-01-84	GJL1211901R8014	3/6
	1SFL451024R8800	5/278		1SBL371022R8400	5/286	VB6-30-01-85	GJL1211901R8015	3/6
UA110-30-11	1SFL451022R8011	5/289		1SBL371022R8500	5/286	VB6-30-01-P-01	GJL1211909R0011	3/21
	1SFL451022R8111	5/289		1SBL371022R8600	5/286	VB6-30-01-P-02	GJL1211909R0012	3/21
	1SFL451022R8311	5/289		1SBL371022R8800	5/286	VB6-30-01-P-03	GJL1211909R0013	3/21
	1SFL451022R8411	5/289	UA63-30-00RA	1SBL371024R8000	5/277	VB6-30-01-P-80	GJL1211909R8010	3/21
	1SFL451022R8511	5/289		1SBL371024R8100	5/277	VB6-30-01-P-84	GJL1211909R8014	3/21
	1SFL451022R8611	5/289		1SBL371024R8300	5/277	VB6-30-01-P-85	GJL1211909R8015	3/21
	1SFL451022R8811	5/289		1SBL371024R8400	5/277	VB6-30-10-01	GJL1211901R0101	3/6
UA1-110	1SAM201904R1004	2/24		1SBL371024R8500	5/277	VB6-30-10-02	GJL1211901R0102	3/6
UA1-20	1SAM201904R1010	2/24		1SBL371024R8600	5/277	VB6-30-10-03	GJL1211901R0103	3/6
UA1-208	1SAM201904R1008	2/24		1SBL371024R8800	5/277	VB6-30-10-80	GJL1211901R8100	3/6
UA1-230	1SAM201904R1005	2/24	UA63-30-11	1SBL371022R8011	5/287	VB6-30-10-84	GJL1211901R8104	3/6
UA1-24	1SAM201904R1001	2/24		1SBL371022R8111	5/287	VB6-30-10-85	GJL1211901R8105	3/6
UA1-400	1SAM201904R1006	2/24		1SBL371022R8311	5/287	VB6-30-10-P-01	GJL1211909R0101	3/21
UA1-415	1SAM201904R1007	2/24		1SBL371022R8411	5/287	VB6-30-10-P-02	GJL1211909R0102	3/21
UA1-48	1SAM201904R1002	2/24		1SBL371022R8511	5/287	VB6-30-10-P-03	GJL1211909R0103	3/21
UA1-575	1SAM201904R1009	2/24		1SBL371022R8611	5/287	VB6-30-10-P-80	GJL1211909R8100	3/21
UA1-60	1SAM201904R1003	2/24		1SBL371022R8811	5/287	VB6-30-10-P-84	GJL1211909R8104	3/21
UA16-30-10	1SBL181022R8010	5/285	UA75-30-00	1SBL411022R8000	5/286	VB6-30-10-P-85	GJL1211909R8105	3/21
	1SBL181022R8110	5/285		1SBL411022R8100	5/286	VB6A-30-01-01	GJL1211911R0011	3/8
	1SBL181022R8310	5/285		1SBL411022R8300	5/286	VB6A-30-01-02	GJL1211911R0012	3/8
	1SBL181022R8410	5/285		1SBL411022R8400	5/286	VB6A-30-01-03	GJL1211911R0013	3/8
	1SBL181022R8510	5/285		1SBL411022R8500	5/286	VB6A-30-01-80	GJL1211911R8010	3/8
	1SBL181022R8610	5/285		1SBL411022R8600	5/286	VB6A-30-01-84	GJL1211911R8014	3/8
	1SBL181022R8810	5/285		1SBL411022R8800	5/286	VB6A-30-01-85	GJL1211911R8015	3/8
UA16-30-10RA	1SBL181024R8010	5/276	UA75-30-00RA	1SBL411024R8000	5/277	VB6A-30-01-P-01	GJL1211919R0011	3/23
	1SBL181024R8110	5/276		1SBL411024R8100	5/277	VB6A-30-01-P-02	GJL1211919R0012	3/23
	1SBL181024R8310	5/276		1SBL411024R8300	5/277	VB6A-30-01-P-03	GJL1211919R0013	3/23
	1SBL181024R8410	5/276		1SBL411024R8400	5/277	VB6A-30-01-P-80	GJL1211919R8010	3/23
	1SBL181024R8510	5/276		1SBL411024R8500	5/277	VB6A-30-01-P-84	GJL1211919R8014	3/23
	1SBL181024R8610	5/276		1SBL411024R8600	5/277	VB6A-30-01-P-85	GJL1211919R8015	3/23
	1SBL181024R8810	5/276		1SBL411024R8800	5/277	VB6A-30-10-01	GJL1211911R0101	3/8
UA26-30-10	1SBL241022R8010	5/285	UA75-30-11	1SBL411022R8011	5/287	VB6A-30-10-02	GJL1211911R0102	3/8
	1SBL241022R8110	5/285		1SBL411022R8111	5/287	VB6A-30-10-03	GJL1211911R0103	3/8
	1SBL241022R8310	5/285		1SBL411022R8311	5/287	VB6A-30-10-80	GJL1211911R8100	3/8
	1SBL241022R8410	5/285		1SBL411022R8411	5/287	VB6A-30-10-84	GJL1211911R8104	3/8
	1SBL241022R8510	5/285		1SBL411022R8511	5/287	VB6A-30-10-85	GJL1211911R8105	3/8
	1SBL241022R8610	5/285		1SBL411022R8611	5/287	VB6A-30-10-P-01	GJL1211919R0101	3/23
	1SBL241022R8810	5/285		1SBL411022R8811	5/287	VB6A-30-10-P-02	GJL1211919R0102	3/23
UA26-30-10RA	1SBL241024R8010	5/276	UA95-30-00	1SFL431022R8000	5/288	VB6A-30-10-P-03	GJL1211919R0103	3/23
	1SBL241024R8110	5/276		1SFL431022R8100	5/288	VB6A-30-10-P-80	GJL1211919R8100	3/23
	1SBL241024R8310	5/276		1SFL431022R8300	5/288	VB6A-30-10-P-84	GJL1211919R8104	3/23
	1SBL241024R8410	5/276		1SFL431022R8400	5/288	VB6A-30-10-P-85	GJL1211919R8105	3/23
	1SBL241024R8510	5/276		1SFL431022R8500	5/288	VB7-30-01-01	GJL1311901R0011	3/6
	1SBL241024R8610	5/276		1SFL431022R8600	5/288	VB7-30-01-02	GJL1311901R0012	3/6
	1SBL241024R8810	5/276		1SFL431022R8800	5/288	VB7-30-01-03	GJL1311901R0013	3/6
UA30-30-10	1SBL281022R8010	5/285	UA95-30-00RA	1SFL431024R8000	5/278	VB7-30-01-80	GJL1311901R8010	3/6
	1SBL281022R8110	5/285		1SFL431024R8100	5/278	VB7-30-01-84	GJL1311901R8014	3/6
	1SBL281022R8310	5/285		1SFL431024R8300	5/278	VB7-30-01-85	GJL1311901R8015	3/6
	1SBL281022R8410	5/285		1SFL431024R8400	5/278	VB7-30-01-F-01	GJL1311903R0011	3/31
	1SBL281022R8510	5/285		1SFL431024R8500	5/278	VB7-30-01-F-02	GJL1311903R0012	3/31

Index

Type classification

Type	Order code	Page
VB7-30-01-F-03	GJL1311903R0013	3/31
VB7-30-01-F-80	GJL1311903R8010	3/31
VB7-30-01-F-84	GJL1311903R8014	3/31
VB7-30-01-F-85	GJL1311903R8015	3/31
VB7-30-01-P-01	GJL1311909R0011	3/21
VB7-30-01-P-02	GJL1311909R0012	3/21
VB7-30-01-P-03	GJL1311909R0013	3/21
VB7-30-01-P-80	GJL1311909R8010	3/21
VB7-30-01-P-84	GJL1311909R8014	3/21
VB7-30-01-P-85	GJL1311909R8015	3/21
VB7-30-10-01	GJL1311901R0101	3/6
VB7-30-10-02	GJL1311901R0102	3/6
VB7-30-10-03	GJL1311901R0103	3/6
VB7-30-10-80	GJL1311901R8100	3/6
VB7-30-10-84	GJL1311901R8104	3/6
VB7-30-10-85	GJL1311901R8105	3/6
VB7-30-10-F-01	GJL1311903R0101	3/31
VB7-30-10-F-02	GJL1311903R0102	3/31
VB7-30-10-F-03	GJL1311903R0103	3/31
VB7-30-10-F-80	GJL1311903R8100	3/31
VB7-30-10-F-84	GJL1311903R8104	3/31
VB7-30-10-F-85	GJL1311903R8105	3/31
VB7-30-10-P-01	GJL1311909R0101	3/21
VB7-30-10-P-02	GJL1311909R0102	3/21
VB7-30-10-P-03	GJL1311909R0103	3/21
VB7-30-10-P-80	GJL1311909R8100	3/21
VB7-30-10-P-84	GJL1311909R8104	3/21
VB7-30-10-P-85	GJL1311909R8105	3/21
VB7A-30-01-01	GJL1311911R0011	3/8
VB7A-30-01-02	GJL1311911R0012	3/8
VB7A-30-01-03	GJL1311911R0013	3/8
VB7A-30-01-80	GJL1311911R8010	3/8
VB7A-30-01-84	GJL1311911R8014	3/8
VB7A-30-01-85	GJL1311911R8015	3/8
VB7A-30-01-F-01	GJL1311913R0011	3/33
VB7A-30-01-F-02	GJL1311913R0012	3/33
VB7A-30-01-F-03	GJL1311913R0013	3/33
VB7A-30-01-F-80	GJL1311913R8010	3/33
VB7A-30-01-F-84	GJL1311913R8014	3/33
VB7A-30-01-F-85	GJL1311913R8015	3/33
VB7A-30-01-P-01	GJL1311919R0011	3/23
VB7A-30-01-P-02	GJL1311919R0012	3/23
VB7A-30-01-P-03	GJL1311919R0013	3/23
VB7A-30-01-P-80	GJL1311919R8010	3/23
VB7A-30-01-P-84	GJL1311919R8014	3/23
VB7A-30-01-P-85	GJL1311919R8015	3/23
VB7A-30-10-01	GJL1311911R0101	3/8
VB7A-30-10-02	GJL1311911R0102	3/8
VB7A-30-10-03	GJL1311911R0103	3/8
VB7A-30-10-80	GJL1311911R8100	3/8
VB7A-30-10-84	GJL1311911R8104	3/8
VB7A-30-10-85	GJL1311911R8105	3/8
VB7A-30-10-F-01	GJL1311913R0101	3/33
VB7A-30-10-F-02	GJL1311913R0102	3/33
VB7A-30-10-F-03	GJL1311913R0103	3/33
VB7A-30-10-F-80	GJL1311913R8100	3/33
VB7A-30-10-F-84	GJL1311913R8104	3/33
VB7A-30-10-F-85	GJL1311913R8105	3/33
VB7A-30-10-P-01	GJL1311919R0101	3/23
VB7A-30-10-P-02	GJL1311919R0102	3/23
VB7A-30-10-P-03	GJL1311919R0103	3/23
VB7A-30-10-P-80	GJL1311919R8100	3/23
VB7A-30-10-P-84	GJL1311919R8104	3/23
VB7A-30-10-P-85	GJL1311919R8105	3/23
VBC6-30-01-01	GJL1213901R0011	3/7
VBC6-30-01-03	GJL1213901R0013	3/7
VBC6-30-01-04	GJL1213901R0014	3/7
VBC6-30-01-05	GJL1213901R0015	3/7
VBC6-30-01-07	GJL1213901R0017	3/7
VBC6-30-01-16	GJL1213901R0116	3/7
VBC6-30-01-P-01	GJL1213909R0011	3/22
VBC6-30-01-P-03	GJL1213909R0013	3/22
VBC6-30-01-P-04	GJL1213909R0014	3/22
VBC6-30-01-P-05	GJL1213909R0015	3/22
VBC6-30-01-P-07	GJL1213909R0017	3/22
VBC6-30-01-P-16	GJL1213909R0116	3/22
VBC6-30-10-P-04	GJL1213901R0104	3/7
VBC6-30-10-P-05	GJL1213901R0105	3/7
VBC6-30-10-P-06	GJL1213909R0106	3/22
VBC6-30-10-P-07	GJL1213909R0107	3/22
VBC6A-30-01-01	GJL1213911R0011	3/9
VBC6A-30-01-03	GJL1213911R0013	3/9

Type	Order code	Page
VBC6A-30-01-04	GJL1213911R0014	3/9
VBC6A-30-01-05	GJL1213911R0015	3/9
VBC6A-30-01-07	GJL1213911R0017	3/9
VBC6A-30-01-16	GJL1213911R0116	3/9
VBC6A-30-10-01	GJL1213911R0101	3/9
VBC6A-30-10-03	GJL1213911R0103	3/9
VBC6A-30-10-04	GJL1213911R0104	3/9
VBC6A-30-10-05	GJL1213911R0105	3/9
VBC6A-30-10-07	GJL1213911R0107	3/9
VBC6A-30-10-16	GJL1213911R0116	3/9
VBC7-30-01-01	GJL1313901R0011	3/7
VBC7-30-01-03	GJL1313901R0013	3/7
VBC7-30-01-04	GJL1313901R0014	3/7
VBC7-30-01-05	GJL1313901R0015	3/7
VBC7-30-01-07	GJL1313901R0017	3/7
VBC7-30-01-16	GJL1313901R0116	3/7
VBC7-30-01-F-01	GJL1313903R0011	3/32
VBC7-30-01-F-03	GJL1313903R0013	3/32
VBC7-30-01-F-04	GJL1313903R0014	3/32
VBC7-30-01-F-05	GJL1313903R0015	3/32
VBC7-30-01-F-07	GJL1313903R0017	3/32
VBC7-30-01-F-16	GJL1313903R0116	3/32
VBC7-30-01-P-01	GJL1313909R0011	3/22
VBC7-30-01-P-03	GJL1313909R0013	3/22
VBC7-30-01-P-04	GJL1313909R0014	3/22
VBC7-30-01-P-05	GJL1313909R0015	3/22
VBC7-30-01-P-07	GJL1313909R0017	3/22
VBC7-30-01-P-16	GJL1313909R0116	3/22
VBC7-30-10-01	GJL1313901R0101	3/7
VBC7-30-10-03	GJL1313901R0103	3/7
VBC7-30-10-04	GJL1313901R0104	3/7
VBC7-30-10-05	GJL1313901R0105	3/7
VBC7-30-10-07	GJL1313901R0107	3/7
VBC7-30-10-16	GJL1313901R0116	3/7
VBC7-30-10-F-01	GJL1313903R0101	3/32
VBC7-30-10-F-03	GJL1313903R0103	3/32
VBC7-30-10-F-04	GJL1313903R0104	3/32
VBC7-30-10-F-05	GJL1313903R0105	3/32
VBC7-30-10-F-07	GJL1313903R0107	3/32
VBC7-30-10-F-16	GJL1313903R0116	3/32
VBC7-30-10-P-01	GJL1313909R0101	3/22
VBC7-30-10-P-03	GJL1313909R0103	3/22
VBC7-30-10-P-04	GJL1313909R0104	3/22
VBC7-30-10-P-05	GJL1313909R0105	3/22
VBC7-30-10-P-07	GJL1313909R0107	3/22
VBC7-30-10-P-16	GJL1313909R0116	3/22
VBC7A-30-01-01	GJL1313911R0011	3/9
VBC7A-30-01-03	GJL1313911R0013	3/9
VBC7A-30-01-04	GJL1313911R0014	3/9
VBC7A-30-01-05	GJL1313911R0015	3/9
VBC7A-30-01-07	GJL1313911R0017	3/9
VBC7A-30-01-16	GJL1313911R0016	3/9
VBC7A-30-01-F-01	GJL1313913R0011	3/34
VBC7A-30-01-F-03	GJL1313913R0013	3/34
VBC7A-30-01-F-04	GJL1313913R0014	3/34
VBC7A-30-01-F-05	GJL1313913R0015	3/34
VBC7A-30-01-F-07	GJL1313913R0017	3/34
VBC7A-30-01-F-16	GJL1313913R0116	3/34
VBC7A-30-01-P-01	GJL1313919R0011	3/24
VBC7A-30-01-P-03	GJL1313919R0013	3/24
VBC7A-30-01-P-04	GJL1313919R0014	3/24
VBC7A-30-01-P-05	GJL1313919R0015	3/24
VBC7A-30-01-P-07	GJL1313919R0017	3/24
VBC7A-30-01-P-16	GJL1313919R0116	3/24
VBC7A-30-10-01	GJL1313911R0101	3/9
VBC7A-30-10-03	GJL1313911R0103	3/9
VBC7A-30-10-04	GJL1313911R0104	3/9
VBC7A-30-10-05	GJL1313911R0105	3/9
VBC7A-30-10-07	GJL1313911R0107	3/9
VBC7A-30-10-16	GJL1313911R0116	3/9
VBC7A-30-10-F-01	GJL1313913R0101	3/34
VBC7A-30-10-F-03	GJL1313913R0103	3/34
VBC7A-30-10-F-04	GJL1313913R0104	3/34
VBC7A-30-10-F-05	GJL1313913R0105	3/34
VBC7A-30-10-F-07	GJL1313913R0107	3/34
VBC7A-30-10-F-16	GJL1313913R0116	3/34
VBC7A-30-10-P-01	GJL1313919R0101	3/24
VBC7A-30-10-P-03	GJL1313919R0103	3/24
VBC7A-30-10-P-04	GJL1313919R0104	3/24
VBC7A-30-10-P-05	GJL1313919R0105	3/24
VBC7A-30-10-P-07	GJL1313919R0107	3/24
VBC7A-30-10-P-16	GJL1313919R0116	3/24
VE5-2	1SBN030210R1000	5/385
VEM4	1SBN030111R1000	5/89
VH800	SK829070-F	5/213
VM140/190	1SBN034403R1000	5/95
VM1650H	1SBN036503R1001	5/352
VM19	1SBN030300R1000	5/95
VM205/265	1SBN035203R1000	5/95
VM3	1SBN031005T1000	4/14

Type	Order code	Page
VM4	1SBN030105T1000	5/89
VM750H	1SBN035700R1000	5/107
VM750V	1SBN035701R1000	5/352
VM96-4	1SBN033405T1000	5/89
WB75-A	FPTN372726R1001	5/358
	FPTN372726R1002	5/358
	FPTN372726R1003	5/358
	FPTN372726R1004	5/358
	FPTN372726R1005	5/358
	FPTN372726R1006	5/358
	FPTN372726R1007	5/358
	FPTN372726R1008	5/358
WRB-1000	1SAZ701903R1013	7/46
WRB-400	1SAZ701903R1011	7/46
WRB-600	1SAZ701903R1012	7/46
WRBG	1SAZ701903R1030	7/46
WRH-F	1SAZ701903R1001	7/46
XT2S 160	1SDA068164R1	5/20
XT2S 160 MA 160	1SDA076530R1	5/22
XT4S 250 Ekip I ln250	1SDA068480R1	5/22
ZA110	1SBN154310R8006	5/397
	1SBN154310R8106	5/397
	1SBN154310R8306	5/397
	1SBN154310R8406	5/397
	1SBN154310R8506	5/397
	1SBN154310R8606	5/397
	1SBN154310R8806	5/397
ZA16	1SBN151410R8006	5/397
	1SBN151410R8106	5/397
	1SBN151410R8306	5/397
	1SBN151410R8406	5/397
	1SBN151410R8506	5/397
	1SBN151410R8606	5/397
	1SBN151410R8806	5/397
ZA40	1SBN152410R8006	5/397
	1SBN152410R8106	5/397
	1SBN152410R8306	5/397
	1SBN152410R8406	5/397
	1SBN152410R8506	5/397
	1SBN152410R8606	5/397
	1SBN152410R8806	5/397
ZA75	1SBN153510R8006	5/397
	1SBN153510R8106	5/397
	1SBN153510R8306	5/397
	1SBN153510R8406	5/397
	1SBN153510R8506	5/397
	1SBN153510R8606	5/397
	1SBN153510R8806	5/397
ZAF1650	1SBN156570R7026	5/373
ZAF2650	1SBN156670R7026	5/373
ZAF460	1SBN155770R6806	5/373
	1SBN155770R6906	5/373
	1SBN155770R7006	5/373
	1SBN155770R7106	5/373
ZAF750	1SBN156170R6806	5/373
	1SBN156170R6906	5/373
	1SBN156170R7006	5/373
	1SBN156170R7106	5/373
ZL1250	1SBN166403R1000	5/373
ZL1350	1SBN166503R1000	5/373
ZL1350-1	1SBN166503R1001	5/373
ZL1650	1SBN166703R1000	5/373
ZL1650-1	1SBN166703R1001	5/373
ZL2050	1SBN167003R1000	5/373
ZL2050-1	1SBN167003R1001	5/373
ZL2650	1SBN166603R1000	5/373
ZL400	1SBN165703R1000	5/373
ZL460	1SBN165903R1000	5/373
ZL580	1SBN166103R1000	5/373
ZL750	1SBN166303R1000	5/373
ZLU110	1SBN164502R1000	5/397
ZLU50	1SBN163502R1000	5/397
ZLU63	1SBN163702R1000	5/397
ZLU75	1SBN164102R1000	5/397
ZLU95	1SBN164302R1000	5/397
ZP1650	1SBN166521R1070	5/373
ZP2650	1SBN166621R1070	5/373
ZW1650	1SBN166510R1000	5/373
ZW2650	1SBN166610R1000	5/373
ZW460	1SBN165710R1000	5/373
ZW750	1SBN166110R1000	5/373

Marketing material

<http://new.abb.com/low-voltage/products/motor-protection>

HOME • PRODUCTS • LOW VOLTAGE PRODUCTS • MOTOR PROTECTION AND CONTROL

GLOBAL SITE Power and productivity for a better world™ **ABB**

Motor protection and control



To keep it running, you need Control

ABB's motor protection and control offering is among the widest on the market. From system integrator, OEM, engineering consultant and distributor to panel builder and industrial end-user, our comprehensive range of motor starting solutions, products and services delivers the certainty of consistent quality and performance.





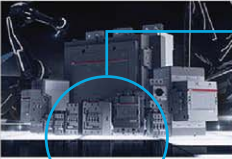







Are you looking for support or purchase information?
↓ [Contact us](#)

Highlights

-  [AF contactor launch](#)
-  [Gamesa chooses AF](#)
-  [ADL and Free Tech cuts logistic costs](#)

Our offering

-  Starting solutions
Get the perfect match
→ [Link](#)
-  Motor protection
A complete motor protection concept
→ [Link](#)
-  3-pole contactors and overload relays
For motor starting and power switching
→ [Link](#)
-  4-pole contactors
For power switching
→ [Link](#)
-  R bar contactors for advanced and heavy duty applications
Tailored to your needs
→ [Link](#)
-  Contactor relays
For switching control and auxiliary circuits
→ [Link](#)
-  Contactors for capacitor switching
Withstand unlimited peak current
→ [Link](#)
-  Contactors for DC switching
For a compact and efficient way of DC switching
→ [Link](#)
-  Contactors for railway applications
Meeting the most stringent standards and requirements
→ [Link](#)
-  Installation contactors
Noiseless control
→ [Link](#)

Products and documents

Documents **Tools**

Download related documents for Contactors

You now see 5 documents within → [Advanced search](#) → Documents in all languages

Category	Document Name	Language	Year	Size	Format
Popular documents (5)	ESB Installation contactors - Technical catalogue	English	2010-02-08	0,66 MB	PDF
Brochure (10)	ePLAN Electric P8 product data - Mini Contactors, Mini Contactor Relays, Mini Reversing Contactors and Accessories	English, German	2011-06-17	0,08 MB	ZIP
CAD outline drawing (1)	Block contactors	English	2005-01-27	5,80 MB	PDF
Catalogue (30)	Main catalog Motor protection and control	English	2013-06-04	94,02 MB	PDF
Certificate (500)	Modular DIN rail components - Installation contactors	English	2014-03-27	0,75 MB	PDF
Circuit diagram (12)					
Course description (1)					

News

- 2014-11-20: No job too dirty for ABB products
- 2014-11-06: Prost! ABB keeps Oktoberfest beer flowing
- 2014-09-26: ABB's Business Unit Control Products attends first Automation & Power World in Mexico
- 2014-07-24: Product of the year - ABB's AF contactor
- 2014-07-09: New ABB AF range contactors reduce SKUs by 90 percent
- 2014-06-19: ABB inaugurates new factory in Bulgaria

14

Videos, prints, technical presentations and more



Videos



Success stories

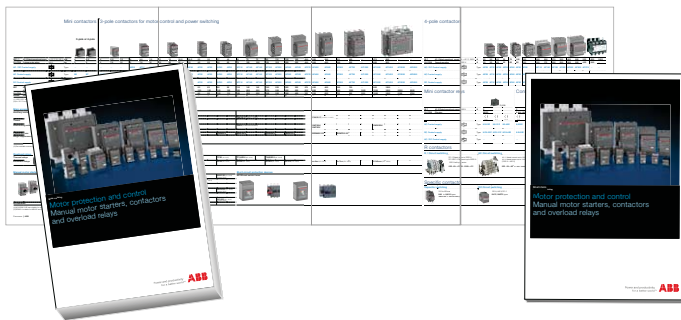

Main catalog : 1SBC100192C0204
 Short form catalog : 1SBC100197C0202
 Panorama : 1SBC100196L0203

For direct product details information,
 use product type or order code, ex:
www.abb.com/productdetails/AF09-30-10-13 or
www.abb.com/productdetails/1SBL137001R1310

Block Contactors

Overview Data Contacts

AF09-30-10-13

General information

Extended Product Type: AF09-30-10-13
 Product ID: 1SBL137001R1310
 EAN: 3471223110038
 Catalog Description: AF09-30-10-13 100-250V/50/60HZ DC Contactor

Long Description:

AF09 contactors are used for controlling power circuits up to 690 V AC and 220 V DC. They are mainly used for controlling 3-phase motors, non-inductive or slightly inductive loads. AF⁺ contactors include an electronic coil interface accepting a wide control voltage (U_c min. = U_c max. Only four coils cover control voltages between 24 - 500 V (50/60 Hz or 25 - 500 V DC). AF⁺ contactors can manage large control voltage variations. One coil can be used for different control voltages used worldwide without any coil change. AF⁺ contactors have built-in surge protection and do not require additional surge suppressors. The AF⁺ series is track 3.



Print View
Print to PDF
Download

Userfriendly web design



Tools

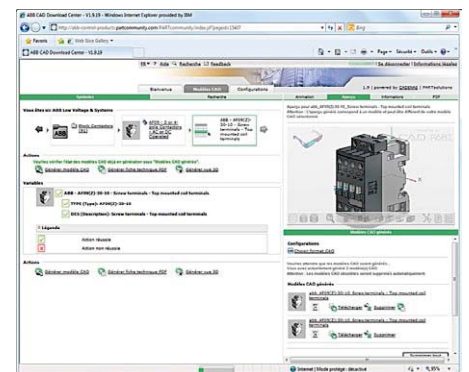

Cadenas portal: Download 2D or 3D files according to your needs (STEP, IGES...)

Coordination tables for motor protection

Selected Optimized Coordination

63 records (2/24 selected) Show relevant ABB products only. 0/1 Number of Records to show: 20

The oldest tables matching your search are shown (Current and Voltage Start Search is on)

Protection Device	Rated Voltage	Short-Circuit Current (kA)	Starter Type	Coordination Type	Overcurrent Relay	Motor Name Power (kW/HP)
ABB AF09	400V AC	5	DDC-MS	IEC Type 1	Embedded	0.06
ABB AF09	400V AC	10	DDC-MS	UL Type 4	ICL	0.09
ABB AF09	400V AC	12	DDC-MS	UL Type 5	ICL	0.10
ABB AF09	400V AC	16	DDC-MS	UL Type 6	ICL	0.13
ABB AF09	400V AC	20	UL	UL Type 8	ICL	0.17
ABB AF09	400V AC	27	UL	UL Type 10	ICL	0.22
ABB AF09	400V AC	35	UL	UL Type 12	ICL	0.28

Motor Power (kW)	Rated Current (A)	Short-Circuit Current (kA)	Coordination Type	Overcurrent Relay	Max. allowed lead current (A)
0.06	0.20	10	IEC	ICL	0.20
0.09	0.25	12	UL	ICL	0.25
0.10	0.25	12	UL	ICL	0.25
0.13	0.30	16	UL	ICL	0.30
0.17	0.35	20	UL	ICL	0.35
0.22	0.40	27	UL	ICL	0.40
0.28	0.45	35	UL	ICL	0.45

SOC II: Select the Optimized Coordination tables for your starter according to IEC or UL standard

Contact us

ABB France
Low Voltage Products Division
3, rue Jean Perrin
F-69687 Chassieu cedex / France

ABB STOTZ-KONTAKT GmbH
Eppelheimer Straße 82
D-69123 Heidelberg / Germany

ABB AB
Control Products
Low Voltage Products
SE-721 61 Västerås / Sweden

You can find the address of your local sales organisation
on the [ABB home page](#)



<http://new.abb.com/low-voltage/products/motor-protection>



<http://www.abb.com/lowvoltage>

Note

We reserve the right to make technical changes or modify the contents of this document without prior notice.

ABB does not accept any responsibility whatsoever for potential errors or possible lack of information in this document.

We reserve all rights in this document and in the subject matter and illustrations contained therein. Any reproduction, disclosure to third parties or utilization of its contents – in whole or in parts – is forbidden without prior written consent of ABB.

Copyright© 2015 ABB - All rights reserved