

Electric Motors

IE2 Motors

Marine

hoyermotors.com

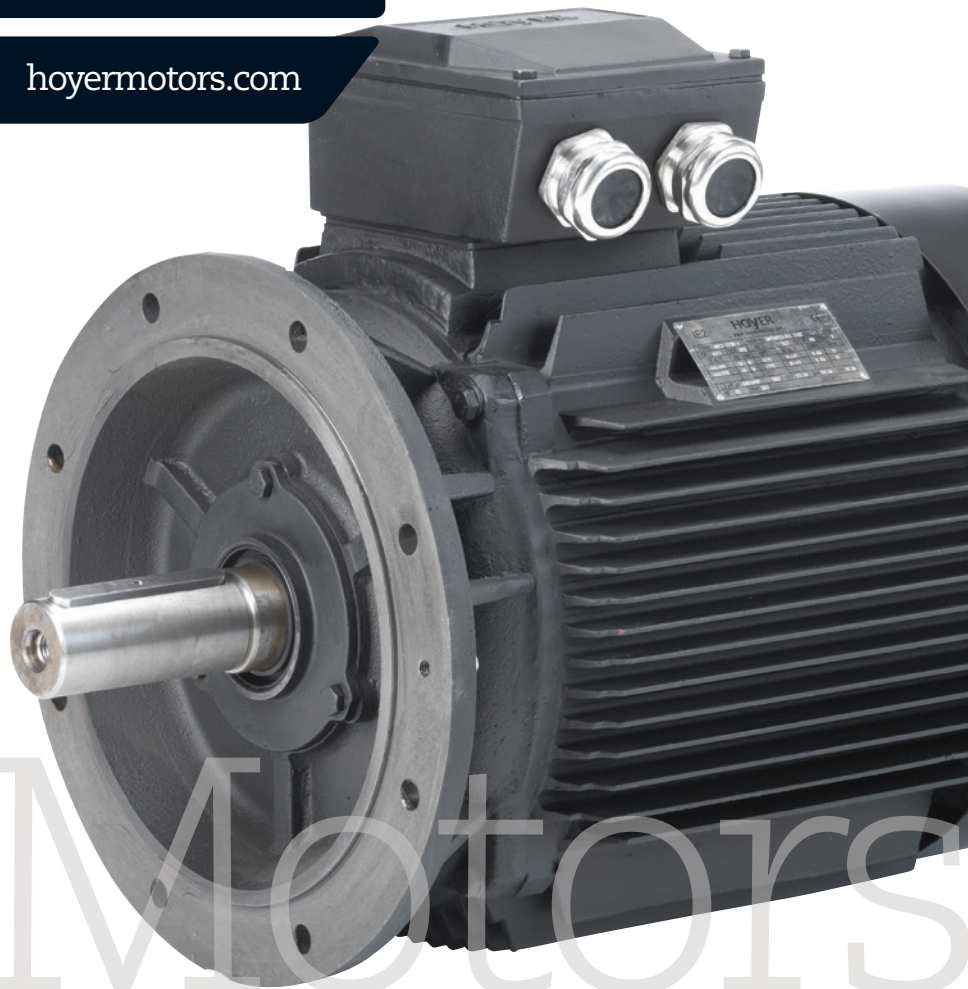

IE2 Motors

GREEN responsibility

HOYER
MOTORS

Behind Hoyer Motors



HOYER

EXCEEDING EXPECTATIONS

Svend Hoyer A/S is an international company comprising the two business units Hoyer Motors and Hoyer Transmissions. Headquartered in Denmark and China, we are represented through subsidiaries and sales offices in a number of countries across the globe. We pride ourselves of being an elite manufacturing enterprise with the highest attention to service and support – a company where dedication, competitiveness and reliability are second to none.

At Svend Hoyer A/S, meeting agreements is as natural as breathing air. Our motto: A promise is a promise, is the foundation for always supplying solutions that meet – or, indeed, exceed our customers' expectations in every respect. Our business policy is always to be direct in our approach, even in the rare case of complaint or criticism.

In other words, Svend Hoyer A/S is a company you can rely on. A trustworthy business partner that always meets our obligations on deliveries and technical solutions – both in the short and long term. This is what we mean by Exceeding Expectations.

General information about Hoyer IE2 marine electric motors

Hoyer IE2 marine electric motors are manufactured according to international standards under IEC, and can be delivered with certificates from the major international classifications societies.

Hoyer IE2 marine electric motors are type approved by BV, GL and ABS (design approval).

Hoyer motors are installed in many different industrial and marine fields all over the world, and with a proven quality, high reliability and performance, Hoyer Motors is a known brand in the market.

Technical information

Totally enclosed squirrel cage, TEFV, three phase motors type HMA2 (aluminum) in size 56 to 132 (size 160 and 180 on request) and type HMC2 (cast iron) in size 160 to 400 (below size 160 and bigger than size 400 on request).

Rotor is casted with 100% pure aluminum and shaft is made of high quality C45 steel.

HMC2 motors are provided with SKF bearings. HMA2 motors are supplied with C&U bearings. All sizes have fixed bearing in drive-end as standard.

Motors from size 56 to 225, both sizes included, are provided with closed bearings greased for life. Larger motors are provided with open type bearings suitable for re-greasing.

Stator winding is made with double coated copper wire and phase to phase insulation. The insulation system is Class F, maximum 105K temperature rise at 40°C ambient temperature.

Motors below 200kW are with Class B temperature rise.

Class H insulation system can be delivered on request.

All motors are manufactured according to IEC 60034, IEC60072, EN50347 and tested according to IEC60034-2-1.

Rotor is dynamically balanced with half key, to full-fill vibration level IEC60034-14 grade A.

Sound level within limits of IEC60034-9.

Hoyer IE2 marine electric motors ≤ 3 kW are manufactured for 254/440V 60Hz and > 3 kW for 440/760V 60Hz. Other voltages can be supplied on request. The motors fulfill IE2 efficiency demands at 230/400V 50Hz and 400/690V 50Hz.

All Hoyer IE2 marine electric motors are supplied with PTC terminal protection and motors \geq frame size 160 with heating elements for stand still protection as standard. Motors can be modified with bimetal detector and PT100 for both winding and bearings on request.

Protection is IP55 with shaft sealing as standard, higher protection class on request.

Motor size ≥ 100 are supplied with eyebolts for lifting.

Hoyer IE2 marine electric motors are painted black RAL 9005 low gloss for use in normal industrial environments and below deck. Special painting can be supplied on request.

Application info

Hoyer IE2 marine electric motors are used within a wide variety of applications. Below some of the typical applications are listed:

- Fans (air handling units, refrigeration plants, oil coolers)
- Hydraulic power packs
- Pumps (for water, fuel, oil)
- Compressors
- Thrusters
- Winches and hoists
- Cranes



IE2 / 2 pol Marine

Motor type	440V 60Hz S1-45°C			380V 50Hz S1-45°C			400V 50Hz S1-40°C			Efficiency (%)			Pf	Torque			IM	Weight	
	P2	Speed	I _N	P2	Speed	I _N	P2	Speed	I _N	I _s /I _N	¹ / ₁ load	³ / ₄ load	¹ / ₂ load	cos φ	T _N	T _s /T _N	T _M /T _N	J(kg·m ²)	kg
	kw	rpm	A	kw	rpm	A	kw	rpm	A										

Aluminium motors

HMA2 56 1-2	0,11	3300	0,38	0,09	2720	0,37	0,09	2720	0,35	6,0	62	59	55	0,68	0,31	2,3	2,4	0,00010	3,7
HMA2 56 2-2	0,14	3300	0,41	0,12	2720	0,4	0,12	2720	0,38	6,0	67	64	60	0,71	0,43	2,3	2,4	0,00012	3,9
HMA2 63 1-2	0,21	3300	0,58	0,17	2720	0,55	0,18	2720	0,53	6,0	69	67	64	0,75	0,63	2,2	2,4	0,00013	4,1
HMA2 63 2-2	0,29	3300	0,8	0,24	2720	0,79	0,25	2720	0,75	6,0	68	66	63	0,76	0,88	2,2	2,4	0,00015	4,6
HMA2 71 1-2	0,43	3300	1,05	0,35	2730	1,0	0,37	2730	0,95	6,0	70	69	67	0,82	1,3	2,2	2,4	0,00044	6,0
HMA2 71 2-2	0,64	3310	1,45	0,53	2730	1,4	0,55	2730	1,33	6,0	73	72	70	0,82	1,9	2,2	2,4	0,00055	6,5
HMA2 80 1-2	0,87	3420	1,7	0,73	2850	1,75	0,75	2850	1,7	7,5	81,4	81,2	78,3	0,81	2,5	2,5	3,2	0,0011	9,0
HMA2 80 2-2	1,26	3420	2,5	1,07	2850	2,4	1,1	2850	2,3	7,7	80,9	79,9	76,1	0,82	3,6	3,2	3,3	0,0013	11
HMA2 90S-2	1,75	3450	3,2	1,46	2850	3,2	1,5	2850	3,1	8,4	83,5	83,0	80,2	0,85	4,9	2,9	3,1	0,0018	15
HMA2 90L-2	2,5	3450	4,5	2,13	2850	4,5	2,2	2850	4,4	8,5	85,7	85,8	83,9	0,85	7,2	2,9	3,2	0,0022	17
HMA2 100L-2	3,5	3460	6,2	2,9	2890	6,0	3,0	2890	5,8	8,7	85,7	85,5	83,4	0,87	9,9	3,1	3,5	0,0043	23
HMA2 112M1-2	4,7	3480	7,8	3,9	2900	7,7	4,0	2900	7,5	8,4	87,0	87,1	85,4	0,90	13	3,2	3,4	0,0065	32
HMA2 132S1-2	6,4	3490	11	5,3	2880	11	5,5	2880	10,5	8,4	87,0	86,3	83,6	0,89	18	2,4	3,5	0,015	45
HMA2 132S2-2	8,7	3490	14,5	7,3	2900	14	7,5	2900	13,5	8,4	88,1	87,6	85,3	0,90	25	2,4	3,5	0,016	51

Cast iron motors

HMC2 80 1-2	0,87	3420	1,8	0,73	2850	1,8	0,75	2850	1,8	7,0	77,4	77,2	74,5	0,83	2,5	2,2	2,3	0,0009	20
HMC2 80 2-2	1,26	3420	2,6	1,07	2850	2,6	1,1	2850	2,4	7,9	79,6	79,4	76,9	0,83	3,6	2,2	2,3	0,0010	23
HMC2 90S-2	1,75	3420	3,4	1,46	2850	3,4	1,5	2850	3,2	7,9	81,3	81,1	78,7	0,84	4,9	2,2	2,3	0,0022	29
HMC2 90L-2	2,5	3420	4,8	2,13	2850	4,6	2,2	2850	4,6	7,9	83,2	83,1	80,8	0,85	7,2	2,2	2,3	0,0030	33
HMC2 100L-2	3,5	3440	6,2	2,9	2870	6,0	3,0	2870	6,0	8,1	84,6	84,5	82,4	0,87	9,9	2,2	2,3	0,0051	42
HMC2 112M-2	4,7	3450	8,0	3,9	2880	7,8	4,0	2880	7,8	8,1	85,8	85,7	83,7	0,88	13	2,2	2,3	0,0068	53
HMC2 132S1-2	6,4	3480	11	5,3	2900	10,5	5,5	2900	10,5	8,1	87,0	86,9	85,1	0,88	18	2,2	2,3	0,015	66
HMC2 132S2-2	8,7	3480	14,5	7,3	2900	14,5	7,5	2900	14	8,1	88,1	88,0	86,3	0,88	25	2,2	2,3	0,018	72
HMC2 160M1-2	12,8	3520	21	10,6	2930	20	11	2930	20	7,9	89,4	89,3	87,5	0,89	36	2,2	2,3	0,040	123
HMC2 160M2-2	17,5	3520	28,5	14,5	2930	28	15	2930	27	8,0	90,3	90,3	89,2	0,89	49	2,2	2,3	0,047	132
HMC2 160L-2	21,5	3520	35	17,9	2930	34	18,5	2930	33	8,1	90,9	91,3	90,4	0,89	60	2,2	2,3	0,058	151
HMC2 180M-2	25,6	3530	42	21,3	2940	40	22	2940	39	8,2	91,3	91,1	89,7	0,89	71	2,2	2,3	0,079	203
HMC2 200L1-2	34,9	3540	57	29,1	2950	54	30	2950	53	7,5	92,0	92,2	90,7	0,89	97	2,2	2,3	0,130	246
HMC2 200L2-2	43	3540	69	35,9	2950	67	37	2950	65	7,5	92,5	92,7	90,1	0,89	119	2,2	2,3	0,146	256
HMC2 225M-2	52,4	3550	83	43,6	2960	80	45	2960	78	7,6	92,9	92,4	90,5	0,89	145	2,2	2,3	0,246	328
HMC2 225M1-2*	64	3550	101	53,4	2960	99	55	2960	96	10,2	93,2	93,1	92,3	0,89	177	2,0	2,3	0,337	355
HMC2 250M-2	64	3550	100	53,3	2970	98	55	2970	96	7,6	93,2	92,7	90,8	0,89	177	2,2	2,3	0,328	433
HMC2 250M1-2*	87,3	3560	136	72,8	2970	134	75	2970	130	9,0	93,8	93,7	92,8	0,89	241	2,0	2,3	0,602	433
HMC2 280S-2	87	3570	137	72,7	2970	134	75	2970	129	6,9	93,8	93,6	92,5	0,89	240	2,0	2,3	0,627	572
HMC2 280M-2	104	3560	159	87,3	2970	158	90	2970	155	7,0	94,1	93,9	92,8	0,89	289	2,0	2,3	0,709	632
HMC2 315S-2	128	3570	198	106	2980	190	110	2980	187	7,1	94,3	94,0	92,8	0,90	352	2,0	2,2	1,124	850
HMC2 315M-2	153	3570	236	128	2980	230	132	2980	223	7,1	94,6	94,0	92,8	0,90	425	2,0	2,2	1,91	930
HMC2 315L1-2	186	3570	283	155	2980	270	160	2980	267	7,1	94,8	94,1	92,9	0,91	513	2,0	2,2	2,18	1020
HMC2 315L2-2	232	3570	359	194	2980	340	200	2980	334	7,1	95,0	94,1	92,9	0,91	640	2,0	2,2	2,53	1120
HMC2 355M-2	291	3570	437	242	2980	425	250	2980	417	7,1	95,0	94,9	94,5	0,91	800	2,0	2,2	4,52	1820
HMC2 355L1-2	366	3570	549	305	2980	535	315	2980	526	7,1	95,0	94,9	94,5	0,91	1010	2,0	2,2	5,35	1850
HMC2 355L2-2	413	3570	620	344	2980	600	355	2980	590	7,1	95,3	95,3	95,0	0,92	1135	1,8	2,2	5,10	2150
HMC2 400M2-2	465	3570	710	388	2980	686	400	2980	675	7,1	95,5	95,5	95,2	0,92	1280	1,8	2,2	5,57	2950
HMC2 400M3-2	524	3570	800	436	2980	768	450	2980	755	7,1	95,5	95,5	95,2	0,92	1430	1,8	2,2	7,05	3200
HMC2 400L1-2	582	3580	880	485	2985	844	500	2985	830	7,0	95,8	95,8	95,5	0,92	1595	1,8	2,2	7,10	3250
HMC2 400L2-2	652	3580	985	543	2985	946	560	2985	930	7,0	95,8	95,8	95,5	0,92	1780	1,8	2,2	7,15	3300

*Motors with high power / small frame

IE2 / 4 pol Marine

Motor type	440V 60Hz S1-45°C			380V 50Hz S1-45°C			400V 50Hz S1-40°C			Efficiency (%)			Pf	Torque			IM	Weight	
	P2	Speed	I _N	P2	Speed	I _N	P2	Speed	I _N	I _s /I _N	¹ / ₁ load	³ / ₄ load	¹ / ₂ load	cos φ	T _N	T _s /T _N	T _M /T _N	J(kg·m ²)	kg
	kw	rpm	A	kw	rpm	A	kw	rpm	A										

Aluminium motors

HMA2 56 1-4	0,07	1650	0,38	0,06	1380	0,38	0,06	1380	0,35	6,0	46	43	38	0,58	0,42	2,3	2,4	0,00020	3,5
HMA2 56 2-4	0,11	1650	0,45	0,09	1380	0,42	0,09	1380	0,40	6,0	49	46	41	0,55	0,62	2,3	2,4	0,00021	3,7
HMA2 63 1-4	0,14	1620	0,55	0,12	1350	0,53	0,12	1350	0,50	6,0	53	50	45	0,63	0,85	2,2	2,4	0,00025	4,0
HMA2 63 2-4	0,21	1610	0,77	0,17	1340	0,75	0,18	1340	0,71	6,0	56	53	48	0,62	1,3	2,2	2,4	0,00028	4,2
HMA2 71 1-4	0,29	1650	0,87	0,24	1390	0,84	0,25	1390	0,80	6,0	65	62	58	0,68	1,7	2,2	2,4	0,00044	6,0
HMA2 71 2-4	0,43	1640	1,2	0,35	1380	1,15	0,37	1380	1,1	6,0	67	64	60	0,73	2,6	2,2	2,4	0,00054	6,4
HMA2 80 1-4	0,64	1640	1,6	0,53	1370	1,6	0,55	1370	1,52	6,0	73	72	68	0,73	3,8	2,2	2,4	0,0012	9,5
HMA2 80 2-4	0,87	1690	1,8	0,73	1420	1,85	0,75	1420	1,8	5,9	80,8	81,1	78,8	0,78	5,0	2,5	2,6	0,0017	13
HMA2 90S-4	1,26	1710	2,7	1,07	1420	2,7	1,1	1420	2,6	5,5	81,5	81,2	79,6	0,73	7,4	2,5	3,2	0,0023	17
HMA2 90L-4	1,75	1730	3,7	1,46	1450	3,6	1,5	1450	3,4	6,6	84,4	83,7	80,6	0,71	9,9	2,7	3,4	0,0031	18
HMA2 100L1-4	2,5	1720	4,9	2,13	1440	4,8	2,2	1440	4,6	7,3	85,2	84,8	82,3	0,78	14,5	2,5	3,4	0,0078	26
HMA2 100L2-4	3,5	1720	6,8	2,9	1440	6,4	3,0	1440	6,1	7,3	86,3	85,9	83,6	0,77	20	2,6	3,4	0,0087	28
HMA2 112M2-4	4,7	1730	8,3	3,9	1450	8,2	4,0	1450	7,9	7,1	86,7	86,9	85,2	0,84	26	2,2	2,9	0,019	37
HMA2 132S-4	6,4	1730	11,7	5,3	1450	11,5	5,5	1450	11	7,5	88,4	88,1	86,2	0,80	36	2,3	3,3	0,033	51
HMA2 132M2-4	8,7	1740	15,5	7,3	1460	15,5	7,5	1460	15	7,3	88,9	89,1	87,9	0,82	49	2,2	3,2	0,041	62

Cast iron motors

HMC2 80 1-4	0,64	1710	1,4	0,53	1420	1,4	0,55	1420	1,4	5,7	77,0	76,8	74,1	0,75	3,8	2,4	2,3	0,0019	21
HMC2 80 2-4	0,87	1710	2,0	0,73	1420	2,0	0,75	1420	1,8	6,5	79,6	79,4	76,9	0,75	5,0	2,3	2,3	0,0021	22
HMC2 90S-4	1,26	1710	2,8	1,07	1420	2,8	1,1	1420	2,6	6,5	81,4	81,2	78,8	0,75	7,4	2,3	2,3	0,0037	29
HMC2 90L-4	1,75	1710	3,6	1,46	1420	3,6	1,5	1420	3,6	6,5	82,8	82,7	80,4	0,75	9,9	2,3	2,3	0,0049	34
HMC2 100L1-4	2,5	1720	4,8	2,13	1430	4,8	2,2	1430	4,6	7,5	84,3	84,2	82,0	0,81	14,5	2,3	2,3	0,0087	44
HMC2 100L2-4	3,5	1720	6,4	2,9	1430	6,4	3,0	1430	6,2	7,5	85,5	85,4	83,4	0,82	20	2,3	2,3	0,011	46
HMC2 112M1-4	4,7	1720	8,4	3,9	1440	8,4	4,0	1440	8,2	7,5	86,6	86,5	84,6	0,82	26	2,3	2,3	0,015	57
HMC2 132S-4	6,4	1730	11,5	5,3	1450	11,5	5,5	1450	11	7,5	87,7	87,6	85,9	0,83	36	2,3	2,3	0,037	68
HMC2 132M2-4	8,7	1730	15	7,3	1450	15	7,5	1450	14,5	7,5	88,7	88,6	87,0	0,84	49	2,3	2,3	0,047	80
HMC2 160M-4	12,8	1740	22	10,6	1460	22	11	1460	21	7,5	89,8	89,7	89,2	0,85	72	2,2	2,3	0,078	123
HMC2 160L-4	17,5	1740	30	14,5	1460	29	15	1460	28	7,5	90,6	90,5	87,9	0,86	98	2,2	2,3	0,096	153
HMC2 180M-4	21,5	1760	36	17,9	1470	35	18,5	1470	34	7,7	91,2	91,7	91,0	0,86	120	2,2	2,3	0,146	204
HMC2 180L-4	25,6	1760	42	21,3	1470	41	22	1470	41	7,8	91,6	91,9	91,3	0,86	143	2,2	2,3	0,166	215
HMC2 200L-4	34,9	1760	57	29,1	1470	56	30	1470	54	7,2	92,3	92,8	91,3	0,86	194	2,2	2,3	0,275	243
HMC2 200L1-4*	43,1	1765	70	35,9	1470	69	37	1470	67	8,3	92,7	92,6	91,5	0,86	240	2,2	2,3	0,483	318
HMC2 225S-4	43	1770	70	35,9	1475	69	37	1475	67	7,3	92,7	92,8	90,9	0,86	238	2,2	2,3	0,426	305
HMC2 225M-4	52,4	1770	85	43,6	1475	83	45	1475	81	7,4	93,1	93,1	91,3	0,86	290	2,2	2,3	0,492	328
HMC2 225M1-4*	64	1775	102	53,4	1480	101	55	1480	98	9,2	93,5	93,4	92,7	0,87	355	2,2	2,3	0,746	365
HMC2 250M-4	64	1775	103	53,3	1480	102	55	1480	99	7,4	93,5	93,8	91,5	0,86	354	2,2	2,3	0,693	452
HMC2 250M1-4*	87,3	1775	140	72,8	1480	138	75	1480	134	9,0	94,0	93,9	93,0	0,86	484	2,2	2,3	1,29	452
HMC2 280S-4	87	1775	139	72,7	1480	136	75	1480	130	6,7	94,0	94,2	92,4	0,88	483	2,2	2,3	1,18	592
HMC2 280M-4	104	1775	166	87,3	1480	162	90	1480	156	6,9	94,2	94,5	92,7	0,88	580	2,2	2,3	1,53	672
HMC2 280MB-4*	128	1775	202	107	1480	200	110	1480	194	9,3	94,5	94,4	93,6	0,87	710	2,1	2,2	2,87	672
HMC2 315S-4	128	1775	200	106	1480	196	110	1480	191	6,9	94,5	94,7	94,7	0,88	705	2,2	2,3	3,27	840
HMC2 315M-4	153	1775	239	128	1480	235	132	1480	228	6,9	94,7	94,9	94,3	0,88	850	2,2	2,3	3,80	930
HMC2 315L1-4	186	1775	287	155	1480	280	160	1480	273	6,9	94,9	95,2	94,7	0,89	1030	2,2	2,3	4,34	1000
HMC2 315L2-4	232	1775	357	194	1480	350	200	1480	341	6,9	95,1	95,3	94,8	0,89	1285	2,2	2,3	5,37	1080
HMC2 315L3-4*	291	1776	448	243	1480	438	250	1480	425	7,3	95,2	95,3	94,7	0,89	1606	2,2	2,4	6,7	1350
HMC2 355M-4	291	1775	443	242	1480	430	250	1480	425	6,9	95,1	95,5	94,8	0,90	1610	2,2	2,4	8,51	1650
HMC2 355L-4	366	1775	559	305	1480	545	315	1480	535	7,0	95,1	95,5	94,8	0,90	2025	2,2	2,4	10,8	1830
HMC2 355LB-4	413	1775	630	344	1480	615	355	1480	600	7,5	95,3	95,5	95,2	0,92	2285	2,2	2,4	12,4	2170
HMC2 400M1-4	465	1785	725	388	1490	705	400	1490	690	6,9	95,5	95,6	95,4	0,89	2565	1,4	3,0	14,9	3000
HMC2 400M2-4	524	1785	815	436	1490	795	450	1490	775	6,9	95,5	95,6	95,5	0,89	2885	1,4	3,0	15,2	3100
HMC2 400L1-4	582	1785	895	485	1490	870	500	1490	850	7,0	95,6	95,7	95,6	0,89	3200	1,3	3,0	18,5	3200
HMC2 400L2-4	652	1785	995	543	1490	965	560	1490	945	7,0	96,0	96,0	95,9	0,89	3590	1,4	3,0	19,4	3400
HMC2 400L3-4	733	1785	1165	611	1490	1135	630	1490	1110	7,1	96,0	96,1	96,0	0,89	4040	1,5	3,1	21,1	3500

*Motors with high power / small frame

IE2 / 6 pol Marine

Motor type	440V 60Hz S1-45°C			380V 50Hz S1-45°C			400V 50Hz S1-40°C			Efficiency (%)			Pf	Torque			IM	Weight	
	P2	Speed	I _N	P2	Speed	I _N	P2	Speed	I _N	I _s /I _N	1/1 load	3/4 load	1/2 load	cos φ	T _N	T _s /T _N	T _M /T _N	J(kgm ²)	kg
	kw	rpm	A	kw	rpm	A	kw	rpm	A										

Aluminium motors

HMA2 63 1-6	0,11	1000	0,59	0,09	830	0,57	0,09	830	0,54	6,0	38	34	28	0,67	1,0	2,2	2,4	0,00025	4,0
HMA2 63 2-6	0,14	1000	0,66	0,12	830	0,64	0,12	830	0,61	6,0	40	36	30	0,68	1,3	2,2	2,4	0,00032	4,2
HMA2 71 1-6	0,21	1080	0,76	0,17	900	0,73	0,18	900	0,70	6,0	59	56	52	0,66	1,9	2,2	2,4	0,00044	6,0
HMA2 71 2-6	0,29	1100	0,98	0,24	920	0,95	0,25	920	0,90	6,0	59	56	52	0,68	2,7	2,2	2,4	0,00055	6,5
HMA2 80 1-6	0,43	1080	1,35	0,35	900	1,31	0,37	900	1,25	6,0	62	60	57	0,70	3,9	2,2	2,4	0,0014	10
HMA2 80 2-6	0,64	1080	1,9	0,53	900	1,8	0,55	900	1,75	6,0	65	63	60	0,72	5,8	2,2	2,4	0,0019	12
HMA2 90S-6	0,87	1150	2,1	0,73	960	2,0	0,75	960	1,9	4,5	75,9	74,4	69,6	0,65	7,5	2,1	2,7	0,0032	17,5
HMA2 90L-6	1,26	1140	2,9	1,07	950	2,8	1,1	950	2,7	5,5	80,9	80,8	78,2	0,71	11	2,2	2,9	0,0041	21
HMA2 100L-6	1,75	1150	4,1	1,46	960	3,8	1,5	960	3,6	5,5	80,1	80,1	77,3	0,68	15	2,3	2,6	0,0085	26
HMA2 112M1-6	2,5	1150	5,4	2,13	960	5,4	2,2	960	5,2	5,9	83,6	83,8	81,7	0,71	22	2,3	2,8	0,013	35
HMA2 132S-6	3,5	1150	7,1	2,9	960	7,1	3,0	960	6,9	6,9	85,5	85,4	83,2	0,74	29	2,1	2,8	0,037	46
HMA2 132M1-6	4,7	1150	9,6	3,9	960	9,4	4,0	960	9,1	7,3	85,8	85,3	82,5	0,71	39	2,5	2,9	0,049	61
HMA2 132M2-6	6,4	1150	13	5,3	960	13	5,5	960	12,5	7,4	87,4	87,2	85,2	0,73	54	2,5	2,9	0,059	66

Cast iron motors

HMC2 80 1-6	0,43	1060	1,36	0,35	890	1,31	0,37	890	1,25	5,0	62	60	57	0,70	3,9	1,9	2,0	0,0016	17
HMC2 80 2-6	0,64	1060	1,85	0,53	890	1,8	0,55	890	1,7	5,0	65	63	60	0,72	5,8	1,9	2,0	0,0021	19
HMC2 90S-6	0,87	1090	2,2	0,73	910	2,0	0,75	910	2,0	5,9	75,9	75,7	72,8	0,72	7,5	2,0	2,1	0,0051	27
HMC2 90L-6	1,26	1090	3,0	1,07	910	3,0	1,1	910	2,8	5,9	78,1	77,9	75,2	0,73	11	2,0	2,1	0,0070	30
HMC2 100L-6	1,75	1125	3,8	1,46	940	3,8	1,5	940	3,8	5,9	79,8	79,6	77,1	0,74	15	2,0	2,1	0,013	39
HMC2 112M2-6	2,5	1125	5,6	2,13	940	5,4	2,2	940	5,4	6,9	81,8	81,7	79,3	0,74	22	2,0	2,1	0,021	54
HMC2 132S-6	3,5	1150	7,4	2,9	960	7,0	3,0	960	7,0	6,9	83,3	83,2	80,9	0,74	29	2,1	2,2	0,039	70
HMC2 132M1-6	4,7	1150	9,6	3,9	960	9,4	4,0	960	9,2	6,9	84,6	84,5	82,4	0,74	39	2,1	2,2	0,050	80
HMC2 132M2-6	6,4	1150	13	5,3	960	12,5	5,5	960	12,5	6,9	86,0	85,9	83,9	0,75	54	2,1	2,2	0,070	92
HMC2 160M-6	8,7	1165	17	7,3	970	16,5	7,5	970	16	6,7	87,2	87,1	84,3	0,78	74	2,1	2,3	0,093	123
HMC2 160L-6	12,8	1165	24	10,6	970	24	11	970	22	6,9	88,7	88,6	85,0	0,79	108	2,1	2,2	0,122	157
HMC2 180L-6	17,5	1165	31	14,5	970	31	15	970	30	7,2	89,7	89,3	86,7	0,81	146	2,0	2,2	0,217	206
HMC2 200L1-6	21,5	1165	38	17,9	970	38	18,5	970	36	7,2	90,4	90,5	88,2	0,81	180	2,1	2,2	0,331	243
HMC2 200L2-6	25,6	1175	44	21,3	980	44	22	980	42	7,3	90,9	90,9	88,5	0,82	214	2,1	2,2	0,378	256
HMC2 225M-6	34,9	1175	60	29,1	980	59	30	980	58	7,1	91,7	91,7	86,5	0,81	290	2,0	2,1	0,574	306
HMC2 250M-6	43	1175	72	35,9	980	71	37	980	69	7,1	92,2	92,2	88,1	0,84	360	2,1	2,2	0,876	416
HMC2 280S-6	52,4	1175	85	43,6	980	84	45	980	81	7,2	92,7	92,6	90,2	0,86	440	2,0	2,1	1,46	603
HMC2 280M-6	64	1175	104	53,3	980	102	55	980	99	7,5	93,1	93,1	92,4	0,86	535	2,0	2,1	1,73	693
HMC2 315S-6	87	1185	141	72,7	985	138	75	985	136	6,7	93,7	93,6	92,3	0,85	725	2,0	2,1	4,32	840
HMC2 315M-6	104	1185	168	87,3	985	164	90	985	160	6,7	94,0	94,1	92,6	0,84	870	2,0	2,1	5,02	1020
HMC2 315L1-6	128	1185	205	106	985	200	110	985	198	6,7	94,3	94,3	92,9	0,85	1060	2,0	2,1	5,73	1060
HMC2 315L2-6	153	1185	242	128	985	240	132	985	234	6,7	94,6	94,6	93,1	0,86	1280	2,0	2,1	6,43	1150
HMC2 355M1-6	186	1185	290	155	990	285	160	990	280	6,7	94,8	94,8	93,5	0,87	1545	2,0	2,1	10,9	1540
HMC2 355M2-6	232	1185	366	194	990	355	200	990	349	6,7	95,0	95,0	93,8	0,87	1935	2,0	2,0	13,0	1750
HMC2 355L-6	291	1185	453	242	990	445	250	990	436	7,3	95,0	95,0	93,8	0,87	2410	2,0	2,0	16,2	1860
HMC2 400M1-6	366	1185	585	305	990	560	315	990	545	7,0	95,2	95,2	94,6	0,88	3040	1,9	2,0	18,0	2220
HMC2 400M2-6	413	1185	660	344	990	630	355	990	615	7,0	95,3	95,3	94,7	0,88	3420	1,9	2,0	19,5	2500
HMC2 400L-6	465	1185	730	388	990	700	400	990	685	7,0	95,8	95,8	95,0	0,88	3860	1,9	2,0	21,8	2900

IE2 / 8 pol Marine

Motor type	440V 60Hz S1-45°C			380V 50Hz S1-45°C			400V 50Hz S1-40°C			Efficiency (%)			Pf	Torque			IM	Weight	
	P2	Speed	I _N	P2	Speed	I _N	P2	Speed	I _N	I _s /I _N	¹ / ₁ load	³ / ₄ load		¹ / ₂ load	cos φ	T _N			T _s /T _N
	kw	rpm	A	kw	rpm	A	kw	rpm	A										

Aluminium motors

HMA2 71 1-8	0,11	800	0,46	0,09	670	0,44	0,09	670	0,42	5,5	49	46	52	0,60	1,3	2,2	2,4	0,00044	6
HMA2 71 2-8	0,14	800	0,61	0,12	670	0,59	0,12	670	0,56	6,0	50	47	43	0,60	1,7	2,2	2,4	0,00055	6,5
HMA2 80 1-8	0,21	815	0,87	0,17	680	0,84	0,18	680	0,80	6,0	51	48	44	0,61	2,5	2,2	2,4	0,0014	9,5
HMA2 80 2-8	0,29	815	1,15	0,24	680	1,1	0,25	680	1,06	6,0	54	51	47	0,61	3,5	2,2	2,4	0,0019	12
HMA2 90S-8	0,43	820	1,5	0,35	690	1,47	0,37	690	1,4	6,0	62	60	57	0,61	5,1	2,2	2,4	0,0027	14
HMA2 90L-8	0,64	820	2,3	0,53	690	2,2	0,55	690	2,1	6,0	63	61	58	0,61	7,5	2,2	2,4	0,0035	17
HMA2 100L1-8	0,87	840	2,6	0,73	700	2,5	0,75	700	2,4	6,0	71	70	68	0,67	10	2,2	2,4	0,0067	23
HMA2 100L2-8	1,3	840	3,6	1,07	700	3,5	1,1	700	3,3	6,0	73	72	70	0,69	15	2,2	2,4	0,0078	26
HMA2 112M1-8	1,7	840	4,9	1,46	700	4,7	1,5	700	4,5	6,0	75	74	72	0,68	20	2,2	2,4	0,012	34
HMA2 132S-8	2,5	850	6,2	2,13	710	6,0	2,2	710	5,7	6,0	78	78	76	0,71	30	2,0	2,2	0,022	45
HMA2 132M-8	3,5	850	8,2	2,9	710	8,0	3,0	710	7,6	5,5	79	79	77	0,73	40	2,0	2,2	0,039	54

Cast iron motors

HMC2 80 1-8	0,21	750	0,92	0,17	630	0,88	0,18	630	0,84	5,0	51	48	44	0,61	2,5	1,8	1,9	0,0016	17
HMC2 80 2-8	0,29	760	1,2	0,24	640	1,15	0,25	640	1,1	5,0	54	51	47	0,61	3,5	1,8	1,9	0,0021	19
HMC2 90S-8	0,43	790	1,52	0,35	660	1,47	0,37	660	1,4	5,0	62	60	57	0,61	5,1	1,8	2,0	0,0029	23
HMC2 90L-8	0,64	790	2,3	0,53	660	2,2	0,55	660	2,1	5,0	63	61	58	0,61	7,5	1,8	2,0	0,0035	25
HMC2 100L1-8	0,87	820	2,5	0,73	690	2,4	0,75	690	2,3	5,0	71	70	68	0,67	10	1,8	2,0	0,0069	33
HMC2 100L2-8	1,3	820	3,4	1,07	690	3,3	1,1	690	3,15	5,0	73	72	70	0,69	15	1,8	2,0	0,011	38
HMC2 112M-8	1,7	815	4,6	1,46	680	4,4	1,5	680	4,2	5,0	75	74	72	0,69	20	1,8	2,0	0,015	50
HMC2 132S-8	2,5	850	6,2	2,13	710	6,0	2,2	710	5,7	7,0	78	78	76	0,71	30	1,8	2,0	0,031	63
HMC2 132M-8	3,5	850	8,2	2,9	710	7,9	3,0	710	7,5	7,0	79	79	77	0,73	40	1,8	2,0	0,040	79
HMC2 160M1-8	4,7	860	10,7	3,9	720	10,3	4,0	720	9,8	7,0	81	82	81	0,73	53	1,9	2,0	0,075	118
HMC2 160M2-8	6,4	860	14,2	5,3	720	13,7	5,5	720	13	7,0	83	84	83	0,74	73	1,9	2,0	0,093	119
HMC2 160L-8	8,7	860	18,5	7,3	720	17,9	7,5	720	17	7,0	86	87	87	0,75	100	1,9	2,0	0,13	145
HMC2 180L-8	12,8	870	26	10,6	730	25	11	730	24	7,0	88	89	88	0,76	144	1,9	2,0	0,20	172
HMC2 200L-8	17,5	870	36	14,5	730	35	15	730	33	7,0	88	89	88	0,76	196	1,9	2,0	0,34	236
HMC2 225S-8	21,5	870	43	17,9	730	35	18,5	730	39	7,0	90	91	90	0,76	242	1,9	2,0	0,49	292
HMC2 225M-8	25,6	890	49	21,3	740	47	22	740	45	7,0	90,5	91,3	90,5	0,78	288	1,9	2,0	0,55	302
HMC2 250M-8	34,9	890	65	29,1	740	63	30	740	60	7,0	91,0	91,6	90,8	0,79	390	1,9	2,0	0,83	396
HMC2 280S-8	43,1	890	81	35,9	740	78	37	740	74	7,0	91,5	92,0	91,5	0,79	485	1,9	2,0	1,4	520
HMC2 280M-8	52,4	890	98	43,6	740	95	45	740	90	7,0	92,0	92,5	92,0	0,79	590	1,9	2,0	1,7	533
HMC2 315S-8	64	890	116	53,3	740	111	55	740	106	7,0	92,8	93,1	92,9	0,81	715	1,8	2,0	4,8	1125
HMC2 315M-8	87	890	157	72,7	740	151	75	740	144	7,0	93,0	93,3	93,1	0,81	975	1,8	2,0	5,6	1250
HMC2 315L1-8	104	890	184	87,3	740	177	90	740	169	7,0	93,8	94,0	93,8	0,82	1170	1,8	2,0	6,4	1310
HMC2 315L2-8	128	890	225	106	740	216	110	740	206	7,0	94,0	94,2	94,0	0,82	1430	1,8	2,0	7,2	1350
HMC2 355M1-8	153	890	270	128	740	260	132	740	248	6,5	94,2	94,3	94,2	0,82	1705	1,8	2,0	11	1750
HMC2 355M2-8	186	890	326	155	740	314	160	740	299	6,5	94,5	94,7	94,6	0,82	2065	1,8	2,0	12	1880
HMC2 355L-8	232	890	401	194	740	386	200	740	368	6,5	95,0	95,1	94,9	0,83	2580	1,8	2,0	13	2060
HMC2 400M1-8	291	895	511	242	745	492	250	745	469	6,5	95,0	95,2	95,1	0,81	3225	1,8	2,0	25	3100
HMC2 400M2-8	325	895	572	271	745	551	280	745	525	6,5	95,0	95,1	95,1	0,81	3590	1,8	2,0	26	3200
HMC2 400L1-8	366	895	613	305	745	591	315	745	563	6,5	95,0	95,1	95,0	0,85	4040	1,8	2,0	28	3300
HMC2 400L2-8	413	895	717	344	745	690	355	745	658	7,0	95,0	95,1	95,0	0,82	4550	1,8	2,0	30	3400
HMC2 400L3-8	466	895	807	388	745	778	400	745	741	7,0	95,0	95,0	94,9	0,82	5130	1,8	2,0	31	3550

IE2 / B3 Marine

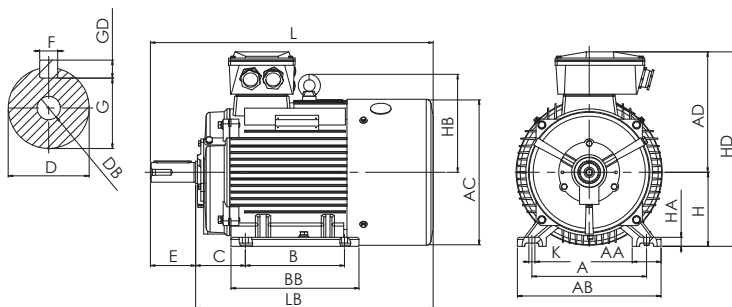

Motor type	Pole	A	AA	AB	AC	AD	B	BB	C	D	DB	E	F	G	GD	H	HA	HB	HD	K	L	LB
------------	------	---	----	----	----	----	---	----	---	---	----	---	---	---	----	---	----	----	----	---	---	----

Aluminum motors

HMA2 56	-	90	20	110	115	100	71	90	36	9	M4	20	3	7,2	3	56	7,5	-	156	5,8	195	175
HMA2 63	-	100	22	125	125	100	80	108	40	11	M4	23	4	8,5	4	63	9	-	163	7	215	192
HMA2 71	-	112	24	140	140	110	90	114	45	14	M5	30	5	11	5	71	9	-	181	7	246	216
HMA2 80	-	125	27	160	158	128	100	122	50	19	M6	40	6	15,5	6	80	12	-	208	10	290	250
HMA2 90S	-	140	35	175	175	132	100	155	56	24	M8	50	8	20	7	90	13	-	222	10	335	285
HMA2 90L	-	140	35	175	175	132	125	155	56	24	M8	50	8	20	7	90	13	-	222	10	361	311
HMA2 100L	-	160	42	205	197	147	140	176	63	28	M10	60	8	24	7	100	12	-	247	12	400	350
HMA2 112M1	-	190	45	222	220	169	140	180	70	28	M10	60	8	24	7	112	13	145	281	12	394	334
HMA2 112M2	-	190	45	222	220	169	140	180	70	28	M10	60	8	24	7	112	13	145	281	12	422	362
HMA2 132S	-	216	50	256	260	188	140	180	89	38	M12	80	10	33	8	132	16,5	165	320	12	462	382
HMA2 132M1	-	216	50	256	260	188	178	218	89	38	M12	80	10	33	8	132	16,5	165	320	12	500	420
HMA2 132M2	-	216	50	256	260	188	178	218	89	38	M12	80	10	33	8	132	16,5	165	320	12	525	445

Cast iron motors

HMC2 160M	-	254	65	320	316	277	210	260	108	42	M16	110	12	37	8	160	20	222	437	14,5	615	505
HMC2 160L	-	254	65	320	316	277	254	305	108	42	M16	110	12	37	8	160	20	222	437	14,5	670	560
HMC2 180M	-	279	70	355	356	297	241	315	121	48	M16	110	14	42,5	9	180	22	237	477	14,5	700	590
HMC2 180L	-	279	70	355	356	297	279	355	121	48	M16	110	14	42,5	9	180	22	237	477	14,5	740	630
HMC2 200L	-	318	70	395	396	321	305	375	133	55	M20	110	16	49	10	200	25	262	521	18,5	770	660
HMC2 200L1*	4	318	70	388	397	313	305	369	133	55	M20	110	16	46	10	200	25	263	513	18,5	769	660
HMC2 225S	4,6,8	356	75	435	446	346	286	375	149	60	M20	140	18	53	11	225	28	285	571	18,5	815	675
HMC2 225M	2	356	75	435	446	346	311	400	149	55	M20	110	16	49	10	225	28	285	571	18,5	820	710
	4,6,8	356	75	435	446	346	311	400	149	60	M20	140	18	53	11	225	28	285	571	18,5	845	705
HMC2 225M1*	2	356	75	431	463	347	311	393	149	55	M20	110	16	49	10	225	28	572	572	18,5	864	754
	4	356	75	431	463	347	311	393	149	60	M20	140	18	53	11	225	28	307	572	18,5	864	754
HMC2 250M	2	406	80	490	490	367	349	445	168	60	M20	140	18	53	11	250	30	316	617	24	915	775
	4,6,8	406	80	490	490	367	349	445	168	65	M20	140	18	58	11	250	30	316	617	24	915	775
HMC2 250M1*	2	406	80	484	500	390	349	450	168	60	M20	140	18	53	11	250	30	361	640	24	1015	875
	4	406	80	484	500	390	349	450	168	65	M20	140	18	58	11	250	30	361	640	24	1015	875
HMC2 280S	2	457	85	550	550	405	368	490	190	65	M20	140	18	58	11	280	35	345	685	24	985	845
	4,6,8	457	85	550	550	405	368	490	190	75	M20	140	20	67,5	12	280	35	345	685	24	985	845
HMC2 280M	2	457	85	550	550	405	419	540	190	65	M20	140	18	58	11	280	35	345	685	24	1035	895
	4,6,8	457	85	550	550	405	419	540	190	75	M20	140	20	67,5	12	280	35	345	685	24	1035	895
HMC2 280MB*	4	457	85	542	557	419	419	536	190	75	M20	140	20	67,5	12	280	35	417	699	24	1092	952
HMC2 315S	2	508	120	635	620	550	406	575	216	65	M20	140	18	58	11	315	45	430	865	28	1215	1075
	4,6,8	508	120	635	620	550	406	575	216	80	M20	170	22	71	14	315	45	430	865	28	1245	1075
HMC2 315M	2	508	120	635	620	550	457	685	216	65	M20	140	18	58	11	315	45	430	865	28	1325	1185
	4,6,8	508	120	635	620	550	457	685	216	80	M20	170	22	71	14	315	45	430	865	28	1355	1185
HMC2 315L	2	508	120	635	620	550	508	685	216	65	M20	140	18	58	11	315	45	430	865	28	1325	1185
	4,6,8	508	120	635	620	550	508	685	216	80	M20	170	22	71	14	315	45	430	865	28	1355	1185
HMC2 315L3*	4	508	120	628	620	556	508	680	216	80	M20	170	22	71	14	315	45	442	871	28	1458	1288
HMC2 355M	2	610	116	730	700	671	560	760	254	75	M20	140	20	67,5	12	355	52	490	1065	28	1515	1375
	4,6,8	610	116	730	700	671	560	760	254	95	M24	170	25	86	14	355	52	490	1065	28	1545	1375
HMC2 355L	2	610	116	730	700	671	630	760	254	75	M20	140	20	67,5	12	355	52	490	1065	28	1515	1375
	4,6,8	610	116	730	700	671	630	760	254	95	M24	170	25	86	14	355	52	490	1065	28	1545	1375
HMC2 400M	2	686	120	806	856	690	630	1090	280	80	M20	170	22	71	14	400	45	610	1090	35	1880	1710
	4,6,8	686	120	806	856	690	630	1090	280	110	M24	210	28	100	16	400	45	610	1090	35	1920	1710
HMC2 400L	2	686	120	806	856	690	710	1090	280	80	M20	170	22	71	14	400	45	610	1090	35	1880	1710
	4,6,8	686	120	806	856	690	710	1090	280	110	M24	210	28	100	16	400	45	610	1090	35	1920	1710

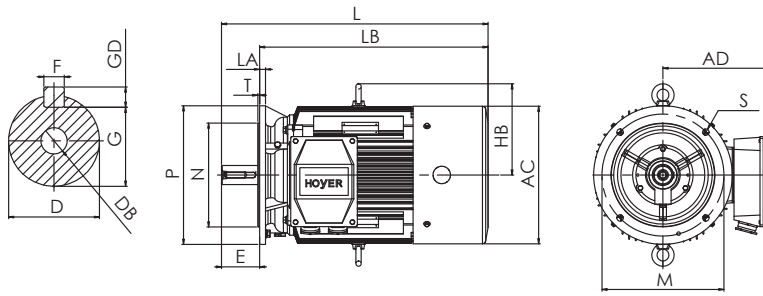

IE2 / B5
Marine

Motor type	Pole	AC	AD	D	DB	E	F	G	GD	HB	L	LA	LB	M	N	P	S	T
------------	------	----	----	---	----	---	---	---	----	----	---	----	----	---	---	---	---	---

Aluminum motors

HMA2 56	-	115	100	9	M4	20	3	7,2	3	-	195	7	175	100	80	120	4-Ø7	3
HMA2 63	-	125	100	11	M4	23	4	8,5	4	-	215	9	192	115	95	140	4-Ø10	3
HMA2 71	-	140	110	14	M5	30	5	11	5	-	246	10	216	130	110	160	4-Ø10	3,5
HMA2 80	-	158	128	19	M6	40	6	15,5	6	-	290	10	250	165	130	200	4-Ø12	3,5
HMA2 90S	-	175	132	24	M8	50	8	20	7	-	335	10	285	165	130	200	4-Ø12	3,5
HMA2 90L	-	175	132	24	M8	50	8	20	7	-	361	10	311	165	130	200	4-Ø12	3,5
HMA2 100L	-	197	147	28	M10	60	8	24	7	-	400	14	350	215	180	250	4-Ø15	4
HMA2 112M1	-	220	169	28	M10	60	8	24	7	145	394	14	334	215	180	250	4-Ø15	4
HMA2 112M2	-	220	169	28	M10	60	8	24	7	145	422	14	362	215	180	250	4-Ø15	4
HMA2 132S	-	260	188	38	M12	80	10	33	8	165	462	15	382	265	230	300	4-Ø15	4
HMA2 132M1	-	260	188	38	M12	80	10	33	8	165	500	15	420	265	230	300	4-Ø15	4
HMA2 132M2	-	260	188	38	M12	80	10	33	8	165	525	15	445	265	230	300	4-Ø15	4

Cast iron motors

HMC2 160M	-	316	277	42	M16	110	12	37	8	222	615	18	505	300	250	350	4-Ø18,5	5
HMC2 160L	-	316	277	42	M16	110	12	37	8	222	670	18	560	300	250	350	4-Ø18,5	5
HMC2 180M	-	356	297	48	M16	110	14	42,5	9	237	700	18	590	300	250	350	4-Ø18,5	5
HMC2 180L	-	356	297	48	M16	110	14	42,5	9	237	740	20	630	300	250	350	4-Ø18,5	5
HMC2 200L	-	396	321	55	M20	110	16	49	10	262	770	20	660	350	300	400	4-Ø18,5	5
HMC2 200L1*	4	397	313	55	M20	110	16	49	10	263	769	17	660	350	300	400	4-Ø18,5	5
HMC2 225S	4,6,8	446	346	60	M20	140	18	53	11	285	815	22	675	400	350	450	8-Ø18,5	5
HMC2 225M	2	446	346	55	M20	110	16	49	10	285	820	22	710	400	350	450	8-Ø18,5	5
	4,6,8	446	346	60	M20	140	18	53	11	285	845	22	705	400	350	450	8-Ø18,5	5
HMC2 225M1*	2	463	347	55	M20	110	16	49	10	307	864	20	754	400	350	450	8-Ø18,5	5
	4	463	347	60	M20	140	18	53	11	307	864	20	754	400	350	450	8-Ø18,5	5
HMC2 250M	2	490	367	60	M20	140	18	53	11	316	915	24	775	500	450	550	8-Ø18,5	5
	4,6,8	490	367	65	M20	140	18	58	11	316	915	24	775	500	450	550	8-Ø18,5	5
HMC2 250M1*	2	500	390	60	M20	140	18	53	11	361	1015	22	875	500	450	550	8-Ø18,5	5
	4	500	390	65	M20	140	18	58	11	361	1015	22	875	500	450	550	8-Ø18,5	5
HMC2 280S	2	550	405	65	M20	140	18	58	11	345	985	24	845	500	450	550	8-Ø18,5	5
	4,6,8	550	405	75	M20	140	20	67,5	12	345	985	24	845	500	450	550	8-Ø18,5	5
HMC2 280M	2	550	405	65	M20	140	18	58	11	345	1035	24	895	500	450	550	8-Ø18,5	5
	4,6,8	550	405	75	M20	140	20	67,5	12	345	1035	24	895	500	450	550	8-Ø18,5	5
HMC2 280MB*	4	557	419	75	M20	140	20	67,5	12	417	1092	22	952	500	450	550	8-Ø18,5	5
HMC2 315S	2	620	550	65	M20	140	18	58	11	430	1215	24	1075	600	550	660	8-Ø24	6
	4,6,8	620	550	80	M20	170	22	71	14	430	1245	24	1075	600	550	660	8-Ø24	6
HMC2 315M	2	620	550	65	M20	140	18	58	11	430	1325	24	1185	600	550	660	8-Ø24	6
	4,6,8	620	550	80	M20	170	22	71	14	430	1355	24	1185	600	550	660	8-Ø24	6
HMC2 315L	2	620	550	65	M20	140	18	58	11	430	1325	24	1185	600	550	660	8-Ø24	6
	4,6,8	620	550	80	M20	170	22	71	14	430	1355	24	1185	600	550	660	8-Ø24	6
HMC2 315L3*	4	620	556	80	M20	170	22	71	14	442	1458	22	1288	600	550	660	8-Ø24	6
HMC2 355M	2	700	671	75	M20	140	20	67,5	12	490	1515	25	1375	740	680	800	8-Ø24	6
	4,6,8	700	671	95	M24	170	25	86	14	490	1545	25	1375	740	680	800	8-Ø24	6
HMC2 355L	2	700	671	75	M20	140	20	67,5	12	490	1515	25	1375	740	680	800	8-Ø24	6
	4,6,8	700	671	95	M24	170	25	86	14	490	1545	25	1375	740	680	800	8-Ø24	6
HMC2 400M	2	856	690	80	M20	170	22	71	14	610	1880	25	1710	940	880	1000	8-Ø28	6
	4,6,8	856	690	110	M24	210	28	100	16	610	1920	25	1710	940	880	1000	8-Ø28	6
HMC2 400L	2	856	690	80	M20	170	22	71	14	610	1880	25	1710	940	880	1000	8-Ø28	6
	4,6,8	856	690	110	M24	210	28	100	16	610	1920	25	1710	940	880	1000	8-Ø28	6

*Motors with high power / small frame

IE2 / B14 Marine

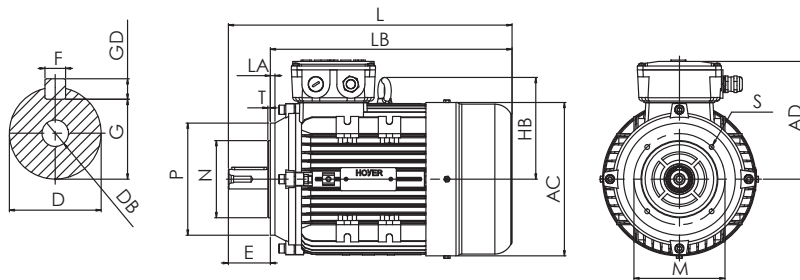

Motor type	AC	AD	D	DB	E	F	G	GD	HB	L	LB	B14A small or C DIN flange					B14B big				
												M	N	P	S	T	M	N	P	S	T

Aluminum motors

HMA2 56	115	100	9	M4	20	3	7,2	3	-	195	175	65	50	80	4-M5	2,5	-	-	-	-	-
HMA2 63	125	100	11	M4	23	4	8,5	4	-	215	192	75	60	90	4-M5	2,3	-	-	-	-	-
HMA2 71	140	110	14	M5	30	5	11	5	-	246	216	85	70	105	4-M6	2,5	115	95	140	4-M8	3
HMA2 80	158	128	19	M6	40	6	15,5	6	-	290	250	100	80	120	4-M6	3	130	110	160	4-M8	3,5
HMA2 90S	175	132	24	M8	50	8	20	7	-	335	285	115	95	140	4-M8	3	130	110	160	4-M8	3,5
HMA2 90L	175	132	24	M8	50	8	20	7	-	361	311	115	95	140	4-M8	3	130	110	160	4-M8	3,5
HMA2 100L	197	147	28	M10	60	8	24	7	-	400	350	130	110	160	4-M8	3,5	165	130	200	4-M10	4
HMA2 112M1	220	169	28	M10	60	8	24	7	145	394	334	130	110	160	4-M8	3,5	165	130	200	4-M10	4
HMA2 112M2	220	169	28	M10	60	8	24	7	145	422	362	130	110	160	4-M8	3,5	165	130	200	4-M10	4
HMA2 132S	260	188	38	M12	80	10	33	8	165	462	382	165	130	200	4-M10	4	-	-	-	-	-
HMA2 132M1	260	188	38	M12	80	10	33	8	165	500	420	165	130	200	4-M10	4	-	-	-	-	-
HMA2 132M2	260	188	38	M12	80	10	33	8	165	500	420	165	130	200	4-M10	4	-	-	-	-	-

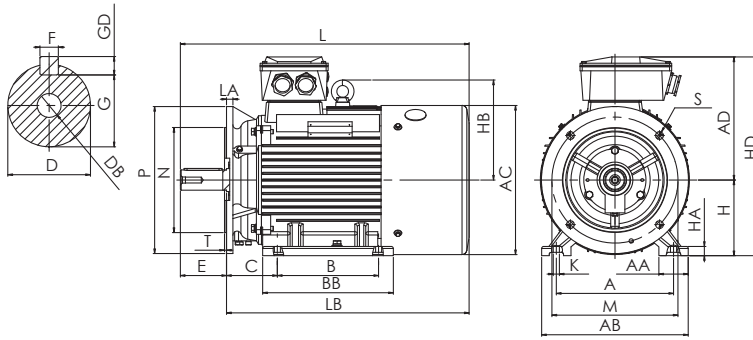

IE2 / B35
Marine

Motor type	Pole	A	AA	AB	AC	AD	B	BB	C	D	DB	E	F	G	GD	H	HA	HB	HD	K	L	LA	LB	M	N	P	S	T
------------	------	---	----	----	----	----	---	----	---	---	----	---	---	---	----	---	----	----	----	---	---	----	----	---	---	---	---	---

Aluminum motors

HMA2 56	-	90	20	110	115	100	71	90	36	9	M4	20	3	7,2	3	56	7,5	-	156	5,8	195	7	175	100	80	120	4-Ø7	3
HMA2 63	-	100	22	125	125	100	80	108	40	11	M4	23	4	8,5	4	63	9	-	163	7	215	9	192	115	95	140	4-Ø10	3
HMA2 71	-	112	24	140	140	110	90	114	45	14	M5	30	5	11	5	71	9	-	181	7	246	10	216	130	110	160	4-Ø10	3,5
HMA2 80	-	125	27	160	158	128	100	122	50	19	M6	40	6	15,5	6	80	12	-	208	10	290	10	250	165	130	200	4-Ø12	3,5
HMA2 90S	-	140	35	175	175	132	100	155	56	24	M8	50	8	20	7	90	13	-	222	10	335	10	285	165	130	200	4-Ø12	3,5
HMA2 90L	-	140	35	175	175	132	125	155	56	24	M8	50	8	20	7	90	13	-	222	10	361	10	311	165	130	200	4-Ø12	3,5
HMA2 100L	-	160	42	205	197	147	140	176	63	28	M10	60	8	24	7	100	12	-	247	12	400	14	350	215	180	250	4-Ø15	4
HMA2 112M1	-	190	45	222	220	169	140	180	70	28	M10	60	8	24	7	112	13	145	281	12	394	14	334	215	180	250	4-Ø15	4
HMA2 112M2	-	190	45	222	220	169	140	180	70	28	M10	60	8	24	7	112	13	145	281	12	422	14	362	215	180	250	4-Ø15	4
HMA2 132S	-	216	50	256	260	188	140	180	89	38	M12	80	10	33	8	132	16,5	165	320	12	462	15	382	265	230	300	4-Ø15	4
HMA2 132M1	-	216	50	256	260	188	178	218	89	38	M12	80	10	33	8	132	16,5	165	320	12	500	15	420	265	230	300	4-Ø15	4
HMA2 132M2	-	216	50	256	260	188	178	218	89	38	M12	80	10	33	8	132	16,5	165	320	12	525	15	445	265	230	300	4-Ø15	4

Cast iron motors

HMC2 160M	-	254	65	320	316	277	210	260	108	42	M16	110	12	37	8	160	20	222	437	14,5	615	18	505	300	250	350	4-Ø18,5	5
HMC2 160L	-	254	65	320	316	277	254	305	108	42	M16	110	12	37	8	160	20	222	437	14,5	670	18	560	300	250	350	4-Ø18,5	5
HMC2 180M	-	279	70	355	356	297	241	315	121	48	M16	110	14	42,5	9	180	22	237	477	14,5	700	18	590	300	250	350	4-Ø18,5	5
HMC2 180L	-	279	70	355	356	297	279	355	121	48	M16	110	14	42,5	9	180	22	237	477	14,5	740	20	630	300	250	350	4-Ø18,5	5
HMC2 200L	-	318	70	395	396	321	305	375	133	55	M20	110	16	49	10	200	25	262	521	18,5	770	20	660	350	300	400	4-Ø18,5	5
HMC2 200L1*	4	318	70	388	397	313	305	369	133	55	M20	110	16	49	10	200	25	263	513	18,5	769	17	660	350	300	400	4-Ø18,5	5
HMC2 225S	4,6,8	356	75	435	446	346	286	375	149	60	M20	140	18	53	11	225	28	285	571	18,5	815	22	675	400	350	450	8-Ø18,5	5
HMC2 225M1*	2	356	75	431	463	347	311	393	149	55	M20	110	16	49	10	225	28	307	572	18,5	864	20	754	400	350	450	8-Ø18,5	5
	4	356	75	431	463	347	311	393	149	60	M20	140	18	53	11	225	28	307	572	18,5	864	20	754	400	350	450	8-Ø18,5	5
HMC2 250M	2	406	80	490	490	367	349	445	168	60	M20	140	18	53	11	250	30	316	617	24	915	24	775	500	450	550	8-Ø18,5	5
	4,6,8	406	80	490	490	367	349	445	168	65	M20	140	18	58	11	250	30	316	617	24	915	24	775	500	450	550	8-Ø18,5	5
HMC2 250M1*	2	406	80	484	500	390	349	450	168	60	M20	140	18	53	11	250	30	361	640	24	1015	22	875	500	450	550	8-Ø18,5	5
	4	406	80	484	500	390	349	450	168	65	M20	140	18	58	11	250	30	361	640	24	1015	22	875	500	450	550	8-Ø18,5	5
HMC2 280S	2	457	85	550	550	405	368	490	190	65	M20	140	18	58	11	280	35	345	685	24	985	24	845	500	450	550	8-Ø18,5	5
	4,6,8	457	85	550	550	405	368	490	190	75	M20	140	20	67,5	12	280	35	345	685	24	985	24	845	500	450	550	8-Ø18,5	5
HMC2 280M	2	457	85	550	550	405	419	540	190	65	M20	140	18	58	11	280	35	345	685	24	1035	24	895	500	450	550	8-Ø18,5	5
	4,6,8	457	85	550	550	405	419	540	190	75	M20	140	20	67,5	12	280	35	345	685	24	1035	24	895	500	450	550	8-Ø18,5	5
HMC2 280MB*	4	457	85	542	557	419	419	536	190	75	M20	140	20	67,5	12	280	35	417	699	24	1092	22	952	500	450	550	8-Ø18,5	5
HMC2 315S	2	508	120	635	620	550	406	575	216	65	M20	140	18	58	11	315	45	430	865	28	1215	24	1075	600	550	660	8-Ø24	6
	4,6,8	508	120	635	620	550	406	575	216	80	M20	170	22	71	14	315	45	430	865	28	1245	24	1075	600	550	660	8-Ø24	6
HMC2 315M	2	508	120	635	620	550	457	685	216	65	M20	140	18	58	11	315	45	430	865	28	1325	24	1185	600	550	660	8-Ø24	6
	4,6,8	508	120	635	620	550	457	685	216	80	M20	170	22	71	14	315	45	430	865	28	1355	24	1185	600	550	660	8-Ø24	6
HMC2 315L	2	508	120	635	620	550	508	685	216	65	M20	140	18	58	11	315	45	430	865	28	1325	24	1185	600	550	660	8-Ø24	6
	4,6,8	508	120	635	620	550	508	685	216	80	M20	170	22	71	14	315	45	430	865	28	1355	24	1185	600	550	660	8-Ø24	6
HMC2 315L3*	4	508	120	628	620	556	508	680	216	80	M20	170	22	71	14	315	45	442	871	28	1458	22	1288	600	550	660	8-Ø24	6
HMC2 355M	2	610	116	730	700	671	560	760	254	75	M20	140	20	67,5	12	355	52	490	1065	28	1515	25	1375	740	680	800	8-Ø24	6
	4,6,8	610	116	730	700	671	560	760	254	95	M24	170	25	86	14	355	52	490	1065	28	1545	25	1375	740	680	800	8-Ø24	6
HMC2 355L	2	610	116	730	700	671	630	760	254	75	M20	140	20	67,5	12	355	52	490	1065	28	1515	25	1375	740	680	800	8-Ø24	6
	4,6,8	610	116	730	700	671	630	760	254	95	M24	170	25	86	14	355	52	490	1065	28	1545	25	1375	740	680	800	8-Ø24	6
HMC2 400M	2	686	120	806	856	690	630	1090	280	80	M20	170	22	71	14	400	45	610	1090	35	1880	25	1710	940	880	1000	8-Ø28	6
	4,6,8	686	120	806	856	690	630	1090	280	110	M24	210	28	100	16	400	45	610	1090	35	1920	25	1710	940	880	1000	8-Ø28	6
HMC2 400L	2	686	120	806	856	690	710	1090	280	80	M20	170	22	71	14	400	45	610	1090	35	1880	25	1710	940	880	1000	8-Ø28	6
	4,6,8	686	120	806	856	690	710	1090	280	110	M24	210	28	100	16	400	45	610	1090	35	1920	25	1710	940	880	1000	8-Ø28	6

*Motors with high power / small frame

Bearings and Cable Glands

Bearings

Motor type	Drive end		None drive end	
	2 pole	4,6,8 pole	2 pole	4,6,8 pole
HMA2 56	6201-ZZ/C3		6201-ZZ/C3	
HMA2 63	6201-ZZ/C3		6201-ZZ/C3	
HMA2 71	6202-ZZ/C3		6202-ZZ/C3	
HMA2 80	6204-ZZ/C3		6204-ZZ/C3	
HMA2 90	6205-ZZ/C3		6204-ZZ/C3	
HMA2 100	6206-ZZ/C3		6206-ZZ/C3	
HMA2 112	6306-ZZ/C3		6306-ZZ/C3	
HMA2 132	6308-ZZ/C3		6308-ZZ/C3	
HMC2 160	6309-ZZ/C3		6309-ZZ/C3	
HMC2 180	6311-ZZ/C3		6311-ZZ/C3	
HMC2 200	6312-ZZ/C3		6312-ZZ/C3	
HMC2 200L1*		6212-ZZ/C3		6212-ZZ/C3
HMC2 225	6312-ZZ/C3	6313-ZZ/C3		6312-ZZ/C3
HMC2 225M1*	6313-ZZ/C3	6314-ZZ/C3		6313-ZZ/C3
HMC2 250	6313/C3	6314/C3		6313/C3
HMC2 250M1*	6314/C3	6315/C3		6314/C3
HMC2 280	6314/C3	6317/C3		6314/C3
HMC2 280MB*		6317/C3		6317/C3
HMC2 315	6317/C3	6319/C3	6317/C3	6319/C3
HMC2 315L3*		6319/C3		6319/C3
HMC2 355	6319/C3	6322/C3	6319/C3	6322/C3
HMC2 400	6322/C3	6326/C3	6322/C3	6326/C3

*Motors with high power / small frame

Cable glands

Motor type	Cable glands	Blind caps
HMA2 56	1 x M20x1,5	1 x M20x1,5
HMA2 63	1 x M20x1,5	1 x M20x1,5
HMA2 71	1 x M20x1,5	1 x M20x1,5
HMA2 80	1 x M20x1,5	1 x M20x1,5
HMA2 90	1 x M20x1,5	1 x M20x1,5
HMA2 100	1 x M20x1,5	1 x M20x1,5
HMA2 112	1 x M20x1,5	1 x M20x1,5
HMA2 132	2 x M25x1,5	1 x M20x1,5
HMC2 160	2 x M40x1,5	2 x M20x1,5
HMC2 180	2 x M40x1,5	2 x M20x1,5
HMC2 200	2 x M50x1,5	2 x M20x1,5
HMC2 225	2 x M50x1,5	2 x M20x1,5
HMC2 250	2 x M63x1,5	2 x M20x1,5
HMC2 280	2 x M63x1,5	2 x M20x1,5
HMC2 315	2 x M63x1,5	2 x M20x1,5
HMC2 355	2 x M72x2,0	2 x M20x1,5
HMC2 400	2 x M80x2,0	2 x M20x1,5

Rating plate

IE2		HOYER		CE	
www.hoyermotors.com					
Type: HMC2 280M-4		Serial No: SH984762-123		3~Motor	
D.E. 6317	N.D.E 6314		668Kg	IP55	Ins.cl. F
V. Δ / Y	Hz	KW	rpm	A. Δ / Y	Cos φ
400/690	50	90	1480	156/90	0,88
Δ 380	50	87,3	1480	Δ 162	0,88
Δ 440	60	104	1775	Δ 166	0,88
IE2 eff. at: 400/690V 50Hz		1/1: 94.2%	3/4: 94.5%	1/2: 92.7%	
IM: B5	Year: 2012	Tropical windings		IEC 60034-1	

Rating table amb. temp.

Amb. temp.	30°C	35°C	40°C	45°C	50°C	55°C	60°C
P/P _N	1,05	1,02	1,00	0,97	0,93	0,87	0,82

Workshop

In combination with the wide-ranging stock our highly skilled and certified workshop secures the most flexible stock in the business. Among other things the options for rebuild includes:

- Anti condensation heating
- ATEX Zone 22 / 2 (ExnA)
- Special bearings
- SPM nipples
- Forced fan cooling
- Pt100 built in thermo sensors
- Balancing class "A" or "B" (IEC60034-14)
- IP56, IP65 and IP66
- TENV (IC410) for mounting on open deck
- Encoders



Extras

Due to the shared facilities with Hoyer Transmissions we are able to provide an unique combination of extras:

- Pulleys
- Taper locks
- Belts
- Motor slides and rails
- Couplings
- Locking elements



Design and Approvals

Hoyer Marine electric Motors are type or design approved by several major international marine classification societies.

Germanischer Lloyd



Bureau Veritas



American Bureau of Shipping



Furthermore, Hoyer Marine electric motors can be supplied with certificates from all other major marine classification societies.

RINA



RMRS



NKK



CCS



LRS



DNV



KR



Mounting Positions

B6

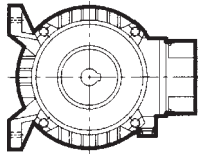

B3

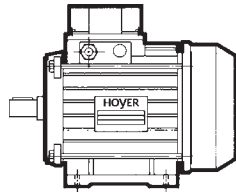

B5

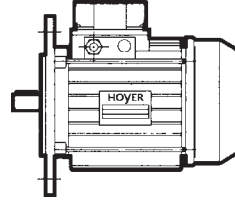

B14

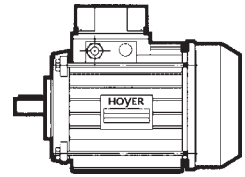

B7

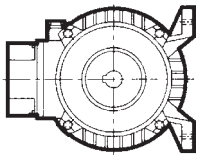

V5

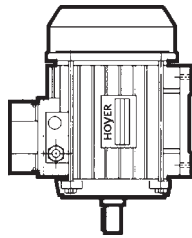

V1

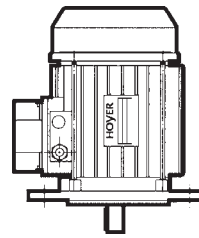

V18

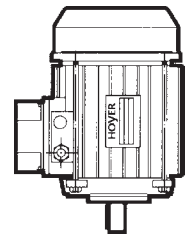

B8

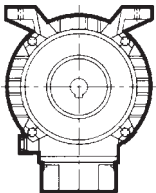

V6

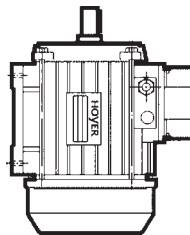

V3

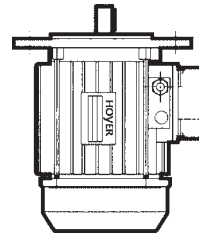

V19

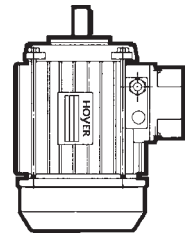

B3/B5

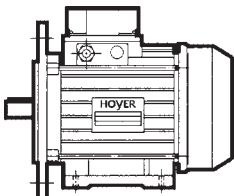

B3/B14

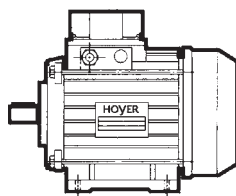

V1/V5

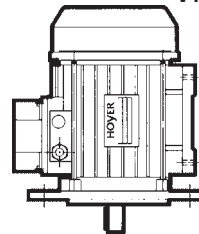

V3/V6

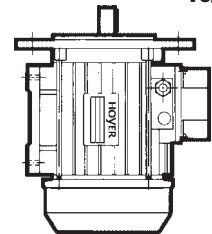

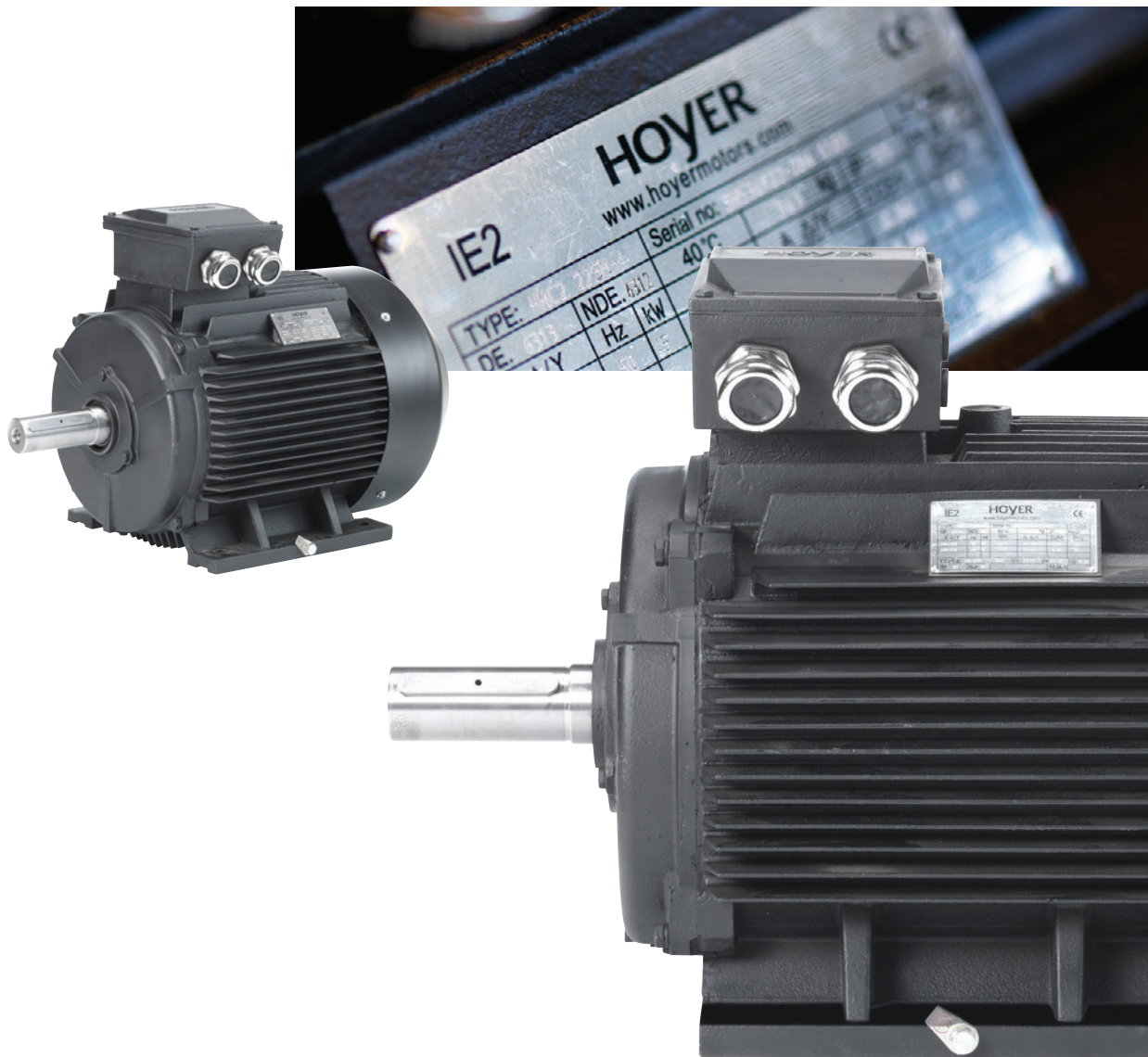

HOYER

EXCEEDING EXPECTATIONS

Hoyer Motors, IE2 Marine Motors, March 2014

Head Offices

Denmark
 Over Hadstensevej 42 · DK-8370 Hadsten
 T +45 86 98 21 11 · F +45 86 98 17 79
 hoyermotors@hoyermotors.com
 hoyermotors.com

China

19 Jingwu Middle Road · Beilun District
 Ningbo 315821 · Zhejiang
 T +86 574 26 28 15 77 · F + 86 574 2628 1573
 hoyermotors@hoyermotors.cn
 hoyermotors.cn

Branch Offices

Germany
 Landsberger Straße 155 · 80687 München
 T +49 89 700 88 235 · F +49 89 543 56 333
 germany@hoyermotors.com
 hoyermotors.com

Sweden

Liljeholmsvägen 30 · PO box 44017
 SE-100 73 Stockholm
 T +46 702 11 88 49
 sweden@hoyermotors.com
 hoyermotors.com

Benelux

Vasteland 78 · 3011 BN, Rotterdam
 Tel. +31 10 420 35 20 · Fax.+31 10 420 44 51
 benelux@hoyermotors.com
 hoyermotors.com

Korea

118dong 205ho · Busan T-Plex, 3153-1
 Daejeo 2-dong · Gangseo-gu · Busan · Korea
 T +82 51 996 0251 · F +82 51 996 0252
 korea@hoyermotors.com
 hoyermotors.com