

**Schischek Explosionproof.**  
*Protection of Life. Health. Assets.*

2 0 1 5

Technical short information 2015



## Schischek Global Coverage

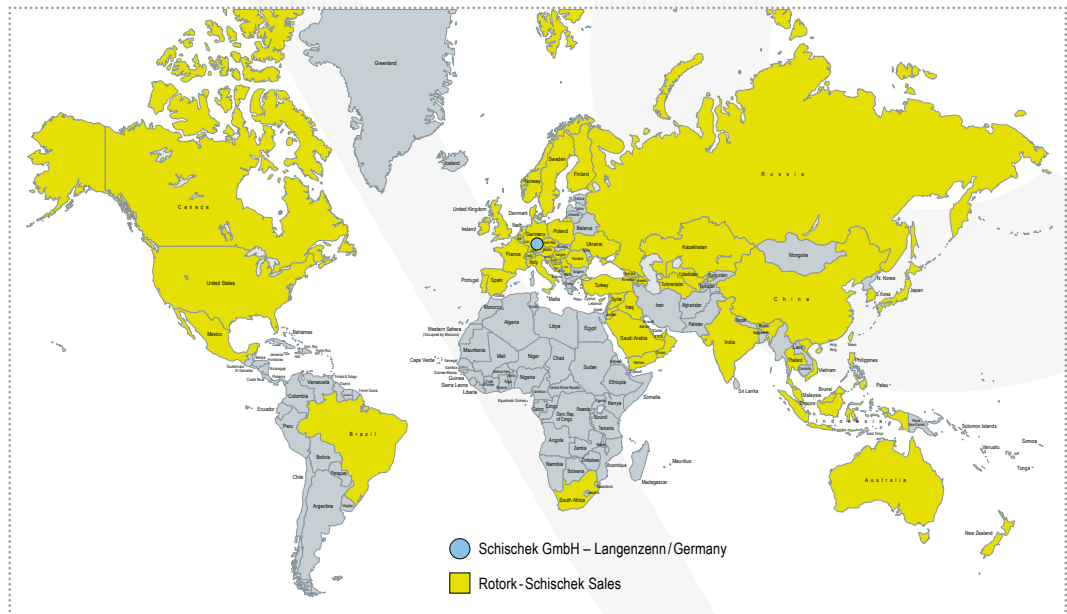

### Headquarter / Manufacturing

Schischek GmbH  
Mühlsteig 45  
Gewerbegebiet Süd 5  
90579 Langenzenn  
Germany  
Tel. +49 9101 9081-0  
Fax +49 9101 9081-77  
info-de@schischek.com  
www.schischek.com

### Schischek contact worldwide:

[www.schischek.com/contact/schischek-worldwide](http://www.schischek.com/contact/schischek-worldwide)  
[www.rotork.com/en/contact/index/](http://www.rotork.com/en/contact/index/)

# Safety, worldwide, in thousands of applications!

## Explosion protection since 1975

Since 1975 Schischek has supplied electric explosion proof products worldwide for heating, ventilation and air-conditioning, for industrial and offshore applications. Schischek Explosionproof has become an important partner for consultants, public authorities, control companies, installers, OEM's and, not least of all, the end user.

As supplier of components, we have always considered it our duty to develop products in conjunction with other control equipment. Modern Ex equipment, reliable, proven and with "state of the art" technology.

## Safety is essential

With this motto we state that explosion protection is not a question of statistics or half hearted solutions but that 100% safety must be guaranteed at all times. Explosion protection means taking on responsibility.

### "There is no little ex-protection!"

People have confidence in us as Ex protection specialists and in you as consultant, installer and contractor. All Schischek Ex products are, therefore, type-examination certified, approved by and produced according to the very latest standards and regulations. According to type and kind of protection, our products are suitable for operation in Ex areas, zones 0, 1, 2, 20, 21 and 22, including gases, vapours, mists and dusts – of course in accordance with ATEX 94/9/EC.

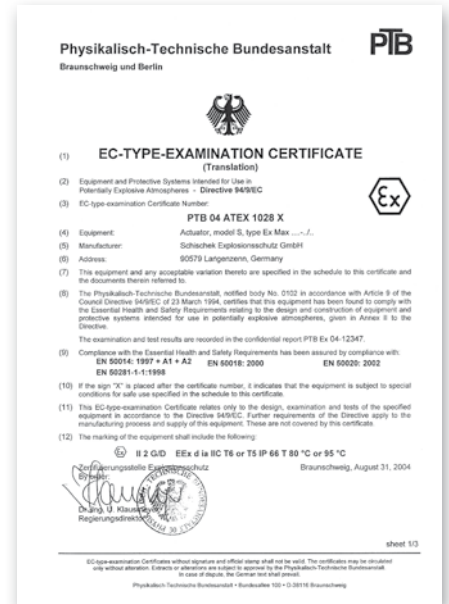

Heating, Ventilation, Air-Conditioning

Schischek supplies control companies and contractors in the Building Automation market. We have developed equipment which is compatible with nearly all control systems. By combining Schischek products with conventional switching and control equipment, reliable high quality systems are implemented that conform to Ex protection standards. Some examples of use are

fire and smoke dampers, paintspray areas, exhaust systems in chemical laboratories, battery rooms, sewage treatment plants, pumping stations etc.



Offshore, Onshore, Shipbuilding

Harsh environmental conditions and robust quality cause stringent design / construction requirements on components and materials. A fast closing electric actuator for fire / smoke dampers of less than 3 seconds is a requirement on oil and gas platforms as well as on FPSO's. After an intense development process including trials, a completely new concept in actuator engineering was produced. Since, thousands of

Schischek actuators in special aluminium, C5-M and stainless steel housings have been delivered and installed, moreover, the product range has been continuously enlarged and refined.



Chemical, Pharmaceutical, Car Industries

Whether you need air flow control in a pharmaceutical plant or temperature regulation of paint tanks in the car industry, Schischek offers cost-effective solutions specifically designed for control integration. Ex protection is required for applications from paint spray shops to drying stations. System compatibility with all aspects of control facilitates integrated planning from design to

completion. At the same time, safety and reliability increase in planning, installation, approval and operation. Since all equipment is maintenance-free, cost savings are realised.



Water Treatment Plants, Compressor Stations

In co-operation with valve and damper manufacturers, industrial control companies and contractors, Schischek products are in use worldwide. Our products are characterised by the "highest protection class, compact size and easy handling".

We can provide solutions to problems as far as Ex ventilation and precise temperature control in industrial plants are concerned.

## Which components have to be explosion proof?

In the diagram below, a typical air-handling system shows which equipment is allowed in the Ex area and which should only be placed in the safe area. The diagram does not claim to be complete.

If in doubt, please do not hesitate to consult us at Schischek. We will advise you in any case. A brief discussion in the early stages of planning can avoid substantial costs in remedial work later and gives you the peace of mind that you have a safely installed operating system.

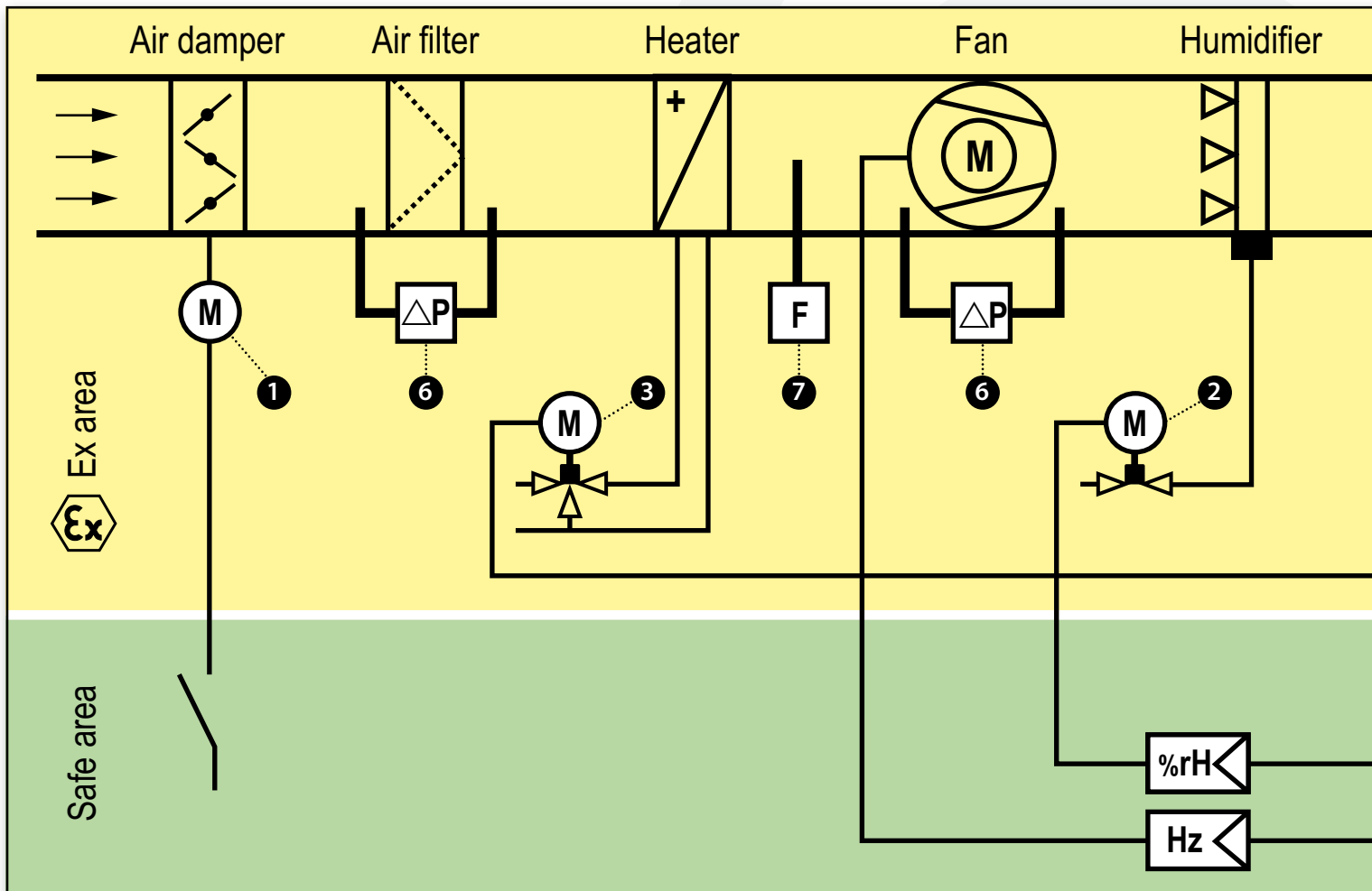

**1**

Quarter turn actuators for dampers and valves

**ExMax**  
**RedMax**

- 5...150 Nm
- 3...150 sec/90°
- On-off, 3-pos
- modulating
- with/without spring return

**2**

Failsafe linear valve actuators

**ExMax + LIN**  
**RedMax + LIN**

- 500...3.000 N
- 7,5...42 mm stroke
- 0,1...15 sec/mm
- On-off, 3-pos
- modulating
- with spring return

**3**

Linear valve actuators

**ExRun**  
**RedRun**

- 500...10.000 N
- 5...60 mm stroke
- 2...15 sec/mm
- On-off, 3-pos
- modulating

**4**

Temperature and humidity sensors

**ExCos-D**  
**RedCos-D**

- -40°C...+125°C
- 0...100 %rH
- full range adjustable

You should be aware of the areas of installation where an explosive atmosphere may build up. Furthermore, you should have the responsible authority classify the relevant Ex zone and in combination with type and condition of the explosive medium, you should be able to select suitable explosion proof equipment.

With Schischek products this is simple because all equipment is certified according to the highest safety standards – according to ATEX, of course!

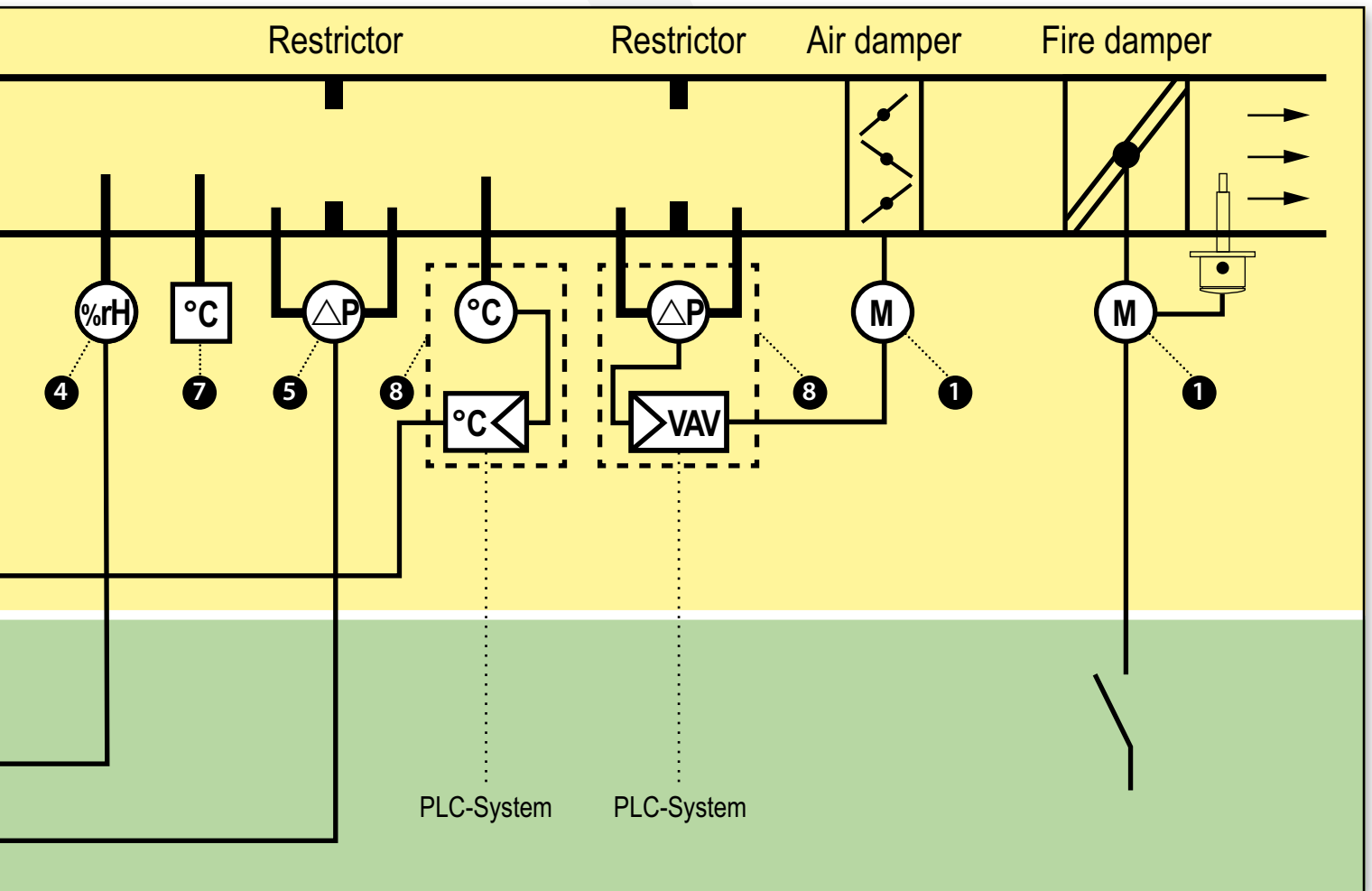

5

Pressure/differential pressure sensors

ExCos-P  
RedCos-P



- $\pm 100 \dots \pm 7.500$  Pa
- full range adjustable

6

Filter monitoring, fan belt protection

ExBin-P  
RedBin-P



- 0...5.000 Pa
- Pressure/Differential pressure
- Fan-belt protection
- Filter protection
- 1- or 2-stage switching point

7

Thermostats, humidistats, Frost protection

ExBin-D  
RedBin-D



- $-40^{\circ}\text{C} \dots +125^{\circ}\text{C}$
- 0...100 %rH
- 1- or 2-stage

ExBin-FR  
RedBin-FR

- $-10^{\circ}\text{C} \dots +15^{\circ}\text{C}$
- Capillary: 3 m, 6 m
- 1-stage switching point

8

Controller

ExReg-V  
Differential pressure

- 0...300 Pa (VAV)



ExReg-D  
Temperature/Humidity

- $-40^{\circ}\text{C} \dots +125^{\circ}\text{C}$
- 0...100 %rH



## Table of contents

Product series	Page
<b>Door holder magnets</b>	
ExMag door holder magnets with 650, 1.300, 2.000 N force	54
<b>Components</b>	
ExComp different Ex-components, e.g. switches, push buttons, ...	54
<b>Additional information</b>	
Product codes / definitions	56-57
Installation according to ATEX (Zone system)	58
Installation according to NEC 500 (Division system, North America)	59
Valve automation	60-61
Certification information	62-63
Information about ATEX 94/9/EC	64
Labelling of explosion proof equipment according to ATEX	65
Explosion proof informations	66
Information about zones, explosion groups and temperature classes	67
Ex applications	68
Notices	69
Rotork products	70-73
<b>NEW</b> Damper actuation focused	74-75

Installation areas in zone						
Gas	Dust	Gas	Dust	Gas	Dust	
0	20	1	21	2	22	SA*
		●	●	●	●	
		●	●	●	●	

\*SA = Safe area  
 (●) = on request

## Introducing ExMax – Damper actuators for hazardous locations!

Quarter turn and rotary applications for damper control ...

HAZARDOUS LOCATIONS ZONE 1, 2, 21, 22

FAST SPRING RETURN TIME

UNIVERSAL POWER SUPPLY

STAINLESS STEEL SOLUTION

C5-M OFFSHORE VERSION

EASY INSTALLATION

COMPACT DIMENSIONS





## ..Max Electrical drive engineering with 90° angle of rotation – Overview

### Overview ..Max quarter turn actuators

**Installation areas:**

**ExMax-** .....actuators for use in hazardous areas zone 1, 2, 21, 22

**RedMax-** .....actuators for use in hazardous areas zone 2, 22

**InMax-** .....actuators for use in safe area

**Application areas:**

**Ex/Red/InMax** ..... for air and fire dampers, VAV control, ball valves, control dampers, ...

**The actuator concept offers obvious advantages:**

1. Small dimension, compact, easy installation, highest protection classes, cost effective
2. Universal power supply 24 to 240 Volt AC/DC, selfadjustable
3. With or without spring return (in acc. with type)
4. Robust aluminium housing, IP66, optional in stainless steel
5. Integrated heater for low temperatures
6. On site adjustable motor running time
7. Application also possible into harsh environment (with stainless steel or C5-M versions)
8. Integrated manual override
9. Useful accessories such as retrofit limit switches
10. Actuators are direct coupling

#### Actuators for air-dampers

Nm ExMax



normal wiring



**ExMax..., RedMax..., InMax.. ¼ turn actuators**

90° actuators from 5 to 150 Nm, with or w/o spring return (running time 1, 3, 10, 20 s depending on type), for air-dampers.

#### Actuators for smoke- and fire-dampers

Nm ExMax



normal wiring



**ExMax..., RedMax..., InMax.. ¼ turn actuators**

90° actuators from 5 to 150 Nm, with or w/o spring return (running time 1, 3, 10, 20 s depending on type), for smoke- and fire-dampers.

#### Actuators for VAV control

Nm ExMax



normal wiring



**ExMax..., RedMax..., InMax.. ¼ turn actuators**

90° actuators from 5 to 150 Nm, with or w/o spring return (running time 1, 3, 10, 20 s depending on type), for VAV control.

#### Actuators for ball valves

Nm ExMax



normal wiring



**ExMax..., RedMax..., InMax.. ¼ turn actuators**

90° actuators from 5 to 150 Nm, with or w/o spring return (running time 1, 3, 10, 20 s depending on type), for ball valves.

#### Actuators for butterfly valves and other ¼ turn valves

Nm ExMax



normal wiring



**ExMax..., RedMax..., InMax.. ¼ turn actuators**

90° actuators from 5 to 150 Nm, with or w/o spring return (running time 1, 3, 10, 20 s depending on type), for butterfly valves and other quarter turn valves.

Safe area

Ex area

## ExMax 90° Ex quarter turn actuators size "S" for zone 1, 2, 21, 22

### Explosion proof

### Features of ExMax - ... size S

ExMax-...	Size S	Description	Basics for all ExMax-.. size S
Zone 1, 2, 21, 22 Gas + Dust certified according ATEX, IECEx, GOST-R, RTN, INMETRO, KOSHA UL*, CSA*, *...A version only		ExMax are, in acc. with type, for automation of air dampers, fire and smoke dampers, volume control, as well as for ball valves, throttle valves and other quarter turn armatures.  <b>Delivery:</b> 1 actuator, ~ 1 m cable, allen key for manual override, 4 screws.	<ul style="list-style-type: none"> <li>• 24...240 VAC/DC self adaptable power supply</li> <li>• Up to 5 different running times adjustable on site</li> <li>• 95°angle of rotation (5° for pretension)</li> <li>• 100% overload protected</li> <li>• Aluminium housing IP66, cable ~ 1 m</li> <li>• -40...+40°C/+50°C, integrated heater</li> <li>• Emergency manual override</li> <li>• Squared shaft connection 12 x 12 mm</li> <li>• Dimensions (H x W x D) 210 x 95 x 80 mm</li> </ul>

## Ex-d quarter turn actuators without spring return, 24 to 240 VAC/DC, for zone 1, 2, 21, 22

Type	Torque	Running time 90°	Spring return	Control mode	Feedback	Features	Size
ExMax- 5.10	5 Nm / 10 Nm	3/15/30/60/120 sec.	-	On-off, 3-pos	-	-	S
ExMax-15.30	15 Nm / 30 Nm	3/15/30/60/120 sec.	-	On-off, 3-pos	-	-	S
ExMax- 5.10-S	5 Nm / 10 Nm	3/15/30/60/120 sec.	-	On-off, 3-pos	2 x aux. switches (5°/85°)	-	S
ExMax-15.30-S	15 Nm / 30 Nm	3/15/30/60/120 sec.	-	On-off, 3-pos	2 x aux. switches (5°/85°)	-	S
ExMax- 5.10-Y	5 Nm / 10 Nm	7,5/15/30/60/120 sec.	-	3-pos, 0...10 VDC, 4...20 mA	0...10 VDC, 4...20 mA	-	S
ExMax-15.30-Y	15 Nm / 30 Nm	7,5/15/30/60/120 sec.	-	3-pos, 0...10 VDC, 4...20 mA	0...10 VDC, 4...20 mA	-	S

## Ex-d quarter turn actuators with spring return, 24 to 240 VAC/DC, for zone 1, 2, 21, 22

Type	Torque	Running time 90°	Spring return	Control mode	Feedback	Features	Size
ExMax-5.10- F	5 Nm / 10 Nm	3/15/30/60/120 sec.	~ 3 sec. / 10 sec.	On-off, 3-pos	-	-	S
ExMax- 15- F	15 Nm	3/15/30/60/120 sec.	~ 3 sec. / 10 sec.	On-off, 3-pos	-	-	S
ExMax-5.10-SF	5 Nm / 10 Nm	3/15/30/60/120 sec.	~ 3 sec. / 10 sec.	On-off, 3-pos	2 x aux. switches (5°/85°)	-	S
ExMax- 15-SF	15 Nm	3/15/30/60/120 sec.	~ 3 sec. / 10 sec.	On-off, 3-pos	2 x aux. switches (5°/85°)	-	S
ExMax-5.10-YF	5 Nm / 10 Nm	7,5/15/30/60/120 sec.	~ 3 sec. / 10 sec.	3-pos, 0...10 VDC, 4...20 mA	0...10 VDC, 4...20 mA	-	S
ExMax- 15-YF	15 Nm	7,5/15/30/60/120 sec.	~ 3 sec. / 10 sec.	3-pos, 0...10 VDC, 4...20 mA	0...10 VDC, 4...20 mA	-	S
ExMax-5.10-BF	5 Nm / 10 Nm	3/15/30/60/120 sec.	~ 3 sec. / 10 sec.	On-off, 3-pos	2 x aux. switches (5°/85°)	ExPro-TT... connector	S
ExMax- 15-BF	15 Nm	3/15/30/60/120 sec.	~ 3 sec. / 10 sec.	On-off, 3-pos	2 x aux. switches (5°/85°)	ExPro-TT... connector	S

## Ex-d quarter turn actuators with 1 sec. spring return for Offshore application, 24 to 240 VAC/DC, for zone 1, 2, 21, 22

Type	Torque	Running time 90°	Spring return	Control mode	Feedback	Features	Size
ExMax- 8- F1	8 Nm	3/15/30/60/120 sec.	≤ 1 sec.	On-off	-	-	S
ExMax-15- F1	15 Nm	3/15/30/60/120 sec.	≤ 1 sec.	On-off	-	-	S
ExMax- 8-SF1	8 Nm	3/15/30/60/120 sec.	≤ 1 sec.	On-off	2 x aux. switches (5°/85°)	-	S
ExMax-15-SF1	15 Nm	3/15/30/60/120 sec.	≤ 1 sec.	On-off	2 x aux. switches (5°/85°)	-	S
ExMax- 8-BF1	8 Nm	3/15/30/60/120 sec.	≤ 1 sec.	On-off	2 x aux. switches (5°/85°)	ExPro-TT... connector	S
ExMax-15-BF1	15 Nm	3/15/30/60/120 sec.	≤ 1 sec.	On-off	2 x aux. switches (5°/85°)	ExPro-TT... connector	S

## Accessories

Type	Technical data
ExSwitch	External, adaptable, on site adjustable Ex-d auxiliary switch with 2 potential free contacts, adaptable to ExMax-... actuators
ExBox-3P	Ex-e terminal box connectable to ExMax-... actuators with 1 cable for On-off or 3-pos operation
ExBox-3P/SW	Ex-e terminal box connectable to ExMax-... actuators with 1 cable for On-off or 3-pos operation + 2 cable for external aux. switches type ExSwitch
ExBox-Y/S	Ex-e terminal box connectable to ExMax-... actuators with 2 cable, for modulating operation or 3-pos + integrated switches (HS)
ExBox-Y/S/SW	Ex-e terminal box connectable to ExMax-... actuators with 2 cable, for modulating or 3-pos operation with feedback signal + 2 cable for external aux. switches
ExBox-BF	Ex-e terminal box connectable to ExMax-... actuators with 1 cable, for all ExMax-...-BF
ExBox-BF/SW	Ex-e terminal box connectable to ExMax-... actuators with 1 cable, for all ExMax-...-BF + 2 cable for external aux. switches type ExSwitch
MKK-S	Mounting bracket for ...Box-terminal boxes for direct coupling to ...Max... actuators size S
KB-S	Mounting clamp for round damper shaft Ø 10 to 20 mm and squared shafts 10 to 16 mm, incl. bracket, connectable to all ExMax-... size S
KB-A	Shaft connection for damper shafts Ø ½ ", adaptable for all North American ..Max-... actuators size S
HV-SK, HV-SL	Manual override, connectable to actuators size S. HV-SK = short version, HV-SL = long version for add. mounting of ..Box/ ..Switch (not suitable for ..Max-...-F1!)
AR-12-xx	Squared reduction part from 12 x 12 mm to shafts with 11 mm (type AR-12-11), 10 mm (type AR-12-10), 8 mm (type AR-12-08)
ExPro-TT-...	Safety temperature trigger for fire dampers, switching at 71°/72°C, with 1 m cable, suitable only for ExMax-/RedMax-...-BF actuators!
EXC-DS1/VA	Safety temperature sensor for duct mounting, potential free contact, switching at 70°C...160°C (10°C steps)
DWB-S	Angle rotation limiter for mounting on actuator size S (details on request)
Retrofit-Kit-S	Mechanical adaptation for mounting on ..Max actuators size S, required to replace a previous type EXT15...-F1, EXT12...-F16, EXT15... or EXT30..

Special options and offshore kits see page 23

## ExMax 90° Ex quarter turn actuators size "M" for zone 1, 2, 21, 22

Explosion proof

Features of ExMax - ... size M

ExMax-...	Size M	Description	Basics for all ExMax-.. size M
Zone 1, 2, 21, 22 Gas + Dust certified according ATEX, IECEx, GOST-R, RTN, INMETRO UL*, CSA*, *...-A version only		ExMax are, in acc. with type, for automation of air dampers, fire and smoke dampers, volume control, as well as for ball valves, throttle valves and other quarter turn armatures.  <b>Delivery:</b> 1 actuator, ~ 1 m cable, allen key for manual override, 4 screws.	<ul style="list-style-type: none"> <li>• 24...240 VAC/DC self adaptable power supply</li> <li>• Up to 5 different running times adjustable on site</li> <li>• 95° angle of rotation (5° for pretension)</li> <li>• 100% overload protected</li> <li>• Aluminium housing IP66, cable ~ 1 m</li> <li>• -40...+40°C/+50°C, integrated heater</li> <li>• Emergency manual override</li> <li>• Squared shaft connection 16 × 16 mm</li> <li>• Dimensions (H × W × D) 288 × 149 × 116 mm</li> </ul>

### Ex-d quarter turn actuators without spring return, 24 to 240 VAC/DC, for zone 1, 2, 21, 22

Type	Torque	Running time 90°	Spring return	Control mode	Feedback	Features	Size
ExMax-50.75	50 Nm / 75 Nm	40/60/90/120/150 sec.	-	On-off, 3-pos	-	-	M
ExMax- 100	100 Nm	40/60/90/120/150 sec.	-	On-off, 3-pos	-	-	M
ExMax- 150	150 Nm	40/60/90/120 sec.	-	On-off, 3-pos	-	-	M
ExMax-50.75-S	50 Nm / 75 Nm	40/60/90/120/150 sec.	-	On-off, 3-pos	2 × aux. switches (5°/85°)	-	M
ExMax- 100-S	100 Nm	40/60/90/120/150 sec.	-	On-off, 3-pos	2 × aux. switches (5°/85°)	-	M
ExMax- 150-S	150 Nm	40/60/90/120 sec.	-	On-off, 3-pos	2 × aux. switches (5°/85°)	-	M
ExMax-50.75-Y	50 Nm / 75 Nm	40/60/90/120/150 sec.	-	3-pos, 0...10 VDC, 4...20 mA	0...10 VDC, 4...20 mA	-	M
ExMax- 100-Y	100 Nm	40/60/90/120/150 sec.	-	3-pos, 0...10 VDC, 4...20 mA	0...10 VDC, 4...20 mA	-	M

### Ex-d quarter turn actuators with spring return, 24 to 240 VAC/DC, for zone 1, 2, 21, 22

Type	Torque	Running time 90°	Spring return	Control mode	Feedback	Features	Size
ExMax-30- F	30 Nm	40/60/90/120/150 sec.	~ 20 sec.	On-off, 3-pos	-	-	M
ExMax-50- F	50 Nm	40/60/90/120/150 sec.	~ 20 sec.	On-off, 3-pos	-	-	M
ExMax-60- F	60 Nm	40/60/90/120 sec.	~ 20 sec.	On-off, 3-pos	-	-	M
ExMax-30-SF	30 Nm	40/60/90/120/150 sec.	~ 20 sec.	On-off, 3-pos	2 × aux. switches (5°/85°)	-	M
ExMax-50-SF	50 Nm	40/60/90/120/150 sec.	~ 20 sec.	On-off, 3-pos	2 × aux. switches (5°/85°)	-	M
ExMax-60-SF	60 Nm	40/60/90/120 sec.	~ 20 sec.	On-off, 3-pos	2 × aux. switches (5°/85°)	-	M
ExMax-30-YF	30 Nm	40/60/90/120/150 sec.	~ 20 sec.	3-pos, 0...10 VDC, 4...20 mA	0...10 VDC, 4...20 mA	-	M
ExMax-50-YF	50 Nm	40/60/90/120/150 sec.	~ 20 sec.	3-pos, 0...10 VDC, 4...20 mA	0...10 VDC, 4...20 mA	-	M
ExMax-30-BF	30 Nm	40/60/90/120/150 sec.	~ 20 sec.	On-off, 3-pos	2 × aux. switches (5°/85°)	ExPro-TT-.. connector	M
ExMax-50-BF	50 Nm	40/60/90/120/150 sec.	~ 20 sec.	On-off, 3-pos	2 × aux. switches (5°/85°)	ExPro-TT-.. connector	M
ExMax-60-BF	60 Nm	40/60/90/120 sec.	~ 20 sec.	On-off, 3-pos	2 × aux. switches (5°/85°)	ExPro-TT-.. connector	M

### Ex-d quarter turn actuators with 3 sec. spring return for Offshore application, 24 to 240 VAC/DC, for zone 1, 2, 21, 22

Type	Torque	Running time 90°	Spring return	Control mode	Feedback	Features	Size
ExMax-30- F3	30 Nm	40/60/90/120/150 sec.	≤ 3 sec.	On-off	-	-	M
ExMax-50- F3	50 Nm	40/60/90/120/150 sec.	≤ 3 sec.	On-off	-	-	M
ExMax-30-SF3	30 Nm	40/60/90/120/150 sec.	≤ 3 sec.	On-off	2 × aux. switches (5°/85°)	-	M
ExMax-50-SF3	50 Nm	40/60/90/120/150 sec.	≤ 3 sec.	On-off	2 × aux. switches (5°/85°)	-	M
ExMax-30-BF3	30 Nm	40/60/90/120/150 sec.	≤ 3 sec.	On-off	2 × aux. switches (5°/85°)	ExPro-TT-.. connector	M
ExMax-50-BF3	50 Nm	40/60/90/120/150 sec.	≤ 3 sec.	On-off	2 × aux. switches (5°/85°)	ExPro-TT-.. connector	M

### Accessories

Type	Technical data
ExSwitch	External, adaptable, on site adjustable Ex-d auxiliary switch with 2 potential free contacts, adaptable to ExMax-... actuators
ExBox-3P	Ex-e terminal box connectable to ExMax-... actuators with 1 cable for On-off or 3-pos operation
ExBox-3P/SW	Ex-e terminal box connectable to ExMax-... actuators with 1 cable for On-off or 3-pos operation + 2 cable for external aux. switches type ExSwitch
ExBox-Y/S	Ex-e terminal box connectable to ExMax-... actuators with 2 cable, for modulating operation or 3-pos + integrated switches (HS)
ExBox-Y/S/SW	Ex-e terminal box connectable to ExMax-... actuators with 2 cable, for modulating or 3-pos operation with feedback signal + 2 cable for external aux. switches
ExBox-BF	Ex-e terminal box connectable to ExMax-... actuators with 1 cable, for all ExMax-...-BF
ExBox-BF/SW	Ex-e terminal box connectable to ExMax-... actuators with 1 cable, for all ExMax-...-BF + 2 cable for external aux. switches type ExSwitch
MKK-M	Mounting bracket for ...Box-terminal boxes for direct coupling to ...Max... actuators size M
HV-MK	Manual override, connectable to actuators size M (not suitable for ..Max-...-F3!)
AR-16-xx	Squared reduction part from 16 × 16 mm to shafts with 14 mm (type AR-16-14), 12 mm (type AR-16-12)
ExPro-TT-...	Safety temperature trigger for fire dampers, switching at 71°/72°C, with 1 m cable, suitable only for ExMax-/RedMax-...-BF actuators!
EXC-DS1/VA	Safety temperature sensor for duct mounting, potential free contact, switching at 70°C...160°C (10°C steps)
DWB-M	Angle rotation limiter for mounting on actuator size M
Retrofit-Kit-M	Mechanical adaptation for mounting on ..Max actuators size M, required to replace a previous type EXT30..-F3, EXT50..-F3 or EXT50..

Special options and offshore kits see page 23

## RedMax 90° Ex quarter turn actuators "S" for zone 2, 22

Explosion proof

Features of RedMax - ... size S

RedMax-...	Size S	Description	Basics for all RedMax-.. size S
Zone 2, 22 Gas + Dust certified according ATEX, IECEx, GOST-R, RTN, INMETRO, UL*, CSA*, *...-A version only		RedMax are, in acc. with type, for automation of air dampers, fire and smoke dampers, volume control, as well as for ball valves, throttle valves and other quarter turn armatures.  <b>Delivery:</b> 1 actuator, ~ 1 m cable, allen key for manual override, 4 screws.	<ul style="list-style-type: none"> <li>• 24...240 VAC/DC self adaptable power supply</li> <li>• Up to 5 different running times adjustable on site</li> <li>• 95° angle of rotation (5° for pretension)</li> <li>• 100% overload protected</li> <li>• Aluminium housing IP66, cable ~ 1 m</li> <li>• -40...+40°C/+50°C, integrated heater</li> <li>• Emergency manual override</li> <li>• Squared shaft connection 12 x 12 mm</li> <li>• Dimensions (H x W x D) 210 x 95 x 80 mm</li> </ul>

### Ex-n quarter turn actuators without spring return, 24 to 240 VAC/DC, for zone 2, 22

Type	Torque	Running time 90°	Spring return	Control mode	Feedback	Features	Size
RedMax- 5.10	5 Nm / 10 Nm	3/15/30/60/120 sec.	-	On-off, 3-pos	-	-	S
RedMax-15.30	15 Nm / 30 Nm	3/15/30/60/120 sec.	-	On-off, 3-pos	-	-	S
RedMax- 5.10-S	5 Nm / 10 Nm	3/15/30/60/120 sec.	-	On-off, 3-pos	2 x aux. switches (5°/85°)	-	S
RedMax-15.30-S	15 Nm / 30 Nm	3/15/30/60/120 sec.	-	On-off, 3-pos	2 x aux. switches (5°/85°)	-	S
RedMax- 5.10-Y	5 Nm / 10 Nm	7,5/15/30/60/120 sec.	-	3-pos, 0...10 VDC, 4...20 mA	0...10 VDC, 4...20 mA	-	S
RedMax-15.30-Y	15 Nm / 30 Nm	7,5/15/30/60/120 sec.	-	3-pos, 0...10 VDC, 4...20 mA	0...10 VDC, 4...20 mA	-	S

### Ex-n quarter turn actuators with spring return, 24 to 240 VAC/DC, for zone 2, 22

Type	Torque	Running time 90°	Spring return	Control mode	Feedback	Features	Size
RedMax-5.10- F	5 Nm / 10 Nm	3/15/30/60/120 sec.	~ 3 sec. / 10 sec.	On-off, 3-pos	-	-	S
RedMax- 15- F	15 Nm	3/15/30/60/120 sec.	~ 3 sec. / 10 sec.	On-off, 3-pos	-	-	S
RedMax-5.10-SF	5 Nm / 10 Nm	3/15/30/60/120 sec.	~ 3 sec. / 10 sec.	On-off, 3-pos	2 x aux. switches (5°/85°)	-	S
RedMax- 15-SF	15 Nm	3/15/30/60/120 sec.	~ 3 sec. / 10 sec.	On-off, 3-pos	2 x aux. switches (5°/85°)	-	S
RedMax-5.10-YF	5 Nm / 10 Nm	7,5/15/30/60/120 sec.	~ 3 sec. / 10 sec.	3-pos, 0...10 VDC, 4...20 mA	0...10 VDC, 4...20 mA	-	S
RedMax- 15-YF	15 Nm	7,5/15/30/60/120 sec.	~ 3 sec. / 10 sec.	3-pos, 0...10 VDC, 4...20 mA	0...10 VDC, 4...20 mA	-	S
RedMax-5.10-BF	5 Nm / 10 Nm	3/15/30/60/120 sec.	~ 3 sec. / 10 sec.	On-off, 3-pos	2 x aux. switches (5°/85°)	ExPro-TT... connector	S
RedMax- 15-BF	15 Nm	3/15/30/60/120 sec.	~ 3 sec. / 10 sec.	On-off, 3-pos	2 x aux. switches (5°/85°)	ExPro-TT... connector	S

### Ex-n quarter turn actuators with 1 sec. spring return for Offshore application, 24 to 240 VAC/DC, for zone 2, 22

Type	Torque	Running time 90°	Spring return	Control mode	Feedback	Features	Size
RedMax- 8- F1	8 Nm	3/15/30/60/120 sec.	≤ 1 sec.	On-off	-	-	S
RedMax-15- F1	15 Nm	3/15/30/60/120 sec.	≤ 1 sec.	On-off	-	-	S
RedMax- 8-SF1	8 Nm	3/15/30/60/120 sec.	≤ 1 sec.	On-off	2 x aux. switches (5°/85°)	-	S
RedMax-15-SF1	15 Nm	3/15/30/60/120 sec.	≤ 1 sec.	On-off	2 x aux. switches (5°/85°)	-	S
RedMax- 8-BF1	8 Nm	3/15/30/60/120 sec.	≤ 1 sec.	On-off	2 x aux. switches (5°/85°)	ExPro-TT... connector	S
RedMax-15-BF1	15 Nm	3/15/30/60/120 sec.	≤ 1 sec.	On-off	2 x aux. switches (5°/85°)	ExPro-TT... connector	S

### Accessories

Type	Technical data
RedSwitch	External, adaptable, on site adjustable auxiliary switch with 2 potential free contacts, adaptable to RedMax-... actuators
RedBox-3P	Ex-e terminal box connectable to RedMax-... actuators with 1 cable for On-off or 3-pos operation
RedBox-3P/SW	Ex-e terminal box connectable to RedMax-... actuators with 1 cable for On-off or 3-pos operation + 2 cable for external aux. switches type RedSwitch
RedBox-Y/S	Ex-e terminal box connectable to RedMax-... actuators with 2 cable, for modulating operation or 3-pos + integrated switches (HS)
RedBox-Y/S/SW	Ex-e terminal box connectable to RedMax-... actuators with 2 cable, for modulating or 3-pos operation with feedback signal + 2 cable for external aux. switches
RedBox-BF	Ex-e terminal box connectable to RedMax-... actuators with 1 cable, for all RedMax-...-BF
RedBox-BF/SW	Ex-e terminal box connectable to RedMax-... actuators with 1 cable, for all RedMax-...-BF + 2 cable for external aux. switches type RedSwitch
MKK-S	Mounting bracket for ...Box-terminal boxes for direct coupling to ...Max... actuators size S
KB-S	Mounting clamp for round damper shaft Ø 10 to 20 mm and squared shafts 10 to 16 mm, incl. bracket, connectable to all RedMax-... size S
KB-A	Shaft connection for damper shafts Ø ½", adaptable for all North American ..Max-... actuators size S
HV-SK, HV-SL	Manual override, connectable to actuators size S. HV-SK = short version, HV-SL = long version for add. mounting of ..Box/..Switch (not suitable for ..Max-...-F1!)
AR-12-xx	Squared reduction part from 12 x 12 mm to shafts with 11 mm (type AR-12-11), 10 mm (type AR-12-10), 8 mm (type AR-12-08)
ExPro-TT-...	Safety temperature trigger for fire dampers, switching at 71°/72°C, with 1 m cable, suitable only for ExMax-/RedMax-...-BF actuators!
EXC-DS1/VA	Safety temperature sensor for duct mounting, potential free contact, switching at 70°C...160°C (10°C steps)
DWB-S	Angle rotation limiter for mounting on actuator size S (details on request)
Retrofit-Kit-S	Mechanical adaptation for mounting on ..Max actuators size S, required to replace a previous type EXT15...-F1, EXT12...-F16, EXT15... or EXT30..

Special options and offshore kits see page 23

## RedMax 90° Ex quarter turn actuators "M" for zone 2, 22

Explosion proof

Features of RedMax - ... size M

RedMax-...	Size M	Description	Basics for all RedMax-.. size M
Zone 2, 22 Gas + Dust certified according ATEX, IECEx, GOST-R, RTN, INMETRO, UL*, CSA*, *...-A version only		RedMax are, in acc. with type, for automation of air dampers, fire and smoke dampers, volume control, as well as for ball valves, throttle valves and other quarter turn armatures.  <b>Delivery:</b> 1 actuator, ~ 1 m cable, allen key for manual override, 4 screws.	<ul style="list-style-type: none"> <li>• 24...240 VAC/DC self adaptable power supply</li> <li>• Up to 5 different running times adjustable on site</li> <li>• 95° angle of rotation (5° for pretension)</li> <li>• 100% overload protected</li> <li>• Aluminium housing IP66, cable ~ 1 m</li> <li>• -40...+40°C/+50°C, integrated heater</li> <li>• Emergency manual override</li> <li>• Squared shaft connection 16 x 16 mm</li> <li>• Dimensions (H x W x D) 288 x 149 x 116 mm</li> </ul>

### Ex-n quarter turn actuators without spring return, 24 to 240 VAC/DC, for zone 2, 22

Type	Torque	Running time 90°	Spring return	Control mode	Feedback	Features	Size
RedMax-50.75	50 Nm / 75 Nm	40/60/90/120/150 sec.	-	On-off, 3-pos	-	-	M
RedMax- 100	100 Nm	40/60/90/120/150 sec.	-	On-off, 3-pos	-	-	M
RedMax- 150	150 Nm	40/60/90/120 sec.	-	On-off, 3-pos	-	-	M
RedMax-50.75-S	50 Nm / 75 Nm	40/60/90/120/150 sec.	-	On-off, 3-pos	2 x aux. switches (5°/85°)	-	M
RedMax- 100-S	100 Nm	40/60/90/120/150 sec.	-	On-off, 3-pos	2 x aux. switches (5°/85°)	-	M
RedMax- 150-S	150 Nm	40/60/90/120 sec.	-	On-off, 3-pos	2 x aux. switches (5°/85°)	-	M
RedMax-50.75-Y	50 Nm / 75 Nm	40/60/90/120/150 sec.	-	3-pos, 0...10 VDC, 4...20 mA	0...10 VDC, 4...20 mA	-	M
RedMax- 100-Y	100 Nm	40/60/90/120/150 sec.	-	3-pos, 0...10 VDC, 4...20 mA	0...10 VDC, 4...20 mA	-	M

### Ex-n quarter turn actuators with spring return, 24 to 240 VAC/DC, for zone 2, 22

Type	Torque	Running time 90°	Spring return	Control mode	Feedback	Features	Size
RedMax-30- F	30 Nm	40/60/90/120/150 sec.	~ 20 sec.	On-off, 3-pos	-	-	M
RedMax-50- F	50 Nm	40/60/90/120/150 sec.	~ 20 sec.	On-off, 3-pos	-	-	M
RedMax-60- F	60 Nm	40/60/90/120 sec.	~ 20 sec.	On-off, 3-pos	-	-	M
RedMax-30-SF	30 Nm	40/60/90/120/150 sec.	~ 20 sec.	On-off, 3-pos	2 x aux. switches (5°/85°)	-	M
RedMax-50-SF	50 Nm	40/60/90/120/150 sec.	~ 20 sec.	On-off, 3-pos	2 x aux. switches (5°/85°)	-	M
RedMax-60-SF	60 Nm	40/60/90/120 sec.	~ 20 sec.	On-off, 3-pos	2 x aux. switches (5°/85°)	-	M
RedMax-30-YF	30 Nm	40/60/90/120/150 sec.	~ 20 sec.	3-pos, 0...10 VDC, 4...20 mA	0...10 VDC, 4...20 mA	-	M
RedMax-50-YF	50 Nm	40/60/90/120/150 sec.	~ 20 sec.	3-pos, 0...10 VDC, 4...20 mA	0...10 VDC, 4...20 mA	-	M
RedMax-30-BF	30 Nm	40/60/90/120/150 sec.	~ 20 sec.	On-off, 3-pos	2 x aux. switches (5°/85°)	ExPro-TT-.. connector	M
RedMax-50-BF	50 Nm	40/60/90/120/150 sec.	~ 20 sec.	On-off, 3-pos	2 x aux. switches (5°/85°)	ExPro-TT-.. connector	M
RedMax-60-BF	60 Nm	40/60/90/120 sec.	~ 20 sec.	On-off, 3-pos	2 x aux. switches (5°/85°)	ExPro-TT-.. connector	M

### Ex-n quarter turn actuators with 3 sec. spring return for Offshore application, 24 to 240 VAC/DC, for zone 2, 22

Type	Torque	Running time 90°	Spring return	Control mode	Feedback	Features	Size
RedMax-30- F3	30 Nm	40/60/90/120/150 sec.	≤ 3 sec.	On-off	-	-	M
RedMax-50- F3	50 Nm	40/60/90/120/150 sec.	≤ 3 sec.	On-off	-	-	M
RedMax-30-SF3	30 Nm	40/60/90/120/150 sec.	≤ 3 sec.	On-off	2 x aux. switches (5°/85°)	-	M
RedMax-50-SF3	50 Nm	40/60/90/120/150 sec.	≤ 3 sec.	On-off	2 x aux. switches (5°/85°)	-	M
RedMax-30-BF3	30 Nm	40/60/90/120/150 sec.	≤ 3 sec.	On-off	2 x aux. switches (5°/85°)	ExPro-TT-.. connector	M
RedMax-50-BF3	50 Nm	40/60/90/120/150 sec.	≤ 3 sec.	On-off	2 x aux. switches (5°/85°)	ExPro-TT-.. connector	M

### Accessories

Type	Technical data
RedSwitch	External, adaptable, on site adjustable auxiliary switch with 2 potential free contacts, adaptable to RedMax-... actuators
RedBox-3P	Ex-e terminal box connectable to RedMax-... actuators with 1 cable for On-off or 3-pos operation
RedBox-3P/SW	Ex-e terminal box connectable to RedMax-... actuators with 1 cable for On-off or 3-pos operation + 2 cable for external aux. switches type RedSwitch
RedBox-Y/S	Ex-e terminal box connectable to RedMax-... actuators with 2 cable, for modulating operation or 3-pos + integrated switches (HS)
RedBox-Y/S/SW	Ex-e terminal box connectable to RedMax-... actuators with 2 cable, for modulating or 3-pos operation with feedback signal + 2 cable for external aux. switches
RedBox-BF	Ex-e terminal box connectable to RedMax-... actuators with 1 cable, for all RedMax-...-BF
RedBox-BF/SW	Ex-e terminal box connectable to RedMax-... actuators with 1 cable, for all RedMax-...-BF + 2 cable for external aux. switches type RedSwitch
MKK-M	Mounting bracket for ...Box-terminal boxes for direct coupling to ...Max-... actuators size M
HV-MK	Manual override, connectable to actuators size M (not suitable for ..Max-...-F3!)
AR-16-xx	Squared reduction part from 16 x 16 mm to shafts with 14 mm (type AR-16-14), 12 mm (type AR-16-12)
ExPro-TT-...	Safety temperature trigger for fire dampers, switching at 71°/72°C, with 1 m cable, suitable only for ExMax-/RedMax-...-BF actuators!
EXC-DS1/VA	Safety temperature sensor for duct mounting, potential free contact, switching at 70°C...160°C (10°C steps)
DWB-M	Angle rotation limiter for mounting on actuator size M
Retrofit-Kit-M	Mechanical adaptation for mounting on ..Max actuators size M, required to replace a previous type EXT30-..F3, EXT50-..F3 or EXT50..

Special options and offshore kits see page 23

## InMax 90° quarter turn actuators "S" for safe area

Industrial

Features of InMax - ... size S

InMax-...	Size S	Description	Basics for all InMax-... size S
NOT Explosion proof and only for use in safe area IP66		InMax are, in acc. with type, for automation of air dampers, fire and smoke dampers, volume control, as well as for ball valves, throttle valves and other quarter turn armatures.  <b>Delivery:</b> 1 actuator, ~ 1 m cable, allen key for manual override, 4 screws.	<ul style="list-style-type: none"> <li>• 24...240 VAC/DC self adaptable power supply</li> <li>• Up to 5 different running times adjustable on site</li> <li>• 95° angle of rotation (5° for pretension)</li> <li>• 100% overload protected</li> <li>• Aluminium housing IP66, cable ~ 1 m</li> <li>• -40...+50°C, integrated heater</li> <li>• Emergency manual override</li> <li>• Squared shaft connection 12 x 12 mm</li> <li>• Dimensions (H x W x D) 210 x 95 x 80 mm</li> </ul>

### Quarter turn actuators without spring return, 24 to 240 VAC/DC, for safe area

Type	Torque	Running time 90°	Spring return	Control mode	Feedback	Features	Size
InMax- 5.10	5 Nm / 10 Nm	3/15/30/60/120 sec.	-	On-off, 3-pos	-	-	S
InMax-15.30	15 Nm / 30 Nm	3/15/30/60/120 sec.	-	On-off, 3-pos	-	-	S
InMax- 5.10-S	5 Nm / 10 Nm	3/15/30/60/120 sec.	-	On-off, 3-pos	2 x aux. switches (5°/85°)	-	S
InMax-15.30-S	15 Nm / 30 Nm	3/15/30/60/120 sec.	-	On-off, 3-pos	2 x aux. switches (5°/85°)	-	S
InMax- 5.10-Y	5 Nm / 10 Nm	7,5/15/30/60/120 sec.	-	3-pos, 0...10 VDC, 4...20 mA	0...10 VDC, 4...20 mA	-	S
InMax-15.30-Y	15 Nm / 30 Nm	7,5/15/30/60/120 sec.	-	3-pos, 0...10 VDC, 4...20 mA	0...10 VDC, 4...20 mA	-	S

### Quarter turn actuators with spring return, 24 to 240 VAC/DC, for safe area

Type	Torque	Running time 90°	Spring return	Control mode	Feedback	Features	Size
InMax-5.10-F	5 Nm / 10 Nm	3/15/30/60/120 sec.	~ 3 sec. / 10 sec.	On-off, 3-pos	-	-	S
InMax- 15-F	15 Nm	3/15/30/60/120 sec.	~ 3 sec. / 10 sec.	On-off, 3-pos	-	-	S
InMax-5.10-SF	5 Nm / 10 Nm	3/15/30/60/120 sec.	~ 3 sec. / 10 sec.	On-off, 3-pos	2 x aux. switches (5°/85°)	-	S
InMax- 15-SF	15 Nm	3/15/30/60/120 sec.	~ 3 sec. / 10 sec.	On-off, 3-pos	2 x aux. switches (5°/85°)	-	S
InMax-5.10-YF	5 Nm / 10 Nm	7,5/15/30/60/120 sec.	~ 3 sec. / 10 sec.	3-pos, 0...10 VDC, 4...20 mA	0...10 VDC, 4...20 mA	-	S
InMax- 15-YF	15 Nm	7,5/15/30/60/120 sec.	~ 3 sec. / 10 sec.	3-pos, 0...10 VDC, 4...20 mA	0...10 VDC, 4...20 mA	-	S
InMax-5.10-BF	5 Nm / 10 Nm	3/15/30/60/120 sec.	~ 3 sec. / 10 sec.	On-off, 3-pos	2 x aux. switches (5°/85°)	InPro-TT-... connector	S
InMax- 15-BF	15 Nm	3/15/30/60/120 sec.	~ 3 sec. / 10 sec.	On-off, 3-pos	2 x aux. switches (5°/85°)	InPro-TT-... connector	S

### Quarter turn actuators with 1 sec. spring return for Offshore application, 24 to 240 VAC/DC, for safe area

Type	Torque	Running time 90°	Spring return	Control mode	Feedback	Features	Size
InMax- 8-F1	8 Nm	3/15/30/60/120 sec.	≤ 1 sec.	On-off	-	-	S
InMax-15-F1	15 Nm	3/15/30/60/120 sec.	≤ 1 sec.	On-off	-	-	S
InMax- 8-SF1	8 Nm	3/15/30/60/120 sec.	≤ 1 sec.	On-off	2 x aux. switches (5°/85°)	-	S
InMax-15-SF1	15 Nm	3/15/30/60/120 sec.	≤ 1 sec.	On-off	2 x aux. switches (5°/85°)	-	S
InMax- 8-BF1	8 Nm	3/15/30/60/120 sec.	≤ 1 sec.	On-off	2 x aux. switches (5°/85°)	InPro-TT-... connector	S
InMax-15-BF1	15 Nm	3/15/30/60/120 sec.	≤ 1 sec.	On-off	2 x aux. switches (5°/85°)	InPro-TT-... connector	S

### Accessories

Type	Technical data
InSwitch	External, adaptable, on site adjustable auxiliary switch with 2 potential free contacts, adaptable to InMax-... actuators
InBox-3P	Terminal box connectable to InMax-... actuators with 1 cable for On-off or 3-pos operation
InBox-3P/SW	Terminal box connectable to InMax-... actuators with 1 cable for On-off or 3-pos operation + 2 cable for external aux. switches type InSwitch
InBox-Y/S	Terminal box connectable to InMax-... actuators with 2 cable, for modulating operation or 3-pos + integrated switches (HS)
InBox-Y/S/SW	Terminal box connectable to InMax-... actuators with 2 cable, for modulating or 3-pos operation with feedback signal + 2 cable for external aux. switches
InBox-BF	Terminal box connectable to InMax-... actuators with 1 cable, for all InMax-...-BF
InBox-BF/SW	Terminal box connectable to InMax-... actuators with 1 cable, for all InMax-...-BF + 2 cable for external aux. switches type InSwitch
MKK-S	Mounting bracket for ...Box-terminal boxes for direct coupling to ...Max-... actuators size S
KB-S	Mounting clamp for round damper shaft Ø 10 to 20 mm and squared shafts 10 to 16 mm, incl. bracket, connectable to all InMax-... size S
KB-A	Shaft connection for damper shafts Ø ½", adaptable for all North American ..Max-... actuators size S
HV-SK, HV-SL	Manual override, connectable to actuators size S. HV-SK = short version, HV-SL = long version for add. mounting of ..Box/ ..Switch (not suitable for ..Max-...-F1!)
AR-12-xx	Squared reduction part from 12 x 12 mm to shafts with 11 mm (type AR-12-11), 10 mm (type AR-12-10), 8 mm (type AR-12-08)
InPro-TT-...	Safety temperature trigger for fire dampers, switching at 71°/72°C, with 1 m cable, suitable only for InMax-...-BF actuators!
EXC-DS1/VA	Safety temperature sensor for duct mounting, potential free contact, switching at 70°C...160°C (10°C steps)
DWB-S	Angle rotation limiter for mounting on actuator size S (details on request)
Retrofit-Kit-S	Mechanical adaptation for mounting on ..Max actuators size S, required to replace a previous type NOT15..-F1, NOT12..-F16, NOT15.. or NOT30..

Special options and offshore kits see page 23

## InMax 90° quarter turn actuators "M" for safe area

Industrial

Features of InMax - ... size M

InMax-...	Size M	Description	Basics for all InMax-.. size M
NOT Explosion proof and only for use in safe area IP66		InMax are, in acc. with type, for automation of air dampers, fire and smoke dampers, volume control, as well as for ball valves, throttle valves and other quarter turn armatures.  <b>Delivery:</b> 1 actuator, ~ 1 m cable, allen key for manual override, 4 screws.	<ul style="list-style-type: none"> <li>• <b>24...240 VAC/DC</b> self adaptable power supply</li> <li>• Up to 5 different running times adjustable on site</li> <li>• 95° angle of rotation (5° for pretension)</li> <li>• 100% overload protected</li> <li>• Aluminium housing IP66, cable ~ 1 m</li> <li>• -40...+50°C, integrated heater</li> <li>• Emergency manual override</li> <li>• Squared shaft connection 16 x 16 mm</li> <li>• Dimensions (H x W x D) 288 x 149 x 116 mm</li> </ul>

### Quarter turn actuators without spring return, 24 to 240 VAC/DC, for safe area

Type	Torque	Running time 90°	Spring return	Control mode	Feedback	Features	Size
InMax-50.75	50 Nm / 75 Nm	40/60/90/120/150 sec.	-	On-off, 3-pos	-	-	M
InMax- 100	100 Nm	40/60/90/120/150 sec.	-	On-off, 3-pos	-	-	M
InMax- 150	150 Nm	40/60/90/120 sec.	-	On-off, 3-pos	-	-	M
InMax-50.75-S	50 Nm / 75 Nm	40/60/90/120/150 sec.	-	On-off, 3-pos	2 x aux. switches (5°/85°)	-	M
InMax- 100-S	100 Nm	40/60/90/120/150 sec.	-	On-off, 3-pos	2 x aux. switches (5°/85°)	-	M
InMax- 150-S	150 Nm	40/60/90/120 sec.	-	On-off, 3-pos	2 x aux. switches (5°/85°)	-	M
InMax-50.75-Y	50 Nm / 75 Nm	40/60/90/120/150 sec.	-	3-pos, 0...10 VDC, 4...20 mA	0...10 VDC, 4...20 mA	-	M
InMax- 100-Y	100 Nm	40/60/90/120/150 sec.	-	3-pos, 0...10 VDC, 4...20 mA	0...10 VDC, 4...20 mA	-	M

### Quarter turn actuators with spring return, 24 to 240 VAC/DC, for safe area

Type	Torque	Running time 90°	Spring return	Control mode	Feedback	Features	Size
InMax-30- F	30 Nm	40/60/90/120/150 sec.	~ 20 sec.	On-off, 3-pos	-	-	M
InMax-50- F	50 Nm	40/60/90/120/150 sec.	~ 20 sec.	On-off, 3-pos	-	-	M
InMax-60- F	60 Nm	40/60/90/120 sec.	~ 20 sec.	On-off, 3-pos	-	-	M
InMax-30-SF	30 Nm	40/60/90/120/150 sec.	~ 20 sec.	On-off, 3-pos	2 x aux. switches (5°/85°)	-	M
InMax-50-SF	50 Nm	40/60/90/120/150 sec.	~ 20 sec.	On-off, 3-pos	2 x aux. switches (5°/85°)	-	M
InMax-60-SF	60 Nm	40/60/90/120 sec.	~ 20 sec.	On-off, 3-pos	2 x aux. switches (5°/85°)	-	M
InMax-30-YF	30 Nm	40/60/90/120/150 sec.	~ 20 sec.	3-pos, 0...10 VDC, 4...20 mA	0...10 VDC, 4...20 mA	-	M
InMax-50-YF	50 Nm	40/60/90/120/150 sec.	~ 20 sec.	3-pos, 0...10 VDC, 4...20 mA	0...10 VDC, 4...20 mA	-	M
InMax-30-BF	30 Nm	40/60/90/120/150 sec.	~ 20 sec.	On-off, 3-pos	2 x aux. switches (5°/85°)	InPro-TT-.. connector	M
InMax-50-BF	50 Nm	40/60/90/120/150 sec.	~ 20 sec.	On-off, 3-pos	2 x aux. switches (5°/85°)	InPro-TT-.. connector	M
InMax-60-BF	60 Nm	40/60/90/120 sec.	~ 20 sec.	On-off, 3-pos	2 x aux. switches (5°/85°)	InPro-TT-.. connector	M

### Quarter turn actuators with 3 sec. spring return for Offshore application, 24 to 240 VAC/DC, for safe area

Type	Torque	Running time 90°	Spring return	Control mode	Feedback	Features	Size
InMax-30- F3	30 Nm	40/60/90/120/150 sec.	≤ 3 sec.	On-off	-	-	M
InMax-50- F3	50 Nm	40/60/90/120/150 sec.	≤ 3 sec.	On-off	-	-	M
InMax-30-SF3	30 Nm	40/60/90/120/150 sec.	≤ 3 sec.	On-off	2 x aux. switches (5°/85°)	-	M
InMax-50-SF3	50 Nm	40/60/90/120/150 sec.	≤ 3 sec.	On-off	2 x aux. switches (5°/85°)	-	M
InMax-30-BF3	30 Nm	40/60/90/120/150 sec.	≤ 3 sec.	On-off	2 x aux. switches (5°/85°)	InPro-TT-.. connector	M
InMax-50-BF3	50 Nm	40/60/90/120/150 sec.	≤ 3 sec.	On-off	2 x aux. switches (5°/85°)	InPro-TT-.. connector	M

### Accessories

Type	Technical data
InSwitch	External, adaptable, on site adjustable auxiliary switch with 2 potential free contacts, adaptable to InMax-... actuators
InBox-3P	Terminal box connectable to InMax-... actuators with 1 cable for On-off or 3-pos operation
InBox-3P/SW	Terminal box connectable to InMax-... actuators with 1 cable for On-off or 3-pos operation + 2 cable for external aux. switches type InSwitch
InBox-Y/S	Terminal box connectable to InMax-... actuators with 2 cable, for modulating operation or 3-pos + integrated switches (HS)
InBox-Y/S/SW	Terminal box connectable to InMax-... actuators with 2 cable, for modulating or 3-pos operation with feedback signal + 2 cable for external aux. switches
InBox-BF	Terminal box connectable to InMax-... actuators with 1 cable, for all InMax-...-BF
InBox-BF/SW	Terminal box connectable to InMax-... actuators with 1 cable, for all InMax-...-BF + 2 cable for external aux. switches type InSwitch
MKK-M	Mounting bracket for ...Box-terminal boxes for direct coupling to ...Max-... actuators size M
HV-MK	Manual override, connectable to actuators size M (not suitable for ..Max-...-F3!)
AR-16-xx	Squared reduction part from 16 x 16 mm to shafts with 14 mm (type AR-16-14), 12 mm (type AR-16-12)
InPro-TT-...	Safety temperature trigger for fire dampers, switching at 71°/72°C, with 1 m cable, suitable only for InMax-...-BF actuators!
EXC-DS1/VA	Safety temperature sensor for duct mounting, potential free contact, switching at 70°C...160°C (10°C steps)
DWB-M	Angle rotation limiter for mounting on actuator size M
Retrofit-Kit-M	Mechanical adaptation for mounting on ..Max actuators size M, required to replace a previous type NOT30..-F3, NOT50..-F3 or NOT50..

Special options and offshore kits see page 23

## Introducing ExMax+LIN & ExRun – Valve actuators for hazardous locations!

Linear applications for valve control ...

HAZARDOUS LOCATIONS ZONE 1, 2, 21, 22

FAST SPRING RETURN TIME

UNIVERSAL POWER SUPPLY

C5-M OFFSHORE SOLUTION

EASY INSTALLATION

ROBUST IP66 HOUSING

COMPACT DIMENSIONS





## ..Max + LIN, ..Run Electrical drive engineering for valves – Overview

### Overview ..Max + LIN linear guide unit and ..Run valve actuators

The actuator series are subdivided in 3 installation- and 2 application areas.

**Installation areas:**

**ExMax-.. + LIN, ExRun-..** ..... actuators for use in hazardous areas zone 1, 2, 21, 22

**RedMax-.. + LIN, RedRun-..** ..... actuators for use in hazardous areas zone 2, 22

**InMax-.. + LIN, InRun-..** ..... actuators for use in safe area

**Application areas:**

**Ex/Red/InMax + LIN** ..... for globe- or 3-way valves (with safety function)

**Ex/Red/InRun** ..... for globe- or 3-way valves

**The actuator concept offers obvious advantages:**

1. Small dimension, compact, easy installation, highest protection classes, cost effective
2. Universal power supply 24 to 240 Volt AC/DC, selfadjustable
3. With or without spring return (spring return only at ..Max + LIN linear guide unit)
4. Robust aluminium housing, IP66
5. Integrated heater for low temperatures
6. On site adjustable motor running time
7. Integrated manual override
8. Offshore version (C5-M painted) available
9. Useful accessories such as retrofit limit switches

#### Actuators with spring return for 2-way and 3-way valves

**N ExMax+LIN**

↑ 7,5 mm-  
↓ 42 mm

normal wiring



**ExMax-., RedMax-., InMax-.. + LIN linear guide unit**

Linear motion valve actuators with spring return from 500 to 3.000 N. Fixed stroke with 7.5, 10, 15, 20, 30, or 42 mm, for automation of globe- or 3-way valves. Linkage to numerous valve types and brands available.

#### Actuators for 2-way and 3-way valves

**N ExRun**

↑ 5 mm-  
↓ 60 mm



normal wiring



**ExRun-., RedRun-., InRun-.. valve actuators**

Valve actuators from 500 to 10.000 N. On site adjustable stroke from 5 to 60 mm, for automation of globe- or 3-way valves. Linkage to numerous valve types and brands available.

## ..Max-.. + LIN-.. Linear valve actuators size “S” and “M” with spring return

Explosion proof		Industrial	Features ..Max-.. + LIN-.. (size S and M)	
<b>ExMax-.. + LIN-..</b> Zone 1, 2, 21, 22 Gas + Dust certified according ATEX, IECEx, GOST-R, RTN, INMETRO, KOSHA <sup>1</sup> <sup>1</sup> ExMax size S only UL*, CSA* *...-A version only	<b>RedMax-.. + LIN-..</b> Zone 2, 22 Gas + Dust certified according ATEX, IECEx, GOST-R, RTN, INMETRO, UL*, CSA* *...-A version only	<b>InMax-.. + LIN-..</b> NOT Explosion proof and only for use in safe area IP66	<b>Description</b> ..Max-.. + LIN-.. linear valve actuators with <b>spring return</b> for automation of globe- or 3-way valves. Use as actuator with safety function, On-off or 3-pos. actuator or modulating actuator. <b>Delivery:</b> Linear unit, suitable for all ..Max-..-F actuators size S or M. <b>Required accessories:</b> Valve adaptation in accordance with valve manufacturer, type and nominal size (diameter), terminal box, terminal box, mounting bracket. <b>Ordering example:</b> Modulating valve actuator with spring return in Ex area zone 2, for a globe valve with 20 mm stroke and a required force of 1.500 N.  Actuator: RedMax-30-YF Linear adaptation: LIN-20 Valve adaptation: suitable for valve type on requ. Required: Ex terminal box (RedBox-Y/S) Required: Mounting bracket (MKK-M)	<b>Basics for ..Max-.. + LIN-.. valve actuators</b> <ul style="list-style-type: none"> <li>• 24...240 VAC/DC self adaptable power supply</li> <li>• Running time 0,1...15 sec./mm<sup>1</sup></li> <li>• Stroke 7,5, 10, 15, 20, 30, 42 mm<sup>1</sup></li> <li>• Force 500...3.000 N<sup>1</sup></li> <li>• Spring return 3/10 sec. (size S) 20 sec. (size M)<sup>1</sup></li> <li>• Control mode On-off, 3-pos., 0-10 VDC, 4-20 mA<sup>1</sup></li> <li>• Aluminium housing, IP66<sup>2</sup></li> <li>• Ambient temperature -20...+40 °C (T6), -20...+50 °C (T5)</li> <li>• Weight (incl. actuator) ~ 8 kg (size S), ~ 14 kg (size M)<sup>1</sup></li> <li>• External terminal box optional<sup>2</sup></li> </ul> <sup>1</sup> in acc. with type   <sup>2</sup> applies for actuator
				

## Linear unit for actuators with spring return, 24 to 240 VAC/DC

Type	Stroke (max.)	Description
LIN-7.5	7,5 mm	Linear unit up to max. 7,5 mm stroke, suitable for all ..Max-..-F actuators size S or M with spring return
LIN-10	10 mm	Linear unit up to max. 10 mm stroke, suitable for all ..Max-..-F actuators size S or M with spring return
LIN-15	15 mm	Linear unit up to max. 15 mm stroke, suitable for all ..Max-..-F actuators size S or M with spring return
LIN-20	20 mm	Linear unit up to max. 20 mm stroke, suitable for all ..Max-..-F actuators size S or M with spring return
LIN-30	30 mm	Linear unit up to max. 30 mm stroke, suitable for all ..Max-..-F actuators size S or M with spring return
LIN-40	42 mm	Linear unit up to max. 42 mm stroke, suitable for all ..Max-..-F actuators size M with spring return

Additional price for adaptation, dependent on valve manufacturer, valve type and stroke.

## LIN Special options for linear unit suitable for actuators

Explosion proof/Safe area	Features LIN-...-CT		
<b>LIN-...-CT</b> available for linear unit LIN-.. In accordance with ..Max type for use in Ex area or safe area	<b>Special options</b> 	<b>Description</b> CT version with aluminium housing and C5-M painting, resistant against corrosive and maritime atmosphere, some parts nickel plated.  <b>Delivery:</b> 1 linear unit with special option <b>Ordering example:</b> LIN-20-CT	<b>Basics LIN-...-CT</b>  <b>CT:</b> <ul style="list-style-type: none"> <li>• C5-M painted aluminium housing</li> <li>• Resistant against corrosive and/or maritime atmosphere</li> </ul>

## LIN-.. options

Type	Description/Technical data
LIN-...-CT	C5-M painted aluminium housing, resistant against corrosive and/or maritime atmosphere. Lifting rod, connecting parts and screws in VA (surcharge)

Additional price for adaptation in stainless steel (VA) for CT version.

### Mounting variations

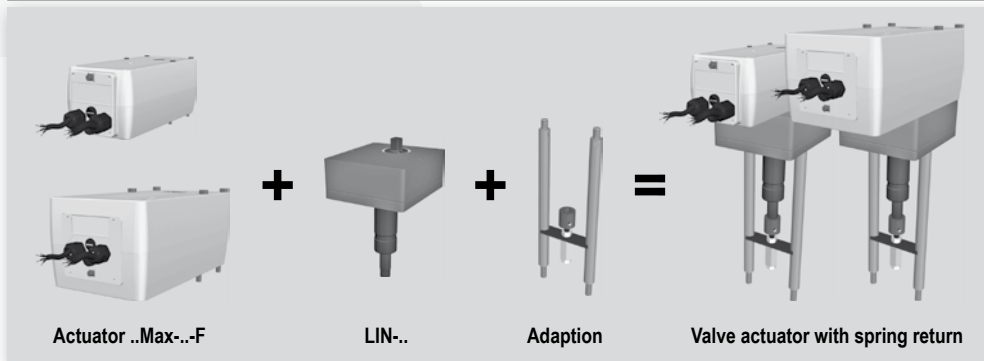

### Valve adaptation

To select the right valve adaptation and get the right price information the following data are required:

1. Valve manufacturer
2. Valve type
3. Valve nominal size (diameter) DN

For adaptations which are already designed by Schischek this information is sufficient.

To design new adaptations we need additional details of the valve body as well as drawings.

With the purchase order you have to provide actuator and valve type.

### Selection of recommended actuators in relation of force and max. stroke

Type max. stroke	LIN - 7.5	LIN - 10	LIN - 15	LIN - 20	LIN - 30	LIN - 40	
Force	7.5 mm	10 mm	15 mm	20 mm	30 mm	42 mm	
500 N	...Max- 15 - ...F	...Max- 15 - ...F	...Max- 15 - ...F	...Max- 15 - ...F	...Max- 15 - ...F	...Max- 30 - ...F	At strokes between two values use the next higher linear unit e.g. 24 mm stroke = LIN-30
800 N				...Max- 30 - ...F	...Max- 30 - ...F		
1.000 N			...Max- 30 - ...F	...Max- 50 - ...F	...		
1.500 N			...	...	...		
2.000 N	...Max- 30 - ...F	...Max- 30 - ...F	...Max- 50 - ...F	...Max- 50 - ...F	...	...	
2.500 N	...	...	...	...	...	...	
3.000 N	...	...	...	...	...	...	

**Attention:** Limitation of resolution at YF-actuators with strokes < nominal (motor blockade)!  
Note the maximum force of the actuator to prevent damage to your valve!

**Info:** Suitable actuators with spring return see page 10-15.

1

### Nominal force (N) at spring of actuator in relation of max. stroke of LIN at temperatures between -20...+40 °C

Nominal force (N)	LIN - 7.5	LIN - 10	LIN - 15	LIN - 20	LIN - 30	LIN - 40	
...Max- 15 -F	1,500	1,500	1,000	800	500	-	Blocking force in motor is round about 3 to 4 times larger than nominal force. <b>Note valve dimensioning!</b>
...Max- 30 -F	3,000	3,000	2,000	1,500	1,000	800	
...Max- 50 -F	-	-	3,000	3,000	2,000	1,500	

**Attention:** Limitation of resolution at YF-actuators with strokes < nominal (motor blockade)!  
Note the maximum force of the actuator to prevent damage to your valve!

2

### Blocking force (N) at spring of actuator in relation of max. stroke of LIN at temperatures between 0...+40 °C

Nominal force (N)	LIN - 7.5	LIN - 10	LIN - 15	LIN - 20	LIN - 30	LIN - 40	
...Max- 15 -F	3,000	3,000	2,000	1,600	1,000	-	Blocking force in motor is round about 1.5 to 2 times larger than nominal force. <b>Note valve dimensioning!</b>
...Max- 30 -F	6,000	6,000	4,000	3,000	2,000	1,600	
...Max- 50 -F	-	-	6,000	6,000	4,000	3,000	

**Attention:** Above mentioned values are nominal trusts with performed self adjustment drive!



The maximum trusts can read values which are up to three to four times higher than values of tables!

Without performed self adjustment drive there can occur much higher trust values, which can cause damages on the mentioned valve or linkages!

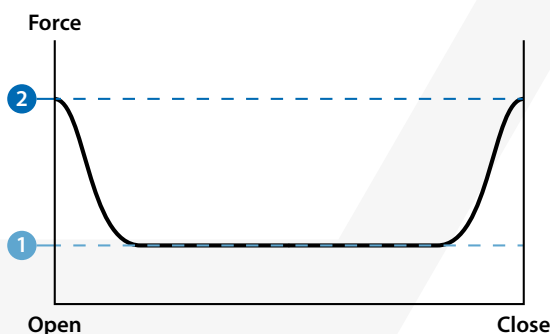
Spring return time depends on the effective required thrust and can exceed standard values!



## ExRun/RedRun/InRun Valve actuators

Explosion proof		Industrial	Features of ExRun, RedRun, InRun	
<b>ExRun...</b> Zone 1, 2, 21, 22 Gas + Dust certified according ATEX, IECEx, GOST-R, RTN, INMETRO, KOSHA, UL*, CSA* <small>*...-A version only</small>	<b>RedRun...</b> Zone 2, 22 Gas + Dust certified according ATEX, IECEx, GOST-R, RTN, INMETRO, KOSHA, UL*, CSA* <small>*...-A version only</small>	<b>InRun...</b> NOT Explosion proof and only for use in safe area IP66	<b>Description</b> ExRun, RedRun and InRun valve actuators are used for automation of 2- and 3-way valves with 3-pos. on-off or modulating mode.  <b>Delivery:</b> 1 actuator with integrated Ex-e terminal box, Emergency manual override.  <b>Required accessories:</b> Valve adaptation in accordance with valve manufacturer, type and nominal size (diameter).	<b>Basics for all ...Run valve actuators</b> <ul style="list-style-type: none"> <li>• 24...240 VAC/DC self adaptable power supply</li> <li>• Up to 5 different running times adjustable on site</li> <li>• 5 to 60 mm stroke, mechanical limitation on each position</li> <li>• Automatic adaptation of modulating signal at Ex-, Red-, InRun-...-Y..</li> <li>• Aluminium housing IP66, integrated terminal box</li> <li>• -20...+40°C/+50°C, integrated heater</li> <li>• Emergency manual override</li> <li>• Dimension (H<sup>1</sup>×W×D) 260<sup>1</sup> × 208 × 115 mm (without valve and adaptation)</li> <li>• Approximate weight 7,3...7,7 kg<sup>2</sup> (without valve and adaptation)</li> </ul> <small><sup>1</sup>Height varies depending on type <sup>2</sup>Weight varies depending on type</small>
				

### Ex-d valve actuators without spring return for zone 1, 2, 21, 22

Type	Force	Running time	Spring return	Control mode	Feedback	Features	Size
ExRun- 5.10	500 / 1.000 N	2/3/6/9/12 sec/mm	-	On-off, 3-pos	-	-	S
ExRun-25.50	2.500 / 5.000 N	2/3/6/9/12 sec/mm	-	On-off, 3-pos	-	-	S
ExRun-75.100	7.500 / 10.000 N	4/6/9/12/15 sec/mm	-	On-off, 3-pos	-	-	S
ExRun- 5.10 -Y	500 / 1.000 N	2/3/6/9/12 sec/mm	-	0...10 VDC, 4...20 mA	0...10 VDC, 4...20 mA	-	S
ExRun-25.50 -Y	2.500 / 5.000 N	2/3/6/9/12 sec/mm	-	0...10 VDC, 4...20 mA	0...10 VDC, 4...20 mA	-	S
ExRun-75.100-Y	7.500 / 10.000 N	4/6/9/12/15 sec/mm	-	0...10 VDC, 4...20 mA	0...10 VDC, 4...20 mA	-	S
ExRun- 5.10 -U	500 / 1.000 N	2/3/6/9/12 sec/mm	-	On-off, 3-pos	0...10 VDC, 4...20 mA	-	S
ExRun-25.50 -U	2.500 / 5.000 N	2/3/6/9/12 sec/mm	-	On-off, 3-pos	0...10 VDC, 4...20 mA	-	S
ExRun-75.100-U	7.500 / 10.000 N	4/6/9/12/15 sec/mm	-	On-off, 3-pos	0...10 VDC, 4...20 mA	-	S

### Ex-n valve actuators without spring return for zone 2, 22

Type	Force	Running time	Spring return	Control mode	Feedback	Features	Size
RedRun- 5.10	500 / 1.000 N	2/3/6/9/12 sec/mm	-	On-off, 3-pos	-	-	S
RedRun-25.50	2.500 / 5.000 N	2/3/6/9/12 sec/mm	-	On-off, 3-pos	-	-	S
RedRun-75.100	7.500 / 10.000 N	4/6/9/12/15 sec/mm	-	On-off, 3-pos	-	-	S
RedRun- 5.10 -Y	500 / 1.000 N	2/3/6/9/12 sec/mm	-	0...10 VDC, 4...20 mA	0...10 VDC, 4...20 mA	-	S
RedRun-25.50 -Y	2.500 / 5.000 N	2/3/6/9/12 sec/mm	-	0...10 VDC, 4...20 mA	0...10 VDC, 4...20 mA	-	S
RedRun-75.100-Y	7.500 / 10.000 N	4/6/9/12/15 sec/mm	-	0...10 VDC, 4...20 mA	0...10 VDC, 4...20 mA	-	S
RedRun- 5.10 -U	500 / 1.000 N	2/3/6/9/12 sec/mm	-	On-off, 3-pos	0...10 VDC, 4...20 mA	-	S
RedRun-25.50 -U	2.500 / 5.000 N	2/3/6/9/12 sec/mm	-	On-off, 3-pos	0...10 VDC, 4...20 mA	-	S
RedRun-75.100-U	7.500 / 10.000 N	4/6/9/12/15 sec/mm	-	On-off, 3-pos	0...10 VDC, 4...20 mA	-	S

### Valve actuators without spring return for safe area

Type	Force	Running time	Spring return	Control mode	Feedback	Features	Size
InRun- 5.10	500 / 1.000 N	2/3/6/9/12 sec/mm	-	On-off, 3-pos	-	-	S
InRun-25.50	2.500 / 5.000 N	2/3/6/9/12 sec/mm	-	On-off, 3-pos	-	-	S
InRun-75.100	7.500 / 10.000 N	4/6/9/12/15 sec/mm	-	On-off, 3-pos	-	-	S
InRun- 5.10 -Y	500 / 1.000 N	2/3/6/9/12 sec/mm	-	0...10 VDC, 4...20 mA	0...10 VDC, 4...20 mA	-	S
InRun-25.50 -Y	2.500 / 5.000 N	2/3/6/9/12 sec/mm	-	0...10 VDC, 4...20 mA	0...10 VDC, 4...20 mA	-	S
InRun-75.100-Y	7.500 / 10.000 N	4/6/9/12/15 sec/mm	-	0...10 VDC, 4...20 mA	0...10 VDC, 4...20 mA	-	S
InRun- 5.10 -U	500 / 1.000 N	2/3/6/9/12 sec/mm	-	On-off, 3-pos	0...10 VDC, 4...20 mA	-	S
InRun-25.50 -U	2.500 / 5.000 N	2/3/6/9/12 sec/mm	-	On-off, 3-pos	0...10 VDC, 4...20 mA	-	S
InRun-75.100-U	7.500 / 10.000 N	4/6/9/12/15 sec/mm	-	On-off, 3-pos	0...10 VDC, 4...20 mA	-	S

### Accessories

Type	Technical data
<b>ExSwitch-R-L</b>	External, adaptable, on site adjustable Ex-d auxiliary switch linear for Ex/RedRun.. with 2 potential free contacts, additionally Ex-e terminal box + mounting bracket necessary
<b>InSwitch- R-L</b>	External, adaptable, on site adjustable auxiliary switch linear for InRun-.. with 2 potential free contacts, additionally terminal box + mounting bracket necessary
<b>ExBox- SW</b>	Ex-e terminal box suitable for ExRun.. valve-actuators with external switches ExSwitch-R-L
<b>RedBox-SW</b>	Ex-e terminal box suitable for RedRun.. valve-actuators with external switches ExSwitch-R-L
<b>InBox- SW</b>	Terminal box suitable for InRun.. valve-actuators with external switches InSwitch-R-L
<b>MKK-S</b>	Mounting-bracket suitable for ..Box-terminal boxes for direct mounting on ..Run actuators size S
<b>HV-R</b>	Manual override suitable for ..Run valve actuators size S
<b>GMB-1</b>	Rubber bellow up to 60 mm, colour black
<b>Adaption</b>	Different adaptations for different valve types and sizes available. Please don't hesitate to ask for technical solution

Special options and offshore kits see page 23

### Required data for valve adaptation

To select the right valve adaptation and get the right price information the following data are required:

1. **Valve manufacturer**
2. **Valve type**
3. **Valve nominal size (diameter) DN**

For adaptations which are already designed by Schischek this information is sufficient.

To design new adaptations we need additional details of the valve body as well as drawings.

With the purchase order you have to provide actuator and valve type.

### ...Run + valve adaptation

ExRun-...

RedRun-...

InRun-...



Adaption



## VA/CT Special options actuators – overview

### Overview of special options of Schischek actuators for use under extreme weather conditions

#### Installation/Application area:

Usage in hazardous areas under extreme weather conditions and /or for offshore/ onshore applications.

#### Advantages of special options:

- Resistant against corrosive and/or maritime atmosphere
- Usage under extreme weather conditions
- Approved for offshore-/onshore applications
- Robust and thereby extended period of application time of actuators

<b>VAS</b> <b>CTS</b>	<b>..Max.. S</b>	<b>Special options quarter turn actuators size S</b>		<b>..Max.. ¼ turn actuators size S</b> Housing material in stainless steel (VAS) or aluminium housing with C5-M painting (CTS) for use under extreme weather conditions.
		normal wiring		
<b>VAMH</b> <b>CTM</b>	<b>..Max.. M</b>	<b>Special options quarter turn actuators size M</b>		<b>..Max.. ¼ turn actuators size M</b> Surrounding housing in stainless steel (VAMH) or aluminium housing with C5-M painting (CTM) for use under extreme weather conditions.
		normal wiring		
<b>CTS</b>	<b>..Run..</b>	<b>Special options valve actuators</b>		<b>..Run.. valve actuators</b> Aluminium housing with C5-M painting (CTS) for use under extreme weather conditions.
		normal wiring		
<b>WS-S</b> <b>WS-M</b> <b>WS-R</b>	<b>..Max.. S/M</b> <b>..Run..</b>	<b>Weather shield for quarter turn and valve actuators</b>		<b>..Max.. ¼ turn and ..Run valve actuators</b> Weather shield made of stainless steel for protection against weather influences like rain, sun or snow.
		normal wiring		

**Safe area**                      **Ex area**

- Further special features on request**
- Connection technology and cable fittings
  - Special model for temperature range, runtime, corrosion protection, certification, ...
  - Special accessories, for e.g. indicators
  - Special features, e.g. > 90° angle of rotation or rotary variants

## ..Max Special options for quarter turn actuators size S or M

### Explosion proof

### Features ..Max-...VA/CT

#### ..Max-...VA/CT

available for ExMax, RedMax and InMax  
In accordance with type for use in Ex area or safe area

#### Special options



#### Description

VA version with housing material in stainless steel similar AISI 316, some parts nickel plated.  
CT version with aluminium housing and C5-M painting, resistant against corrosive and maritime atmosphere, some parts nickel plated.

**Delivery:** 1 quarter turn actuator size S or M with special option

**Ordering example:** ExMax-15.30-VAS

#### Basics ..Max-...VA/CT

##### VA:

- Housing material in stainless steel similar AISI 316, some parts nickel plated

##### CT:

- C5-M painted aluminium housing, resistant against corrosive and/or maritime atmosphere
- Cable glands brass nickel plated
- Screws in stainless steel

For general basics see ..Max quarter turn actuators.

## ..Max-.. options

Type	Description/Technical data
..Max-... VAS	Housing material of ..Max quarter turn actuator size S in stainless steel similar AISI 316, some parts nickel plated (surcharge)
..Max-... VAMH	Enclosure for ..Max quarter turn actuator size M, made of stainless steel AISI 316 L
..Max-... CTS	Aluminium housing of ..Max quarter turn actuator size S with C5-M painting, resistant against corrosive and maritime atmosphere, some parts nickel plated (surcharge)
..Max-... CTM	Aluminium housing of ..Max quarter turn actuator size M with C5-M painting, resistant against corrosive and maritime atmosphere, some parts nickel plated (surcharge)
..Box-.../ VA	Ex-e terminal-box, housing made of stainless-steel type AISI 316 L, some parts nickel plated (surcharge)
..Box-.../ CT	Ex-e terminal-box, housing C5-M painted, resistant against corrosive/maritime atmosphere, some parts nickel plated (surcharge)
..Switch- CT	Auxiliary switch for ..Max..., housing C5-M painted, resistant against corrosive/maritime atmosphere, some parts nickel plated (surcharge)
MKK- S/VA	Mounting bracket, made of stainless-steel suitable for ..Box...VA for direct coupling to ..Max actuators size S
MKK- M/VA	Mounting bracket, made of stainless-steel suitable for ..Box...VA for direct coupling to ..Max actuators size M
MKK-VAMH/VA	Mounting bracket, made of stainless-steel suitable for ..Box...VA for coupling to ..Max actuators size M in combination with enclosure VAMH
Kit-S8-Max	Cable glands 2 x M16 x 1,5 mm Ex-e standard Ø 5-10 mm in brass nickel plated, 1 blind plug for replace the plastic version of quarter turn actuator ..Max
Kit-S8-Box	Cable glands 4 x M20 x 1,5 mm Ex-e Ø 6-13 mm, brass nickel plated, for replace the plastic version of terminal ..Box
Kit-Offs-PMC-1C	Protection metal conduit incl. SS terminal box and glands for 1 armoured cable
Kit-Offs-PMC-2C	Protection metal conduit incl. SS terminal box and glands for 2 armoured cables
WS-S	Weather shield in stainless steel, suitable for all ..Max actuators size S
WS-M	Weather shield in stainless steel, suitable for all ..Max actuators size M

## ..Run Special options for valve actuators

### Explosion proof

### Features ..Run-...CTS

#### ..Run-...CTS

available for ExRun, RedRun and InRun  
In accordance with type for use in Ex area or safe area

#### Special options



#### Description

CTS version with aluminium housing and C5-M painting, resistant against corrosive and maritime atmosphere, some parts nickel plated.

**Delivery:** 1 valve actuator with special option

**Ordering example:** ExRun-25.50-CTS

#### Basics ..Run-...CTS

##### CTS:

- C5-M painted aluminium housing, resistant against corrosive and/or maritime atmosphere
- Cable glands brass nickel plated
- Screws in stainless steel

For general basics see ..Run valve actuators.

## ..Run-.. options

Type	Description/Technical data
..Run-...-CTS	Aluminium housing with C5-M painting for ..Run valve actuator, resistant against corrosive/maritime atmosphere, some parts nickel plated (surcharge)
Kit-S8- Run	Cable glands 2 x M20 x 1,5 mm Ex-e Ø 6-13 mm, brass nickel plated, for replace the plastic version of valve actuators ..Run
Kit-Offs-GL-Run	Cable glands 2 x M25 x 1,5 mm Ex-d in brass nickel plated for armoured cables suitable for ..Run valve actuators
WS-R	Weather shield in stainless steel, suitable for all ..Run valve actuators

## ExPolar/InPolar Heating system – overview

Overview of new heating system for use with Schischek actuators down to  $-50^{\circ}\text{C}$

**Installation/Application area:**

Usage in hazardous areas for temperatures down to  $-50^{\circ}\text{C}$ .

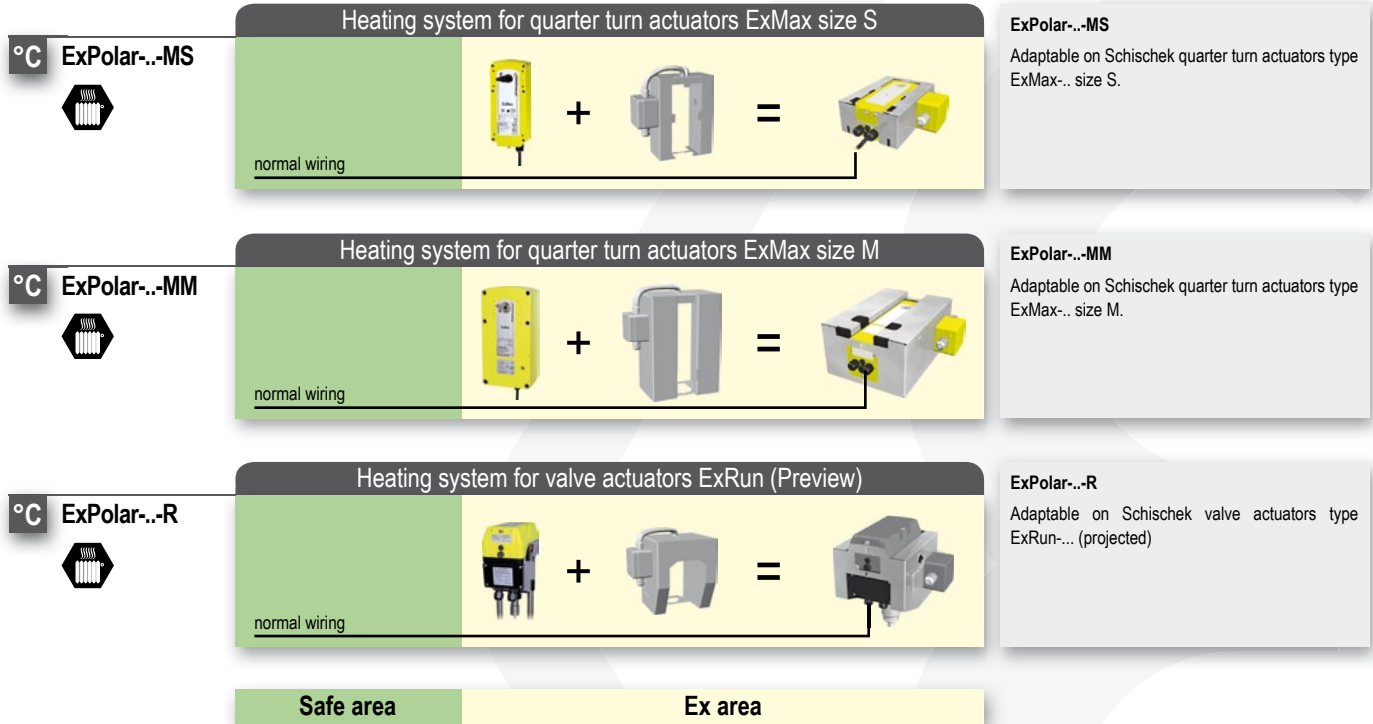

**Advantages of ExPolar/InPolar:**

- Especially for usage under high sub-zero temperatures down to  $-50^{\circ}\text{C}$
- Usage directly in hazardous locations (only ExPolar)
- Adaptable on Schischek actuator series type ..Max size S or M, (.Run and ..Max+LIN projected)





### ExPolar/InPolar Heating system for ¼ turn actuators ..Max.. size S

Explosion proof	Industrial	Features ..Polar...-MS	
<b>ExPolar...-MS</b> Zone 1, 2, 21, 22 Gas + Dust certified according ATEX, IECEx 	<b>InPolar...-MS</b> NOT explosion proof and only for use in safe area IP66 	<b>Description</b> Controlled heating system for use in sub-zero regions down to -50 °C. Adaptable on Schischek quarter turn actuators ..Max.. size S (depending on type). <b>Delivery:</b> 1 heating system (adaptable) <b>Ordering example:</b> ExPolar-240-MS	<b>Basics ..Polar</b> <ul style="list-style-type: none"> <li>• 24/48 VAC/DC, 120/240 VAC</li> <li>• 40 W</li> <li>• -50 °C... +50 °C</li> <li>• ExPolar for zone 1, 2, 21, 22</li> <li>• InPolar for safe area</li> </ul>

### ExPolar...-MS/InPolar...-MS



Type	Adaptable on	Operation temperature	Supply	Power*	Installation area
ExPolar...-MS	ExMax.../RedMax size S	-50 °C up to +50 °C	24 VAC/DC 48 VAC/DC 120 VAC 240 VAC	40 W	zone 1, 2, 21, 22
InPolar...-MS	InMax... size S	-50 °C up to +50 °C	24 VAC/DC 48 VAC/DC 120 VAC 240 VAC	40 W	safe area

↑ Supply voltage

VAS option not considered!

\*Nominal value

### ExPolar/InPolar Heating system for ¼ turn actuators ..Max.. size M

Explosion proof	Industrial	Features ..Polar...-MM	
<b>ExPolar...-MM</b> Zone 1, 2, 21, 22 Gas + Dust certified according ATEX, IECEx 	<b>InPolar...-MM</b> NOT explosion proof and only for use in safe area IP66 	<b>Description</b> Controlled heating system for use in sub-zero regions down to -50 °C. Adaptable on Schischek quarter turn actuators ..Max.. size M (depending on type). <b>Delivery:</b> 1 heating system (adaptable) <b>Ordering example:</b> ExPolar-240-MM	<b>Basics ..Polar</b> <ul style="list-style-type: none"> <li>• 24/48 VAC/DC, 120/240 VAC</li> <li>• 60 W</li> <li>• -50 °C... +50 °C</li> <li>• ExPolar for zone 1, 2, 21, 22</li> <li>• InPolar for safe area</li> </ul>



### ExPolar...-MM/InPolar...-MM

Type	Adaptable on	Operation temperature	Supply	Power*	Installation area
ExPolar...-MM	ExMax.../RedMax size M	-50 °C up to +50 °C	24 VAC/DC 48 VAC/DC 120 VAC 240 VAC	60 W	zone 1, 2, 21, 22
InPolar...-MM	InMax... size M	-50 °C up to +50 °C	24 VAC/DC 48 VAC/DC 120 VAC 240 VAC	60 W	safe area

↑ Supply voltage

\*Nominal value

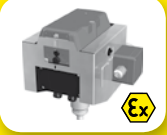
### ExPolar/InPolar Heating system for valve actuators ..Run/..Max + LIN (Preview)

Explosion proof	Industrial	Features ..Polar...-R	
<b>ExPolar...-R</b> Zone 1, 2, 21, 22 Gas + Dust certified according ATEX, IECEx 	<b>InPolar...-R</b> NOT explosion proof and only for use in safe area IP66 	<b>Description</b> Controlled heating system for use in sub-zero regions. Adaptable on Schischek valve actuators ..Run, ..Max + LIN (projected).	<b>Basics ..Polar</b> <ul style="list-style-type: none"> <li>• on request</li> <li>• subject to change</li> </ul>

### Special option

Type	Description/Technical data
...Polar...-...-CT	Housing C5-M painted, resistant against corrosive / maritime atmosphere, some parts nickel plated (surcharge)

## Introducing ExReg – HVAC control unit for hazardous locations!

VAV/CAV and pressure control applications ...



HAZARDOUS LOCATIONS ZONE 1, 2, 21, 22

DECENTRALISED CONTROL STRUCTURES

REDUCED LIFE-CYCLE-COSTS

NO INTRINSIC SAFE CIRCUITS NEEDED

INTEGRAL PID LOOP

COMPATIBILITY TO MARKET STANDARDS

PREDEFINED SETTINGS

PREDEFINED DAMPER CHARACTERISTICS

## ExReg../InReg.. Control systems – overview

### Overview of the new ExReg.. and InReg.. control systems solution

**Installation areas:**

ExReg-.....Modules for Ex-area zone 1, 2, 21, 22  
 InReg-.....Modules for safe area

**Application areas:**

ExReg/InReg-V.....Modules for volume flow control (CAV/VAV)  
 ExReg/InReg-V.....Modules for differential pressure control (ΔP)  
 ExReg/InReg-D.....Modules for temperature control  
 ExReg/InReg-D.....Modules for humidity control

**The new control systems concept offers especially in Ex-area huge benefits:**

1. Usage directly in hazardous areas in zone 1, 2, 21, 22
2. Can be configured on site in the hazardous location
3. Decentralised control structures
4. Fewer components
5. Reduced Life-Cycle-Costs
6. No necessity to install safety barriers or to use special wiring
7. Integral PID loop
8. Optional in stainless steel (AISI 316) or with C5-M painting
9. Predefined Settings and damper characteristics
10. Cost effective

VAV  
ΔP

ExReg-V

Volume flow (CAV/VAV) / Pressure ΔP

normal wiring

**ExReg-V..., InReg-V..**

Control of air flows and pressure in ventilation systems for building management control equipment, for chemical, pharmaceutical, industrial and offshore plants directly in hazardous areas zones 1, 2 (gas) and 21, 22 (dust), (InReg-V.. in safe area). To complete the technical solution on a ventilation damper (with orifice plate and known shield/k-factor) an additional actuator type ExMax...-CY or ExMax...-CYF (with fail safe spring return) is required.

°C

ExReg-D

Temperature °C

normal wiring

**ExReg-D..., InReg-D..**

Control of temperature in ventilation systems for building management control equipment, for chemical, pharmaceutical, industrial and offshore plants directly in hazardous areas zones 1, 2 (gas) and 21, 22 (dust), (InReg-D.. in safe area). To complete the technical solution an additional valve actuator type ExMax...-CY, ExMax...-CYF (with fail safe spring return) or ExRun... is required.

%rH

ExReg-D

Humidity %rH

normal wiring

**ExReg-D..., InReg-D..**

Control of humidity in ventilation systems for building management control equipment, for chemical, pharmaceutical, industrial and offshore plants directly in hazardous areas zones 1, 2 (gas) and 21, 22 (dust), (InReg-D.. in safe area). To complete the technical solution an additional valve actuator type ExMax...-CY, ExMax...-CYF (with fail safe spring return) or ExRun... is required.

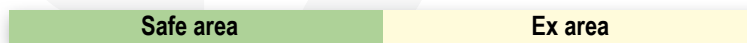

**ExReg-V../InReg-V.. Volume flow and pressure controller CAV/VAV**

VAV applications in a typical HVAC system

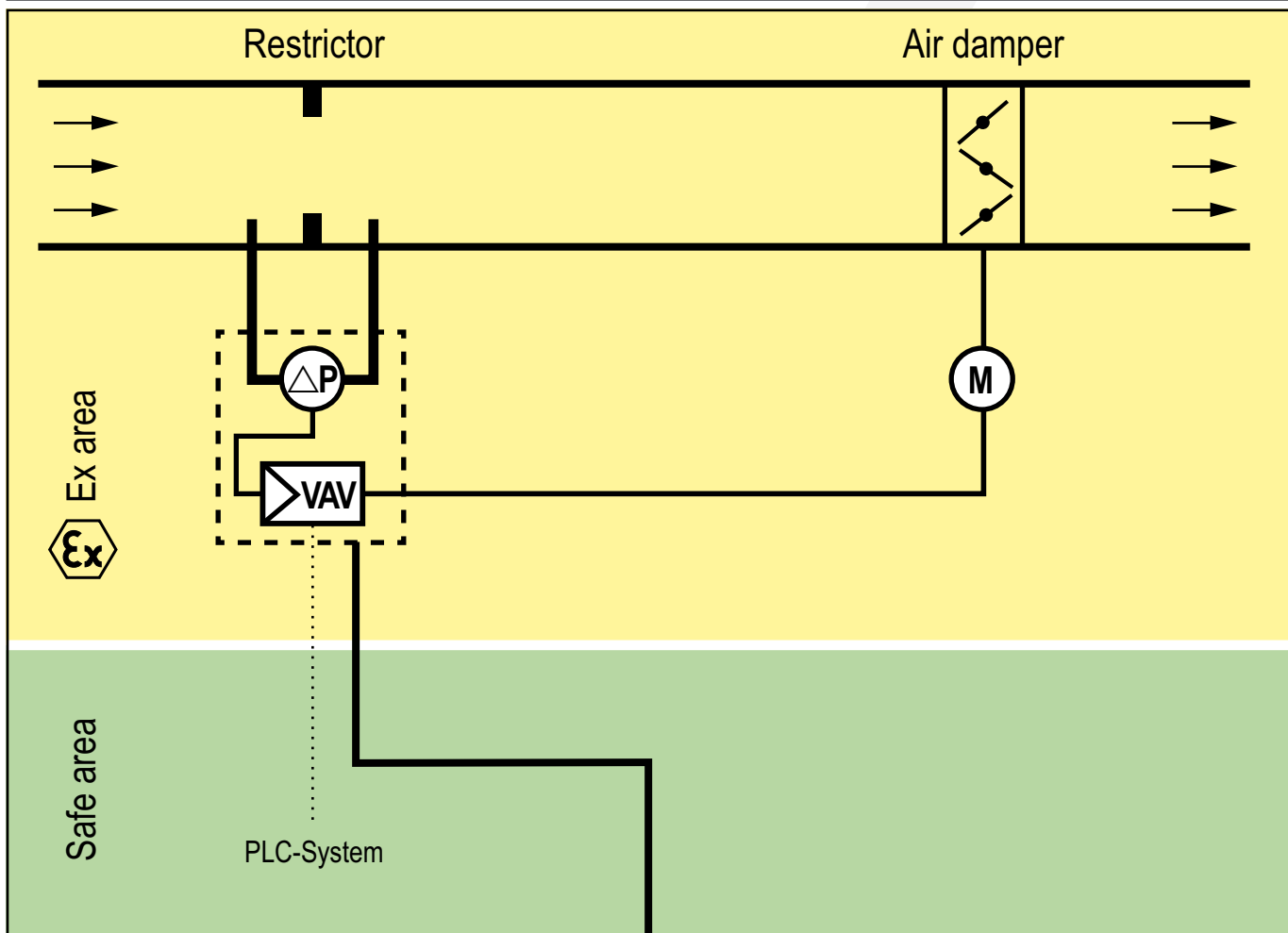



**Controller**

**ExReg-V..**  
**Differential pressure**

- 0...100/0...300 Pa,  
depending on type (VAV)



## ExReg-V../InReg-V.. Volume flow and pressure controller CAV/VAV

Explosion proof	Industrial	Features of ExReg-V.., InReg-V..	
<p><b>ExReg-V..</b></p> <p>Zone 1, 2, 21, 22 Gas + Dust certified according ATEX, IECEx</p> 	<p><b>InReg-V..</b></p> <p>NOT explosion proof and only for use in safe area IP66</p> 	<p><b>Description</b></p> <p>Compact controller for use in hazardous areas zone 1, 2, 21, 22 or in safe area (depending on type) for control/regulation of air/gas flows and pressure in ventilation systems. VAV control must be tested by the manufacturer of VAV dampers in acc. with diameter, design and characteristics of the air damper! Suitable actuator ..Max-...-CY or ..Max-...-CYF available separately.</p> <p><b>Delivery:</b> Electric volume flow/pressure controller with integrated terminal box (ExReg.. with "Ex-e"), 3 tapping screws, short circuit tube</p>	<p><b>Basics for all ..Reg-V.. controller</b></p> <ul style="list-style-type: none"> <li>• No additional module in the panel required</li> <li>• No intrinsically safe wiring required</li> <li>• Adjustable "k-factor"</li> <li>• Measurement range 0...100/0...300 Pa (depending on type)</li> <li>• 24 VAC/DC</li> <li>• Switch-on delay 3 seconds</li> <li>• Air volume monitoring</li> <li>• PID controller</li> <li>• Programmable w/o additional tools</li> <li>• Alarm with alarm delay function</li> <li>• LCD backlight (which can be switched off)</li> <li>• Aluminium housing, protection IP66</li> <li>• Integrated terminal box (ExReg.. with "Ex-e")</li> <li>• Optional "C5-M" or stainless steel edition</li> <li>• H x W x D = 180 x 107 x 66 mm</li> </ul>

### ExReg-V.. Volume flow and pressure controller for zone 1, 2, 21, 22

Type	Sensor	Supply	Meas. range	Connection/Interface (analogue)	Installation
ExReg-V100-A	Differential pressure	24 VAC/DC	0...100 Pa	1 x actuator, 1 x set point, 1 x actual value, 1 x position actuator	zone 1, 2, 21, 22
ExReg-V300-A	Differential pressure	24 VAC/DC	0...300 Pa	1 x actuator, 1 x set point, 1 x actual value, 1 x position actuator	zone 1, 2, 21, 22
ExReg-V100-B	Differential pressure	24 VAC/DC	0...100 Pa	1 x actuator, RS485 communication	zone 1, 2, 21, 22
ExReg-V300-B	Differential pressure	24 VAC/DC	0...300 Pa	1 x actuator, RS485 communication	zone 1, 2, 21, 22

### InReg-V.. Volume flow and pressure controller for safe area

Type	Sensor	Supply	Meas. range	Connection/Interface (analogue)	Installation
InReg-V100-A	Differential pressure	24 VAC/DC	0...100 Pa	1 x actuator, 1 x set point, 1 x actual value, 1 x position actuator	safe area
InReg-V300-A	Differential pressure	24 VAC/DC	0...300 Pa	1 x actuator, 1 x set point, 1 x actual value, 1 x position actuator	safe area
InReg-V100-B	Differential pressure	24 VAC/DC	0...100 Pa	1 x actuator, RS485 communication	safe area
InReg-V300-B	Differential pressure	24 VAC/DC	0...300 Pa	1 x actuator, RS485 communication	safe area

### Actuators for ..Reg-V.. controller

Type	Torque	Running time 90°	Spring return	Control mode	Feedback	Features	Size
ExMax- 5.10-CY	5 Nm / 10 Nm	7,5/15/30/60/120 sec.	-	4...20 mA	0...10 V	combination with ExReg..	S
ExMax-15.30-CY	15 Nm / 30 Nm	7,5/15/30/60/120 sec.	-	4...20 mA	0...10 V	combination with ExReg..	S
ExMax- 5.10-CYF	5 Nm / 10 Nm	7,5/15/30/60/120 sec.	~ 10 sec.	4...20 mA	0...10 V	combination with ExReg..	S
ExMax-15- CYF	15 Nm	7,5/15/30/60/120 sec.	~ 10 sec.	4...20 mA	0...10 V	combination with ExReg..	S
InMax- 5.10-CY	5 Nm / 10 Nm	7,5/15/30/60/120 sec.	-	4...20 mA	0...10 V	combination with InReg..	S
InMax- 15.30-CY	15 Nm / 30 Nm	7,5/15/30/60/120 sec.	-	4...20 mA	0...10 V	combination with InReg..	S
InMax- 5.10-CYF	5 Nm / 10 Nm	7,5/15/30/60/120 sec.	~ 10 sec.	4...20 mA	0...10 V	combination with InReg..	S
InMax- 15- CYF	15 Nm	7,5/15/30/60/120 sec.	~ 10 sec.	4...20 mA	0...10 V	combination with InReg..	S

### Accessories

Type	Technical data
MKR	Mounting bracket for installation on round air-ducts (diameter up to 600 mm)
Kit 2	Includes 2 meter pressure hose (inner diameter 6 mm) and 2 plastic fittings

Special options and offshore kits see page 52

**ExReg-D-../InReg-D-.. Temperature °C/humidity %rH controller**

Temperature and humidity applications in a typical HVAC system

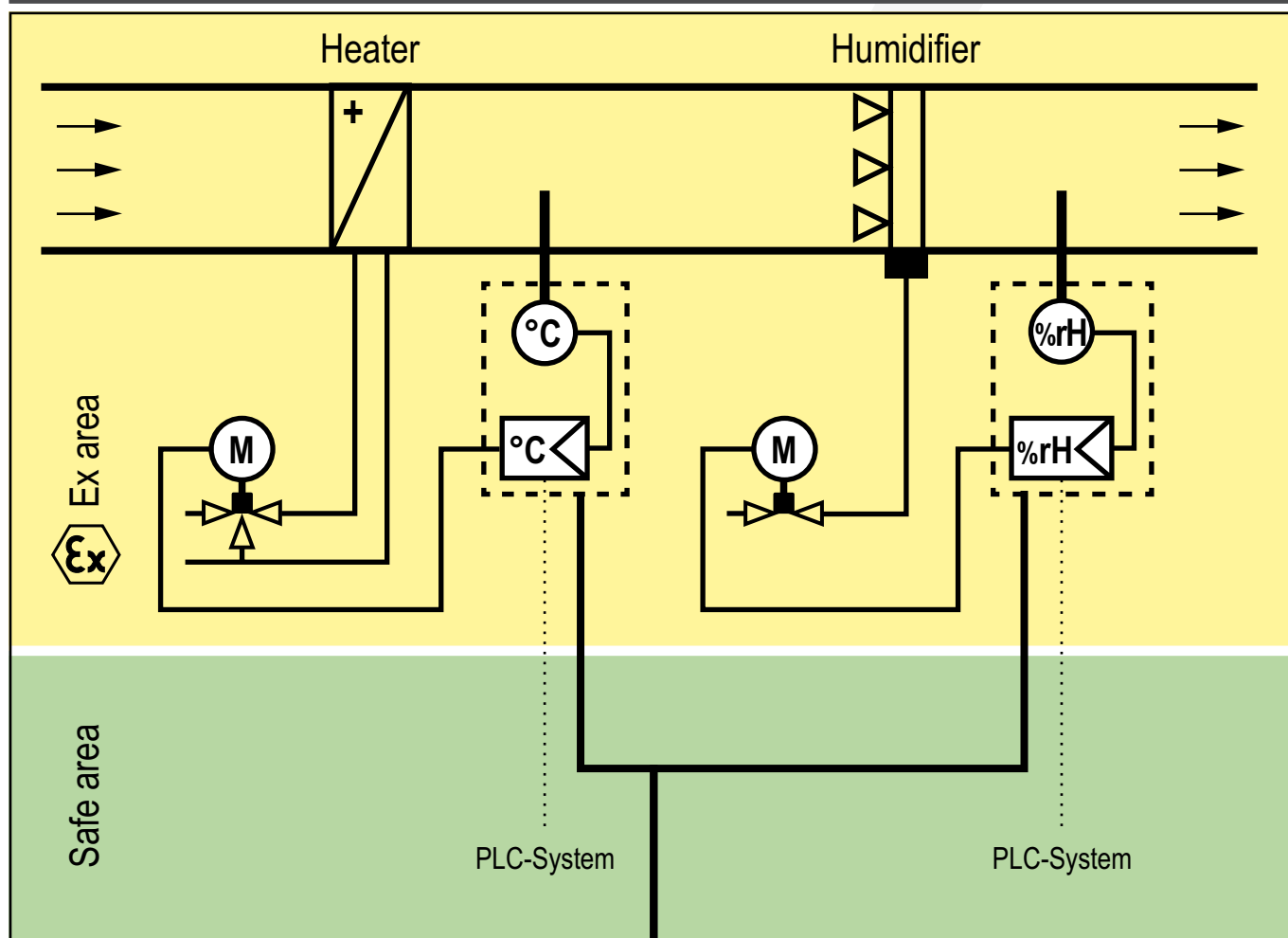



**Controller**

**ExReg-D-..  
Temperature/Humidity**

- -40°C...+125°C
- 0...100 %rH



## ExReg-D-../InReg-D-.. Temperature °C/humidity %rH controller

Explosion proof	Industrial	Features ExReg-D-..., InReg-D-..	
<p><b>ExReg-D-..</b> Zone 1, 2, 21, 22 Gas + Dust certified according ATEX, IECEx</p> 	<p><b>InReg-D-..</b> NOT explosion proof and only for use in safe area IP66</p> 	<p><b>Description</b> Compact temperature or humidity controller for use in hazardous areas zone 1, 2, 21, 22 or in safe area (depending on type). Suitable actuator ..Max-...-CY, ..Max-...-CYF or ExRun-.. available separately.</p> <p><b>Delivery:</b> Electric temperature or humidity controller with integrated terminal box (ExReg-.. with "Ex-e") and connection for 1 ExPro-C-../InPro-C-.. sensor probe, 3 tapping screws</p>	<p><b>Basics for all ..Reg-D-.. controller</b></p> <ul style="list-style-type: none"> <li>• No additional module in the panel required</li> <li>• No intrinsically safe wiring required</li> <li>• Meas. range -40...+125 °C/0...100 %rH</li> <li>• 24 VAC/DC</li> <li>• Switch-on delay 3 seconds</li> <li>• PID controller</li> <li>• Programmable w/o additional tools</li> <li>• Alarm with alarm delay function</li> <li>• LCD backlight (which can be switched off)</li> <li>• Aluminium housing, protection IP66</li> <li>• Integrated terminal box (ExReg-.. with "Ex-e")</li> <li>• Optional "C5-M" or stainless steel edition</li> <li>• H × W × D = 180 × 107 × 66 mm</li> </ul>

### ExReg-D-.. Temperature/humidity controller for zone 1, 2, 21, 22

Type	Sensor	Supply	Meas. range	Connection/Interface (analogue)	Installation
ExReg-D-A	ExPro-C-..	24 VAC/DC	-40...+125 °C/0...100 %rH	1 × actuator, 1 × set point, 1 × actual value, 1 × position actuator	zone 1, 2, 21, 22
ExReg-D-B	ExPro-C-..	24 VAC/DC	-40...+125 °C/0...100 %rH	1 × actuator, RS485 communication	zone 1, 2, 21, 22

### InReg-D-.. Temperature/humidity controller for safe area

Type	Sensor	Supply	Meas. range	Connection/Interface (analogue)	Installation
InReg-D-A	InPro-C-..	24 VAC/DC	-40...+125 °C/0...100 %rH	1 × actuator, 1 × set point, 1 × actual value, 1 × position actuator	safe area
InReg-D-B	InPro-C-..	24 VAC/DC	-40...+125 °C/0...100 %rH	1 × actuator, RS485 communication	safe area

### Actuators for ..Reg-V300-.. controller

Type	Torque	Running time 90°	Spring return	Control mode	Feedback	Features	Size
ExMax- 5.10-CY	5 Nm / 10 Nm	7,5/15/30/60/120 sec.	-	4...20 mA	0...10 V	combination with ExReg-V-..	S
ExMax-15.30-CY	15 Nm / 30 Nm	7,5/15/30/60/120 sec.	-	4...20 mA	0...10 V	combination with ExReg-V-..	S
ExMax- 5.10-CYF	5 Nm / 10 Nm	7,5/15/30/60/120 sec.	~ 10 sec.	4...20 mA	0...10 V	combination with ExReg-V-..	S
ExMax-15- CYF	15 Nm	7,5/15/30/60/120 sec.	~ 10 sec.	4...20 mA	0...10 V	combination with ExReg-V-..	S
InMax- 5.10-CY	5 Nm / 10 Nm	7,5/15/30/60/120 sec.	-	4...20 mA	0...10 V	combination with InReg-V-..	S
InMax- 15.30-CY	15 Nm / 30 Nm	7,5/15/30/60/120 sec.	-	4...20 mA	0...10 V	combination with InReg-V-..	S
InMax- 5.10-CYF	5 Nm / 10 Nm	7,5/15/30/60/120 sec.	~ 10 sec.	4...20 mA	0...10 V	combination with InReg-V-..	S
InMax- 15- CYF	15 Nm	7,5/15/30/60/120 sec.	~ 10 sec.	4...20 mA	0...10 V	combination with InReg-V-..	S

### Sensor probes for ..Reg-D-.. controller

Type	Technical data
ExPro-CT-..	Temperature sensor probe for connection on ExReg-D-.. controller, installation in zone 1, 2, 21, 22
ExPro-CF-..	Humidity sensor probe for connection on ExReg-D-.. controller, installation in zone 1, 2, 21, 22
InPro- CT-..	Temperature sensor probe for connection on InReg-D-.. controller, installation in safe area
InPro- CF-..	Humidity sensor probe for connection on InReg-D-.. controller, installation in safe area

Combi sensor probes not applicable!  
For more details about ExPro-C-../InPro-C-.. see page 39

### Accessories

Type	Technical data
MKR	Mounting bracket for installation on round air-ducts (diameter up to 600 mm)

Special options and offshore kits see page 52

## Introducing ExCos – Modulating sensor series for hazardous locations!

Differential pressure, temperature and humidity measurement applications ...



HAZARDOUS LOCATIONS ZONE 1, 2, 21, 22

NO TRANSDUCER IN PANEL NEEDED

NO INTRINSIC SAFE CIRCUITS NEEDED

EASY INSTALLATION

EASY PARAMETERISATION

REDUCED INSTALLATION COST

ACTUAL VALUE INDICATION

C5-M OFFSHORE VERSION

STAINLESS STEEL SOLUTION



## Table of contents

Product series		Page	Installation areas in zone						
			Gas 0	Dust 20	Gas 1	Dust 21	Gas 2	Dust 22	SA*
<b>Modulating sensors for temperature, humidity, pressure/differential pressure</b>									
Overview	modulating sensors	32/36							
<b>NEW</b>	ExCos-V	volume flow and pressure transducer	0... 300 Pa		●	●	●	●	
<b>NEW</b>	RedCos-V	volume flow and pressure transducer	0... 300 Pa				●	●	
<b>NEW</b>	InCos-V	volume flow and pressure transducer	0... 300 Pa (not Ex)						●
	ExCos-P	differential pressure, VAV sensors	± 100... 7.500 Pa		●	●	●	●	
	RedCos-P	differential pressure, VAV sensors	± 100... 7.500 Pa				●	●	
	InCos-P	differential pressure, VAV sensors	± 100... 7.500 Pa (not Ex)						●
	ExCos-D	temperature and humidity transducer for ExPro-C... sensors			●	●	●	●	
	RedCos-D	temperature and humidity transducer for ExPro-C... sensors					●	●	
	InCos-D	temperature and humidity transducer for InPro-C... sensors (not Ex)							●
	ExPro-C...	temperature and humidity sensor probes for operation in HVAC systems			●	●	●	●	
	InPro-C...	temperature and humidity sensor probes for operation in HVAC systems (not Ex)							●
	ExCos-A	transducer for passive, potential free, modulating ExSens sensors			●	●	●	●	
	RedCos-A	transducer for passive, potential free, modulating ExSens sensors					●	●	
	InCos-A	transducer for passive, potential free, modulating sensors (not Ex)							●
	ExLine	transducer EXL-IMU-1 for passive, potential free, modulating ExSens sensors							●
	ExSens	modulating, passive temperature-/humidity-/pressure sensors		(●)	●	(●)	●	●	
<b>Special options for sensors</b>									
Overview	special options for sensors	52							
Overview	heating system ExPolar for sensors	53							
ExPolar	heating system for sensors' use in Ex areas down to -50 °C	53			●	●	●	●	
InPolar	heating system for sensors' use in safe area down to -50 °C (not Ex)	53							●

\*SA = Safe area  
 (●) = on request

## Introducing ExCos-V – Volume flow transducer for hazardous locations !

Volume flow applications ...

**NEW**



HAZARDOUS LOCATIONS ZONE 1, 2, 21, 22

ACTUAL VALUE INDICATION

STATUS LED's

NO INTRINSIC SAFE CIRCUITS NEEDED



ALARM MONITORING

COMPATIBILITY TO MARKET STANDARDS

PREDEFINED SETTINGS

REDUCED LIFE-CYCLE COSTS

## ExCos-V/RedCos-V/InCos-V Volume flow transducer

Explosion proof		Industrial	Features of ExCos-V, RedCos-V, InCos-V	
<b>ExCos-V...</b> Zone 1, 2, 21, 22 Gas + Dust certified according ATEX  	<b>RedCos-V...</b> Zone 2, 22 Gas + Dust certified according ATEX  	<b>InCos-V...</b> NOT Explosion proof and only for use in safe area IP66  	<b>Description</b> Compact volume flow or pressure transducer for use in hazardous areas zone 1, 2, 21, 22 or in safe area (depending on type) for measuring of volume flows in ventilation systems. Volume flow measurement must be tested by the manufacturer of dampers in acc. with diameter, design and characteristics of the air damper!  <b>Delivery:</b> Electric volume flow or pressure transducer with integrated terminal box (ExCos-V.. with "Ex-e"), 3 tapping screws, short circuit tube	<b>Basics for all ...Cos-V transducers</b> <ul style="list-style-type: none"> <li>• No additional module in the panel required</li> <li>• No intrinsically safe wiring required</li> <li>• Adjustable "k-factor"</li> <li>• Measurement range 0...100/0...300 Pa (depending on type)</li> <li>• 24 VAC/DC</li> <li>• Switch-on delay 3 seconds</li> <li>• Air volume monitoring</li> <li>• Alarm monitoring</li> <li>• Additional switching contact</li> <li>• Programmable w/o additional tools</li> <li>• LCD backlight (which can be switched off)</li> <li>• Aluminium housing, protection IP66</li> <li>• Integrated terminal box (ExCos-V.. with "Ex-e")</li> <li>• Optional "C5-M" or stainless steel edition</li> <li>• H x W x D = 180 x 107 x 66 mm</li> </ul>

### ExCos-V... Volume flow and pressure transducer for zone 1, 2, 21, 22

Type	Sensor	Supply	Meas. range	Connection/Interface (analogue)	Installation
ExCos-V100	Differential pressure	24 VAC/DC	0...100 Pa	1 x 0(4)...20 mA, 1 x 0(2)...10 V, 1 x Relais	zone 1, 2, 21, 22
ExCos-V300	Differential pressure	24 VAC/DC	0...300 Pa	1 x 0(4)...20 mA, 1 x 0(2)...10 V, 1 x Relais	zone 1, 2, 21, 22

### RedCos-V... Volume flow and pressure transducer for zone 2, 22

Type	Sensor	Supply	Meas. range	Connection/Interface (analogue)	Installation
RedCos-V100	Differential pressure	24 VAC/DC	0...100 Pa	1 x 0(4)...20 mA, 1 x 0(2)...10 V, 1 x Relais	zone 2, 22
RedCos-V300	Differential pressure	24 VAC/DC	0...300 Pa	1 x 0(4)...20 mA, 1 x 0(2)...10 V, 1 x Relais	zone 2, 22

### InCos-V... Volume flow and pressure transducer for safe area

Type	Sensor	Supply	Meas. range	Connection/Interface (analogue)	Installation
InCos-V100	Differential pressure	24 VAC/DC	0...100 Pa	1 x 0(4)...20 mA, 1 x 0(2)...10 V, 1 x Relais	safe area
InCos-V300	Differential pressure	24 VAC/DC	0...300 Pa	1 x 0(4)...20 mA, 1 x 0(2)...10 V, 1 x Relais	safe area

### Accessories

Type	Technical data
MKR	Mounting bracket for installation on round air-ducts (diameter up to 600 mm)
Kit 2	Includes 2 meter pressure hose (inner diameter 6 mm) and 2 plastic fittings

Special options and offshore kits see page 52

## ExCos../RedCos../InCos.. Sensors – Overview

### The new ExCos..., RedCos and InCos Sensor-Technology

**Installation areas:**

- ExCos- .....Sensors for Ex-area zone 1, 2, 21, 22
- RedCos- .....Sensors for Ex-area zone 2, 22
- InCos- .....Sensors for safe area

**Application areas:**

- Ex/Red/InCos-V .....sensors for volume flow measurement
- Ex/Red/InCos-P .....sensors for pressure and differential pressure
- Ex/Red/InCos-D + ..Pro-C .....active sensor-heads for temperature and/or humidity
- Ex/Red/InCos-A + ..Sens .....passive sensors for temperature, humidity and potentiometer

**The sensor concept offers especially in Ex-area huge benefits:**

1. No intrinsically safe wiring required between the control panel and the sensor
2. No intrinsically safe circuit necessary inside the control panel
3. No transducer needed in the electrical control panel
4. Reduced installation cost
5. Easy installation
6. Easy parameterisation
7. Cost savings for electrical components
8. Actual value indication
9. Optional in stainless steel (AISI 316) or with C5-M painting

#### Volume flow, Pressure, Differential Pressure – modulating, active

$\Delta P$  ExCos-V



normal wiring

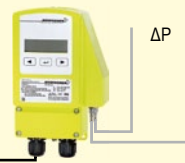

**ExCos-V., RedCos-V., InCos-V. Sensors**

Volume flow transducers with integrated differential-pressure sensor for direct connection of the air-hoses. IP66 aluminium housing with integrated terminal-box. Measuring range parametrizable on site. Outputs 0...10V VDC/4...20 mA. Integrated actual value indication, parametrizable and illuminated.

#### Pressure, Differential Pressure, VAV – modulating, active

$\Delta P$  ExCos-P



normal wiring

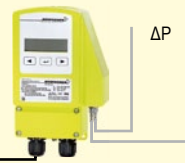

**ExCos-P., RedCos-P., InCos-P. Sensors**

Transducers with integrated differential-pressure sensor for direct connection of the air-hoses. IP66 aluminium housing with integrated terminal-box. Measuring range parametrizable on site. Outputs 0...10V VDC/4...20 mA. Integrated actual value indication, illuminated.

#### Temperature and/or Humidity – modulating, active

$^{\circ}C$   
 $\%rH$  ExCos-D  
+ ExPro-C..



normal wiring

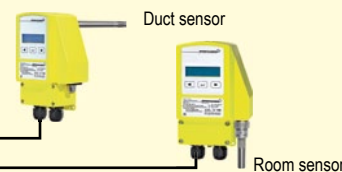

**ExCos-D., RedCos-D., InCos-D..**

**Transducer + ExPro-C., InPro-C.. sensor probe**

Transducer for the installation of an ExPro-C.. or InPro-C.. (with InCos-D) for temperature  $^{\circ}C$  and/or humidity in %. IP66 aluminium housing with integrated terminal box. Measuring range parametrizable on site. Outputs 0...10V VDC/4...20 mA. Integrated actual value indication, illuminated.

#### Temperature and/or Humidity, Potentiometer – modulating, passive

$^{\circ}C$   
 $\%rH$  ExCos-A  
+ ExSens



normal wiring



**ExCos-A., RedCos-A., InCos-A..**

**Transducer + ExSens sensor**

Transducer for a connection of a passive, modulating ExSens sensor type Pt 100, Ni 1000, 0...10 k $\Omega$  over Ex-i electrical conduit. IP66 aluminium housing with integrated terminal box. Measuring range parametrizable on site. Outputs 0...10V VDC/4...20 mA. Integrated actual value indication, illuminated.

#### Temperature, Humidity, Potentiometer – modulating, passive

$^{\circ}C$   
 $\%rH$  EXL-IMU-1  
+ ExSens



normal wiring

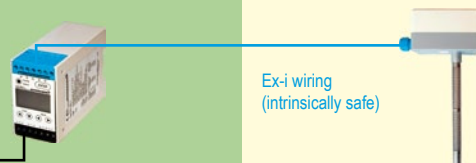



**EXL-IMU-1 transducer + ExSens sensor**

Transducer for a connection of a passive, modulating ExSens sensor type Pt 100, Ni 1000, 0...10 k $\Omega$  over Ex-i electrical conduit. Installation in control box onto DIN-rail. Measuring range parametrizable on site. Outputs 0...10V VDC/4...20 mA. Integrated actual value indication.

Safe area

Ex area

## ExCos-P/RedCos-P/InCos-P Differential pressure transducers

Explosion proof		Industrial	Features of ExCos-P, RedCos-P, InCos-P	
<b>ExCos-P...</b> Zone 1, 2, 21, 22 Gas + Dust certified according ATEX, IECEx, GOST-R, RTN, KOSHA 	<b>RedCos-P...</b> Zone 2, 22 Gas + Dust certified according ATEX, GOST-R, RTN, CSA 	<b>InCos-P...</b> NOT Explosion proof and only for use in safe area IP66 	<b>Description</b> ExCos-P, RedCos-P and InCos-P are pressure transducers for HVAC systems, e.g. for differential pressure control.  <b>Delivery:</b> 1 sensor with integrated terminal box, 3 tapping screws, short circuit tube	<b>Basics for all ...Cos-P transducers</b> <ul style="list-style-type: none"> <li>• No additional module in the panel required!</li> <li>• No intrinsically safe wiring required!</li> <li>• 24 VAC/DC supply</li> <li>• Outputs 0...10 V, (0)4...20 mA selectable</li> <li>• Measurement range adjustable</li> <li>• Actual value indication (which can be switched off)</li> <li>• All parameters can be adjusted on site without additional tools and measurement devices</li> <li>• Aluminium housing IP66</li> <li>• Integrated terminal box</li> <li>• Dimensions (H x W x D) 180 x 107 x 66 mm</li> </ul>

### ExCos-P... Differential pressure and volume control transducers for zone 1, 2, 21, 22

Type	Max. range	Overload protected	Measurement range, min. 20% of max. range	Installation module
ExCos-P- 100	± 100 Pa	up to 25.000 Pa	± Measurement range free adjustable, min. range 20 Pa	zone 1, 2, 21, 22
ExCos-P- 250	± 250 Pa	up to 25.000 Pa	± Measurement range free adjustable, min. range 50 Pa	zone 1, 2, 21, 22
ExCos-P- 500	± 500 Pa	up to 50.000 Pa	± Measurement range free adjustable, min. range 100 Pa	zone 1, 2, 21, 22
ExCos-P-1250	± 1.250 Pa	up to 50.000 Pa	± Measurement range free adjustable, min. range 250 Pa	zone 1, 2, 21, 22
ExCos-P-2500	± 2.500 Pa	up to 50.000 Pa	± Measurement range free adjustable, min. range 500 Pa	zone 1, 2, 21, 22
ExCos-P-5000	± 5.000 Pa	up to 75.000 Pa	± Measurement range free adjustable, min. range 1.000 Pa	zone 1, 2, 21, 22
ExCos-P-7500	± 7.500 Pa	up to 120.000 Pa	± Measurement range free adjustable, min. range 1.500 Pa	zone 1, 2, 21, 22

### RedCos-P... Differential pressure and volume control transducers for zone 2, 22

Type	Max. range	Overload protected	Measurement range, min. 20% of max. range	Installation module
RedCos-P- 100	± 100 Pa	up to 25.000 Pa	± Measurement range free adjustable, min. range 20 Pa	zone 2, 22
RedCos-P- 250	± 250 Pa	up to 25.000 Pa	± Measurement range free adjustable, min. range 50 Pa	zone 2, 22
RedCos-P- 500	± 500 Pa	up to 50.000 Pa	± Measurement range free adjustable, min. range 100 Pa	zone 2, 22
RedCos-P-1250	± 1.250 Pa	up to 50.000 Pa	± Measurement range free adjustable, min. range 250 Pa	zone 2, 22
RedCos-P-2500	± 2.500 Pa	up to 50.000 Pa	± Measurement range free adjustable, min. range 500 Pa	zone 2, 22
RedCos-P-5000	± 5.000 Pa	up to 75.000 Pa	± Measurement range free adjustable, min. range 1.000 Pa	zone 2, 22
RedCos-P-7500	± 7.500 Pa	up to 120.000 Pa	± Measurement range free adjustable, min. range 1.500 Pa	zone 2, 22

### InCos-P... Differential pressure and volume control transducers for safe area

Type	Max. range	Overload protected	Measurement range, min. 20% of max. range	Installation module
InCos-P- 100	± 100 Pa	up to 25.000 Pa	± Measurement range free adjustable, min. range 20 Pa	safe area
InCos-P- 250	± 250 Pa	up to 25.000 Pa	± Measurement range free adjustable, min. range 50 Pa	safe area
InCos-P- 500	± 500 Pa	up to 50.000 Pa	± Measurement range free adjustable, min. range 100 Pa	safe area
InCos-P-1250	± 1.250 Pa	up to 50.000 Pa	± Measurement range free adjustable, min. range 250 Pa	safe area
InCos-P-2500	± 2.500 Pa	up to 50.000 Pa	± Measurement range free adjustable, min. range 500 Pa	safe area
InCos-P-5000	± 5.000 Pa	up to 75.000 Pa	± Measurement range free adjustable, min. range 1.000 Pa	safe area
InCos-P-7500	± 7.500 Pa	up to 120.000 Pa	± Measurement range free adjustable, min. range 1.500 Pa	safe area

### Accessories and special designs

Type	Technical data
Ex/RedCos-P.-A	Version with one additional intrinsically safe circuit (0)4...20 mA output to connect external actual value indicator in Ex areas (surcharge)
InCos-P.-A	Version with one additional (0)4...20 mA output to connect external actual value indicator in safe area (surcharge)
EXC-RIA-16	Intrinsic safe actual value LCD indicator, for use in zone 1, 2, 21, 22, connectable to ExCos-P.-A or RedCos-P.-A transducers
NOC-RIA-16	LCD indicator, connectable to InCos-P.-A transducers
MKR	Mounting bracket for installation on round air-ducts (diameter up to 600 mm)
Kit 2	Includes 2 meter pressure hose (inner diameter 6 mm) and 2 plastic fittings

Special options and offshore kits see page 52

## ExCos-D/RedCos-D/InCos-D Temperature/humidity transducer

Explosion proof		Industrial	Features ExCos-D, RedCos-D, InCos-D	
<b>ExCos-D...</b> Zone 1, 2, 21, 22 Gas + Dust certified according ATEX, IECEx, GOST-R, RTN, KOSHA	<b>RedCos-D...</b> Zone 2, 22 Gas + Dust certified according ATEX, GOST-R, RTN, CSA	<b>InCos-D...</b> NOT Explosion proof and only for use in safe area IP66	<b>Description</b> ExCos-D, RedCos-D and InCos-D transducer together with ExPro-C.../InPro-C... digital sensors are for temperature and/or humidity measurement in HVAC systems. <b>Delivery:</b> 1 transducer with connection for 1 ExPro-C... sensor, 3 tapping screws <b>Required accessory (additional price):</b> 1 ExPro-C... or InPro-C... sensor <b>Ordering example</b> for 1 temperature duct sensing, 150 mm sensor tube, additional external value indication, sensor in zone 21, indicator in zone 22. <b>Types to order:</b> 1 × ExCos-D + type addition ...-A (Ex-i transducer) 1 × ExPro-CT-150 + (Ex-i sensor) 1 × EXC-RIA-16 (Ex-i indicator)	<b>Basics for all ...Cos-D sensors</b> <ul style="list-style-type: none"> <li>• No additional module in the panel required!</li> <li>• No intrinsically safe wiring required!</li> <li>• 24 VAC/DC supply</li> <li>• Connector for ExPro-C... sensors for room or duct mounting</li> <li>• Outputs 0...10 V, 4...(0)20 mA selectable</li> <li>• Measurement range adjustable</li> <li>• Actual value indication (which can be switched off)</li> <li>• All parameters can be adjusted on site without additional tools and measurement devices</li> <li>• Aluminium housing IP66</li> <li>• Integrated terminal box</li> <li>• Dimensions (H × W × D) 180 × 107 × 66 mm</li> </ul>

### ExCos-D temperature-/humidity module for zone 1, 2, 21, 22

Type	Technical data	Installation module	Installation ExPro sensor
ExCos-D	Module to connect 1 ExPro-C... sensor for temperature and/or humidity for use in hazardous areas	zone 1, 2, 21, 22	zone 1, 2, 21, 22

### RedCos-D temperature-/humidity module for zone 2, 22

Type	Technical data	Installation module	Installation ExPro sensor
RedCos-D	Module to connect 1 ExPro-C... sensor for temperature and/or humidity for use in hazardous areas	zone 2, 22	zone 1, 2, 21, 22

### InCos-D temperature-/humidity module for safe area

Type	Technical data	Installation module	Installation InPro sensor
InCos-D	Module to connect 1 InPro-C... sensor for temperature and/or humidity for use in safe area	safe area	safe area

### Accessories and special designs

Type	Technical data
Ex/RedCos-D-A	Version with two* additional intrinsic safe circuit (0)4...20 mA outputs to connect external actual value indicator in Ex areas (surcharge)
InCos-D-A	Version with two* additional (0)4...20 mA outputs to connect external actual value indicator in safe area (surcharge)
EXC-RIA-16	Intrinsic safe actual value LCD indicator, for use in zone 1, 2, 21, 22, connectable to ExCos-D-A or RedCos-D-A transducers
NOC-RIA-16	Actual value LCD indicator, for use in safe area, connectable to InCos-D-A transducers
InCal-D	Electrical calibration for temperature and humidity measurement for connecting ExCos-D, RedCos-D, InCos-D transducers, adjustable in 5 C / 5 %rH steps
MKR	Mounting bracket for installation on round air-ducts (diameter up to 600 mm)
VL3	Sensor extension cable 3 m

\*Output 1 = for °C, Output 2 = for %rH | Special options and offshore kits see page 52

### Example of combinations

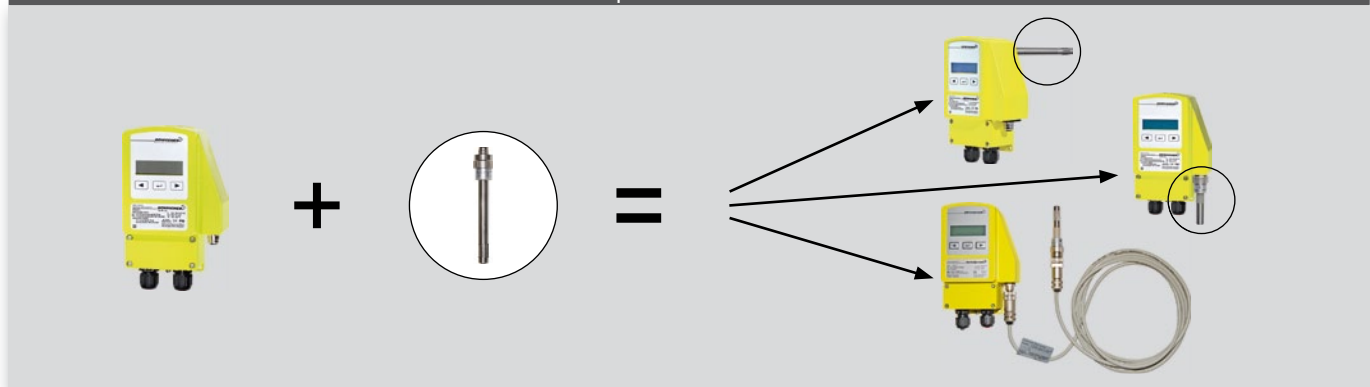

## ExPro-C.../InPro-C... Digital temperature/humidity sensors

### Explosion proof

### Industrial

### Features ExPro-C..., InPro-C...

#### ExPro-C...

Zone 1, 2, 21, 22  
Gas + Dust  
certified according  
ATEX, IECEx  
PTB-certified in acc.  
with ExCos-D/RedCos-D  
transducer



#### InPro-C...

Only for use with  
InCos-D... transducers!  
**NOT** for use in  
Ex area!



#### Description

ExPro-C... sensors are used for measurements of temperature and/or humidity in hazardous areas, for **exclusive** use with ExCos-D... / RedCos-D... transducers!

InPro-C... sensors are suitable for temperature and/or humidity measurement in safe areas, for **exclusive** use with InCos-D... transducers!

**Delivery:** 1 sensor with connector

**Example:** room-humidity sensor, 50 mm length  
**Type:** 1 x ExPro-CF-50

**Attention:** only in combination with:  
1 x ExCos-D or RedCos-D  
(InCos-D by InPro-C... sensors)

#### Basics for all ExPro-C.../InPro-C... sensors

- Sensors for connection to ExCos-D..., RedCos-D... transducers. Mechanical and electrical adaptation via connector
- ExPro-C.../InPro-C... sensors can be screwed to the housing optionally at the back (duct measurement) or bottom (room measurement)
- When using humidity-sensors, the contamination and aggressiveness of the medium has to be regarded

### Sensor probes for ExCos-D and RedCos-D transducer

Type	Function	Range	Sensor length	Main use	Connectable to	Installation area
ExPro-CT - 50	Temperature sensor	-40...+ 80 °C	50 mm	Room/Duct	ExCos-D RedCos-D	zone 1, 2, 21, 22
ExPro-CT -100	Temperature sensor	-40...+ 125 °C	100 mm	Duct	ExCos-D RedCos-D	zone 1, 2, 21, 22
ExPro-CT -150	Temperature sensor	-40...+ 125 °C	150 mm	Duct	ExCos-D RedCos-D	zone 1, 2, 21, 22
ExPro-CT -200	Temperature sensor	-40...+ 125 °C	200 mm	Duct	ExCos-D RedCos-D	zone 1, 2, 21, 22
ExPro-CF - 50	Humidity sensor	0...100 %rF	50 mm	Room/Duct	ExCos-D RedCos-D	zone 1, 2, 21, 22
ExPro-CF -100	Humidity sensor	0...100 %rF	100 mm	Duct	ExCos-D RedCos-D	zone 1, 2, 21, 22
ExPro-CF -150	Humidity sensor	0...100 %rF	150 mm	Duct	ExCos-D RedCos-D	zone 1, 2, 21, 22
ExPro-CF -200	Humidity sensor	0...100 %rF	200 mm	Duct	ExCos-D RedCos-D	zone 1, 2, 21, 22
ExPro-CTF- 50	Combination temperature/humidity	-40...+ 80 °C, 0...100 %rH	50 mm	Room/Duct	ExCos-D RedCos-D	zone 1, 2, 21, 22
ExPro-CTF-100	Combination temperature/humidity	-40...+ 125 °C, 0...100 %rH	100 mm	Duct	ExCos-D RedCos-D	zone 1, 2, 21, 22
ExPro-CTF-150	Combination temperature/humidity	-40...+ 125 °C, 0...100 %rH	150 mm	Duct	ExCos-D RedCos-D	zone 1, 2, 21, 22
ExPro-CTF-200	Combination temperature/humidity	-40...+ 125 °C, 0...100 %rH	200 mm	Duct	ExCos-D RedCos-D	zone 1, 2, 21, 22



### Sensor probes for InCos-D transducer

Type	Function	Range	Sensor length	Main use	Connectable to	Installation area
InPro-CT - 50	Temperature sensor	-40...+ 80 °C	50 mm	Room/Duct	InCos-D	safe area
InPro-CT -100	Temperature sensor	-40...+ 125 °C	100 mm	Duct	InCos-D	safe area
InPro-CT -150	Temperature sensor	-40...+ 125 °C	150 mm	Duct	InCos-D	safe area
InPro-CT -200	Temperature sensor	-40...+ 125 °C	200 mm	Duct	InCos-D	safe area
InPro-CF - 50	Humidity sensor	0...100 %rF	50 mm	Room/Duct	InCos-D	safe area
InPro-CF -100	Humidity sensor	0...100 %rF	100 mm	Duct	InCos-D	safe area
InPro-CF -150	Humidity sensor	0...100 %rF	150 mm	Duct	InCos-D	safe area
InPro-CF -200	Humidity sensor	0...100 %rF	200 mm	Duct	InCos-D	safe area
InPro-CTF- 50	Combination temperature/humidity	-40...+ 80 °C, 0...100 %rH	50 mm	Room/Duct	InCos-D	safe area
InPro-CTF-100	Combination temperature/humidity	-40...+ 125 °C, 0...100 %rH	100 mm	Duct	InCos-D	safe area
InPro-CTF-150	Combination temperature/humidity	-40...+ 125 °C, 0...100 %rH	150 mm	Duct	InCos-D	safe area
InPro-CTF-200	Combination temperature/humidity	-40...+ 125 °C, 0...100 %rH	200 mm	Duct	InCos-D	safe area

### Accessories

Type	Technical data
MFK	Mounting flange for duct-installation, for variable depth of immersion in the air duct
TH- VA	Probe made of stainless-steel V4A 1.4571, length 150 mm for ..Pro-CT-200. Other lengths on request
Kit-FA-VA	Sinter filter cap for humidity sensor (only up to 90 %rH)
MKR	Mounting bracket for installation on round air-ducts (diameter up to 600 mm)

## ExCos-A/RedCos-A/InCos-A Temperature/humidity transducer

Explosion proof		Industrial	Features of ExCos-A, RedCos-A, InCos-A	
<b>ExCos-A...</b> Zone 1, 2, 21, 22 Gas + Dust certified according ATEX, IECEx, GOST-R, RTN, KOSHA	<b>RedCos-A...</b> Zone 2, 22 Gas + Dust certified according ATEX, GOST-R, RTN, CSA	<b>InCos-A...</b> NOT Explosion proof and only for use in safe area IP66	<b>Description</b> ExCos-A, RedCos-A and InCos-A transducer together with modulating ExSens passive sensors are for temperature or humidity measurement in HVAC systems. <b>Delivery:</b> 1 transducer with connection for modulating, 3 tapping screws <b>Required accessory (additional price):</b> 1 ExSens sensor, see next page <b>Ordering example</b> for measuring of temperature in air duct, with Pt 100 in zone 1. <b>Types to order:</b> 1 × ExCos-A (Ex-i transducer) 1 × TFR-2G (Ex-i sensor)	<b>Basics for all ...Cos-A transducer</b> <ul style="list-style-type: none"> <li>• No additional module in the panel required!</li> <li>• No intrinsically safe wiring required!</li> <li>• 24 VAC/DC supply</li> <li>• Connector for 1 ExSens sensor for room or duct mounting</li> <li>• Outputs: 0...10 V, (0)4...20 mA selectable</li> <li>• Input: Pt 100, Pt 500, Pt 1000, Ni 100, Ni 200, Ni 500, Ni 1000, Ni 1000 Siemens, KP 250, Passive sensors with resistance output 0...1.000 Ohm, 0...10.000 Ohm</li> <li>• Measuring range adjustable</li> <li>• Actual value indication (which can be switched off)</li> <li>• All parameters can be adjusted on site without additional tools and measurement devices</li> <li>• Aluminium housing IP66</li> <li>• Integrated terminal box</li> <li>• Dimensions (H × W × D) 180 × 107 × 66 mm</li> </ul>
				

### ExCos-A transducer for passive sensors for zone 1, 2, 21, 22

Type	Technical data	Installation module	Installation sensor*
ExCos-A	Module to connect 1 modulating ExSens sensor for temperature or humidity for use in hazardous areas	zone 1, 2, 21, 22	zone 0, 1, 2, 20, 21, 22

\* in acc. with certification of sensor!

### RedCos-A transducer for passive sensors for zone 2, 22

Type	Technical data	Installation module	Installation sensor*
RedCos-A	Module to connect 1 modulating ExSens sensor for temperature or humidity for use in hazardous areas	zone 2, 22	zone 0, 1, 2, 20, 21, 22

\* in acc. with certification of sensor!

### InCos-A transducer for passive sensors for safe area

Type	Technical data	Installation module	Installation sensor
InCos-A	Module to connect 1 modulating sensor for temperature or humidity for use in safe area Sensors: all passive sensors like Pt 100, Pt 1000, Ni 100, 200, 1000 ...	safe area	safe area

### Accessories and special designs

Type	Technical data
Ex/RedCos-A-A	Version with one additional intrinsically safe circuit (0)4...20 mA output to connect external actual value indicator in Ex areas (surcharge)
InCos-A-A	Version with one additional (0)4...20 mA output to connect external indicator in safe area (surcharge)
EXC-RIA-16	Intrinsic safe actual value LCD indicator, for use in zone 1, 2, 21, 22, connectable to ExCos-A-A or RedCos-A-A sensors
NOC-RIA-16	Actual value LCD indicator, for use in safe area, connectable to InCos-A-A sensors
MKR	Mounting bracket for installation on round air-ducts (diameter up to 600 mm)

Special options and offshore kits see page 52



## ExLine Ex-transducer with Ex-i circuit for zone 0, 1, 2, 20, 21, 22

Explosion proof		Features EXL-IMU-1	
<b>EXL-IMU-1</b> Zone 0, 1, 2, 20, 21, 22 Gas + Dust certified according ATEX	<b>EXL-IMU-1</b> 	<b>Description</b> EXL-IMU-1 module with intrinsically safe circuit to change a passive sensor signal (e.g. Pt 100) into an active mA/VDC signal.  <b>Delivery:</b> 1 Ex-i module for DIN rail mounting  <b>Accessory (optional):</b> modulating sensors type ExSens	<b>Basics EXL-IMU-1</b> <ul style="list-style-type: none"> <li>• Transducer for passive, potential free, modulating sensors series ExSens. 2-3-4-wire connection</li> <li>• 24 VAC/DC supply</li> <li>• Output: 0...10 VDC, 4...20 mA</li> <li>• Input: Pt 100/500/1000, Ni 100/200/500/1000, LS-Ni 1000 Siemens, KP 250, LF 20, DFK-..., VFK-..., passive sensors with resistance output 0...1.000 Ohm, 0...10.000 Ohm</li> <li>• Display for adjustment and actual value indication</li> <li>• Module must be installed in the safe area, sensor in the hazardous area</li> </ul>

### EXL-IMU-1 transducer

Type	Technical data	Installation module	Installation sensor*
EXL-IMU-1	1 module (rail mounting) for 1 passive sensor series ExSens	safe area	zone 0, 1, 2, 20, 21, 22
<b>Optional:</b>			
N1 supply unit	Input 120...240 VAC, output 24 VDC, max. 0,5 A, max. 4 pcs. EXL-IMU-1 connectable. N1 supply unit is required only in case of 120...240 VAC supply!		

\* in acc. with certification of sensor!

## ExSens passive modulating sensors for zone 1, 2, 22

Explosion proof		Features modulating ExSens	
<b>ExSens</b> Zone 1, 2, 22 Gas + Dust certified according ATEX Manufacturer certificate	<b>passive</b> 	<b>Description</b> ExSens sensors for temperature, humidity or pressure measurement in hazardous areas with manufacturer certification in acc. with ATEX 94/9/EC. The sensors are passive and potential free.  <b>Delivery:</b> 1 Sensor <b>Ordering example</b> for 1 room humidity sensor <b>Type to purchase:</b> 1 x FFR-2G	<b>Basics for ExSens sensors</b> <ul style="list-style-type: none"> <li>• Sensors for installation in hazardous areas, connected to a relevant transducer, e.g. ExCos-A, RedCos-A or EXL-IMU-1</li> <li>• The transducer changes the passive resistance signal into an active 0...10 VDC/4...20 mA signal</li> </ul>

### Sensors, connectable to ExCos-A, RedCos-A and EXL-IMU-1 transducer

Type	Function	Measuring range	Sensor	Connectable to transducers	Sensor in zone
TFR -2G	Room temperature	-30...+ 60 °C	Pt 100 DIN	EXL-IMU-1, ExCos-A, RedCos-A	1, 2
TFR -2G3D	Room temperature (IP65)	-40...+ 60 °C	Pt 100 DIN	EXL-IMU-1, ExCos-A, RedCos-A	1, 2, 22
TFK -2G3D	Duct temperature (IP65), 200 mm	-30...+150 °C	Pt 100 DIN	EXL-IMU-1, ExCos-A, RedCos-A	1, 2, 22
TFK -2G3D-400	Duct temperature, length 400 mm	-30...+150 °C	Pt 100 DIN	EXL-IMU-1, ExCos-A, RedCos-A	1, 2, 22
TFT -2G3D	Probe temperature (IP65), 100 mm	-30...+150 °C	Pt 100 DIN, tubing G½" Ms	EXL-IMU-1, ExCos-A, RedCos-A	1, 2, 22
TFT-V4A-2G3D	Probe temperature (IP65), 100 mm	-30...+150 °C	Pt 100 DIN, tubing G½" VA	EXL-IMU-1, ExCos-A, RedCos-A	1, 2, 22
TFM -2G-3	Mean value temperature 3 m	-20...+ 70 °C	Pt 100 DIN	EXL-IMU-1, ExCos-A, RedCos-A	1, 2
TFR-AN -2G3D	Room temperature direct contact	-30...+110 °C	Pt 100 DIN	EXL-IMU-1, ExCos-A, RedCos-A	1, 2, 22
FFR -2G	Room humidity	30...100 %rF	0...1 kΩ	EXL-IMU-1, ExCos-A, RedCos-A	1, 2
FFK -2G	Duct humidity	30...100 %rF	0...1 kΩ	EXL-IMU-1, ExCos-A, RedCos-A	1, 2
TFFR -2G	Room combination temp./humidity	30...100 %rF, -10...+60 °C	0...1 kΩ, Pt 100	2 x EXL-IMU-1, 2 x ExCos-A, 2 x RedCos-A	1, 2
TFFK -2G	Duct combination temp./humidity	30...100 %rF, -20...+60 °C	0...1 kΩ, Pt 100	2 x EXL-IMU-1, 2 x ExCos-A, 2 x RedCos-A	1, 2
DFK-07 -2G-FP	Differential pressure (IP65)	ΔP < 700 Pa	x...y Ω	EXL-IMU-1	1, 2
DFK-17 -2G-FP	Differential pressure (IP65)	ΔP < 1700 Pa	x...y Ω	EXL-IMU-1	1, 2
VFK-07 -2G-FP	Volume control (IP65)	0...15 m/s	x...y Ω	EXL-IMU-1	1, 2
SGR -2G	Potentiometer	Resistance	0...1 kΩ	EXL-IMU-1, ExCos-A, RedCos-A	1, 2
ExPro-AT-100	Duct temperature, length 100 mm	-40...+150 °C	Pt 100 DIN	EXL-IMU-1, ExCos-A, RedCos-A	1, 2, 21, 22
ExPro-AT-150	Duct temperature, length 150 mm	-40...+150 °C	Pt 100 DIN	EXL-IMU-1, ExCos-A, RedCos-A	1, 2, 21, 22
ExPro-AT-200	Duct temperature, length 200 mm	-40...+150 °C	Pt 100 DIN	EXL-IMU-1, ExCos-A, RedCos-A	1, 2, 21, 22

## Introducing ExBin – Binary sensor series for hazardous locations!

Differential pressure, temperature, humidity, fan belt monitoring and frost protection applications ...



HAZARDOUS LOCATIONS ZONE 1, 2, 21, 22

NO MODULE IN PANEL NEEDED

NO INTRINSIC SAFE CIRCUITS NEEDED

EASY INSTALLATION

EASY PARAMETERISATION

REDUCED INSTALLATION COST

ACTUAL VALUE INDICATION

C5-M OFFSHORE VERSION

STAINLESS STEEL SOLUTION



## ExBin../RedBin../InBin.. Binary Sensors – Overview

### Overview of the ExBin..., RedBin... and InBin... sensor technology

The binary sensors are subdivided in 3 installation- and 5 application areas.

**Installation areas:**

- ExBin- .....Sensors for Explosion proof zones 1, 2, 21, 22
- RedBin- .....Sensors for Explosion proof zones 2, 22
- InBin- .....Sensors for safe area (IP66)

**Application areas:**

- Ex/Red/InBin-P .....sensors for pressure and differential pressure monitoring
- Ex/Red/InBin-FR .....sensors for frost protection monitoring
- Ex/Red/InBin-N .....sensors for drive belt monitoring
- Ex/Red/InBin-D + ..Pro-B.....active probe sensors for temperature and/or humidity monitoring
- Ex/Red/InBin-A + ..Sens ..... passive probe sensors for temperature, humidity, pressure monitoring

**The binary sensor concept offers especially in Ex-area huge benefits:**

1. No intrinsically safe wiring required between the control panel and the sensor
2. No intrinsically safe circuit necessary inside the control panel
3. No switching module needed in the electrical control panel
4. Reduced installation cost
5. Easy installation
6. Easy parameterisation
7. 1- and 2-stage versions available
8. Actual value indication
9. Optional in stainless steel (AISI 316) or with C5-M painting

**Δ P** ExBin-P

Pressure, differential pressure (Filter/Fan belt monitoring) – binary, active

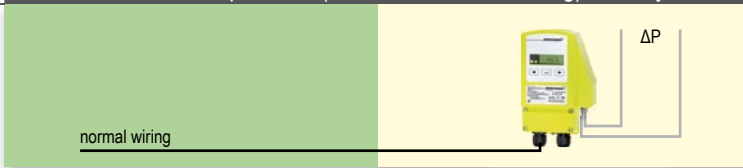

**ExBin-P., RedBin-P., InBin-P..**

Binary pressure/differential pressure auxiliary switch 0...5.000 Pa, for direct connection of air hoses. IP66 aluminium die-cast housing with integrated terminal box. Set points adjustable on site, output 1 potential-free make contact. Integrated indication of actual value, illuminated. 2-stage version optionally available.

**°C** ExBin-FR

Frost protection thermostats – binary, active

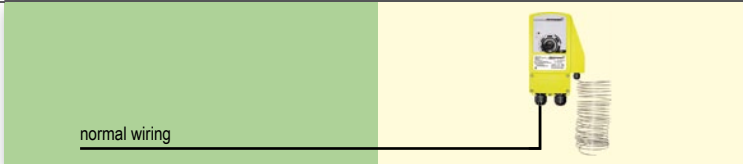

**ExBin-FR., RedBin-FR., InBin-FR..**

Frost protection thermostat mechanically adjustable and switching. Setting range -10...+15 °C. 3 or 6 m capillary as sensor with a resolution of 40 cm effective range. Switching status display with LED. IP66 Aluminium die-cast housing with integrated terminal box. Output 1 potential-free make contact.

**U<sub>min</sub>** ExBin-N

Drive belt monitoring via speed control – binary, active

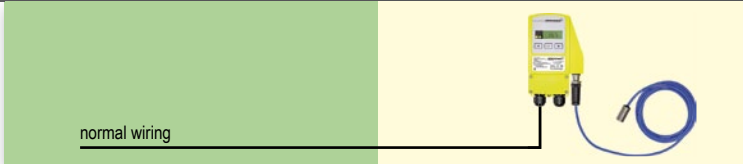

**ExBin-N., RedBin-N., InBin-N..**

Binary, contactless fan belt monitoring by inductive speed control. Measurement range 0...10.000 min<sup>-1</sup>, Setting range 50...10.000 min<sup>-1</sup>, incl. time switch relays and indication of actual value. IP66 Aluminium die-cast housing with integrated terminal box. Output 1 potential-free make contact. 2-stage version available optional.

**°C**  
**%rH** ExBin-D + ExPro-B..

Thermostats, hygrometers – binary, active

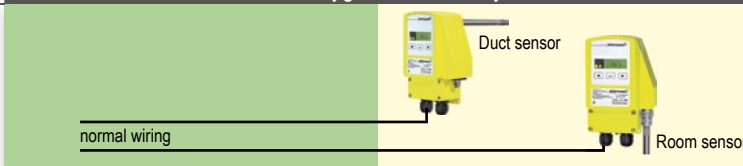

**ExBin-D., RedBin-D., InBin-D.. + ExPro-B.. respectively InPro-B... Sensor probes**

Thermostats and/or hygrometers for connection of one ExPro-B.. respectively InPro-B... sensor probe. Operating range adjustable. Indication of actual value. IP66 Aluminium die-cast housing with integrated terminal box. Output 1 potential-free make contact. 2-stage version optionally available.

**°C**  
**%rH**  
**Δ P** ExBin-A + ExSens

1-, 2- or 5-channel Ex-switching module for passive, binary sensors

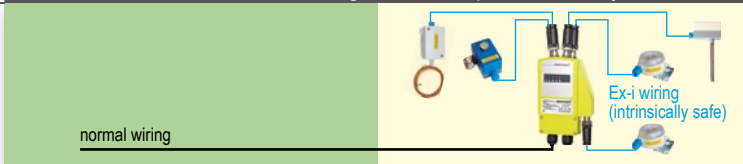

**ExBin-A1/A2/A5, RedBin-A1/A2/A5 + ExSens sensors binary**

1-, 2- or 5-channel Ex-switching module for connection of max. 5 passive, potential-free binary sensors. Switching status display with LED. IP66 Aluminium die-cast housing with integrated terminal box. Output depending on type 1-5 make contacts with collective supply unit.

**°C**  
**%rH**  
**Δ P** EXL-IRU-1 + ExSens

Temperature, humidity, differential pressure – binary, passive

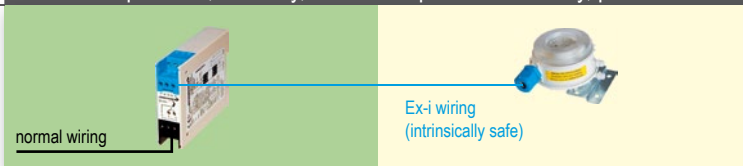



**EXL-IRU-1 switching module + ExSens sensor**

Ex-switching module for connection of one passive, binary ExSens sensor, such as differential pressure switch, frost protection thermostat or hygrometer through intrinsically safe electrical conduit. Installation in control box onto DIN-rail. Output is potential-free.

Safe area

Ex area

## ExBin-P/RedBin-P/InBin-P Pressure/differential pressure switch, binary

Explosion proof		Industrial	Features of ExBin-P, RedBin-P, InBin-P	
<b>ExBin-P...</b> Zone 1, 2, 21, 22 Gas + Dust certified according ATEX, IECEx, GOST-R, RTN, KOSHA 	<b>RedBin-P...</b> Zone 2, 22 Gas + Dust certified according ATEX, GOST-R, RTN, CSA 	<b>InBin-P...</b> NOT Explosion proof and only for use in safe area IP66 	<b>Description</b> ExBin-P, RedBin-P and InBin-P are pressure switches for HVAC systems, e.g. for differential pressure control for filter- or fan belt monitoring. ..Bin-P-100 pressure switch allows an achievement of new applications with a smaller differential pressure range. Additionally the ..Bin-P-100 has an adjustable switch activation delay contact for applications which require a time-delayed fault indication, for example short opening of doors in clean room environment. <b>Delivery:</b> 1 Pressure switch with integrated terminal box, 3 tapping screws	<b>Basics for all ...Bin-P sensors</b> <ul style="list-style-type: none"> <li>• No additional module in the panel required!</li> <li>• No intrinsically safe wiring required!</li> <li>• 24 VAC/DC supply</li> <li>• 1-channel: 1 potential-free contact</li> <li>• 2-channel (optional): 2 potential-free contacts</li> <li>• Switch-point is digitally adjustable</li> <li>• Indication of actual value (can be switched off)</li> <li>• Switching status display over LED</li> <li>• All parameters can be adjusted on site without additional tools and measurement devices</li> <li>• Aluminium housing IP66 with integrated terminal box</li> <li>• ..Bin-P-100 with switch activation delay, adjustable from 0...240 s</li> <li>• Dimensions (H × W × D) 180 × 107 × 66 mm</li> </ul>

### ExBin-P... Differential pressure switch for zone 1, 2, 21, 22

Type	Measurement range	Safe overload	Setting range	Special feature	Installation module
ExBin-P- 100	0... 100 Pa	up to 5.000 Pa	1-stage adjustable switch-point in meas. range	adjustable switch activation delay 0...240 s	zone 1, 2, 21, 22
ExBin-P- 500	0... 500 Pa	up to 5.000 Pa	1-stage adjustable switch-point in meas. range		zone 1, 2, 21, 22
ExBin-P- 500-2	0... 500 Pa	up to 5.000 Pa	2-stage adjustable switch-point in meas. range		zone 1, 2, 21, 22
ExBin-P-5000	0...5.000 Pa	up to 50.000 Pa	1-stage adjustable switch-point in meas. range		zone 1, 2, 21, 22
ExBin-P-5000-2	0...5.000 Pa	up to 50.000 Pa	2-stage adjustable switch-point in meas. range		zone 1, 2, 21, 22

### RedBin-P... Differential pressure switch for zone 2, 22

Type	Measurement range	Safe overload	Setting range	Special feature	Installation module
RedBin-P- 100	0... 100 Pa	up to 5.000 Pa	1-stage adjustable switch-point in meas. range	adjustable switch activation delay 0...240 s	zone 2, 22
RedBin-P- 500	0... 500 Pa	up to 5.000 Pa	1-stage adjustable switch-point in meas. range		zone 2, 22
RedBin-P- 500-2	0... 500 Pa	up to 5.000 Pa	2-stage adjustable switch-point in meas. range		zone 2, 22
RedBin-P-5000	0...5.000 Pa	up to 50.000 Pa	1-stage adjustable switch-point in meas. range		zone 2, 22
RedBin-P-5000-2	0...5.000 Pa	up to 50.000 Pa	2-stage adjustable switch-point in meas. range		zone 2, 22

### InBin-P... Differential pressure switch for safe area

Type	Measurement range	Safe overload	Setting range	Special feature	Installation module
InBin-P- 100	0... 100 Pa	up to 5.000 Pa	1-stage adjustable switch-point in meas. range	adjustable switch activation delay 0...240 s	safe area
InBin-P- 500	0... 500 Pa	up to 5.000 Pa	1-stage adjustable switch-point in meas. range		safe area
InBin-P- 500-2	0... 500 Pa	up to 5.000 Pa	2-stage adjustable switch-point in meas. range		safe area
InBin-P-5000	0...5.000 Pa	up to 50.000 Pa	1-stage adjustable switch-point in meas. range		safe area
InBin-P-5000-2	0...5.000 Pa	up to 50.000 Pa	2-stage adjustable switch-point in meas. range		safe area

### Accessories



Type	Technical data
Kit 2	Includes 2 meter pressure hose (inner diameter 6 mm) and 2 plastic fittings
MKR	Mounting bracket for installation on round air-ducts (diameter up to 600 mm)

Special options and offshore kits see page 52

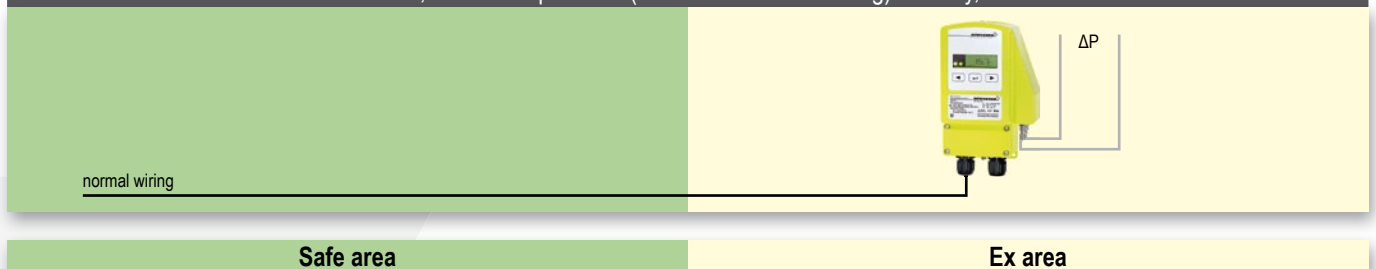
### Pressure, differential pressure (Filter/Fan belt monitoring) – binary, active



## ExBin-FR/RedBin-FR/InBin-FR Frost protection thermostats

Explosion proof		Industrial	Features ExBin-FR, RedBin-FR, InBin-FR	
<b>ExBin-FR...</b> Zone 1, 2, 21, 22 Gas + Dust certified according ATEX, IECEx, GOST-R, RTN 	<b>RedBin-FR...</b> Zone 2, 22 Gas + Dust certified according ATEX, GOST-R, RTN, CSA 	<b>InBin-FR...</b> NOT Explosion proof and only for use in safe area IP66 	<b>Description</b> ExBin-FR, RedBin-FR and InBin-FR are frost protection thermostats for HVAC systems, e.g. for frost protection monitoring of heating registers/heat exchangers.  <b>Delivery:</b> 1 Frost protection thermostat with integrated terminal box, with 3 m or 6 m capillary (depending on type), 3 tapping screws  <b>Recommended accessory:</b> for ..Bin-FR3: Kit 1.3 for ..Bin-FR6: Kit 1.6	<b>Basics for all ...Bin-FR sensors</b> <ul style="list-style-type: none"> <li>• No additional module in the panel required!</li> <li>• No intrinsically safe wiring required!</li> <li>• 24 VAC/DC supply</li> <li>• Temperature sensing by capillary with 3 m or 6 m length (depending on type)</li> <li>• Min. reaction length of capillary ~ 40 cm</li> <li>• 1 potential-free contact</li> <li>• Switch-point is mechanically adjustable</li> <li>• Switching status display with LED</li> <li>• Aluminium housing IP66 with integrated terminal box</li> <li>• Dimensions (H x W x D) 180 x 107 x 66 mm</li> </ul>

### ExBin-FR... frost protection thermostats for zone 1, 2, 21, 22

Type	Capillary	Temperature range	Setting range	Installation module
ExBin-FR-3	3 m	-10 ... +15 °C	1-stage adjustable switch-point in temperature range	zone 1, 2, 21, 22
ExBin-FR-6	6 m	-10 ... +15 °C	1-stage adjustable switch-point in temperature range	zone 1, 2, 21, 22

### RedBin-FR... frost protection thermostats for zone 2, 22

Type	Capillary	Temperature range	Setting range	Installation module
RedBin-FR-3	3 m	-10 ... +15 °C	1-stage adjustable switch-point in temperature range	zone 2, 22
RedBin-FR-6	6 m	-10 ... +15 °C	1-stage adjustable switch-point in temperature range	zone 2, 22

### InBin-FR... frost protection thermostats for safe area

Type	Capillary	Temperature range	Setting range	Installation module
InBin-FR-3	3 m	-10 ... +15 °C	1-stage adjustable switch-point in temperature range	safe area
InBin-FR-6	6 m	-10 ... +15 °C	1-stage adjustable switch-point in temperature range	safe area

### Accessories

Type	Technical data
Kit 1.3	Capillary duct, assembly clamp and 4 assembly brackets for frost protection thermostat ..Bin-FR-3
Kit 1.6	Capillary duct, assembly clamp and 8 assembly brackets for frost protection thermostat ..Bin-FR-6
MKR	Mounting bracket for installation on round air-ducts (diameter up to 600 mm)

Special options and offshore kits see page 52

### Frost protection thermostat – binary, active

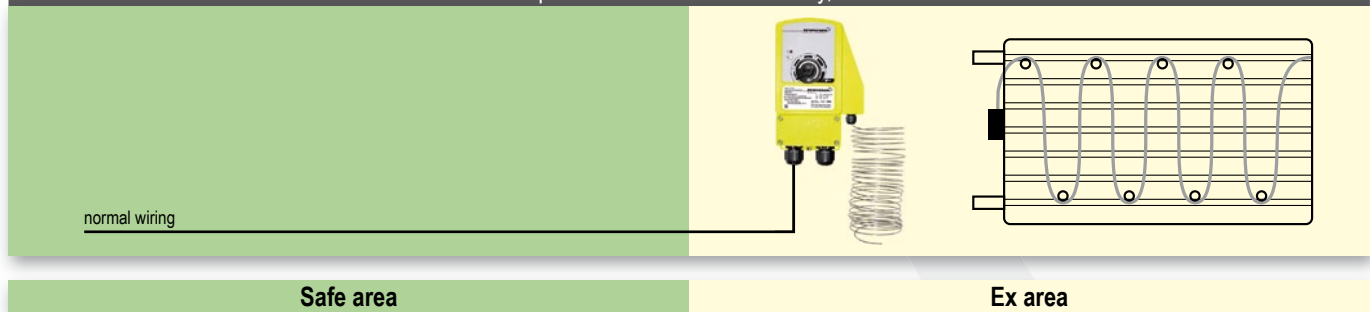

## ExBin-N/RedBin-N/InBin-N Fan belt monitoring via speed control

Explosion proof		Industrial	Features of ExBin-N, RedBin-N, InBin-N	
<b>ExBin-N...</b> Zone 1, 2, 21, 22 Gas + Dust certified according ATEX, IECEx, GOST-R, RTN	<b>RedBin-N...</b> Zone 2, 22 Gas + Dust certified according ATEX, GOST-R, RTN, CSA	<b>InBin-N...</b> NOT Explosion proof and only for use in safe area IP66	<b>Description</b> ExBin-N, RedBin-N and InBin-N are fan belt monitoring modules for HVAC systems, via speed control of fan drive shaft.  <b>Delivery:</b> 1 Fan belt monitoring modul with integrated terminal box and provided, directly mountable Namur transducer, 3 tapping screws  <b>Recommended accessory:</b> Dependend on air power and dimensions of ventilator/propeller a mounting console is required.	<b>Basics for all ...Bin-N sensors</b> <ul style="list-style-type: none"> <li>• No additional module in the panel required!</li> <li>• No intrinsically safe wiring required!</li> <li>• 24 VAC/DC supply</li> <li>• Measurement of number of revolutions in min<sup>-1</sup></li> <li>• Switch-point in min<sup>-1</sup> is digitally adjustable</li> <li>• Integrated, adjustable time switch relais</li> <li>• 1-channel: 1 potential-free contact</li> <li>• 2-channel (optional): 2 potential-free contacts</li> <li>• Display with indication of actual value</li> <li>• Switching status display with LED</li> <li>• Aluminium housing IP66 with integrated terminal box</li> <li>• Dimensions (H x W x D) 180 x 107 x 66 mm</li> <li>• Namur transducer included in delivery</li> </ul>

### ExBin-N.. fan belt monitoring modules via speed control for zone 1, 2, 21, 22

Type	Sensor	Speed control range	Setting range	Installation module
ExBin-N	Namur transducer, inductive, DIN 19234	0 ... 10.000 min <sup>-1</sup>	1-stage adjustable switch-point from 50...10.000 min <sup>-1</sup>	zone 1, 2, 21, 22
ExBin-N-2	Namur transducer, inductive, DIN 19234	0 ... 10.000 min <sup>-1</sup>	2-stage adjustable switch-point from 50...10.000 min <sup>-1</sup>	zone 1, 2, 21, 22

### RedBin-N.. fan belt monitoring modules via speed control for zone 2, 22

Type	Sensor	Speed control range	Setting range	Installation module
RedBin-N	Namur transducer, inductive, DIN 19234	0 ... 10.000 min <sup>-1</sup>	1-stage adjustable switch-point from 50...10.000 min <sup>-1</sup>	zone 2, 22
RedBin-N-2	Namur transducer, inductive, DIN 19234	0 ... 10.000 min <sup>-1</sup>	2-stage adjustable switch-point from 50...10.000 min <sup>-1</sup>	zone 2, 22

### InBin-N.. fan belt monitoring modules via speed control for safe area

Type	Sensor	Speed control range	Setting range	Installation module
InBin-N	Namur transducer, inductive, DIN 19234	0 ... 10.000 min <sup>-1</sup>	1-stage adjustable switch-point from 50...10.000 min <sup>-1</sup>	safe area
InBin-N-2	Namur transducer, inductive, DIN 19234	0 ... 10.000 min <sup>-1</sup>	2-stage adjustable switch-point from 50...10.000 min <sup>-1</sup>	safe area

### Accessories

Type	Technical data
Kit 3	Mounting set for Namur transducer onto ventilators/propellers <i>up to</i> approx. 20.000 m <sup>3</sup> /h
Kit 4	Mounting set for Namur transducer onto ventilators/propellers <i>over</i> approx. 20.000 m <sup>3</sup> /h
MKR	Mounting bracket for installation on round air-ducts (diameter up to 600 mm)

Special options and offshore kits see page 52

### Drive belt monitoring via speed control – binary, activ

normal wiring  <b>Safe area</b>	  <b>Ex area</b>
---------------------------------------	------------------------

## ExBin-D/RedBin-D/InBin-D Thermostats, hygrometers

Explosion proof		Industrial	Features of ExBin-D, RedBin-D, InBin-D	
<b>ExBin-D...</b> Zone 1, 2, 21, 22 Gas + Dust certified according ATEX, IECEx, GOST-R, RTN	<b>RedBin-D...</b> Zone 2, 22 Gas + Dust certified according ATEX, GOST-R, RTN, CSA	<b>InBin-D...</b> NOT Explosion proof and only for use in safe area IP66	<b>Description</b> ExBin-D, RedBin-D and InBin-D modules are used together with ExPro-B.../InPro-B... sensor probes as thermostats or hygrometers in HVAC systems.	<b>Basics for all ...Bin-D sensors</b> <ul style="list-style-type: none"> <li>• No additional module in the panel required!</li> <li>• No intrinsically safe wiring required!</li> <li>• 24 VAC/DC supply</li> <li>• Socket for ExPro-B... sensor</li> <li>• Selectable on site if used for room or duct application</li> <li>• Switch-point for °C and %rH separately adjustable (dependent on sensor probe type)</li> <li>• 1-channel: 2 pot.-free contacts (1 × °C, 1 × %rH)</li> <li>• 2-channel: 4 pot.-free contacts (2 × °C, 2 × %rH)</li> <li>• Display with indication of actual value</li> <li>• Switching status display with LED</li> <li>• Aluminium housing IP66 with integrated terminal box</li> <li>• Dimensions (H × W × D) 180 × 107 × 66 mm</li> </ul>
<b>Delivery:</b> 1 Ex/Red/InBin.. module with socket for 1 ExPro-B.../InPro-B... sensor, 3 tapping screws			<b>Required accessory (additional price):</b> ExPro-B... or InPro-B... sensor	
<b>Ordering example</b> for one thermostat in an air duct, 150 mm sensor length, with sensor in Ex zone 21.			<b>Types to order:</b> 1 × ExBin-D 1 × ExPro-BT150 (Ex-i sensor probe)	

### ExBin-D thermostats and/or hygrometers, depend on sensor probe type ExPro-B... for zone 1, 2, 21, 22

Type	Technical data	Installation module	Installation ExPro-B.. sensor
ExBin-D	Module for connection of one ExPro-B... sensor as thermostat and/or hygrometer, 1-stage	zone 1, 2, 21, 22	zone 1, 2, 21, 22
ExBin-D-2	Module for connection of one ExPro-B... sensor as thermostat and/or hygrometer, 2-stage	zone 1, 2, 21, 22	zone 1, 2, 21, 22

### RedBin-D thermostats and/or hygrometers, depend on sensor probe type ExPro-B... for zone 2, 22

Type	Technical data	Installation module	Installation ExPro-B.. sensor
RedBin-D	Module for connection of one ExPro-B... sensor as thermostat and/or hygrometer, 1-stage	zone 2, 22	zone 1, 2, 21, 22
RedBin-D-2	Module for connection of one ExPro-B... sensor as thermostat and/or hygrometer, 2-stage	zone 2, 22	zone 1, 2, 21, 22

### InBin-D thermostats and/or hygrometers, depend on sensor probe type InPro-B... for safe area

Type	Technical data	Installation module	Installation InPro-B.. sensor
InBin-D	Module for connection of one InPro-B... sensor as thermostat and/or hygrometer, 1-stage	safe area	safe area
InBin-D-2	Module for connection of one InPro-B... sensor as thermostat and/or hygrometer, 2-stage	safe area	safe area

### Accessories

Type	Technical data
MKR	Mounting bracket for installation on round air-ducts (diameter up to 600 mm)

Special options and offshore kits see page 52

### Example of combinations

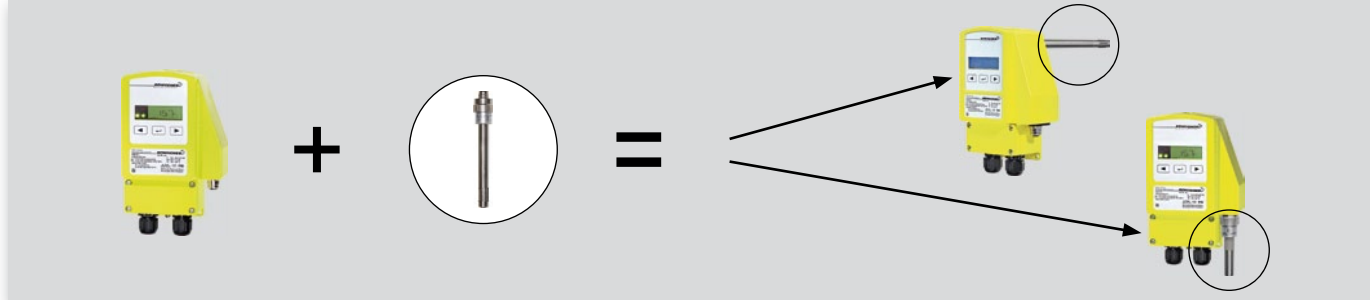



## ExPro-B/InPro-B Digital thermostat/hygrostat sensor probes

### Explosion proof

### Industrial

### Features of ExPro-B..., InPro-B..

#### ExPro-B...

Zone 1, 2, 21, 22  
Gas + Dust  
certified according  
ATEX, IECEx  
PTB-certified in acc.  
with ExBin-D/RedBin-D  
modules



#### InPro-B...

Only for use with  
InBin-D.. transducer!  
**NOT** for use in  
Ex area!



#### Description

ExPro-B... sensors are used for measurements of temperature and/or humidity in hazardous areas, for **exclusive** use with ExBin-D... / RedBin-D... modules!

InPro-B... sensors are suitable for temperature and/or humidity measurement in safe areas, for **exclusive** use with InBin-D... modules!

**Delivery:** 1 sensor with connector

**Example:** room-humidity sensor, 50 mm length

**Type:** 1 × ExPro-BF-50

**Attention:** only in combination with:  
1 × ExBin-D or RedBin-D  
(InBin-D... with InPro-B... sensors)

#### Basics for all ExPro-B.../InPro-B... sensors

- Sensors for connection to ExBin-D..., RedBin-D..., InBin-D... modules. Adaption via connector
- ExPro-B.../InPro-B... sensors can be optionally screwed to the housing at the back (duct measurement) or bottom (room measurement)
- When using humidity-sensors, the contamination and aggressiveness of the medium has to be regarded

### Sensor probes for ExBin-D and RedBin-D modules

Type	Function	Measurement range	Sensor length	Main use	Connectable to	Installation area
ExPro-BT - 50	Thermostat	-40...+ 80 °C	50 mm	Room/Duct	ExBin-D RedBin-D	zone 1, 2, 21, 22
ExPro-BT - 100	Thermostat	-40...+ 125 °C	100 mm	Duct	ExBin-D RedBin-D	zone 1, 2, 21, 22
ExPro-BT - 150	Thermostat	-40...+ 125 °C	150 mm	Duct	ExBin-D RedBin-D	zone 1, 2, 21, 22
ExPro-BT - 200	Thermostat	-40...+ 125 °C	200 mm	Duct	ExBin-D RedBin-D	zone 1, 2, 21, 22
ExPro-BF - 50	Hygrostat	0...100 %rH	50 mm	Room/Duct	ExBin-D RedBin-D	zone 1, 2, 21, 22
ExPro-BF - 100	Hygrostat	0...100 %rH	100 mm	Duct	ExBin-D RedBin-D	zone 1, 2, 21, 22
ExPro-BF - 150	Hygrostat	0...100 %rH	150 mm	Duct	ExBin-D RedBin-D	zone 1, 2, 21, 22
ExPro-BF - 200	Hygrostat	0...100 %rH	200 mm	Duct	ExBin-D RedBin-D	zone 1, 2, 21, 22
ExPro-BTF- 50	Combination Thermostat/Hygrostat	-40...+ 80 °C, 0...100 %rH	50 mm	Room/Duct	ExBin-D RedBin-D	zone 1, 2, 21, 22
ExPro-BTF-100	Combination Thermostat/Hygrostat	-40...+ 125 °C, 0...100 %rH	100 mm	Duct	ExBin-D RedBin-D	zone 1, 2, 21, 22
ExPro-BTF-150	Combination Thermostat/Hygrostat	-40...+ 125 °C, 0...100 %rH	150 mm	Duct	ExBin-D RedBin-D	zone 1, 2, 21, 22
ExPro-BTF-200	Combination Thermostat/Hygrostat	-40...+ 125 °C, 0...100 %rH	200 mm	Duct	ExBin-D RedBin-D	zone 1, 2, 21, 22

### Sensor probes for InBin-D modules

Type	Function	Measurement range	Sensor length	Main use	Connectable to	Installation area
InPro-BT - 50	Thermostat	-40...+ 80 °C	50 mm	Room/Duct	InBin-D	safe area
InPro-BT - 100	Thermostat	-40...+ 125 °C	100 mm	Duct	InBin-D	safe area
InPro-BT - 150	Thermostat	-40...+ 125 °C	150 mm	Duct	InBin-D	safe area
InPro-BT - 200	Thermostat	-40...+ 125 °C	200 mm	Duct	InBin-D	safe area
InPro-BF - 50	Hygrostat	0...100 %rH	50 mm	Room/Duct	InBin-D	safe area
InPro-BF - 100	Hygrostat	0...100 %rH	100 mm	Duct	InBin-D	safe area
InPro-BF - 150	Hygrostat	0...100 %rH	150 mm	Duct	InBin-D	safe area
InPro-BF - 200	Hygrostat	0...100 %rH	200 mm	Duct	InBin-D	safe area
InPro-BTF- 50	Combination Thermostat/Hygrostat	-40...+ 80 °C, 0...100 %rH	50 mm	Room/Duct	InBin-D	safe area
InPro-BTF-100	Combination Thermostat/Hygrostat	-40...+ 125 °C, 0...100 %rH	100 mm	Duct	InBin-D	safe area
InPro-BTF-150	Combination Thermostat/Hygrostat	-40...+ 125 °C, 0...100 %rH	150 mm	Duct	InBin-D	safe area
InPro-BTF-200	Combination Thermostat/Hygrostat	-40...+ 125 °C, 0...100 %rH	200 mm	Duct	InBin-D	safe area

### Accessories

Type	Technical data
MFK	Mounting flange for duct-installation, for variable depth of immersion in the air duct
TH- VA	Probe made of stainless-steel V4A 1.4571, length 150 mm for ..Pro-BT-200. Other lengths on request
Kit-FA-VA	Sinter filter cap for humidity sensor (only up to 90 %rH)
MKR	Mounting bracket for installation on round air-ducts (diameter up to 600 mm)

## ExBin-A/RedBin-A/InBin-A Switching modules

Explosion proof		Industrial	Features of ExBin-A, RedBin-A, InBin-A	
<b>ExBin-A</b> Zone 1, 2, 21, 22 Gas + Dust certified according ATEX, IECEx, GOST-R, RTN	<b>RedBin-A</b> Zone 2, 22 Gas + Dust certified according ATEX, GOST-R, RTN, CSA	<b>InBin-A</b> NOT Explosion proof and only for use in safe area IP66	<b>Description</b> ExBin-A, RedBin-A and InBin-A modules are switching modules for direct mounting in Ex areas (except InBin-A) with 1, 2 or 5 channels, for connection of 1, 2 or 5 passive potential-free binary sensors, for use in HVAC systems. <b>Delivery:</b> 1 module with sockets for 1 up to 5 ExSens sensors (dependent on type), 3 tapping screws <b>Accessory (optional):</b> Binary sensors series ExSens, see next page	<b>Basics for all ...Bin-A modules</b> <ul style="list-style-type: none"> <li>• No additional module in the panel required!</li> <li>• No intrinsically safe wiring required!</li> <li>• Mounting of module directly in Ex area</li> <li>• 24 VAC/DC supply</li> <li>• 1 up to 5 passive, potential-free, binary sensors</li> <li>• Sockets for 1 up to 5 ExSens sensors</li> <li>• 1 up to 5 contacts with common supply unit</li> <li>• 1 or 2 contacts with additional clamp for time switch relays, e.g. for 2 fan belt monitoring applications (time 120 sec.)</li> <li>• Display with indication of actual value</li> <li>• Switching status display with LED</li> <li>• Aluminium housing IP66 with integrated terminal box</li> <li>• Dimensions (H x W x D) 180 x 107 x 66 mm</li> </ul>

### ExBin-A.. Switching modules for 1 up to 5 passive binary sensors for zone 1, 2, 21, 22

Type	Technical data	Installation module	Installation sensor *
ExBin-A-1	Module (1 channel) to connect 1 binary ExSens sensor in Ex area	zone 1, 2, 21, 22	zone 0, 1, 2, 20, 21, 22
ExBin-A-2	Module (2 channel) to connect 2 binary ExSens sensors in Ex area	zone 1, 2, 21, 22	zone 0, 1, 2, 20, 21, 22
ExBin-A-5	Module (5 channel) to connect 5 binary ExSens sensors in Ex area	zone 1, 2, 21, 22	zone 0, 1, 2, 20, 21, 22

\* in acc. with certification of sensor!

### RedBin-A.. Switching modules for 1 up to 5 passive binary sensors for zone 2, 22

Type	Technical data	Installation module	Installation sensor *
RedBin-A-1	Module (1 channel) to connect 1 binary ExSens sensor in Ex area	zone 2, 22	zone 0, 1, 2, 20, 21, 22
RedBin-A-2	Module (2 channel) to connect 2 binary ExSens sensor in Ex area	zone 2, 22	zone 0, 1, 2, 20, 21, 22
RedBin-A-5	Module (5 channel) to connect 5 binary ExSens sensor in Ex area	zone 2, 22	zone 0, 1, 2, 20, 21, 22

\* in acc. with certification of sensor!

### InBin-A.. Switching modules for 1 up to 5 passive binary sensors for safe area

Type	Technical data	Installation module	Installation sensor
InBin-A-1	Module (1 channel) to connect 1 binary sensor	safe area	safe area
InBin-A-2	Module (2 channel) to connect 2 binary sensors	safe area	safe area
InBin-A-5	Module (5 channel) to connect 5 binary sensors	safe area	safe area

### Accessories

Type	Technical data
MKR	Mounting bracket for installation on round air-ducts (diameter up to 600 mm)

Special options and offshore kits see page 52

### 1, 2 or 5-channel switching module for passive binary sensors

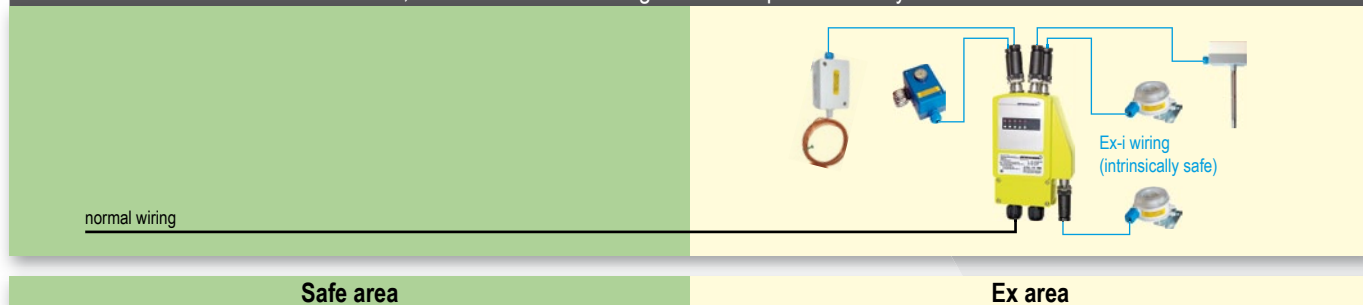

## ExLine Ex-switching module for potential free, binary signals in zone 0, 1, 2, 20, 21, 22

### Explosion proof

### Features EXL-IRU-1

EXL-IRU-1	EXL-IRU-1	Description	Basics EXL-IRU-1
Zone 0, 1, 2, 20, 21, 22 Gas + Dust certified according ATEX		EXL-IRU-1 module with intrinsically safe circuit to change a passive potential free binary signal (e.g. contact) into a contact in the safe area.  <b>Delivery:</b> 1 Ex-i module for DIN rail mounting  <b>Accessory (optional):</b> binary sensors type ExSens	<ul style="list-style-type: none"> <li>• 24 VAC/DC supply</li> <li>• Input: passive potential free binary sensor</li> <li>• Output: potential free contact in the safe area</li> <li>• Integrated time running relays 30...120 sec.</li> <li>• 2 LED to show switching position</li> <li>• DIN rail mounting</li> <li>• Module must be installed in the safe area, sensor in the hazardous area</li> </ul>

### EXL-IRU-1 switching module

Type	Technical data	Installation module	Installation sensor*
EXL-IRU-1	1 module (rail mounting) for 1 passive binary sensor series ExSens	safe area	zone 0, 1, 2, 20, 21, 22
<b>Optional:</b>			
<b>N1 supply unit</b>	Input 120...240 VAC, output 24 VDC, max. 0,5 A, max. 4 pcs. EXL-IRU-1 connectable. N1 supply unit is required only in case of 120...240 VAC supply!		

\* in acc. with certification of sensor!

## ExSens passive binary sensors for zone 1, 2, 22

### Explosion proof

### Features ExSens

ExSens	binary, passive	Description	Basics for binary ExSens sensors
Zone 1, 2, 22 Gas + Dust certified according ATEX Manufacturer certificate		ExSens binary sensors for temperature, humidity or pressure measurement in hazardous areas with manufacturer certification in acc. with ATEX 94/9/EC. The sensors are passive and potential free.  <b>Delivery:</b> 1 Sensor <b>Ordering example</b> for 1 frost protection thermostat <b>Type to purchase:</b> 1 × TBK-FR-2G	<ul style="list-style-type: none"> <li>• Sensors for installation in hazardous areas, connected to a switching module type ExBin-A, RedBin-A or EXL-IRU-1</li> <li>• The module changes the passive binary signal into a contact in the safe area</li> <li>• Sensor must be installed in the hazardous area, module in the safe area</li> </ul>

### Sensors, connectable to switching modules type ExBin-A, RedBin-A and EXL-IRU-1

Type	Function	Range	Sensor	Information	Connectable to module type	Sensor in zone
TBR -2G	Room thermostat	0...+40 °C, 1 K	Contact, 2-pos		EXL-IRU-1, ExBin-A, RedBin-A	1, 2
TBR -2G3D	Room thermostat (IP65)	-35...+30 °C, 2-20 K	Contact, 2-pos		EXL-IRU-1, ExBin-A, RedBin-A	1, 2, 22
TBR-2 -2G	Room thermostat 2 stage	0...+60 °C, 1 K	2 × Contact, 2-pos		2 × EXL-IRU-1, ExBin-A, RedBin-A	1, 2
TBR-AN-2G	Room temperature direct contact	0...+60 °C, 5 ± 1 K (fix)	Contact, 2-pos		EXL-IRU-1, ExBin-A, RedBin-A	1, 2
TBK -2G	Duct thermostat (IP65)	0...+65 °C, 2-20 K	Contact, 2-pos		EXL-IRU-1, ExBin-A, RedBin-A	1, 2
TBT -2G	Probe thermostat (IP54)	0...+90 °C, 3 K	Contact, 2-pos	L = 120 mm	EXL-IRU-1, ExBin-A, RedBin-A	1, 2
TBT-VA -2G	Probe thermostat with VA sleeve	0...+90 °C, 3 K	Contact, 2-pos	V4A	EXL-IRU-1, ExBin-A, RedBin-A	1, 2
TBK-FR-2G	Frost protection thermostat (IP65)	-10...+12 °C	Contact, 2-pos	capillary 6 m	EXL-IRU-1, ExBin-A, RedBin-A	1, 2
FBR -2G	Room hygrosat	35...100 %rH, ~ 4 %rH	Contact, 2-pos		EXL-IRU-1, ExBin-A, RedBin-A	1, 2
FBK -2G	Duct hygrosat	35...100 %rH, ~ 4 %rH	Contact, 2-pos	L = 180 mm	EXL-IRU-1, ExBin-A, RedBin-A	1, 2
DBK -2G	Differential pressure	20-300, 50-500, 100-1.000 Pa	Contact, 2-pos		EXL-IRU-1, ExBin-A, RedBin-A	1, 2
DBK -2G3D	Differential pressure (IP65)	40-125, 100-400, 350-1.400 Pa	Contact, 2-pos		EXL-IRU-1, ExBin-A, RedBin-A	1, 2, 22
WFBK -2G	Air paddle	2...8 m/s, paddle V2A	Contact, 2-pos		EXL-IRU-1, ExBin-A, RedBin-A	1, 2
SWBT -2G	liquid flow switch	-20...+60 °C	Contact, 2-pos		EXL-IRU-1, ExBin-A, RedBin-A	1, 2
NBW-K -2G	Fan belt protection (IP65)	up to < 20.000 m³/h	Namur sensor + bracket		EXL-IRU-1, ExBin-A, RedBin-A	1, 2
NBW-G -2G	Fan belt protection (IP65)	more than > 20.000 m³/h	Namur sensor + bracket		EXL-IRU-1, ExBin-A, RedBin-A	1, 2

### Accessories

Type	Technical data
Kit 1	for frost protection sensor type TBK-FR-2G, PG entries for capillary, 6 brackets, support bracket
Kit 2-DBK	includes 2 meter pressure hose (inner diameter Ø 6 mm) 2 plastic fittings

## ..VA/..CT Special options for sensors – overview

Overview of special options of Schischek sensors for use under extreme weather conditions

### Installation/Application area:

Usage in hazardous areas under extreme weather conditions and/or for offshore/onshore applications.

### Advantages of special options:

- Resistant against corrosive and/or maritime atmosphere
- Usage under extreme weather conditions
- Approved for offshore-/onshore applications
- Robust and thereby extended period of application time of sensors

Special options sensors		Sensors
<b>VA</b> <b>OVA</b> <b>CT</b> <b>OCT</b>	<b>Cos/Bin/Reg</b> 	Housing material in stainless steel (VA) or aluminium housing with C5-M painting (CT) for use under extreme weather conditions. OVA and OCT version for offshore applications.
	normal wiring	

## ..Cos/..Bin/..Reg Special options for sensors

### Explosion proof

### Features ..Cos/..Bin/..Reg-...-VA/OVA/CT/OCT

Cos/Bin/Reg-...-VA/CT	Special options	Description	Basics ..Cos/..Bin/..Reg-...-VA/OVA/CT/OCT
available for all sensors In accordance with type for use in Ex area or safe area		VA version with housing material in stainless steel similar AISI 316, some parts nickel plated. OVA version also with stainless steel housing but suitable especially for offshore applications. CT version with aluminium housing and C5-M painting, resistant against corrosive and maritime atmosphere, some parts nickel plated. OCT version with painted housing like CT, but suitable especially for offshore applications.  <b>Delivery:</b> 1 sensor with special option  <b>Ordering example:</b> ExCos-P-250-CT	<b>VA:</b> <ul style="list-style-type: none"> <li>• Housing material in stainless steel similar AISI 316, some parts nickel plated, resistant against corrosive / maritime atmosphere</li> </ul> <b>OVA:</b> <ul style="list-style-type: none"> <li>• Basics like VA, but offered as offshore version with additionally tubes for clamping ring Ø 6 mm in stainless steel</li> </ul> <b>CT:</b> <ul style="list-style-type: none"> <li>• C5-M painted aluminium housing, resistant against corrosive / maritime atmosphere</li> <li>• Cable glands brass nickel plated</li> <li>• Screws in stainless steel</li> </ul> <b>OCT:</b> <ul style="list-style-type: none"> <li>• Basics like CT, but offered as offshore version with M20 cable glands and additionally with tubes for clamping ring Ø 6 mm in stainless steel</li> </ul> <b>For general basics see sensor technology.</b>

## ..Cos/..Bin/..Reg-.. options

Type	Description/Technical data
Cos/Bin/Reg-...-VA*	Housing material in stainless steel similar AISI 316, some parts nickel plated (surcharge)
Cos-P/Bin-P/Reg-V-..OVA*	Offshore version with seawater resistant stainless steel housing. M20 cable glands nickel-plated, pressure connection tubes and screws in stainless steel (surcharge)
Cos/Bin/Reg-...-CT	C5-M painted aluminium housing, resistant against corrosive and/or maritime atmosphere. Cable glands nickel-plated, screws in stainless steel (surcharge)
Cos-P/Bin-P/Reg-V-..OCT	Offshore version with seawater resistant C5-M painted Al-housing. M20 cable glands nickel-plated, pressure connection tubes and screws in stainless steel (surcharge)
Kit-S8-	CBR Cable glands 2 × M16 × 1,5 mm Ex-e (for cables Ø 5-10 mm) in brass nickel plated for replace the plastic cable glands of ..Cos/..Bin/..Reg sensors
Kit-Offs-GL-CBR	Cable glands 2 × M20 × 1,5 mm Ex-d in brass nickel plated for armoured cables suitable for ..Cos/..Bin/..Reg sensors
Kit-PTC-	CBR Pressure tube connection in stainless steel 316 L for 6 mm clamp fittings

\*Available in second quarter.

## ExPolar Heating system – overview

Overview of new heating system for use with Schischek sensors down to -50 °C

### Installation/Application area:

Usage in hazardous areas for temperatures down to -50 °C.

### Advantages of ExPolar:

- Especially for usage under high sub-zero temperatures (down to -50°C)
- Suitable for applications with high temperature fluctuations (-50 °C up to +50 °C)
- Usage directly in hazardous locations
- Adaptable on all Schischek sensors

°C ExPolar...-CBR

Heating system for sensors

normal wiring

**ExPolar...-CBR**  
Adaptable on Schischek sensors type ExCos..., ExBin..., ExReg...

Safe area

Ex area

## ExPolar/InPolar Heating system for ..Cos../Bin../Reg.. sensors

Explosion proof	Industrial	Features ..Polar...-CBR	
<p><b>ExPolar...-CBR</b> Zone 1, 2, 21, 22 Gas + Dust certified according ATEX, IECEx</p>	<p><b>InPolar...-CBR</b> NOT explosion proof and only for use in safe area IP66</p>	<p><b>Description</b> Controlled heating system for use in sub-zero regions down to -50 °C or by high temperature fluctuations from -50 °C up to +50 °C. Adaptable on Schischek sensors ..Cos..., ..Bin... or ..Reg...</p> <p><b>Delivery:</b> 1 heating system (adaptable)</p> <p><b>Ordering example:</b> ExPolar-240-CBR</p>	<p><b>Basics ..Polar</b></p> <ul style="list-style-type: none"> <li>• 24/48 VAC/DC, 120/240 VAC</li> <li>• 40 W</li> <li>• -50 °C... +50 °C</li> <li>• ExPolar for zone 1, 2, 21, 22</li> <li>• InPolar for safe area</li> </ul>

### ExPolar...-CBR/InPolar...-CBR

Type	Adaptable on	Operation temperature	Supply				Power*	Installation area
ExPolar...-CBR	ExCos.../ExBin.../ExReg..	-50 °C up to +50 °C	24 VAC/DC	48 VAC/DC	120 VAC	240 VAC	40 W	zone 1, 2, 21, 22
InPolar...-CBR	InCos.../InBin.../InReg..	-50 °C up to +50 °C	24 VAC/DC	48 VAC/DC	120 VAC	240 VAC	40 W	safe area

↑ Supply voltage

\*Nominal value

VA option not considered!

### Special option

Type	Description/Technical data
...Polar...-CT	Housing C5-M painted, resistant against corrosive / maritime atmosphere, some parts nickel plated (surcharge)

## ExMag Electric doorholder magnets according ATEX for zone 1, 2, 21, 22

Explosion proof		Features ExMag	
<b>ExMag</b> Zone 1, 2, 21, 22 Gas + Dust certified according ATEX	<b>Magnet</b> 	<b>Description</b> ExMag doorholder magnets are electric magnets to keep doors open or closed as long as supply voltage is available.  <b>Delivery:</b> 1 magnet <b>Ordering example:</b> 650 N magnet + anchor + Ex-terminal box <b>Type to purchase:</b> 1 × EXM-650 + 1 GH 6 + 1 × EXC-K4/S	<b>Basics ExMag</b> <ul style="list-style-type: none"> <li>• Electric magnets, silicone free</li> <li>• Force in acc. with type</li> <li>• 24 VDC power supply</li> <li>• 1 m cable, silicone and halogen free</li> <li>• Ex-e terminal box is required for electrical connection</li> <li>• The max. AC-ripple must not exceed 20%</li> </ul>

### ExMag magnets

Type	Force	Supply	Function	Current	Installation in
EXM- 650	650 N	24 VDC	Magnet	44 mA	Zone 1, 2, 21, 22
EXM-1300	1.300 N	24 VDC	Magnet	65 mA	Zone 1, 2, 21, 22
EXM-2000	2.000 N	24 VDC	Magnet	160 mA	Zone 1, 2, 21, 22

### Accessories

Type	Technical data
GH-6	Anchor for EXM-650
GH-13/20	Anchor for EXM-1300 and EXM-2000
ExBox-3P	Ex-e terminal box, IP66
EXC-K4/S	Ex-e terminal box, IP66, with integrated fuse
EXC-T1	Ex-d push button
N1 supply unit	Input 120...240 VAC, output 24 VDC, max. 0,5 A

## ExComp different Ex-components

Explosion proof		Features ExComp	
<b>ExComp</b> Zone 1, 2, 21, 22 (in acc. to type) Gas + Dust certified according ATEX	<b>Components</b> 	<b>Description</b> Different explosion proof products like switches, safety temperature sensors, ....  <b>Delivery:</b> 1 component <b>Ordering example:</b> Switch 20 A, 6 pole <b>Type to purchase:</b> 1 × EXC-R 20/6	<b>Basics ExComp</b> <ul style="list-style-type: none"> <li>• No specific information</li> <li>• Data in acc. with every single product / type</li> </ul>

### ExComp components

Type	Application	Explosion proof	Technical data
EXC-R 10/3...	Switch	II2G EEx ed IIC T6	10 A - 240/400 V - 2,5/4,6 KW - 3 pole
EXC-R 20/3...	Switch	II2G EEx ed IIC T6	20 A - 240/400 V - 4,5/9,0 KW - 3 pole
EXC-R 20/6...	Switch	II2G EEx ed IIC T6	20 A - 240/400 V - 4,5/9,0 KW - 6 pole
EXC-R 40/3...	Switch	II2G EEx ed IIC T6	40 A - 240/400 V - 11/20 KW - 3 pole
EXC-R 40/6...	Switch	II2G EEx ed IIC T6	40 A - 240/400 V - 11/20 KW - 6 pole
EXC-R 80/3...	Switch	II2G EEx ed IIC T6	80 A - 240/400 V - 23/40 KW - 3 pole
EXC-R 80/6...	Switch	II2G EEx ed IIC T6	80 A - 240/400 V - 23/40 KW - 6 pole
EXC-RIA-16	Actual value indication	II2G EEx ia IIC T6	4...20 mA, loop powered
EXC-DS1/VA	Safety temperature sensor	II2G EEx d IIC T6	Duct mounting, potential free contact, switching at 70°C...160°C (10°C steps)

## Table of contents

<b>Additional information</b>		<b>Page</b>
Product codes/definitions		56-57
Installation according to ATEX (Zone system)		58
Installation according to NEC 500 (Division system, North America)		59
Valve automation		60-61
Certification information		62-63
Information about ATEX 94/9/EC		64
Labelling of explosion proof equipment according to ATEX		65
Explosion proof information		66
Information about zones, explosion groups and temperature classes		67
Ex applications		68
Notices		69
Rotork products		70-73
<b>NEW</b> Damper actuation focused		74-75

Product codes/definitions

Description ..Max quarter turn actuators

**Ex Max - 5.10 - SF**

- S = integrated auxiliary **switches**, switching at 5° and 85°
- F = **spring return** (german word for spring is "Feder")
- Y = **modulating** actuator 0...10 VDC or 4...20 mA and feedback signal
- BF = **fire damper actuator**, intrinsically safe input for direct ExPro-TT connection (fire trigger)
- F1/F3 = actuator with **fast spring return** (number after letter F shows closing time in seconds, e.g. in 1 or 3 seconds)
- C = **actuator for** direct communication with Ex/InReg **controller**

The numbers show the **torque in Nm**  
Two numbers mean that the **torque is selectable** on site (e.g. 5 or 10 Nm)

**Max** is a **rotary (quarter turn) actuator** for dampers or rotary valves, such as ball or butterfly valves

**Ex** is for use in **zone 1, 2, 21, 22**

**Red** is for use in **zone 2, 22**

**In** is for use in non classified **industrial** areas



Description ..Run valve actuators

**Red Run - 5.10 - Y**

- Y = **modulating** actuator 0...10 VDC or 4...20 mA and feedback signal
- U = **floating control** on/off, 3 pos. actuator with 0...10 VDC or 4...20 mA feedback signal

The numbers show the **force in N**  
Two numbers mean that the **force is selectable** on site (e.g. 500 or 1000 N)

**Run** is a **linear actuator** for globe style control valves with a stroke between 5 and 60 mm

**Ex** is for use in **zone 1, 2, 21, 22**

**Red** is for use in **zone 2, 22**

**In** is for use in non classified **industrial** areas



Description ..Cos modulating transducers

**In Cos - P - 2500**

The number shows the measuring range of the differential pressure sensor in **± Pa**

- P = **differential pressure** sensor
- D = module for **temperature/humidity** for connection of ExPro-C.. sensors
- A = transducer modul for connection of **passive** sensors

**Cos** modulating transducer with output 0...10 V or 4...20 mA

**Ex** is for use in **zone 1, 2, 21, 22**

**Red** is for use in **zone 2, 22**

**In** is for use in non classified **industrial** areas





Product codes / definitions

Description ..Bin binary sensors

**Ex Bin - P - 500 - 2**

The number stands for **2-stage adjustable switch-point** in measurement range  
Without number the sensor is 1-stage adjustable switch-point in measurement range

The number shows the max. adjustment range of the differential pressure switch in **Pa**

- P** = differential pressure switch
- D** = thermostat-/hygrostat modul for connection of ExPro-B.. sensors
- FR** = frost protection thermostat
- N** = fan belt monitoring via speed control
- A1** = switching module for connection of **one passive switch**
- A2** = switching module for connection of **two passive switches**
- A5** = switching module for connection of **five passive switches**

Bin switching measuring module with output as a potential free contact (1 opener or 1 closer)

**Ex** is for use in zone 1, 2, 21, 22  
**Red** is for use in zone 2, 22  
**In** is for use in non classified industrial areas



Description ..Pro.. sensors for ..Cos-D or ..Bin-D modules

**Ex Pro - CTF - 200**

The number shows the **length** of the sensor in **mm**

- T** = temperature sensor
- F** = humidity sensor
- TF** = combisensor temperature/humidity
- C** = sensor for connection to Ex/Red/InCos-D
- B** = sensor for connection to Ex/Red/InBin-D

Pro.. sensor for connection

**Ex** is for use in zone 1, 2, 21, 22  
**In** is for use in non classified industrial areas



Description ..Reg controller

**Ex Reg - V - 300 - A**

**A** = Type with **analog** signals for external communication  
**B** = Type with **bus** communication (RS485)

The number shows the control range of the controller in **Pa** (V-type only)

- V** = volume flow control/pressure control
- D** = temperature/humidity control

Reg controller

**Ex** is for use in zone 1, 2, 21, 22  
**In** is for use in non classified industrial areas



## Installation according to ATEX (Zone system)

### Installation zones

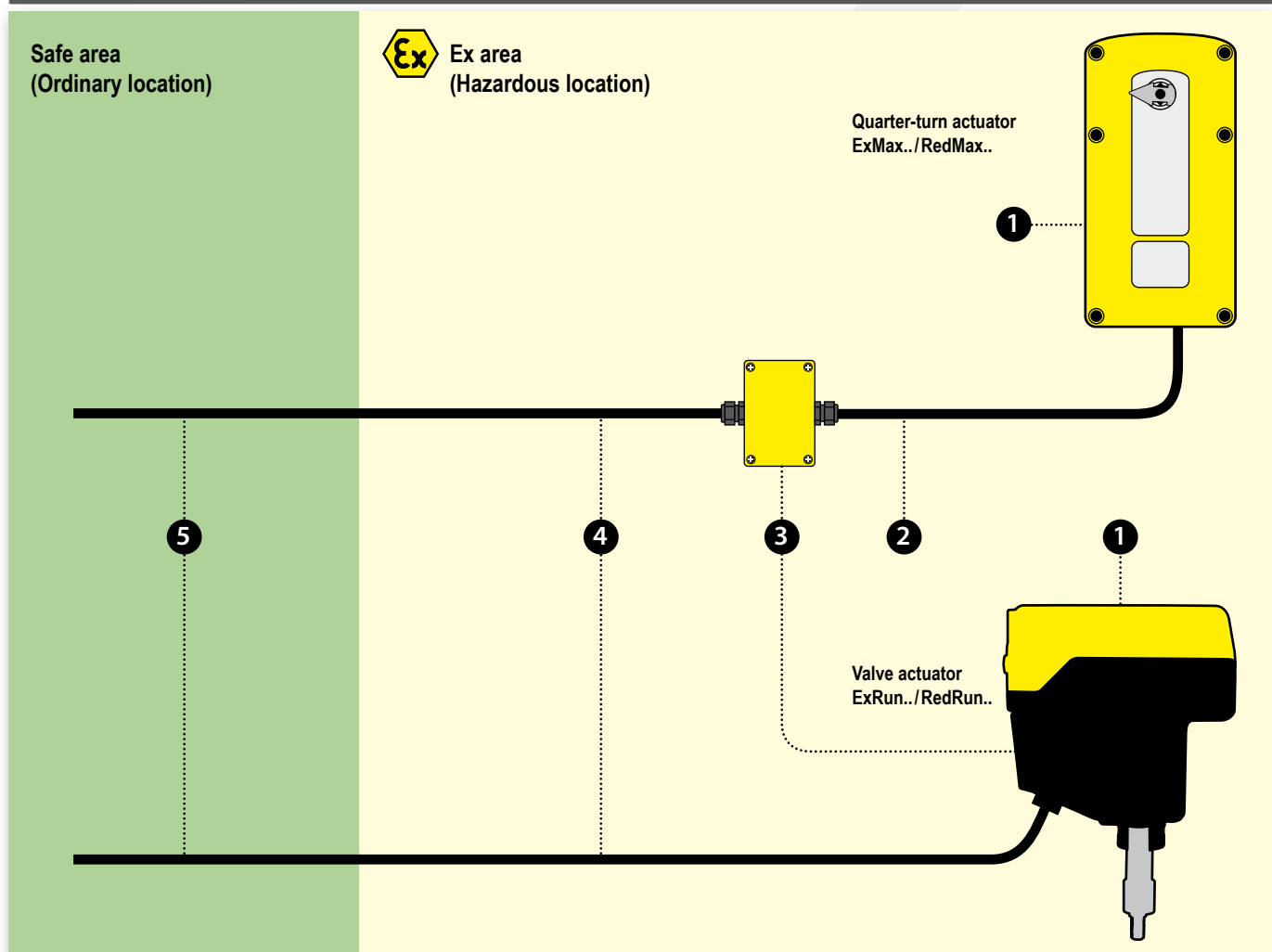

- ❶ Explosion proof actuator (ExMax/RedMax, ExRun/RedRun)
- ❷ Extension cable approximate ~ 1 m (39.4")
- ❸ Junction box in increased safety Ex-e technology

- ❹ Supply or control cable
- ❺ Supply or control cable reaches into the safe area...

Installation according to NEC 500 (Division system, North America)

Installation FM/CSA Div. classes

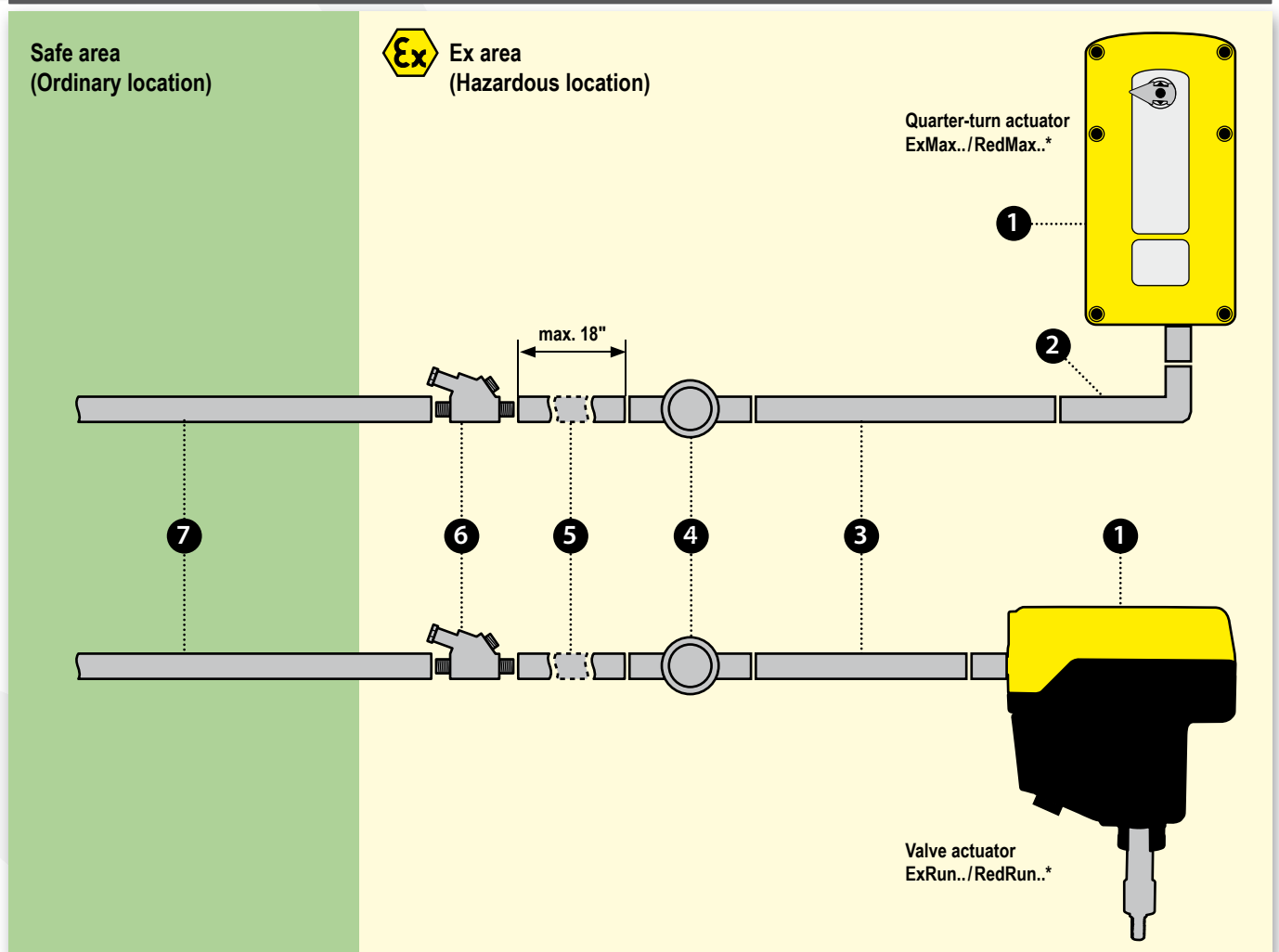

- ❶ Explosion proof actuator (ExMax/RedMax, ExRun/RedRun)
- ❷ Elbow device ...
- ❸ Connecting device ...
- ❹ Conduit box ...

- ❺ Connecting device, max. length 0,46 m (18")
- ❻ Seal fitting for horizontal or vertical conduits ...
- ❼ Connecting device reaches into the safe area ...

\* Variants for North America on request!

Valve automation

Quarter-turn actuators

**..Max**  
¼-turn actuator

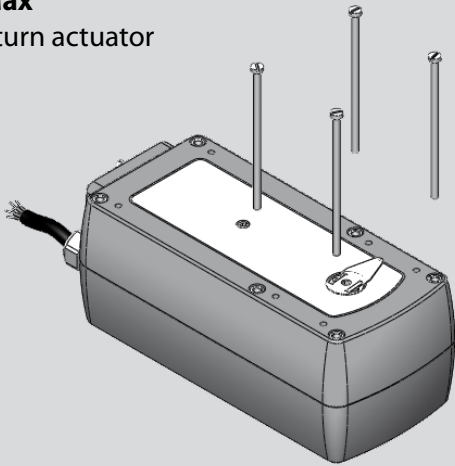

**Valve linkage**  
example

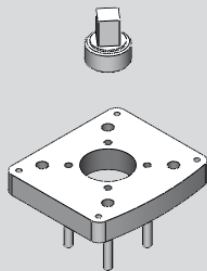

**Valve**  
example

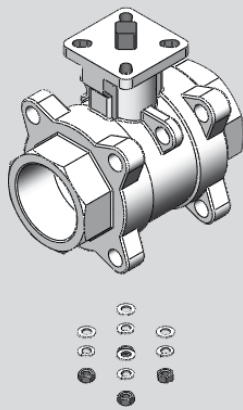

Linear motion actuators

**..Run**  
Linear valve actuator

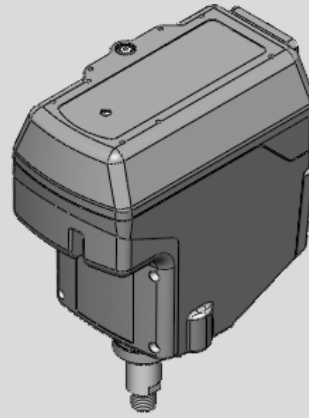

**Valve linkage**  
example

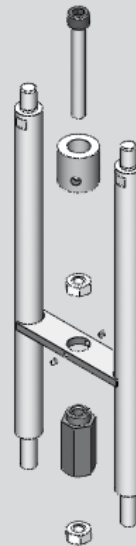

**Valve**  
example

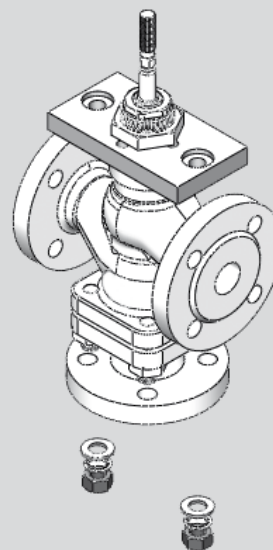

## Valve automation

### Schischek valve linkages

#### Option 1

You make the linkage yourself or source it somewhere else. In that case we would be happy to provide you with all the actuator dimensions necessary to do so. We can even give you STEP files you can import directly into your CAD system.

<b>SCHISCHEK</b> EXPLOSIONPROOF		Title <b>ExMax 5.10-Y / 15.30-Y</b> Dimensions	
List of parts	Project	Signed	
Substitute for	Actuator	Checked	
Origin	ExMax	Approved	
Schischek GmbH Mühlweg 45 Gewerbegebiet V D-90579 Langenreem		Drawing No. <b>090.0000.A4_Dimensions</b>	
Rev	Description	Date	Project No.
		Scale 1:2	Sheet 1 / 1

#### Option 2

Schischek designs and delivers the linkage

**Price:**

We can quote you a price for a linkage for any typical valve mounting pattern and stem (for example ISO 5211) without knowing the exact valve dimensions.

**Order:**

When you order the linkage however, we need the dimensions of the top plate/mounting pattern as well as the stem shape and dimensions to design the linkage. The cut sheet for your valve will typically have that information. Simply send us the cut sheet and we will do the rest.

- A -		- B -		- C -		- D -		- E -		- F -		- X -		- Y -		- Z -	
Square	Two flat	Fitting key	Flange type DIN 5211	Thread	Hole diameter	Height	Flange thickness	Distance	Torque	Nominal size	Material	Increment					
9	9	12	F03	M	mm	mm	mm	mm	Nm	DN	standard						
		14	F04	UNC	Zoll	Zoll	Zoll	Zoll	lb-in	Zoll	VA						
		18	F05	UNF	Zoll	Zoll	Zoll	Zoll	- U -	- V -	AISI 316						
		22	F07														
			F10														
			F12														
			Other														
			Other														

Customer	Country	Project
Actuator type	Armature	
	Type	Manufacturer

<b>SCHISCHEK</b> EXPLOSIONPROOF		Title <b>ExMax on ball valve</b>	
List of parts	Project	Signed	
Substitute for		Checked	
Origin		Approved	
Schischek GmbH Mühlweg 45 Gewerbegebiet Süd 5 D-90579 Langenreem		Drawing No. <b>2011.070.E0-USA</b>	
Rev	Description	Date	Project No.
		Scale 1:1.5	Sheet 1 / 1

## Certification with highest protection classes

ATEX • IECEx • IP66 • INMETRO • KOSHA • CSA • UL • GOST-R • RTN • TR CU



ATEX is a commonly used synonym for the ATEX directives of the European Union. The name is derived from the French term "ATmosphère EXplosible". The directive encompasses explosion protection directives 94/9/EG for equipment and 1999/92/EG for work areas. ATEX directives are devised by the Director General of the EU commission Enterprise and Industry in cooperation with the member states, standardization organizations (CEN, CENELEC) and so called "Notified Bodies" such as BAM, PTB, or TUEV to name examples from Germany.



IECEx is an internationally used process to certify electrical equipment used in hazardous locations. The code defines a system to classify locations with potentially explosive atmospheres caused by gases, dusts, or fibers for example. The main goal of the International Electrotechnical Commission IEC with the IECEx regulation is to reach global harmonization of codes governing use of electrical apparatus in hazardous locations. IEC promotes mutual acceptance of evaluations and reports among the testing labs and certifying bodies.



IP66 stands for Ingress Protection and denotes the protection of the device against environmental factors, dust and rain for example, as well as protection of living beings against dangers of touching high voltage circuits for example. The first digit categorizes ingress of solid objects, the second ingress of water:

- IP6x = dust proof
- IPx6 = water jet proof (with specifies water pressure etc.)



INMETRO (National Institute of Metrology, Quality and Technology) is Brazil's government body responsible for the implementation of measurement, safety and quality standards for electrical and electronic products. It guides the activities of accreditation, inspection, testing and certification bodies in the country.



KOSHA (Korea Occupational Safety and Health Agency) aims to contribute to the national economy by maintaining and improving the safety and health conditions at work through the efficient implementation of projects such as research and development, promotion of industrial accident prevention technologies, provision of technical assistance and training on occupational safety and health, inspection on dangerous facilities and equipment.

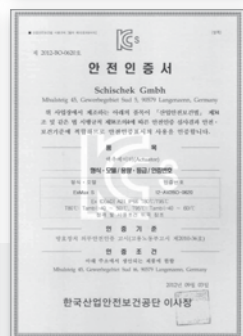

## Certification with highest protection classes

ATEX • IECEX • IP66 • INMETRO • KOSHA • CSA • UL • GOST-R • RTN • TR CU



CSA is a global provider of testing and certification services. CSA is also on the OSHA list of nationally recognized testing laboratories, NRTL.



UL is an independent organization that tests and certifies products with regards to safety. UL tests and evaluates compliance of products, components, materials, and systems against specific requirements. As a result the UL mark can be carried as long as the standards are complied with. UL is one of the OSHA endorsed testing labs. OSHA is the Occupational Safety and Health Administration and maintains a list of labs called NRTL, short for nationally recognized testing laboratories.

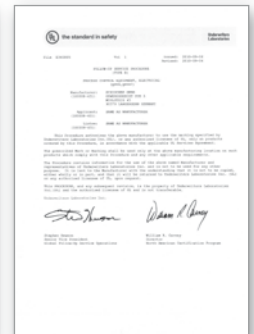

GOST-R denotes a certification obligatory for goods to be imported to the Russian Federation. Compliance has to be evaluated and approved based on Russian standards. GOST-R certification is required for examples for the following equipment:

- Food and food packaging equipment
- Electronic devices
- Industrial plants and machinery
- Products used in the oil & gas industry
- Electronic and technical systems



RTN is short for "RosTehNadzor". RTN certificates are required in Russia for industrial processes involving hazardous materials and conditions and are required for the equipment used. RTN approves the use of the equipment. RTN approvals are generally necessary for example:

- for all equipment used in the Oil & Gas industry
- all equipment requiring explosion protection



In the context of the Customs Union consisting of Russia, Belarus and Kazakhstan, new technical rules were continuously introduced since June 12, 2012 in order to create a common economic area. This also affects equipment intended for use in potentially explosive atmospheres. As part of this change, the GOST-R Explosion protection certificate was replaced by the new technical regulation TR CU 012/2011 "On the safety of equipment for use in potentially explosive atmospheres". Instead of the previously required GOST-R Ex certificate, it is now necessary to obtain a TR CU Ex certification. Likewise, the RTN approval process has been replaced by the TR CU regulations.

Certification in proceeding ...



## Information about electrical explosionproof according ATEX 94/9/EC

### Regulations for explosion protection

Explosion protection regulations in the EU member states are marked by the change of EU explosion protection directives 67/117/EWG, 76/177/EEC, 79/196/EEC and 82/130/EEC to the two new EU directives 94/9/EC (ATEX 95) and 1999/92/EG (ATEX 137). As a result of the new directives, explosion protection in European regulations are harmonized. The transition period to adjust from the "old" to the "new" European laws expired on June 30 2003.

Since July 1st 2003, electric explosion protected equipment must comply with ATEX Ex-protection directive 94/9/EC – on the approximation of the laws of the Member States concerning equipment and protective systems for use in potentially explosive atmospheres.

Information on the uniform classification of potentially explosive systems and its use this as a basis for selecting and classifying systems and equipment, incl. their installation, can be found in directive 1999/92/EC (ATEX 137).

#### ATEX

Directive 94/9/EC of the European Parliament and the European Council of March 23rd 1994 on the approximation of the laws concerning equipment and protective systems intended for use in potentially explosive atmospheres.

#### ExVO

Directive on the distribution of equipment and protection systems for potentially explosive areas – explosion protection prescription 11.GSGV.

#### Ordinance on Industrial Safety and Health

Ordinance concerning the protection of safety and health in the provision of work equipment and its use at work, concerning safety when operating installations subject to monitoring and concerning the organization of industrial safety and health at work.

#### Certificates

Corresponding approvals and certificates are required for electrical explosion protected equipment. Testing must be carried out by an official testing agency (Notified Body, for example the PTB, Physikalisch Technische Bundesanstalt in Braunschweig/Federal German Physical and Technical Institute in Braunschweig). ATEX approvals are also accepted in many countries and states outside Europe.

#### Responsibilities

The responsibility for compliance with all regulations and directives, from production and planning to installation, operation and maintenance, has greatly increased.

Each individual must be clear on the fact that he accepts personal responsibility as part of an overall project:

- building owners
- end-users
- architects

### The type plate and it's components

- consulting engineers/control companies
- inspection authorities
- contractors/installers
- manufacturers
- product suppliers
- maintenance engineers

#### The type plate and it's components

From 1/7/2003 the new ATEX guidelines come into force. The then current legal bases for the certification and labelling of electric explosion proof equipment is the EC guideline:

#### Example, for the labelling of a quarter turn actuator

Manufacturer's name, manufacturer's address, designation of type, electrical data (V, A, W, Hz) ambient temperature if different from -20 to +40°C, unit serial number, in addition to the classification of Ex protection.

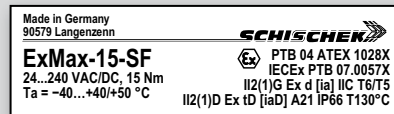

### Correct installation

For the installation of electrical systems in areas with explosive atmospheres of group II, standards IEC 60 079-14 (EN 60079-14) or VDE 0165 apply. In Germany however solely the Technical Rules for Occupational Safety grant the presumption of conformity!

#### Electric circuits of protection types d, e, q, o, m, p

Installation in the control panel is identical to "standard" installation, however the procedures for connecting Ex equipment must be followed. This relates, for example to voltage, current, fuses and motor protection equipment, etc. The requirements for specific products need to be taken from their corresponding test certificates, standards and regulations as well as from the user manual. It is only permitted to work on electric circuits within the Ex-area (for example when making connections in an Ex-e terminal box) when the voltage has been switched off. An Ex-e terminal box should only be opened after the voltage has been switched off.

#### Electric circuits of protection type "i" (intrinsic safety)

For the planning and operation of switchgears and control systems installed in the safe area, but which contain circuits leading into the Ex-area, certain requirements need to be considered. This applies especially to intrinsically safe circuits. Intrinsically safe circuits and non-intrinsically safe circuits need to be separated. Minimum distances (tight string length) between bare connections must be observed, the cables must not produce any inadmissible external inductance or capacitance. The maxi-

mum admissible electrical limits of Ex-i equipment must be observed at all times. Intrinsically safe and non-intrinsically safe electrical circuits may not be connected together. Connections between two different intrinsically-safe circuits are permitted on the condition that a calculation shows that intrinsic safety is not compromised.

Intrinsically-safe circuits have to be marked as such. When marking is done by means of colors, "light blue" color has to be used. This colour is recommended for all intrinsically safe circuits to prevent confusion and/or connection to a non-intrinsically safe circuit. Examples: cables, wiring, cable conduits, terminals, terminal boxes, cable glands ... A minimum distance of 50 mm between intrinsically safe and non-intrinsically safe circuits has to be maintained, and a minimum distance of 6 mm between two different intrinsically safe circuits. During installation the cables of intrinsically safe and non-intrinsically safe circuits are to be routed separately!

#### Suggestion on how to create a panel

It is necessary to keep intrinsically safe and non-intrinsically safe equipment separate. It is recommended, in this case, that a sufficient distance be kept, to avoid extra costs in the future.

Large transformers, frequency converters, large relays and other electric equipment that may influence intrinsically safe circuits by inductance or capacitance should be installed at a sufficient distance. As a precaution Ex-i equipment should have a suitable cover to protect it from incorrect handling. The appropriate standards and regulations must be observed.

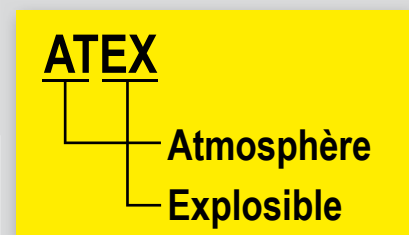



## Labelling of explosion proof equipment according to ATEX 94/9/EC

### Classification and labelling of hazardous locations

### Classification Explosion groups & Temperature classes

Flammable medium	Hazardous locations Probability of a potential explosive atmosphere occurring	Classification of hazardous locations	Product classification		Product level (EPL)	Explosion group	Examples depending on - explosion group - temperature class						
			Product group	Product category			Ammonia Methane Ethane Propane	Ethanol Cyclohexene n-Butane	Petrol Diesel fuel Fuel oil n-Hexane	Acetaldehyde			
Gases, mists, vapours	Always, temporarily or often present	Zone 0	II			IIA IIB IIC							
	Occasionally present	Zone 1	II	1G	Ga			City gas Acrylic nitrile	Ethylene Ethylene oxide	Ethyl glycol Carbon hydrogen	Ethyl ether		
	Very seldom or only present for a short period	Zone 2	II	2G	3G		Gb	Hydrogen	Acetylene				Carbon disulphide
Dusts	Always, temporarily or often present	Zone 20	II			T1 < 450 °C T2 < 300 °C T3 < 200 °C T4 < 135 °C T5 < 100 °C T6 < 85 °C							
	Occasionally present	Zone 21	II	1D	Da								
	Does not occur or only seldom for a short period	Zone 22	II	2D	3D		Db						

Official institutes	
code number	Institute Notified Body (NB)
0102	PTB (Germany)
0158	EXAM (Germany)

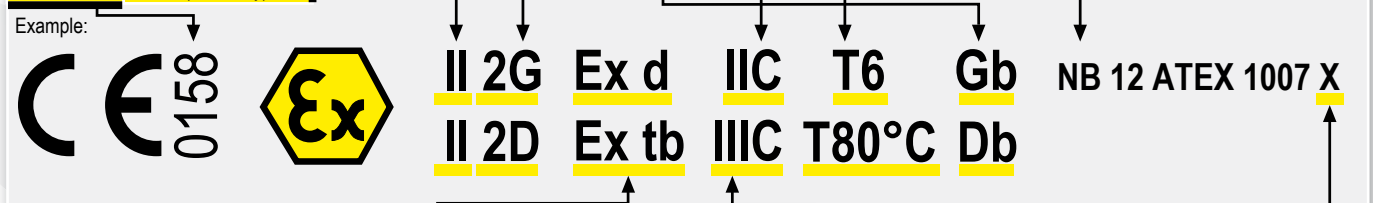

Prevents transmission of the explosion outside	flameproof enclosure	Ex d		1, 2	EN 60079-1
Prevents high temperatures and sparks	increased safety	Ex e		1, 2	EN 60079-7
Low current/voltage supply	intrinsic safety	Ex i <sup>1</sup> Ex iD <sup>2</sup>		0, 1, 2 20, 21, 22	EN 60079-11
Positive pressure device	pressurised apparatus	Ex p Ex pD		1, 2 21, 22	EN 60079-2
Encapsulated	moulding	Ex m <sup>3</sup> Ex mD <sup>4</sup>		0, 1, 2 20, 21, 22	EN 60079-18
Parts immersed in oil to isolate from explosive atmosphere	oil immersion	Ex o		1, 2	EN 60079-6
Prevents transmission of explosion outside	powder filling	Ex q		1, 2	EN 60079-5
As above, but for use in zone 2	protection "n"	Ex n		2	EN 60079-15
Dust explosion proof	protection "tD"	Ex t <sup>5</sup>		20, 21, 22	EN 60079-31
<b>Protection principle</b>	<b>Type of protection</b>	<b>Code</b>	<b>Symbol</b>	<b>To use in zone<sup>6</sup></b>	<b>CENELEC</b>

Code	Dust classification
IIIA	flammable fibres
IIB	non conductive dust
IIC	conductive dust

IP	Protection against solids/dust	Protection against water
8	-	long periods of immersion
7	-	the effects of temporary immersion
6	totally protected against dust	strong jets of water
5	dust - limited ingress	low pressure jets from all directions
4	solids objects > 1 mm	sprays from all directions
3	solids objects > 2,5 mm	direct sprays up to 60° from vertical
2	solids objects > 12,5 mm	direct sprays up to 15° from vertical
1	solids objects > 50 mm	vertical falling drops of water
0	no protection	no protection

Application	Code
For common use	-
For use under special circumstances	X
This product is an Ex-certified component for use in a complete system	U

Protection principle – Type of protection – EN 60079-0 General Requirements

Ingress Protection EN 60529

Further information

<sup>1</sup> ia (zone 0, 1, 2), ib (zone 1, 2), ic (zone 2)      <sup>3</sup> ma (zone 0, 1, 2), mb (zone 1, 2), mc (zone 2)      <sup>5</sup> ta (zone 20, 21, 22), tb (zone 21, 22), tc (zone 22)  
<sup>2</sup> iaD (zone 20, 21, 22), ibD (zone 21, 22), icD (zone 22)      <sup>4</sup> maD (zone 20, 21, 22), mbD (zone 21, 22), mcD (zone 22)      <sup>6</sup> Highest possible application areas



## Where and when do I have to take explosion proof into consideration ?

Explosion proof means: "Protection of Life. Health. Assets."

### When does the danger of an explosion occur?

A danger of explosion occurs when a flammable medium (gas, vapor, mist or dust) is present in a dangerous quantity.

### When does an explosion occur?

An explosion may occur when the following 3 components are present at the same time:

- Flammable or combustible media
- Oxygen
- Source of ignition

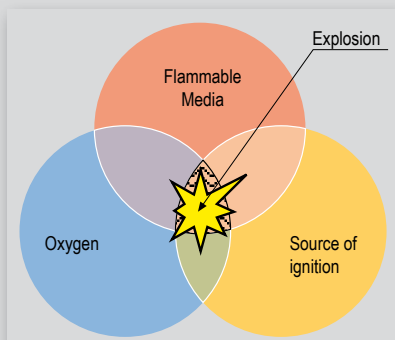

### Typical sources of ignition

Very often the cause of an accident is self-ignition, hot surfaces and mechanically generated sparks. But there are also a lot of other sources of ignition, caused by either mechanical and/or electrical equipment:

- Self-ignition
- Extraordinary surface temperatures
- Open flames
- Sparks caused by mechanical reasons
- Static electricity
- Lightning strike
- Ultra-sonic
- Chemical sources of ignition
- Electric sparks
- Electric arcs
- Adiabatic compression
- Adiabatic shock waves
- Electric balancing power

### Is your system safe ?

**We have the following situation NOW or in the FUTURE:**

Yes.No (Please check)

- Flammable materials are stored.
- Flammable materials are used.
- Flammable materials are bottled.
- Flammable materials are used during the cleaning process.
- Flammable materials are used in the production process.
- Flammable materials will be produced during the production process.

6 x "No": Obviously you do not need explosion proof

at least 1 x "YES":

When planning you have to consider rules, regulations and instructions concerning explosion proof

**Example: BetrSichV, ExVO, EX-RL**

### Remarks:

All information, tables, checklists and further documentation are only for your assistance and do not claim to be complete. In no way do they replace official regulations and rules or even laws by the authorities. We want to point out that it is very important to undertake all measures for an exact classification of the Ex-area.

### Typical Applications:

- Chemical, pharmaceutical and industrial plants
- Refineries, petrol depots, gas stations
- Paint and solvent shops
- Drying and coating cabinets
- Laboratories in industry and schools
- Water treatment works, power plants
- Compressor stations, gas works
- All kinds of storekeeping and stocks
- All kinds of filling stations
- All kinds of cleaning stations
- Mills, silos, silos for bulk goods
- Offshore and onshore
- Oil and gas pipelines
- Printing works, food industry, ...

### Schedule:

- Analyse whether you need explosion proof or not
- Ask experts in order to analyse the risk of danger
- Define zones, areas, categories, explosion groups and temperature classes
- Planning according to all necessary rules and regulations
- Choose the best supplier and the right product
- Keep to the installation rules
- Check the labelling of the equipment
- Make sure that the appliance will be put into operation correctly
- Confirm a final inspection by the responsible authority
- Guarantee regular and correct maintenance according to the regulations
- The correct documentation has to be maintained

### From combustion to detonation

Effect and reaction velocity increase significantly from combustion, deflagration, via explosion up to detonation. Explosions are more likely with gaseous media and detonations with dust media.

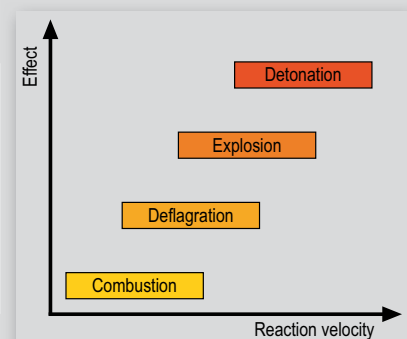

## Zones • Explosion groups • Temperature classes

### Implementation

Areas with potentially explosive atmospheres are divided into zones, equipment has to be divided into groups and categories. The labelling on the identification plate of certified equipment indicates in which zone the explosion protected equipment can be used.

#### Division into product groups

Equipment is divided into group I and group II. Group I consists of underground mines and group II deals with all other applications.

#### Division into zones

Areas with potentially explosive atmospheres are divided into six zones according to the probability of how frequent and for which period of time a potentially explosive atmosphere (p.e.a.) exists.

A distinction is made between combustible gases, mists, vapors and combustible dust. For gases, mists and vapors zones 0, 1 and 2 exist, in which the requirements for the chosen equipment increase from zone 2 to 0. Equipment in zone 0 must be built in a way "that even if a type of protection fails or if two faults occur, that sufficient explosion protection is guaranteed". Therefore for example a passive, potential free sensor, installed in zone 0, and connected to an intrinsically safe electric circuit (II 2 (1) G [Ex ia] IIC), needs its own approval. Zones 20, 21 and 22 are for dust atmospheres, in which the requirements for the chosen equipment increase from zone 22 to 20. Equipment in zone 20 and 21 need special approval.

#### Division into equipment groups

Equipment groups determine, in which zones the equipment may be installed. Once again there are six categories. Categories 1G, 2G and 3G are classifications for gas explosion protection (G = Gas); thereby 1G equipment is suitable for use in zones 0, 1 and 2, 2G equipment is suitable for use in zones 1 and 2 and 3G equipment is suitable for use in zone 2. Categories 1D, 2D and 3D are classifications for dust explosion protection (D = Dust); thereby 1D equipment is suitable for use in zones 20, 21 and 22, 2D equipment is suitable for use in zones 21 and 22 and 3D equipment is suitable for use in zone 2.

### Classification and labelling of hazardous locations

Flammable medium	Hazardous locations Probability of a potential explosive atmosphere occurring	Classification of hazardous locations	Product classification		Product level (EPL)
			Product Group	Product Category	
Gases Vapours Mists	Always, temporarily or often present	Zone 0	II	1G 2G 3G	Ga Gb Gc
	Occasionally present	Zone 1	II		
	Very seldom or only present for a short period	Zone 2	II		
Dusts	Always, temporarily or often present	Zone 20	II	1D 2D 3D	Da Db Dc
	Occasionally present	Zone 21	II		
	Does not occur or only seldom for a short period	Zone 22	II		

#### Zone 0, 1 and 2

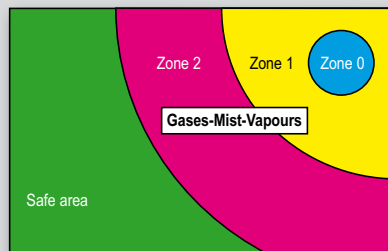

An Example of a typical zone activity would be filling a barrel of petrol in an enclosed area.

#### Zone 20, 21 and 22

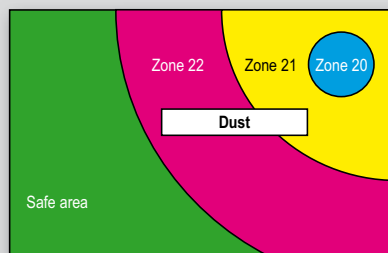

An example of a typical zone activity would be filling a grain silo in an enclosed area.

#### Explosion groups, temperature classes

The equipment groups and categories determine, in which zones the equipment may be installed, whereas the explosion groups and temperature classes determine, for which mediums inside the zones, the equipment is suitable. The type of protection used is not a mark of quality but is instead a constructive solution for selecting equipment for explosion protection.

#### Division into explosion groups

Explosion protected equipment for gases, mists and vapors is divided into three explosion groups (IIA-IIIC) according to the type of protection being used. The explosion group is a means to measure the ignitability of gases (potentially explosive atmospheres). The equipment requirements increase from IIA to IIC.

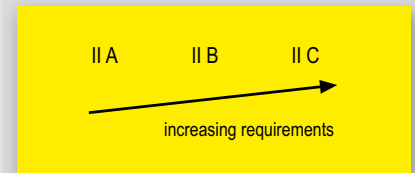

#### Division into temperature classes

Explosion proof equipment, installed within an Ex area, is divided into 6 temperature classes (T1 to T6). The temperature class is not – as it is often wrongly believed – the operating temperature range of the equipment, but the maximum permissible surface temperature of the equipment, in relation to +40°C ambient temperature on any surface area, which may not be exceeded at any time. The maximum surface temperature must remain below the ignition temperature of the surrounding medium at all times. The equipment design requirements increase from T1 to T6.

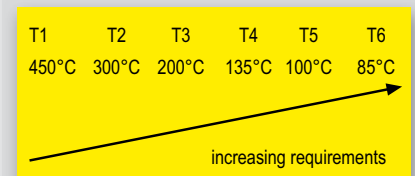

## Ex applications

### Air safety dampers • Air control dampers • Fire/smoke dampers

#### Air damper control

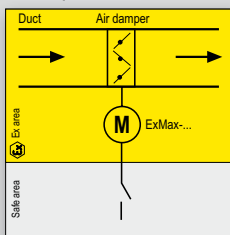

Schischek actuators are approved for direct installation and operation in explosive atmospheres, as they are of the highest explosion groups and temperature class and are suitable for all gases, mists, vapors and dust. During installation please ensure that all cables are securely fixed and connected in such a way that they are protected from mechanical damage. For electrical connection an explosion protected terminal box (type ExBox-...) has to be used.

#### Automatic air damper control

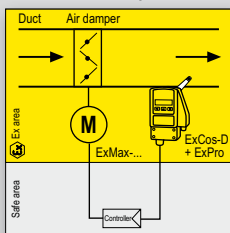

In this example the control system consists of an actuator and an ExCos-D transducer with ExPro sensor. The combination can be installed directly in an Ex area. The transducer converts the sensor signal into an active signal (0...10 VDC or 4...20 mA) for input in a PLC system. The output signal from the controller goes directly to the actuator. Between sensor and controller an additional Ex-i module and intrinsically safe (IS) circuit wiring are not required. For the actuator and transducer the maximum permissible surface temperatures have to be taken into account.

#### Control of fire/smoke dampers

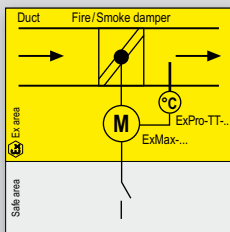

In applications for fire/smoke dampers, the actuator has to reliably return the damper to its safety position via an external switch/contact. The actuator closes the damper mechanically by means of an internal spring. The closing operation is triggered by a safety thermal trigger of type ExPro-TT...

### Heating • Cooling • Humidification • Diff.pressure control • VAV

#### Heating/cooling control

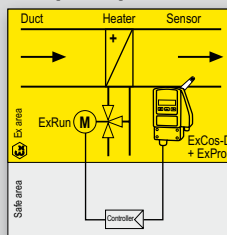

In this example the control system consists of an actuator and an ExCos-D transducer with ExPro sensor. The combination can be installed directly into an Ex area. The transducer converts the sensor signal into an active signal (0...10 VDC or 4...20 mA) for input in a PLC system. The output signal from the controller goes directly to the actuator. Between sensor and controller an additional Ex-i module and intrinsically safe (IS) circuit wiring are not required. For the actuator and transducer the maximum permissible surface temperatures have to be taken into account.

#### Humidity control

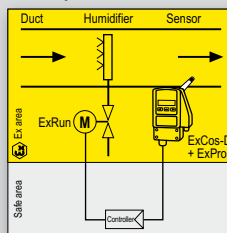

In this example the control system consists of a valve actuator and an ExCos-D transducer with ExPro sensor. The combination can be installed directly into an Ex area. The transducer converts the sensor signal into an active signal (0...10 VDC or 4...20 mA) for input in a PLC system. The output signal from the controller goes directly to the actuator. Between sensor and controller an additional Ex-i module and intrinsically safe (IS) circuit wiring are not required. For the actuator and transducer the maximum permissible surface temperatures have to be taken into account.

#### Differential pressure control/VAV

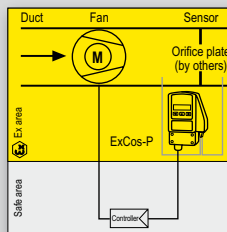

In this example the control system consists of an actuator and a differential pressure ExCos-P transducer. The combination can be installed directly in an Ex area. The transducer converts the differential pressure signal into an active signal (0...10 VDC or 4...20 mA) for input in a PLC system. The output signal from the controller goes directly to the actuator. Between sensor and controller an additional Ex-i module and intrinsically safe (IS) circuit wiring are not required. The controller is located in the safe area and delivers an output signal for example via a frequency converter to control a fan (must be Ex protected) or a modulating damper actuator (also Ex protected) to maintain the required air volume/pressure. The technical specifications can be found in the approval documents.

### Thermostats • Humidistats • Pressostats • Filter monitoring

#### Thermostats

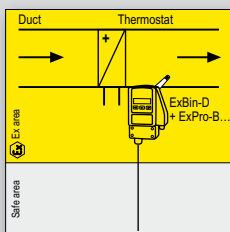

ExBin-D... modules with ExPro-BT... sensor are thermostats for use in potentially explosive atmospheres. No intrinsically-safe electrical circuits and no switching amplifiers need to be installed in the electrical control-panel. The module may be installed directly in an Ex area, depending on demand in zone 1, 2, 21 or 22. The output contact can be used for follow-up functions (relays, contacts, direct circuit, ...).

#### Hygrostats

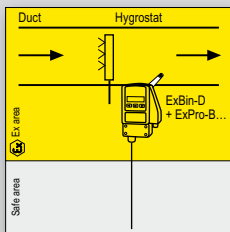

ExBin-D... modules with ExPro-BF... sensor are hygrostats for use in potentially explosive atmospheres. No intrinsically-safe electrical circuits and no switching amplifiers need to be installed in the electrical control-panel. The module may be installed directly in an Ex area, depending on demand in zone 1, 2, 21 or 22. The output contact can be used for follow-up functions (relays, contacts, direct circuit, ...).

#### Filter monitoring

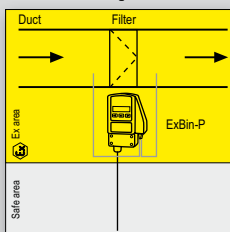

ExBin-P... modules are pressostats like Ex-differential pressure switches, e.g. for filter monitoring in potentially explosive atmospheres. No intrinsically-safe electrical circuits and no switching amplifiers need to be installed in the electrical control-panel. The module may be installed directly in an Ex area, depending on demand in zone 1, 2, 21 or 22. The output contact can be used for follow-up functions (relays, contacts, direct circuit, ...).

### Drive (Fan) belt monitoring • Frost protection

#### Drive (Fan) belt monitoring with differential pressure sensor/air paddle

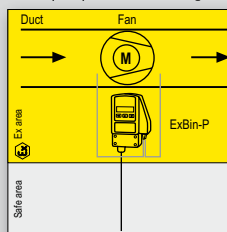

ExBin-P... modules are pressostats like Ex-differential pressure switches, e.g. for fan belt monitoring in potentially explosive atmospheres. No intrinsically-safe electrical circuits and no switching amplifiers need to be installed in the electrical control-panel. The module may be installed directly in an Ex area, depending on demand in zone 1, 2, 21 or 22. To indicate fan failure switching modules are delivered with integrated time running relay with delay on start up. The output contact can be used for follow-up functions (relays, contacts, direct circuit, ...).

#### Drive (Fan) belt monitoring with inductive sensor

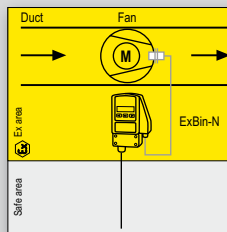

ExBin-N... modules with connected Namur sensor (inductive proximity switch) are especially for contact-free fan belt monitoring of ventilators, for use in potentially explosive atmospheres. No intrinsically-safe electrical circuits and no switching amplifiers need to be installed in the electrical control-panel. The module may be installed directly in an Ex area, depending on demand in zone 1, 2, 21 or 22. To indicate fan failure switching modules are delivered with integrated time running relay with delay on start up. The output contact can be used for follow-up functions (relays, contacts, direct circuit, ...).

#### Frost protection

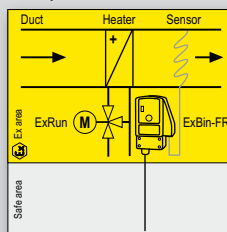

ExBin-FR... are sensors for frost protection monitoring with a capillary as measuring element for use in potentially explosive atmospheres. No intrinsically-safe electrical circuits and no switching amplifiers need to be installed in the electrical control-panel. The module may be installed directly in an Ex area, depending on demand in zone 1, 2, 21 or 22. The output contact can be used for follow-up functions (relays, contacts, direct circuit, ...).



## Introduction

# rotork

<sup>®</sup>

For over fifty years, engineers have relied upon Rotork for the most innovative and dependable valve actuation and flow control solutions. From safety systems that may be needed just once in a lifetime to high precision controls that are constantly on the move, Rotork products remain the clear choice, worldwide.

### Leaders in Flow Control

From its inception over 50 years ago, Rotork has grown to be a major international business with subsidiaries all around the world.

We are recognised as global leaders, designing and building the most reliable products, backed up by highly acclaimed customer service.

A genuine, long-term commitment to customers and partners underpins our culture of engineering excellence, making Rotork a consistently dependable choice for products and service.

### Committed to Innovation

Throughout the company's history, our engineers have focused on solving customer challenges and developing new solutions with levels of engineering skill and creativity that our competitors still cannot match.

Some innovations are adopted almost immediately, whilst others may require thousands of hours of testing and certification before they can be offered to our customers.

With every product that Rotork develops, you can be sure of one thing: That quality and reliability are an integral part.

### Serving the World

Rotork has always been committed to a global customer-base, supporting operations in some of the most remote and challenging environments.

We have established manufacturing facilities across the globe plus over 350 offices and regional centres of excellence. These provide our staff with all the training and support they need to deliver excellent service, wherever they are needed.

Whether you work directly with Rotork or engage through a partner, you can be confident that our products and support remain the best in the world.



## Electric Control Valve Actuators (Extraction)

### Linear and rotary actuators

#### CVA range



- Linear: Thrust range 890 to 22,241 N (200 to 5,000 lbf)
- Rotary: Torque range 54.2 to 271 Nm (480 to 2,400 lbf.in)
- High performance, continuous unrestricted modulating duty - S9
- High resolution and repeatability
- Pakscan, HART®, Profibus®, Modbus and Foundation Fieldbus® available. Optional hard wired RIRO (Remote In Remote Out)
- Comprehensive data logging
- Watertight IP68 and explosionproof enclosures
- Programmable fail-to-position option
- Temp. range -30 to 70 °C (-22 to 158 °F) + Low Option
- 'Intrinsically Safe' control & instrumentation. Non-intrusive setup/calibration using *Bluetooth*® wireless technology
- Optional manual override

### Linear, quarter-turn and rotary actuators

#### CMA range



The Rotork CMA is suitable for almost all linear, quarter-turn and rotary control valve and pump applications requiring exact position control and unrestricted continuous modulation.

- Linear: Thrust range 178 to 3,336 N (40 to 750 lbf)
- Rotary/QT: Torque range 2.3 to 113 Nm (20 to 1,000 lbf.in)
- Permanently lubricated and maintenance free drive train
- Accurate and repeatable position control
- Pakscan, HART, Profibus, Modbus and Foundation Fieldbus available. Optional hard wired RIRO (Remote In Remote Out)
- Temp. range -30 to 70 °C (-22 to 158 °F) + Low Option
- Electronic thrust/torque limiting
- Manual override standard

### IQ – multi-turn actuators

#### IQ range



Intelligent communication options and multilingual display. The IQ offers multi- and quarter-turn isolating/regulating duty.

- Torque range:  
Multi-turn direct drive 14 to 3,000 Nm (10 to 2,200 lbf.ft)  
Multi-turn with IS or IB gearbox, up to 40,800 Nm (30,000 lbf.ft)  
Quarter-turn with IW gearbox up to 250,000 Nm (185,000 lbf.ft)
- Complete integrated motor control
- Infra-red or *Bluetooth*® wireless technology for simple set-up and adjustment
- Digital, analogue or bus system remote control and status reporting
- Comprehensive software tools for plant records and valve performance analysis

### ROM – compact and lightweight design

#### ROM range



Building on the simple specification of the ROM/RBM range, Rotork now offer a more complete control solution with the introduction of the new ROMpak.

ROMpak introduces: Local controls for ease of operation; Dual local indicators – mechanical and LED; Phase rotation correction for ease of installation. Options include: *Bluetooth* non-intrusive configuration, bus communication, Folomatic/CPT and datalogger.

- Torque range 35 to 650 Nm (25 to 480 lbf.ft)
- Efficient yet simple gearing
- Wide range of supply voltages available
- Single-phase, three-phase and DC options
- Watertight IP67 rating

## Fluid Power Actuators (Extraction)

### Vane actuators

## K-TORK range



- Pneumatic actuators in double-acting and spring-return configurations
- Compact no-sideload, constant-torque design with output to 16,950 Nm (150,000 lbf.in)
- Complies with EN60529 (1991) + (A1:2000) for IP67M
- Complies with ANSI/AWWA C540-02 and C541-08
- Conforms to VDI/VDE 3485 control accessory mounting standards
- Modulating accuracy of 0.25 % or better

### Compact scotch yoke actuators

## RC200 RCI200 ranges



- Extremely compact scotch yoke pneumatic actuator
- Double-acting and spring-return configurations
- Contained spring module for safety and convenience
- Torque output to 4,400 Nm (38,000 lbf.in)
- Valve mounting dimensions per ISO 5211/DIN 3337
- Compatible with SVM partial stroke testing
- Certified suitable for use at SIL3 as a single device in accordance with IEC 61508
- Actuators certified in accordance with PED 97/23/EC
- Actuators certified to ATEX 94/9/EC

### Pneumatic rack and pinion actuator

## GT range



- Pneumatic rack and pinion actuator
- Double-acting and spring-return configurations
- Constant torque range from 3 to 15880 Nm
- Valve interface according ISO 5211/DIN 3337
- Solenoid valve interface according NAMUR VDI/VDE 3845
- Feedback/accessory interface according NAMUR VDI/VDE 3845
- Standard certifications: ATEX, CE, SIL3, GOST, RTN
- Options: epoxy-coating, hardanodizing, electric nickel plating, stainless steel pinion, speed regulation (other possible, on request)
- Single limit stop or double limit stop version

### Electro-hydraulic actuators

## Skilmatic range

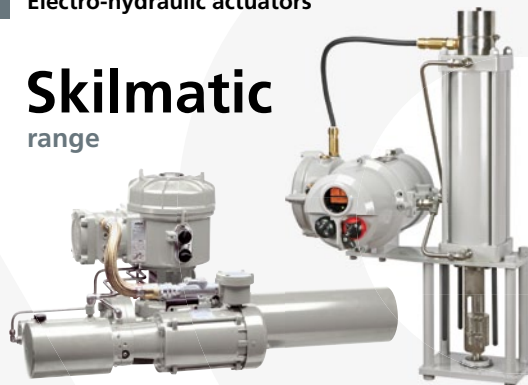

Skilmatic range SIL3 certified Intelligent, self-contained electro-hydraulic actuators feature Rotork double-sealed terminal compartments and user displays for position, pressure, diagnostics and fault indication.

- Linear thrusts: 1.7 to 5,500 kN (382 to 1,230,000 lbf)
- ¼ turn torques: 65 to 600,000 Nm (575 to 5,000,000 lbf.in)
- Two-position, ESD or modulating operation in spring-return or double-acting executions
- Single-phase, three-phase or 24 VDC power supply
- Non-intrusive infrared configuration and *Bluetooth*<sup>®</sup> data transfer
- Optional bus communications via all major protocols
- Partial stroke test capability
- Watertight or explosionproof ATEX, FM, CSA IEC and GOST



## Worldwide Service

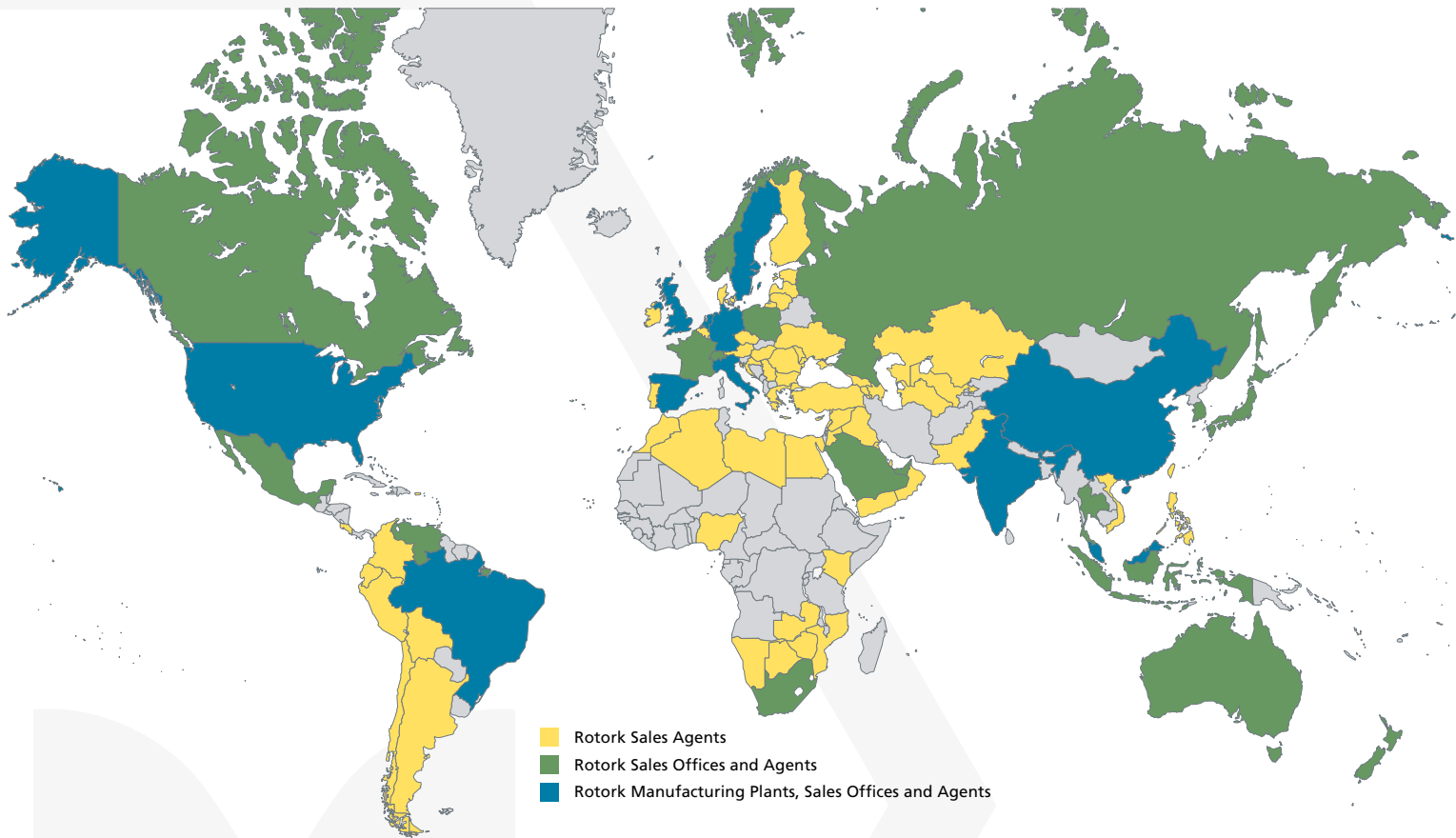

## **rotork®** Site Services

In each of our divisions, Site Services staff are dedicated to providing customer service and support, carrying out new installations and delivering retrofit projects. These teams are based out of service centres around the world and are complemented by factory-trained agents.

Our expert technicians support Rotork customers, allowing us to deliver on our promise of global solutions backed by local service.



# Damper Actuation Focused



Electric actuators with  
or w/o spring return



Switch boxes  
and position indicators

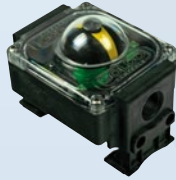

Manual operators



*One Air-Damper – Various Actuator Solutions!*

Temperature triggers  
for fire-dampers



Pneumatic actuators  
such as rack and pinion,  
scotch/yoke, vane,  
electro-hydraulic



Pneumatic control components  
and air preparation



Spring assembly



Positioners



Rotork  
hvac@rotork.com  
+49 9101 9081-26

**Schischek sales worldwide**



**Contact**

**Headquarter / Manufacturing**

Schischek GmbH  
 Mühlsteig 45  
 Gewerbegebiet Süd 5  
 90579 Langenzenn  
 Germany  
 Tel. +49 9101 9081-0  
 Fax +49 9101 9081-77  
 info-de@schischek.com  
 www.schischek.com



**Your local dealer**

**To find your local contact please visit:**  
[www.schischek.com/contact/schischek-worldwide](http://www.schischek.com/contact/schischek-worldwide)  
[www.rotork.com/en/contact/index/](http://www.rotork.com/en/contact/index/)

Technical changes, product discontinuations, literal errors and mistakes reserved.